

Features

Piezo buzzer

- Selectable continuous/intermittent sound, sound pressure: approx. 98±8dB (0.1m)
- Flashes green or red LED during operating buzzer
- Mounting hole: Ø22/25mm, max. panel thickness: 6mm
- IP65 protection structure (front panel)



Piezo buzzer



Magnetic buzzer

Magnetic buzzer

- Strong bass sound, selectable continuous/intermittent sound, sound pressure: approx. 87±10dB (0.1m)
- Flashes green or red LED during operating buzzer
- Mounting hole: Ø22/25mm, max. panel thickness: 6mm
- IP30 protection structure (front panel)

Melody buzzer

- Selectable melody among 4 types and adjustable sound pressure, sound pressure: approx. 105dB (0.1m)
- Flashes red LED during operating buzzer
- Mounting hole: Ø66mm
- IP65 protection structure (front panel)
- One-touch screwless connection with end sleeve (ferrule) crimp terminal



Melody buzzer

 Please read "Safety Considerations" in operation manual before using this unit.



Specifications

Items	Piezo buzzer		Magnetic buzzer		Melody buzzer		
Model	B2PB-B1D	B2PB-B1D-R	B2NB-B1D	B2NB-B1D-R	B6MA-4GD□ ^{*1}	B6MA-4GL□ ^{*1}	
Power supply	12-24VDC=				12-24VDC=	110-220VAC~ 50/60Hz	
Power consumption	Max. 0.6W		Max. 1.5W		Max. 3W	Max. 5W	
Sound pressure	Approx. 98±8dB (0.1m) ^{*2}		Approx. 87±10dB (0.1m) ^{*2}		Max. 105dB (0.1m), max. 95dB (1m)		
Sound type	Continuous sound, intermittent sound				4 types (ambulance, police, ringtone, for elise) ^{*3}		
Mounting hole	Ø22/25mm compatible				Ø66mm		
Operation indicator	Green LED	Red LED	Green LED	Red LED	Red LED		
Insulation resistance	Over 1,000MΩ (at 500VDC megger)		Over 50MΩ (at 500VDC megger)		Over 1,000MΩ (between all terminals and case at 500VDC megger)		
Dielectric strength	500VAC 50/60Hz for 1 min (between all terminals and case)		1,000VAC 50/60Hz for 1 min (between all terminals and case)		500VAC 50/60Hz for 1 min (between all terminals and case)	2,000VAC 50/60Hz for 1 min (between all terminals and case)	
Vibration	0.75mm amplitude at frequency of 10 to 55Hz (for 1 min) in each X, Y, Z direction for 1 hour				0.75mm amplitude at frequency of 10 to 55Hz (for 1 min) in each X, Y, Z direction for 2 hours		
Shock	500m/s ² (approx. 50G) in each X, Y, Z direction for 3 times						
Environment	Ambient temperature	-15 to 55°C, storage: -25 to 65°C				-10 to 55°C, storage: -20 to 65°C	
	Ambient humidity	35 to 85%RH, storage: 35 to 85%RH					
Protection structure	IP65 (front panel)		IP30 (front panel)		IP65 (front panel)		
Material	Body	Polyamide 6				Polycarbonate	
	Cap	Polycarbonate				Polycarbonate	
Tightening torque	4.08 to 6.12kgf·cm (0.4 to 0.6N·m)						
Approval							
Weight	Approx. 305g (approx. 18g) ^{*4}		Approx. 214g (approx. 14g) ^{*4}		Approx. 170g (approx. 130g) ^{*5}		

※1. □ indicates input type: N (NPN open collector input), P (PNP open collector input)

※2. It is rated at power supply 24VDC. (Sound pressure may be decreased when using 12VDC.)

※3. You may sample the melodies at www.autonics.com.

※4. The weight is for 10 units including packaging. The weight in parenthesis is for a single unit.

※5. The weight includes packaging. The weight in parenthesis is for unit only.

※Environment resistance is rated at no freezing or condensation.

Dimensions

Piezo buzzer

(unit: mm)

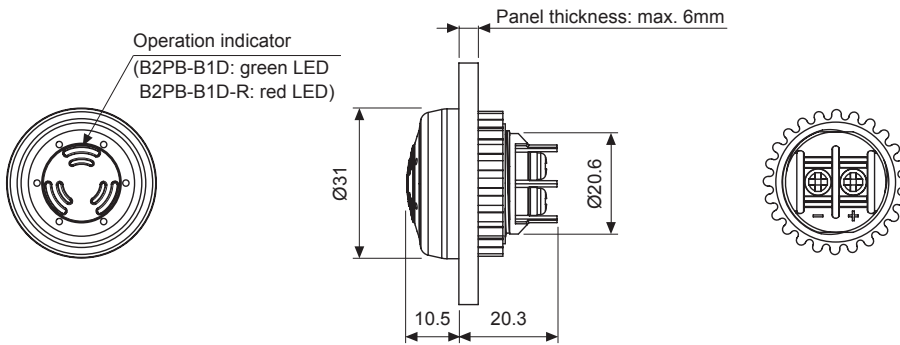

Magnetic buzzer

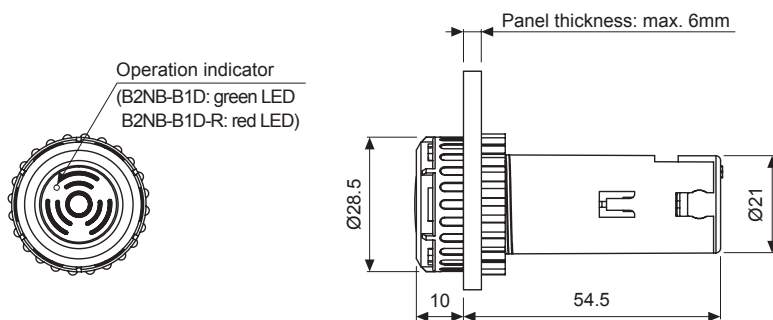

Melody buzzer

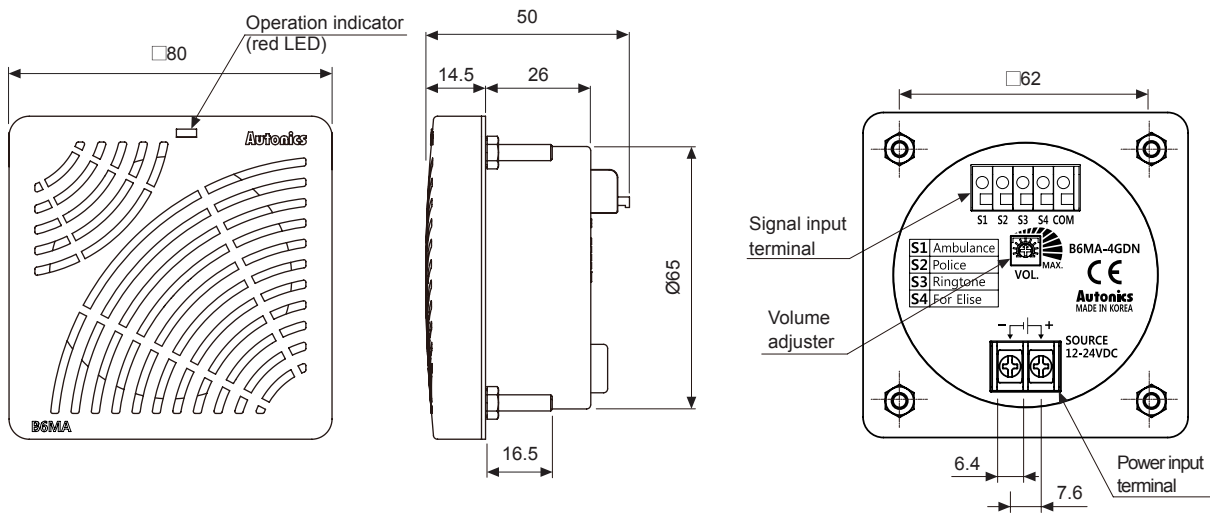

Panel cut-out dimensions

Piezo buzzer/Magnetic buzzer

<Mounting hole: Ø25>

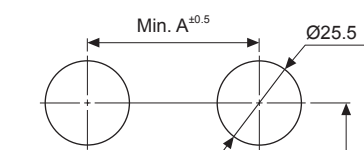

<Mounting hole: Ø22>

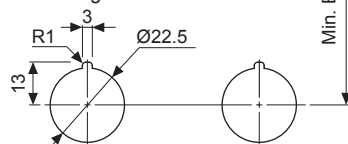

Item	A	B
Piezo buzzer	50	50
Magnetic buzzer	50	50

Melody buzzer

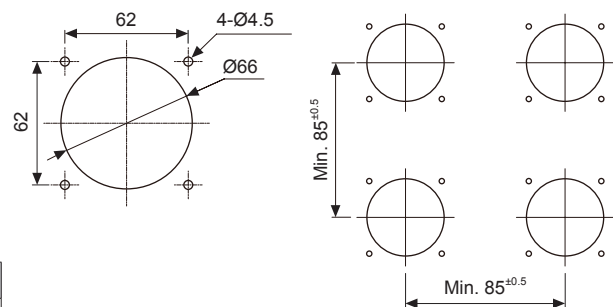

Control Switches

Ø16

Ø22/25

Ø30

□30

Push Button Switches

Round

Square

Rectangular

Selector Switches

Round

Square

Rectangular

Key Selector Switches

Round

Square

Rectangular

Double Push Button Switches

Mushroom-head Push Button Switches

Emergency Switches

Pilot Lights

Accessories

Buzzers

Setting Buzzer Type

Piezo buzzer

1. Continuous sound

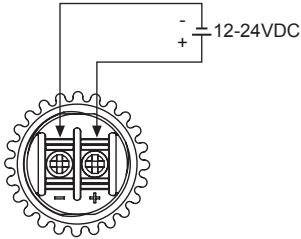

2. Intermittent sound

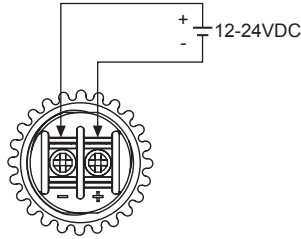

Magnetic buzzer

1. Remove the bottom cover from the buzzer.

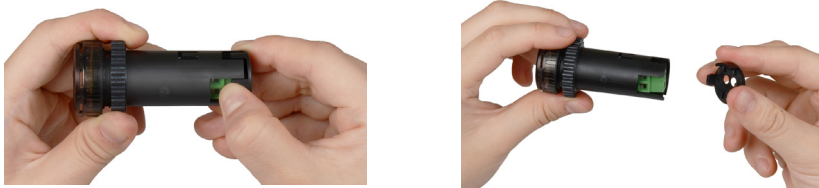

2. Remove the jumper pin using a flat-head (-) screwdriver.



※Buzzer type: continuous sound: beep————, intermittent sound: beep-, beep-
 Jumper pin attached: intermittent sound
 Jumper pin removed: continuous sound

Melody buzzer

Connect the COM terminal and the desired melody terminal with end sleeve (ferrule) crimp terminal.

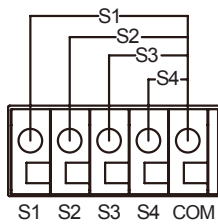

No.	Terminals	Melody type
1	COM-S1	Ambulance
2	COM-S2	Police
3	COM-S3	Ringtone
4	COM-S4	For elise

※You may sample the melodies at www.autonics.com.

※Easy adjustment of the melody volume with a cross-head (+) screwdriver

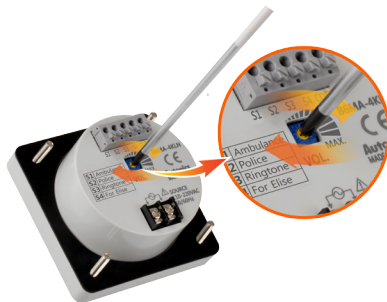

※Convenient wiring: one-touch screwless connection with end sleeve (ferrule) crimp terminal

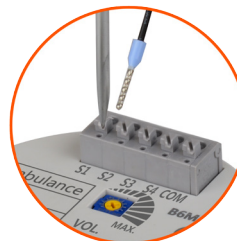

Control Switches

Ø16

Ø22/25

Ø30

□30

Push Button Switches

Round

Square

Rectangular

Selector Switches

Round

Square

Rectangular

Key Selector Switches

Round

Square

Rectangular

Double Push Button Switches

Mushroom-head Push Button Switches

Emergency Switches

Pilot Lights

Accessories

Buzzers

