

Modbus I/O Module

WMB Series NEW



Multiple Analog input signals to RS-485 (Modbus RTU) communication!

1. Multi Ch input

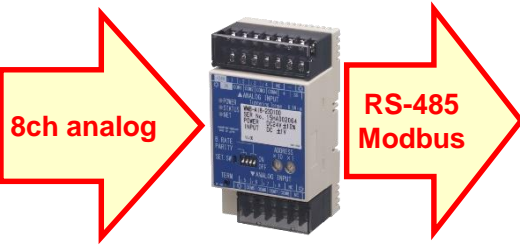

WMB-AI8

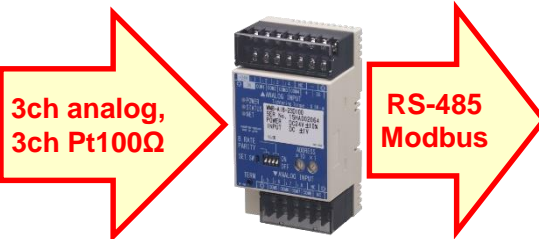

WMB-MAI8

2. Compact Size

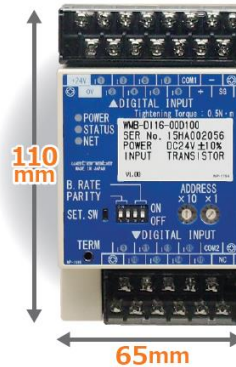

3. Easy wiring

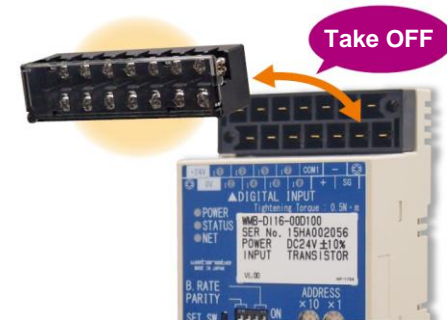

WMB Series Line-up

- Analog input module
WMB-AI8 (Analog input 8ch)
- Analog / RTD input module
WMB-MAI6 (Analog input 3ch, Pt100Ω input 3ch)

WMB Application ①

Monitoring and diagnosis of deterioration of hoist crane

Current load data is used for burn-in prevention and deterioration diagnosis of the hoist motor.
In addition, the deflection state of the crane can also be routinely managed.

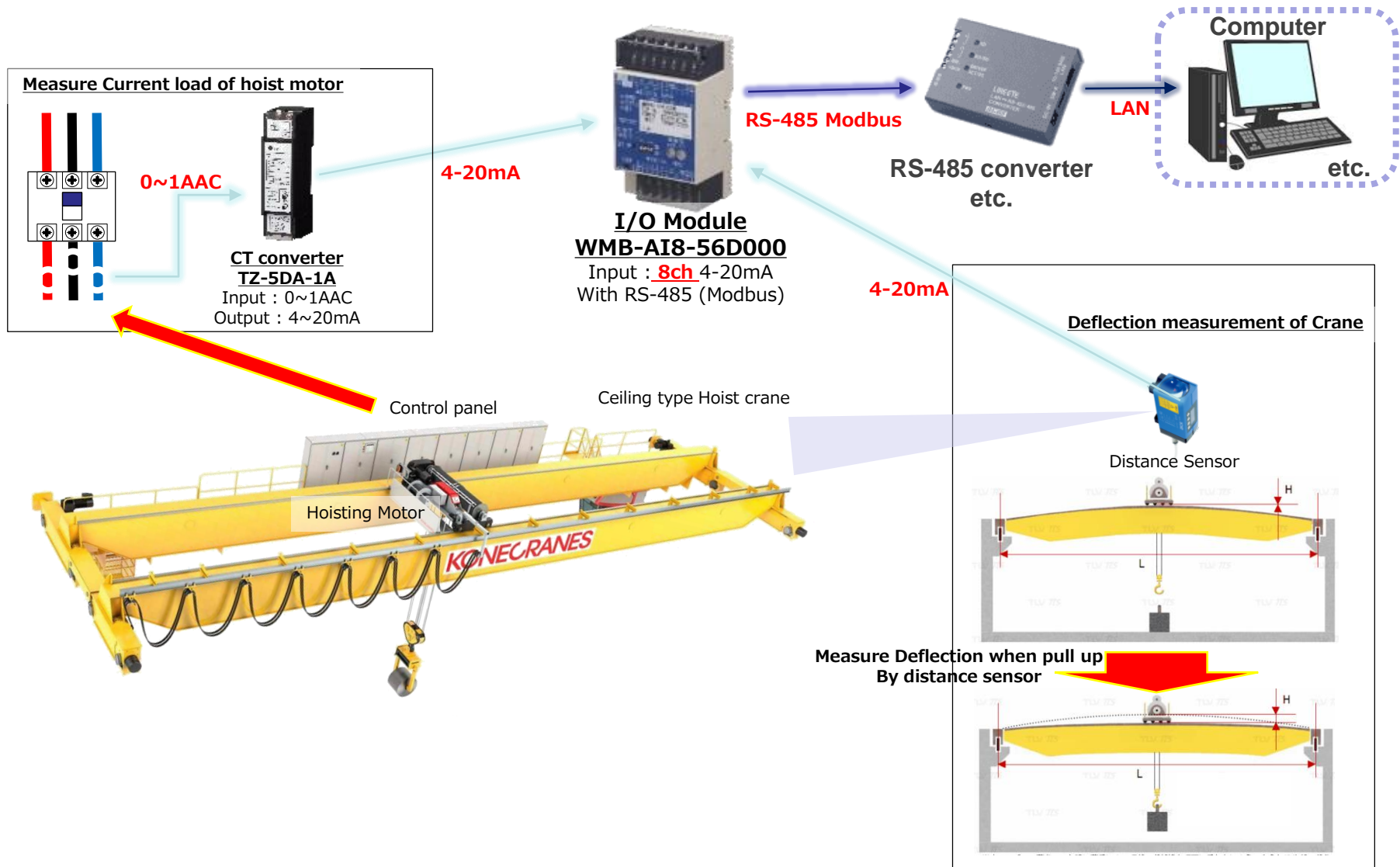

WMB Application ②

1) Current system (converter)

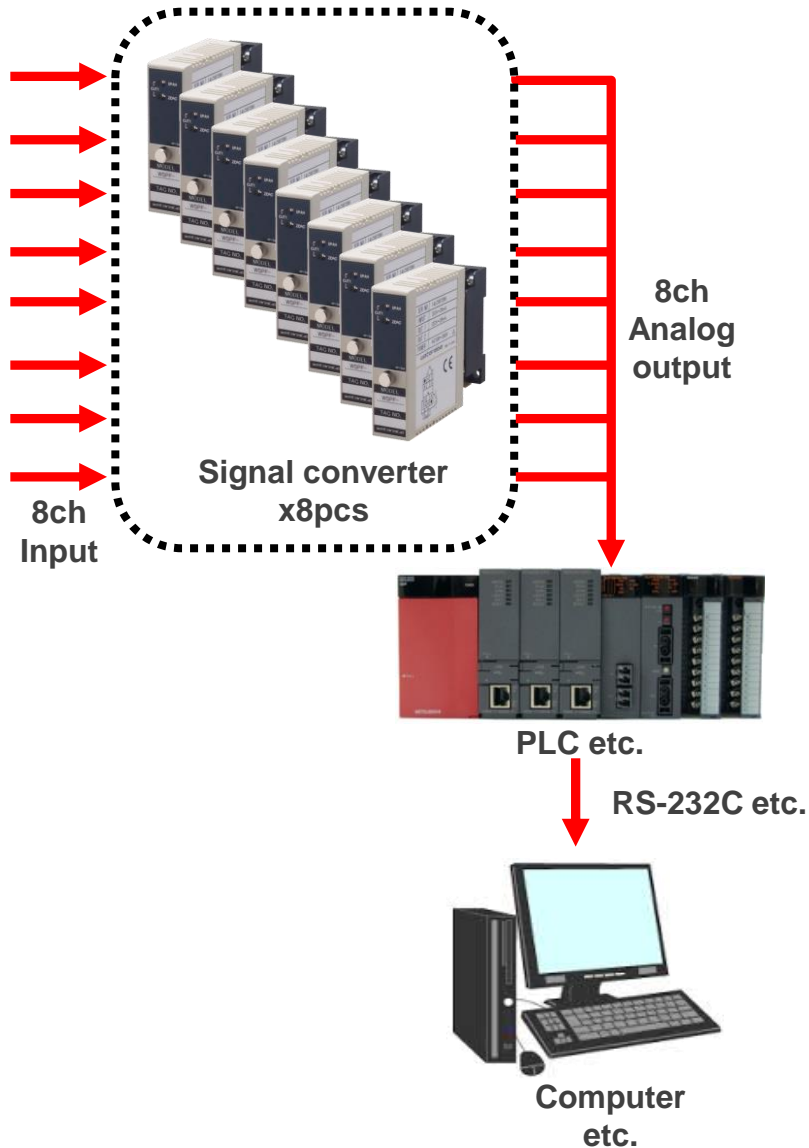

2) In case WMB-AI8

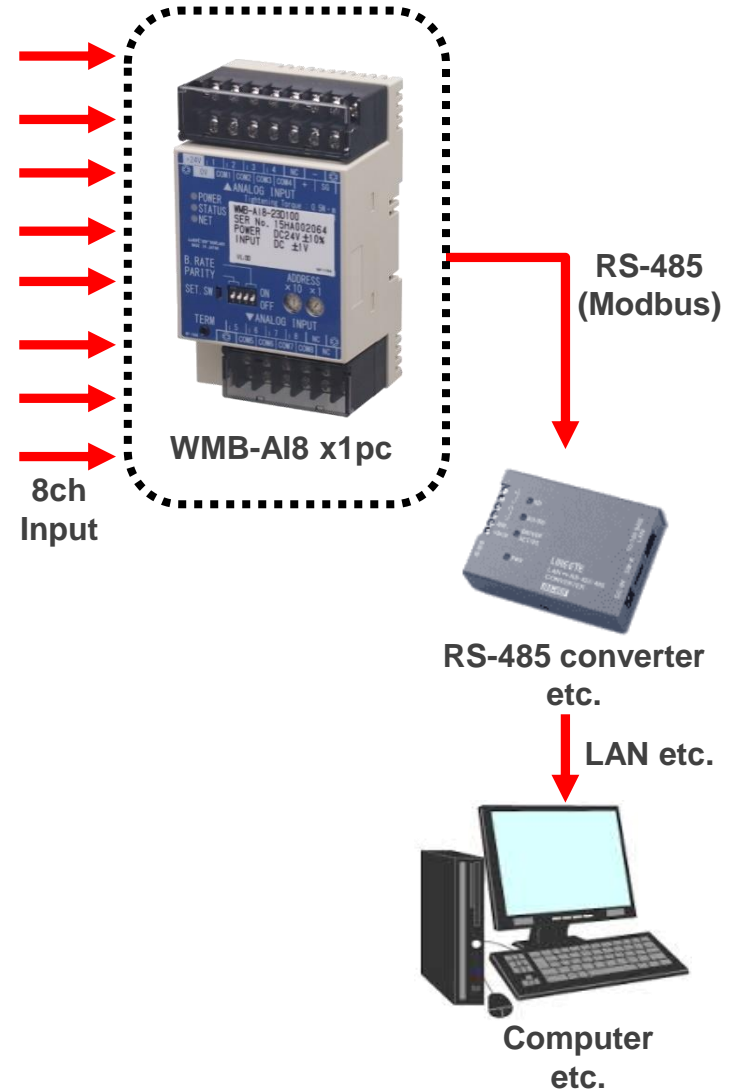

WMB Application ③



Ethernet etc.

RS-485
converter
etc.

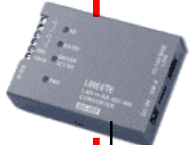

Distance up to 500m

RS-485 (Modbus RTU)

WMB 1

2

3

30

31



WMB series
1 to n
(up to 31pcs)

[Analog input 8ch] or [Analog input 3ch] & [RTD input 3ch]

WMB Application ④

