

**New Product**

Graphical Panel Meter  
**WPMZ** Series



Evolution of Digital Panel Meter  
The Highest Usability for Production Site

DC Voltage / Current Meter  
**WPMZ-1** New Product

Strain Gauge Meter  
**WPMZ-3** New Product

Rotation / Speed Meter  
**WPMZ-5**

Flow Rate / Flow Totalizer  
**WPMZ-6**

Graphical Panel Meter

**WPMZ** Series

*watanabe*

## Evolution of Digital Panel Meter

# The Highest Usability for Production Site

Watanabe developed WPMZ series as multi-display digital panel meter matched to the user's needs, and focused on the basic performance such as [1. Easy to read] [2. Easy to use].

WPMZ has below 4 series. It is a product that can cover various requirements, such as process monitoring, quality judgement etc. at the manufacturing site for various applications and environment.

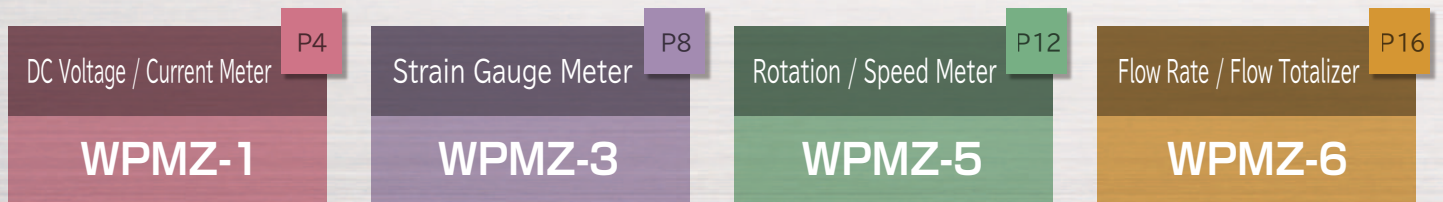

## 1. Easy to read

### High-brightness and sharp display to read small letters

2.4 inch high brightness TFT full-color LCD.

WPMZ has 5 level brightness setting to adjust according to the indoor / outdoor lighting of site.

Also 4 high visibility background color can be set in case of alarm output is ON.

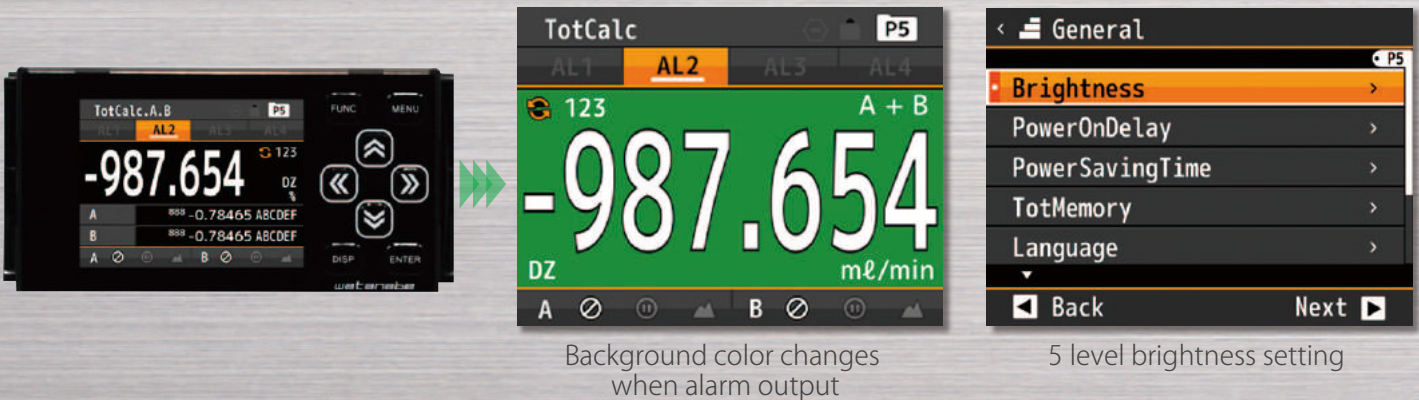

### 90° Display rotation is effective to use narrow places of board

There is a function to rotate display 90°.

Also able to change key assignment of cross keys.



Vertical display



Graphical Digital Panel Meter

# WPMZ Series

## 2. Easy to use

Numerical display and graph display selectable according to the measurement purpose

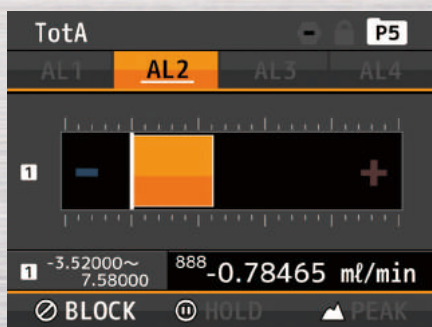

Shows ratio by Bar graph

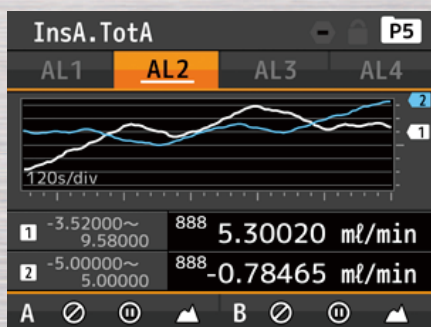

Shows trend by Trend graph

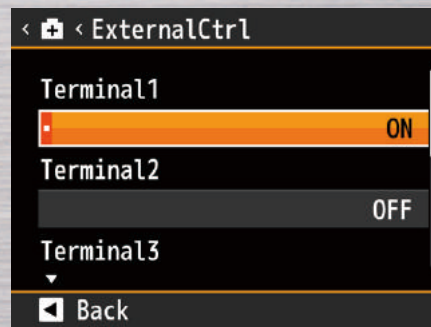

Self-diagnostics function to prevent connection trouble



Simple settings by Cross-key

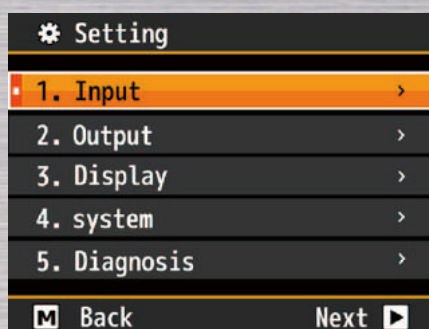

English Menu

## 10 Arithmetic expression for 2 input calculation

Measurement value or calculation result can display 1 to 3 elements in one display. (Display below)

You can select 10 kinds of arithmetic expression for Ach & Bch calculation. (List at right)

Arithmetic expression can be easily set by cross-keys. 2ch display saves install space.



1 element display



2 element display

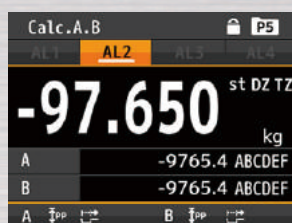

3 element display

### Arithmetic expression for 2 input calculation

Function	Arithmetic expression
Addition	$((A + B) + C) \times K$ or $(A + B) \times K + C$
Subtraction	$((B - A) + C) \times K$ or $(B - A) \times K + C$
Multiplication	$((A \times B) + C) \times K$ or $(A \times B) \times K + C$
Division	$((B / A) + C) \times K$ or $(B / A) \times K + C$
Average	$((A + B) / 2) + C) \times K$
HighSelect	$((\text{Larger of A and B}) + C) \times K$
LowSelect	$((\text{Smaller of A and B}) + C) \times K$
Difference	$((\text{Abs of } (B - A)) + C) \times K$
RelaticeError	$((A / B) - 1) \times K$
Density	$(B / (A + B)) \times K$

\* In case WPMZ-1/3

## DC Voltage / Current Measurement

# WPMZ-1

- DC Voltage / Current input
- High-speed sampling rate (1ch : 4000 times/sec, 2ch : 2000 times/sec)
- Alarm log function

[WPMZ-1] is for measuring DC voltage / Current, and it is especially suited for High-speed sampling on the production line in factory manufacturing process. We recommend using at parts inspection for shortening the inspection process by NG judgement and clearance judgement etc.

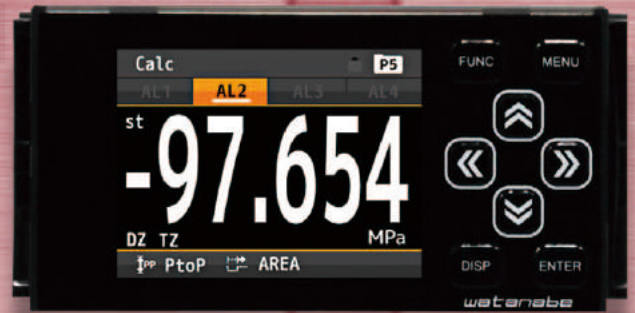

### Application examples

#### Calculation function + Alarm log function

Can be used for Capacitor lead length detection!

Input signals (Ach, Bch) from the sensor to WPMZ-1. Able to detect capacitor lead length by using calculation function (A-B). Also, WPMZ-1 has alarm log function to keep trend data before and after alarm of comparison judgement.

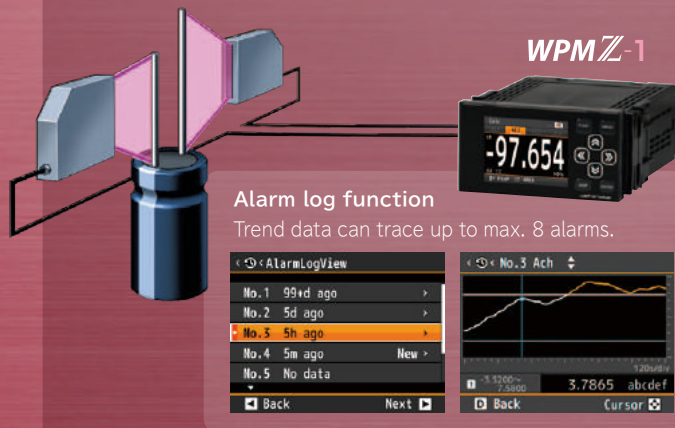

#### High-speed sampling

Small change of value can be measured!

High-speed sampling of max. 4000 times/sec with 1ch input, and max. 2000 times/sec with 2ch input, by  $\Delta\Sigma$  modulation. Capture changes in instantaneous values such as press management and torque management.

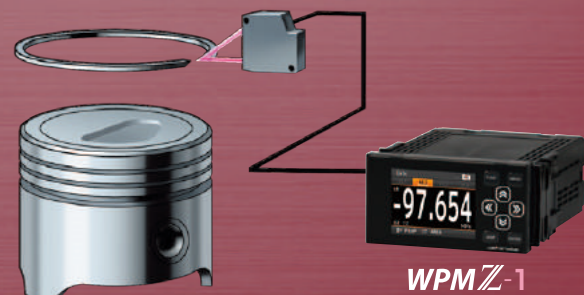

### Main Specifications

#### Power supply

- 100~240VAC  $\pm 10\%$
- 12VDC  $\pm 10\%$
- 24~48VDC  $\pm 10\%$

#### Input : Ach/Bch

- DC Voltage / Current input (Process input)

#### Option output

- Analog output
- BCD output (Open collector NPN / PNP)
- RS-232C
- RS-485 (Modbus RTU)

#### Comparator output (AL1~AL4)

- Open collector output (NPN / PNP)
- Relay output (Normally open)



## Features

- Easy to read by 2.4 inch TFT Full color LCD display
- High-speed sampling rate  
(1ch : Max. 4000 times/sec, 2ch : Max. 2000 times/sec)
- Alarm log function up to 8 alarm trend data
- [Value], [Bar graph] and [Trend graph] Display can be selected according to the measurement
- Standard 1ch input type, and also 2ch input type which can use for special measurement

## Model

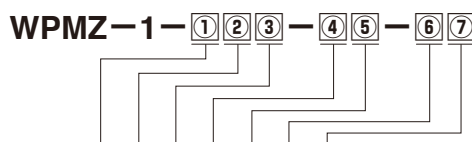

Series	① Power supply	② Input Ach	③ Input Bch	④ Option output	⑤ Comparator output	⑥ Test report	⑦ Suffix code	Description
WPMZ-1								DC Voltage / Current measurement
	1							Power supply : 100 to 240VAC ±10%
	3							Power supply : 12VDC ±10%
	4							Power supply : 24 to 48VDC ±10%
		1						± 99.999mVDC
		2						± 999.99mVDC
		3						± 9.9999VDC
		5						± 99.999μADC
		6						± 999.99μADC
		7						± 9.9999mADC
		B						Process input (DC Voltage / Current)
			X					None
			1					± 99.999mVDC
			2					± 999.99mVDC
			3					± 9.9999VDC
			5					± 99.999μADC
			6					± 999.99μADC
			7					± 9.9999mADC
			B					Process input (DC Voltage / Current)
				X				Display only (External control)
				1				Analog output
				2				BCD output (Open collector NPN)
				3				BCD output (Open collector PNP)
				4				RS-232C output
				5				RS-485 output (Modbus RTU)
					E			Open collector output (NPN) (AL1~AL4)
					F			Open collector output (PNP) (AL1~AL4)
					R			Relay output (Normally open) (AL1~AL4)
						X		Without Test report
						T		With Test report
							00	Japanese default setting
							E0	English default setting

## Input Specifications

Ach input (1ch) / Bch input (2ch)

DC Voltage input

Code	Measurement range	Input resistance	Max. allowable input	Accuracy
1	± 99.999mV	Approx. 1MΩ	± 10V	± (0.05% of FS + 1digit)
2	± 999.99mV		± 100V	
3	± 9.9999V		± 100V	

DC Current input

Code	Measurement range	Input resistance	Max. allowable input	Accuracy
5	± 99.999uA	Approx. 1kΩ	± 1mA	± (0.1% of FS + 1digit)
6	± 999.99uA	Approx. 100Ω	± 10mA	
7	± 9.9999mA	Approx. 10Ω	± 50mA	

Process input (DC Voltage / Current)

Code	Measurement range	Input resistance	Max. allowable input	Accuracy
B	± 5V	Approx. 1MΩ	± 100V	± (0.05% of FS + 1digit)
	0~5V			
	1~5V			
	± 10V	Approx. 10Ω	± 50mA	
	0~10V			
	± 20mA			
0~20mA				
4~20mA				

A/D conversion ΔΣ conversion

Input Configuration Single ended

Sampling rate 1ch input model : Max. 4000 times/sec

2ch input model : Max. 2000 times/sec

## Common Specifications

Measurement channel	1ch or 2channels
Display	2.4 inch TFT LCD 1ch input : Measurement results of Ach input 2ch input : Either measurement results of Ach input, measurement results of Bch input, or calculation results Measurement results of Ach and Bch input Measurement results and calculation results of Ach or Bch input
Display range	- 99999 to 99999
Zero display	Leading zero suppression
Decimal point	Arbitrary setting possible
Over range warning	OVER or -OVER when input range or display range is exceeded
Operating temp & humidity range	-5 to 50 °C, 35 to 85% RH (No condensation)
Storage temp & humidity range	-10 to 70 °C, 60% RH or less
Power supply	100 to 240VAC ±10% 50/60 Hz 12VDC ±10% 24 to 48 VDC ±10%
Power consumption	10VA (100VAC), 14VA (240VAC), 6W (12VDC), 6W (24VDC), 6.5W (48VDC)
Sensor power supply	12VDC ±10% 100mA max. / 24VDC ±10% 50mA max. *When 2channel input, allowable current of Ach and Bch together will be above current. *1.2W max. when the combination of 12VDC and 24VDC
Dimensions	96mm(W) x 48mm(H) x 145mm(D), 1/8 DIN size
Weight	Approx. 350g
Withstand voltage	AC power supply : 3000VAC for 1 minute: Between the power supply terminal - input / external control / comparator output / option output DC power supply : 1500VAC for 1 minute: Between the power supply terminal - input / external control / comparator output / option output AC/DC power supply : 1500VAC for 1 minute: Between the input terminal - external control / comparator output / option output
Insulation resistance	100MΩ (500VDC) or more between the above terminals
Protection	IP66 (Front bezel)
Rated altitude	2000m or less
Measurement category	II
Contamination level	2
Applicable EN standard	EN61326-1 (EMS : Industrial installations; EMI : Class A) *Applies to wire length of 30m or less EN61010-1 EN50581
Case material / color	Polycarbonate, Black UL94V-0

## External control

\*Execute by COM terminal short circuit

<b>Compare reset</b>	Turns OFF comparator output monitor and comparator output
<b>Display hold</b>	Holds the display value
<b>Peak hold</b>	Holds the max. value
<b>Bottom hold</b>	Holds the min. value
<b>Amplitude Hold</b>	Holds the difference between max. and min. value
<b>Deviation hold</b>	Holds the display value that has the max. absolute value of difference from reference value
<b>Average hold</b>	Stabilize display by additional moving average for the set number of times
<b>Hold reset</b>	Reset hold state of display value
<b>Digital zero</b>	Set the display value to zero value
<b>Display change</b>	Changes the measurement display
<b>Trend log</b>	Acquire alarm log
<b>Pattern select</b>	Changes the setting patterns (Max. 8 pattern)

\*Each function can be assigned to control terminal 1 to 5.

## Option Specifications

### Comparator output

<b>Output method</b>	Open collector output or Relay output
● <b>Open collector output</b>	Rated output NPN : Sinc current Max. 50mA PNP : Source current Max. 50mA Applied voltage Max. 30V Output saturation voltage 1.2V or less at 50mA
● <b>Relay output</b>	Contact rating : 250VAC 2A, 30VDC 2A Mechanical life : 20,000,000 times Electrical life : 100,000 times
<b>Control method</b>	Microcomputer operation method
<b>Setting range</b>	-99999 to 99999
<b>Hysteresis</b>	1 to 99999 digit for each setpoints
<b>Comparison condition</b>	Condition can be set to AL1 to AL4 independently
● <b>Level judgement mode</b>	The alarm is ON when display value exceeds setpoint (Over alarm) The alarm is ON when display value is under setpoint (Under alarm)

#### Over alarm (Upper limit judgement)

Comparison condition	Result
Display value > AL1 judgement value	AL1
Display value > AL2 judgement value	AL2
Display value > AL3 judgement value	AL3
Display value > AL4 judgement value	AL4

#### Under alarm (Lower limit judgement)

Comparison condition	Result
AL1 judgement value > Display value	AL1
AL2 judgement value > Display value	AL2
AL3 judgement value > Display value	AL3
AL4 judgement value > Display value	AL4

● <b>Zone judgement mode</b>	The alarm is ON when between upper and lower judgement values (Inside zone) The alarm is ON when out of upper and lower judgement values (Outside zone)
------------------------------	--

#### Inside zone alarm

Comparison condition	Result
AL1 zone HI $\geq$ Display value $\geq$ AL1 zone LO	AL1
AL1 zone HI $\geq$ Display value $\geq$ AL2 zone LO	AL2
AL1 zone HI $\geq$ Display value $\geq$ AL3 zone LO	AL3
AL1 zone HI $\geq$ Display value $\geq$ AL4 zone LO	AL4

#### Outside zone alarm

Comparison condition	Result
Display value > AL1 zone HI or AL1 zone LO > Display value	AL1
Display value > AL2 zone HI or AL2 zone LO > Display value	AL2
Display value > AL3 zone HI or AL3 zone LO > Display value	AL3
Display value > AL4 zone HI or AL4 zone LO > Display value	AL4

#### ● Difference judgement mode

\*Alarm is ON when the (Max.-Min.) during the fixed time exceeds the change judgement value.

Comparison condition	Result
(Max.-Min.) during the fixed time $\geq$ AL1 judgement value	AL1
(Max.-Min.) during the fixed time $\geq$ AL2 judgement value	AL2
(Max.-Min.) during the fixed time $\geq$ AL3 judgement value	AL3
(Max.-Min.) during the fixed time $\geq$ AL4 judgement value	AL4

## Analog output

\*Select either Ach, Bch or calculation results to be output.

<b>Conversion method</b>	D/A conversion method
<b>Resolution capability</b>	Equivalent of 13bit
<b>Scaling</b>	Digital scaling
<b>Response speed</b>	Up to 300 $\mu$ s (0 $\rightarrow$ 90% response)
<b>Specifications for each output</b>	Refer to the following chart.

Output type	Load resistance	Accuracy (23 $\pm$ 5 $^{\circ}$ C 35~85%RH)	Ripple
0~10V	$\geq$ 2k $\Omega$	$\pm$ 0.1% FS	$\pm$ 50mV <sub>p-p</sub>
-10~10V			
1~5V			
0~20mA	$\leq$ 500 $\Omega$		$\pm$ 25mV <sub>p-p</sub>
4~20mA			

\*Ripple for current output is at load resistance 250 $\Omega$  (20mA output)

## BCD Output

\*Select either Ach, Bch or calculation results to be output.

<b>Output type</b>	Open collector output, NPN/PNP type
<b>Measurement data</b>	Negative logic. Transistor ON when logic is "1"
<b>Polarity signal</b>	Negative logic. Transistor ON when negative display
<b>Over signal</b>	Negative logic. Transistor ON when over display
<b>Print command signal</b>	Transistor ON for fixed period when data conversion
<b>Transistor capacity</b>	Voltage 30V max., Current 10mA max. Output saturation voltage $\leq$ 1.2V at 10mA
<b>Enable</b>	Output transistor turns OFF when the enable terminal is short with D.COM

## RS-232C communication

<b>Communication protocol</b>	Modbus RTU*, Original command, Original output
<b>Synchronous system</b>	Asynchronous mode
<b>Communication method</b>	Full duplex
<b>Communication speed</b>	9600bps, 19200bps, 38400bps
<b>Data length</b>	7bit, 8bit
<b>Stop bit</b>	1bit, 2bit
<b>Parity bit</b>	None, Odd, Even
<b>Delimiter</b>	CR, CR+LF
<b>Character code</b>	ASCII
<b>Transmission control procedure</b>	Non-procedure
<b>Signal name</b>	TXD, RXD, SGI
<b>No. of connectable units</b>	1 unit
<b>Line length</b>	15m

\*No data length / stop bit / delimiter settings when Modbus RTU protocol

## RS-485 communication

<b>Communication protocol</b>	Modbus RTU
<b>Synchronous system</b>	Asynchronous mode
<b>Communication method</b>	2-wire half duplex
<b>Communication speed</b>	9600bps, 19200bps, 38400bps
<b>Data length</b>	8bit
<b>Stop bit</b>	1bit, 2bit
<b>Parity bit</b>	N/A, odd number, even number
<b>Signal name</b>	Non-inverting (+), inverting (-)
<b>No. of connectable units</b>	31 units
<b>Line length</b>	1.2km max (Total)

## Terminal Connections

### Lower terminal

(External control / comparator output / power supply)

- Comparator output / External control

Compatible wire : AWG24 to 16  
(Open collector output)

\*⑥⑦⑧ are connected inside the product.

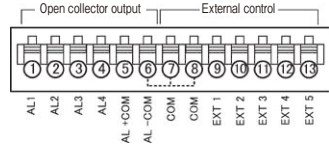

(Relay output)

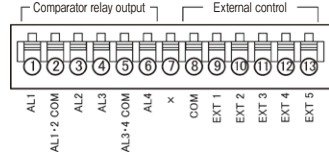

- Power supply

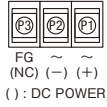

### Upper terminal

(Input / GO output / sensor power supply)

- DC voltage input / GO output

Compatible wire : AWG24 to 16  
(Ach DC voltage input)

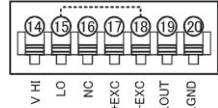

\*⑮⑯ are connected internally

(Bch DC voltage input)

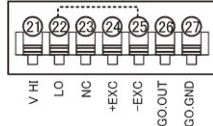

\*⑳㉑ are connected internally

- DC current input / GO output

Compatible wire : AWG24 to 16  
(Ach DC current input)

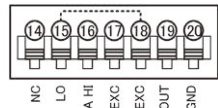

\*⑮⑯ are connected internally

(Bch DC current input)

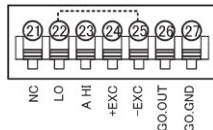

\*⑳㉑ are connected internally

- Process signal input / GO output

Compatible wire : AWG24 to 16  
(Ach Process signal input)

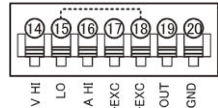

\*⑮⑯ are connected internally

(Bch Process signal input)

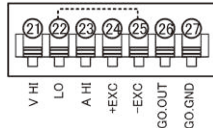

\*⑳㉑ are connected internally

### Middle terminal (Option output)

- Analog output

Compatible wire : AWG24 to 16

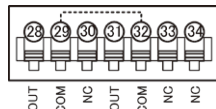

\*⑳㉑ are connected internally

- RS-232C

Compatible wire : AWG24 to 16

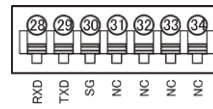

- RS-485

Compatible wire : AWG24 to 16

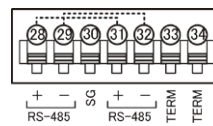

\*⑳㉑ are connected internally

- BCD

Compatible wire : AWG28 flat cable (1.27mm)

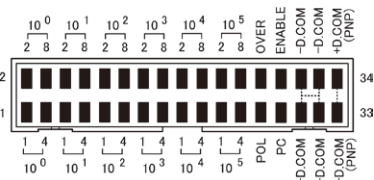

## Dimensions

(1/8 DIN size)

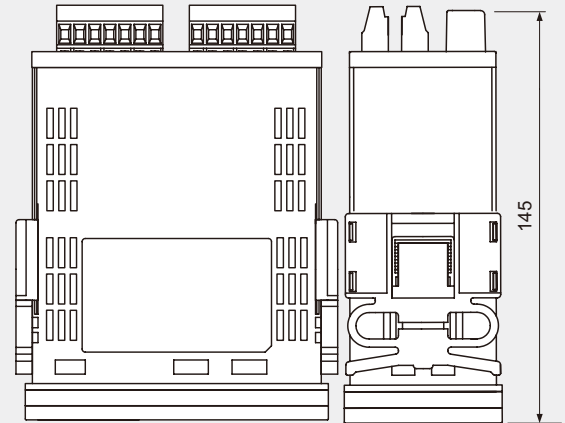
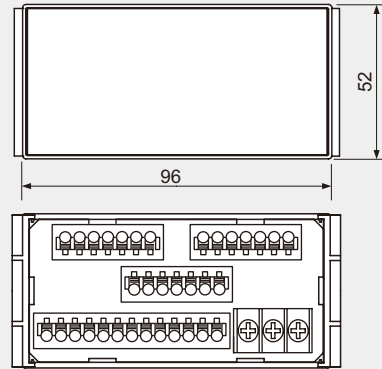

Unit : mm

## Panel cutout

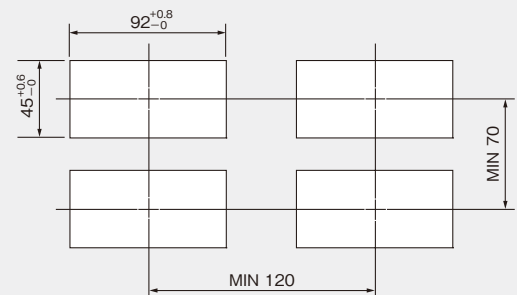

\* Recommended panel thickness : 0.8 to 5.0mm

# Strain Gauge Measurement

# WPMZ-3

- Strain Gauge input
- Wave compare, Multi hold function
- High-speed sampling rate (1ch : 4000 times/sec, 2ch : 2000 times/sec)

[WPMZ-3] is for measuring strain gauge, and it has wave compare and multi hold function.

It is suitable for Process control, Quality control and traceability etc. at the manufacturing site where mass production is carried out with constant cycle.



## Application examples

### Wave compare mode

Alarm output and waveform log function by comparing measurement waveform and comparison waveform

### Multi hold mode

Outputs each compare result for each hold value of each section and the comparison judgement setting value.

### Judgement waveform creation

Function to create judgement waveform necessary for comparison

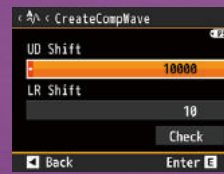

NG judgement

### Alarm output

Output alarm as 'NG' judgement if there is more than 1 measured point which is out of judgement waveform

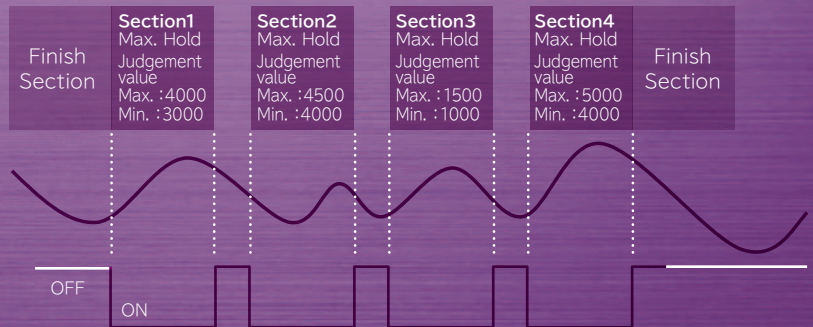

### Display Example

Displays the hold value in each section with the current measurement value. Icons will appear according to the hold detail section switching method.



## Main Specifications

### Power supply

- 100~240VAC ±10%
- 12VDC ±10%
- 24~48VDC ±10%

### Input : Ach/Bch

- Strain gauge input
- DC Voltage / Current input (Process input)

### Option output

- Analog output
- BCD output (Open collector NPN / PNP)
- RS-232C
- RS-485 (Modbus RTU)

### Comparator output (AL1~AL4)

- Open collector output (NPN / PNP)
- Relay output (Normally open)





## Features

- Easy to read by 2.4 inch TFT Full color LCD display
- High-speed sampling rate  
(1ch : Max. 4000 times/sec, 2ch : Max. 2000 times/sec)
- Alarm log function up to 8 alarm trend data
- Wave compare function in 48 x 96mm size (1/8 DIN size)
- 8 types of hold method and 4 section Multi hold function
- [Value], [Bar graph] and [Trend graph] Display can be selected according to the measurement
- Standard 1ch input type, and also 2ch input type which can use for special measurement

## Model

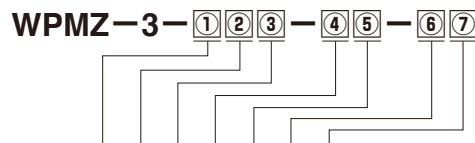

Series	① Power supply	② Input Ach	③ Input Bch	④ Option output	⑤ Comparator output	⑥ Test report	⑦ Suffix code	Description
WPMZ-3								Strain gauge measurement
	1							Power supply : 100 to 240VAC ±10%
		3						Power supply : 12VDC ±10%
			4					Power supply : 24 to 48VDC ±10%
				S				Strain gauge input
					B			DC Voltage / Current input (Process input)
						X		None
							S	Strain gauge input
							B	DC Voltage / Current input (Process input)
							X	Display only (External control)
							1	Analog output
							2	BCD output (Open collector NPN)
							3	BCD output (Open collector PNP)
							4	RS-232C output
							5	RS-485 output (Modbus RTU)
							E	Open collector output (NPN) (AL1~AL4)
							F	Open collector output (PNP) (AL1~AL4)
							R	Relay output (Normally open) (AL1~AL4)
							X	Without Test report
							T	With Test report
							00	Japanese default setting
							E0	English default setting

## Input Specifications

Ach input (1ch) / Bch input (2ch)

Strain gauge input

Bridge power supply	Adjustment range of gain	Measurement range	Calibration accuracy (at 23±5°C 35~85%RH)	Nonlinearity (at 23±5°C 35~85%RH)
5V	1mV/V~ 3.5mV/V	-3.5mV/V~ 3.5mV/V	±(0.1% of FS + 1digit)	±(0.02% of FS + 1digit)
10V				
2.5V				

A/D conversion  
Bridge voltage

ΔΣ conversion  
DC5V ±10% 60mA  
\*Up to four 350Ω load cells can be connected  
DC10V ±10% 30mA  
DC2.5V ±10% 30mA  
\*1.2W max. in the case of combination with DC voltage / current input (Process input)

Temperature characteristic  
Applicable sensor  
Sampling rate

100ppm/°C  
350Ω Strain gage type sensors  
1ch input model : Max. 4000 times/sec  
2ch input model : Max. 2000 times/sec

DC Voltage / Current input (Process input)

Measurement range	Input resistance	Max. allowable input	Accuracy (at 23±5°C 35~85%RH)
±5V	Approx. 1MΩ	±100V	±(0.05% of FS + 1digit)
0~5V			
1~5V			
±10V			
0~10V	Approx. 10Ω	±50mA	
±20mA			
0~20mA			
4~20mA			

A/D conversion  
Input Configuration  
Sampling rate

ΔΣ conversion  
Single ended  
1ch input model : Max. 4000 times/sec  
2ch input model : Max. 2000 times/sec

Sensor power supply

12VDC ±10% 100mA max. / 24VDC ±10% 50mA max.  
\*When 2channel input, allowable current of Ach and Bch together will be above current.  
\*1.2W max. when the combination of 12VDC and 24VDC  
\*1.2W max. when the combination of Strain gauge input

## Common Specifications

Measurement channel  
Display

1ch or 2channels  
2.4 inch TFT LCD  
1ch input : Measurement results of Ach input  
2ch input : Either measurement results of Ach input, measurement results of Bch input, or calculation results  
Measurement results of Ach and Bch input  
Measurement results and calculation results of Ach or Bch input

Display range

-99999 to 99999

Zero display

Leading zero suppression

Decimal point

Arbitrary setting possible

Over range warning

OVER or -OVER when input range or display range is exceeded

Operating temp & humidity range

-5 to 50 °C, 35 to 85% RH (No condensation)

Storage temp & humidity range

-10 to 70 °C, 60% RH or less

Power supply

100 to 240VAC ±10% 50/60 Hz

Power consumption

12VDC ±10%

24 to 48 VDC ±10%

11VA max. (100VAC), 15VA max. (240VAC),

6.5W (12VDC), 6.5W (24VDC), 7W (48VDC)

Dimensions

96mm(W) x 48mm(H) x 145mm(D), 1/8 DIN size

Weight

Approx. 350g

Withstand voltage

AC power supply :

3000VAC for 1 minute: Between the power supply terminal - input / external control / comparator output / option output

DC power supply :

1500VAC for 1 minute: Between the power supply terminal - input / external control / comparator output / option output

AC/DC power supply :

1500VAC for 1 minute: Between the input terminal - external control / comparator output / option output

Between Case - each terminals : 3000VAC for 1 minute

100MΩ (500VDC) or more between the above terminals

Insulation resistance

IP66 (Front bezel)

Protection

2000m or less

Rated altitude

II

Measurement category

2

Contamination level

EN61326-1 (EMS : Industrial installations; EMI : Class A)

Applicable EN standard

\*Applies to wire length of 30m or less

EN61010-1

EN50581

Case material / color

Polycarbonate, Black UL94V-0

## External control

\*Execute by COM terminal short circuit

<b>Compare reset</b>	Turns OFF comparator output monitor and comparator output
<b>Display hold</b>	Holds the display value
<b>Peak hold</b>	Holds the max. value
<b>Bottom hold</b>	Holds the min. value
<b>Amplitude Hold</b>	Holds the difference between max. and min. value
<b>Deviation hold</b>	Holds the display value that has the max. absolute value of difference from reference value
<b>Average hold</b>	Stabilize display by additional moving average for the set number of times
<b>Hold reset</b>	Reset hold state of display value
<b>Digital zero</b>	Set the display value to zero value
<b>Display change</b>	Changes the measurement display
<b>Trend log</b>	Acquire alarm log
<b>Pattern select</b>	Changes the setting patterns (Max. 8 pattern)

\*Each function can be assigned to control terminal 1 to 5.

## Option Specifications

### Comparator output

<b>Output method</b>	Open collector output or Relay output
● <b>Open collector output</b>	Rated output NPN : Sinc current Max. 50mA PNP : Source current Max. 50mA Applied voltage Max. 30V Output saturation voltage 1.2V or less at 50mA
● <b>Relay output</b>	Contact rating : 250VAC 2A, 30VDC 2A Mechanical life : 20,000,000 times Electrical life : 100,000 times
<b>Control method</b>	Microcomputer operation method
<b>Setting range</b>	-99999 to 99999
<b>Hysteresis</b>	1 to 99999 digit for each setpoints
<b>Comparison condition</b>	Condition can be set to AL1 to AL4 independently
● <b>Level judgement mode</b>	The alarm is ON when display value exceeds setpoint (Over alarm) The alarm is ON when display value is under setpoint (Under alarm)

### Over alarm (Upper limit judgement)

Comparison condition	Result
Display value > AL1 judgement value	AL1
Display value > AL2 judgement value	AL2
Display value > AL3 judgement value	AL3
Display value > AL4 judgement value	AL4

### Under alarm (Lower limit judgement)

Comparison condition	Result
AL1 judgement value > Display value	AL1
AL2 judgement value > Display value	AL2
AL3 judgement value > Display value	AL3
AL4 judgement value > Display value	AL4

- **Zone judgement mode** The alarm is ON when between upper and lower judgement values (Inside zone)  
The alarm is ON when out of upper and lower judgement values (Outside zone)

### Inside zone alarm

Comparison condition	Result
AL1 zone HI $\geq$ Display value $\geq$ AL1 zone LO	AL1
AL1 zone HI $\geq$ Display value $\geq$ AL2 zone LO	AL2
AL1 zone HI $\geq$ Display value $\geq$ AL3 zone LO	AL3
AL1 zone HI $\geq$ Display value $\geq$ AL4 zone LO	AL4

### Outside zone alarm

Comparison condition	Result
Display value > AL1 zone HI or AL1 zone LO > Display value	AL1
Display value > AL2 zone HI or AL2 zone LO > Display value	AL2
Display value > AL3 zone HI or AL3 zone LO > Display value	AL3
Display value > AL4 zone HI or AL4 zone LO > Display value	AL4

- **Difference judgement mode** \*Alarm is ON when the (Max.-Min.) during the fixed time exceeds the change judgement value.

Comparison condition	Result
(Max.-Min.) during the fixed time $\geq$ AL1 judgement value	AL1
(Max.-Min.) during the fixed time $\geq$ AL2 judgement value	AL2
(Max.-Min.) during the fixed time $\geq$ AL3 judgement value	AL3
(Max.-Min.) during the fixed time $\geq$ AL4 judgement value	AL4

## Analog output

\*Select either Ach, Bch or calculation results to be output.

<b>Conversion method</b>	D/A conversion method
<b>Resolution capability</b>	Equivalent of 13bit
<b>Scaling</b>	Digital scaling
<b>Response speed</b>	Up to 300 $\mu$ s (0 $\rightarrow$ 90% response)
<b>Specifications for each output</b>	Refer to the following chart.

Output type	Load resistance	Accuracy	Ripple
0~10V	$\geq 2k\Omega$	$\pm 0.1\%$ FS	$\pm 50mV_{P-P}$
-10~10V			
1~5V			
0~20mA	$\leq 500\Omega$		$\pm 25mV_{P-P}$
4~20mA			

\*Ripple for current output is at load resistance 250 $\Omega$  (20mA output)

## BCD Output

\*Select either Ach, Bch or calculation results to be output.

<b>Output type</b>	Open collector output, NPN/PNP type
<b>Measurement data</b>	Negative logic. Transistor ON when logic is "1"
<b>Polarity signal</b>	Negative logic. Transistor ON when negative display
<b>Over signal</b>	Negative logic. Transistor ON when over display
<b>Print command signal</b>	Transistor ON for fixed period when data conversion
<b>Transistor capacity</b>	Voltage 30V max., Current 10mA max. Output saturation voltage $\leq 1.2V$ at 10mA
<b>Enable</b>	Output transistor turns OFF when the enable terminal is short with D.COM

## RS-232C communication

<b>Communication protocol</b>	Modbus RTU*, Original command, Original output
<b>Synchronous system</b>	Asynchronous mode
<b>Communication method</b>	Full duplex
<b>Communication speed</b>	9600bps, 19200bps, 38400bps
<b>Data length</b>	7bit, 8bit
<b>Stop bit</b>	1bit, 2bit
<b>Parity bit</b>	None, Odd, Even
<b>Delimiter</b>	CR, CR+LF
<b>Character code</b>	ASCII
<b>Transmission control procedure</b>	Non-procedure
<b>Signal name</b>	TXD, RXD, SGI
<b>No. of connectable units</b>	1 unit
<b>Line length</b>	15m

\*No data length / stop bit / delimiter settings when Modbus RTU protocol

## RS-485 communication

<b>Communication protocol</b>	Modbus RTU
<b>Synchronous system</b>	Asynchronous mode
<b>Communication method</b>	2-wire half duplex
<b>Communication speed</b>	9600bps, 19200bps, 38400bps
<b>Data length</b>	8bit
<b>Stop bit</b>	1bit, 2bit
<b>Parity bit</b>	N/A, odd number, even number
<b>Signal name</b>	Non-inverting (+), inverting (-)
<b>No. of connectable units</b>	31 units
<b>Line length</b>	1.2km max (Total)

## Terminal Connections

### Lower terminal

(External control / comparator output / power supply)

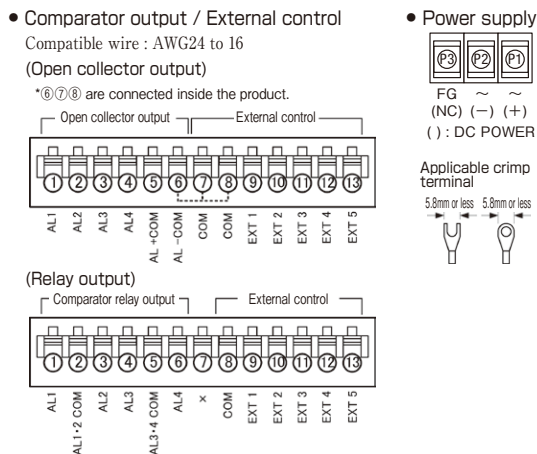

### Upper terminal

(Input / GO output / sensor power supply)

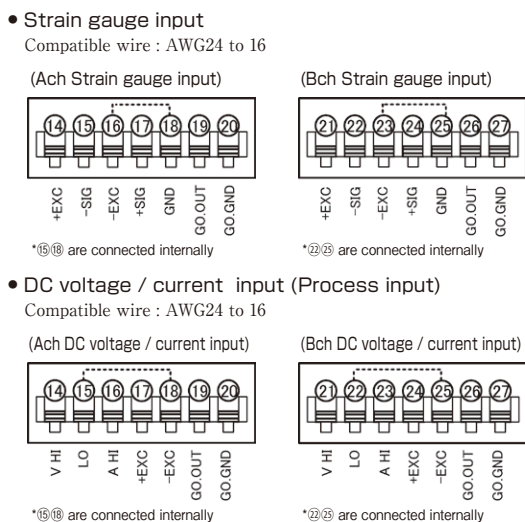

### Middle terminal (Option output)

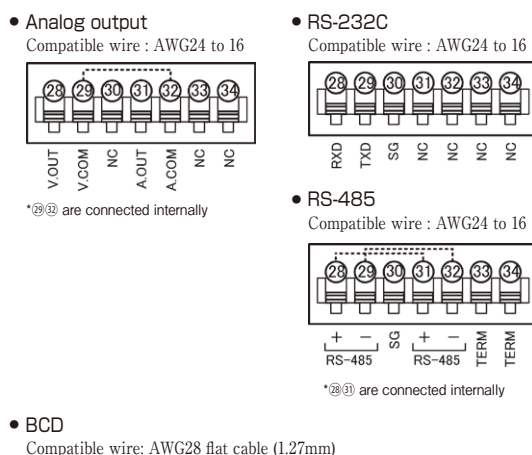

## Dimensions

(1/8 DIN size)

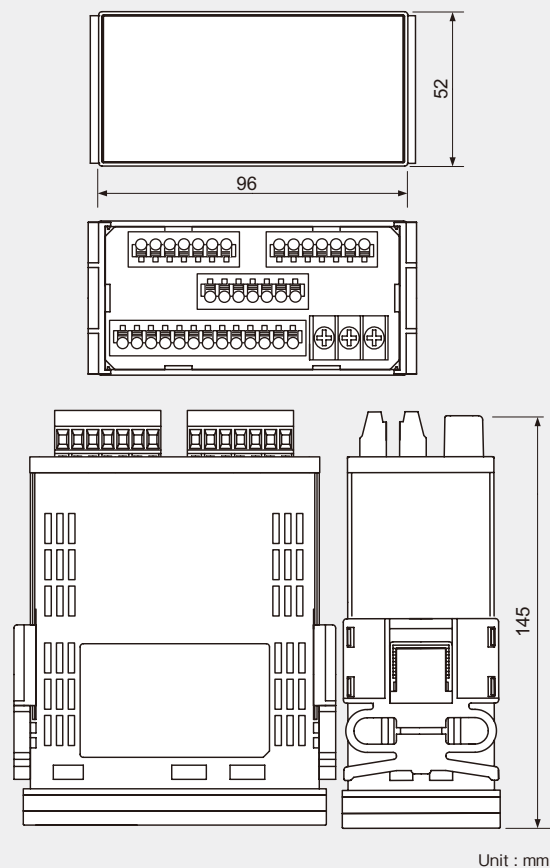

## Panel cutout

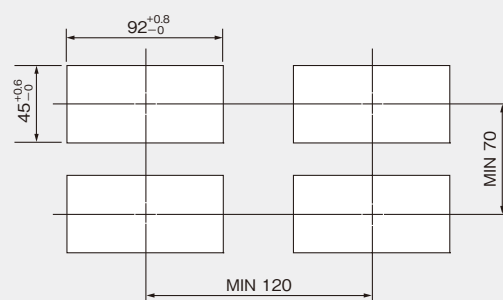

\* Recommended panel thickness : 0.8 to 5.0mm

# Rotation and Speed Measurement

# WPMZ-5

- Rotation and Speed Measurement
- Pulse input
- Line driver input

[WPMZ-5] is Digital panel meter for measuring Rotation & Speed.

By installing a rotary encoder in a line or device that uses a rotating mechanism such as a roll, the speed of the roll can be measured in real time and the rotation can be controlled.



## Application examples



## Main Specifications

### Power supply

- 100~240VAC ±10%
- 12VDC ±10%
- 24~48VDC ±10%

### Input : Ach/Bch

- Pulse input
- Line driver input

### Option output

- Analog output
- BCD output  
(Open collector NPN / PNP)
- RS-232C
- RS-485 (Modbus RTU)

### Comparator output (AL1~AL4)

- Open collector output  
(NPN / PNP)



## Features

- High precision measurement and various measurement menu with 32 bit microcomputer
- Easy to read by 2.4 inch TFT Full color LCD display
- [Value], [Bar graph] and [Trend graph] Display can be selected according to the measurement
- Display rotation function which can select the mounting direction
- Standard 1ch input type, and also 2ch input type which can use for special measurement

## Model

WPMZ-5 — ① ② ③ — ④ ⑤ — ⑥ ⑦

Series	① Power supply	② Input Ach	③ Input Bch	④ Option output	⑤ Comparator output	⑥ Test report	⑦ Suffix code	Description
WPMZ-5								Rotation and Speed Measurement
	1							Power supply voltage: 100 to 240VAC
								Power supply voltage: 12VDC
								Power supply voltage: 24 to 48VDC
		P						Pulse input
		L						Line driver input
			X					None
			P					Pulse input (Note 1)
			L					Line driver input (Note 1)
				X				Display only (External control)
				1				Analog output
				2				BCD output (Open collector NPN)
				3				BCD output (Open collector PNP)
				4				RS-232C Output
				5				RS-485 Output (Modbus RTU)
					E			Open collector output (NPN) (AL1~AL4)
					F			Open collector output (PNP) (AL1~AL4)
						X		Without test report
						T		With test report
							00	Japanese default setting
							E0	English default setting

\*In case of two input type, the combination of pulse input and line driver input cannot be selected together.

## Input Specifications

### Ach input (1ch) / Bch input (2ch)

#### Pulse input

Measurement types	Rotation and speed measurement
Input frequency range	10mHz to 500kHz * 250kHz for 2 channel input
Input signal	Open collector (NPN/PNP), voltage pulse, totem pole output, AC pulse, proximity sensor
Input level	Open collector Pull up to 12V or 24V Logic L level: 1.0V or less H level: 3.9 to 30V (Max. allowable voltage ± 50V)
Input pulse width	Zero-crossing 60mV to 40VAC (Max. Allowable voltage 70V) 0.9µs or more (Both L level and H level) *1.8µs or more in case of 2 channel input
Measurement method	Cyclic calculation method
Accuracy	± (20ppm reading + 1digit) at 23 ± 5°C

#### Line driver input

Measurement types	Rotation and speed measurement
Input frequency range	10mHz to 500kHz * 250kHz for 2 channel input
Input signal	Differential input, input resistance (Termination resistor) : 330Ω *Can be connected one-to-one with RS-422 compliant line driver device
Input level	Line driver signal ±1V or more (Differential voltage)
Input pulse width	0.9µs or more (Both L level and H level) *1.8µs or more in case of 2 channel input
Accuracy	± (20ppm reading + 1digit) at 23 ± 5°C

## Common Specifications

Measurement channel	1 channel or 2 channels (Based on model selection)
Display	2.4 inch TFT LCD 1ch input: Measurement results of Ach input 2 ch input: Either measurement results of Ach input, measurement results of Bch input, or calculation results Measurement results of Ach and Bch input Measurement results and calculation results of Ach or Bch input
Display range	0 to 999999
Zero display	Leading zero suppression
Decimal point	Arbitrary setting possible
Over range warning	OVER or -Over when input range and display range are exceeded
Operating temp & humidity range	-5 to 50°C, 35 to 85% RH (No condensation)
Storage temp & humidity range	-10 to 70°C, 60% RH or less
Power supply	100 to 240VAC ± 10% 50/60 Hz 12VDC ± 10% 24 to 48VDC ± 10%
Power consumption	10VA max. at 100VAC 14VA max. at 240VAC 6W max. at 12VDC 6W max. at 24VDC 6.5W max. at 48VDC
Sensor power supply	12VDC ± 10% 100mA max; 24VDC ± 10% 50mA max *When 2 channel input, allowable current of Ach and Bch together will be above current. *1.2W max. when the combination of 12VDC and 24VDC (For example: Ach is 12V and Bch is 24V) (Line driver input) 5VDC ± 10% 200mA max. *When 2 channel input, allowable current of Ach and Bch together will be above current.
Dimensions	96mm(W) x 48mm(H) x 145mm(D), 1/8 DIN size
Weight	Approx. 350g
Withstand voltage	AC power supply 3000VAC for 1 minute: Between the power supply terminal - input / external control / comparator output / option output DC power supply 1500VAC for 1 minute: Between the power supply terminal - input / external control / comparator output / option output AC/DC power supply 1500VAC for 1 minute: Between the input terminal - external control / comparator output / option output
Insulation resistance	500VDC 100MΩ or more between the above terminals

Protection	IP66 (Front bezel)
Rated altitude	2000m or less
Measurement category	II
Contamination level	2
Applicable EN standard	EN61326-1 (EMS: Industrial installations; EMI: Class A) "Applies to wire length of 30m or less" EN61010-1 EN50581
Case material / color	Polycarbonate, Black UL94V-0

## External control

Comparator reset	Shorted with COM terminal, turns OFF comparator output monitor and comparator output
Measurement prohibited	Shorted with COM terminal, prohibits measurement and integration Measurement prohibited A: Valid for Ach; Measurement prohibited B: Valid for Bch Measurement prohibited A & B: Valid for Ach and Bch simultaneously
Current value hold	Shorted with COM terminal, holds the display value Current value hold A: Valid for Ach; Current value hold B: Valid for Bch Current value hold A & B: Valid for Ach and Bch simultaneously
Max value hold	Shorted with COM terminal, holds the max value Max value hold A: Valid for Ach; Max value hold B: Valid for Bch Max value hold A & B: Effective for Ach and Bch simultaneously
Min value hold	Shorted with COM terminal, holds the min value Min value hold A: Valid for Ach; Min value hold B: Valid for Bch Min value hold A & B: Effective for Ach and Bch simultaneously
Display change	Shorted with COM terminal, changes the measurement display
Pattern change 1 to 3	Shorted with COM terminal, changes the pattern used for measurement
Trend hold	Shorted with COM terminal, holds the trend display
Integrated value reset	Shorted with COM terminal, reset the integrated value

## Option Specifications

### Comparator Output

Open collector output	Rated output NPN : Sinc current Max. 50mA PNP : Source current Max. 50mA Applied voltage Max. 30V Output saturation voltage 1.2V or less at 50mA
Control method	Microcomputer operation method
Setting range	-99999 to 99999
Hysteresis	1 to 99999 digit for each setpoints
Comparison condition	Condition can be set to AL1 to AL4 independently

#### Over alarm (Upper limit judgement)

Comparison condition	Result
Display value > AL1 judgement value	AL1
Display value > AL2 judgement value	AL2
Display value > AL3 judgement value	AL3
Display value > AL4 judgement value	AL4

#### Under alarm (Lower limit judgement)

Comparison condition	Result
AL1 judgement value > Display value	AL1
AL2 judgement value > Display value	AL2
AL3 judgement value > Display value	AL3
AL4 judgement value > Display value	AL4

### Analog output

\*Select either Ach, Bch or calculation results to be output.

Conversion method	D/A conversion method
Resolution	13bit equivalent
Scaling	Digital scaling
Response speed	25ms or less (0 → 90% response)
Specifications by types	See below

Output type	Load resistance	Accuracy (23±5°C 35 to 85%RH)	Ripple
0~10V ±10V	2kΩ or more	±0.1%fs	±50mVp-p
1~5V	550Ω or less		±25mVp-p
0~20mA 4~20mA			

\*Ripple for current output is at load resistance 250Ω(20mA Output)

### BCD Output

\*Select either Ach, Bch or calculation results to be output.

Output type	Open collector output, NPN/PNP type
Measurement data	Negative logic. Transistor ON when logic is "1"
Polarity signal	Negative logic. Transistor ON when negative display
Over signal	Negative logic. Transistor ON when over display
Print command signal	Transistor ON for fixed period when data conversion
Transistor capacity	Voltage 30V max., Current 10mA max. Output saturation voltage ≤1.2V at 10mA
Enable	Output transistor turns OFF when the enable terminal is short with D.COM

### RS-232C communication

Communication protocol	Modbus RTU*, Original command, Original output
Synchronous system	Asynchronous mode
Communication method	Full duplex
Communication speed	9600bps, 19200bps, 38400bps
Data length	7bit, 8bit
Stop bit	1bit, 2bit
Parity bit	None, Odd, Even
Delimiter	CR, CR+LF
Character code	ASCII
Transmission control procedure	Non-procedure
Signal name	TXD, RXD, SGI
No. of connectable units	1 unit
Line length	15m

\*No data length / stop bit / delimiter settings when Modbus RTU protocol

### RS-485 communication

Communication protocol	Modbus RTU
Synchronous system	Asynchronous mode
Communication method	2-wire half duplex
Communication speed	9600bps, 19200bps, 38400bps
Data length	8bit
Stop bit	1bit, 2bit
Parity bit	N/A, odd number, even number
Signal name	Non-inverting (+), inverting (-)
No. of connectable units	31 units
Line length	1.2km max (Total)

## Terminal Connections

### Lower terminal

(External control / comparator output / power supply)

- Comparator output / External control
- Power supply

Compatible wire : AWG24 to 16

\*⑥⑦⑧ are connected inside the product.

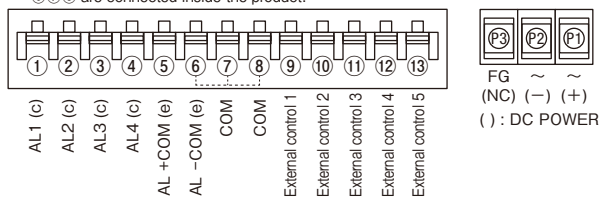

### Upper terminal (Input)

- Input (Ach, Bch)

Compatible wire: AWG24 to 16

Ach pulse input

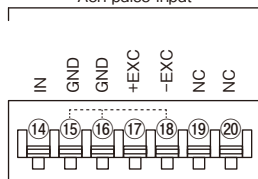

Ach line driver input

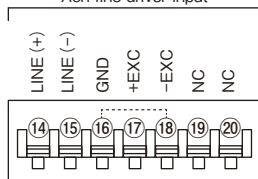

Bch pulse input

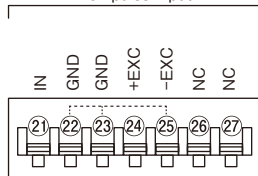

Bch line driver input

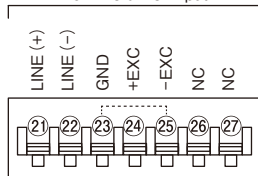

### Middle terminal (Option output)

- Analog output
- RS-232C

Compatible wire : AWG24 to 16

Compatible wire : AWG24 to 16

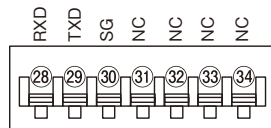
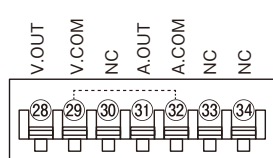

\*Select either Ach, Bch or calculation results to be output.

- RS-485

Compatible wire : AWG24 to 16

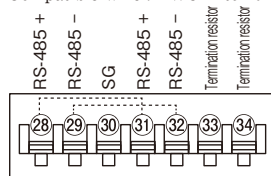

- BCD

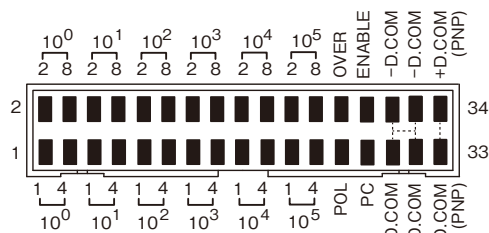

Compatible wire: AWG28 flat cable (1.27mm)

\*Select either Ach, Bch or calculation results to be output.

## Dimensions

(1/8 DIN size)

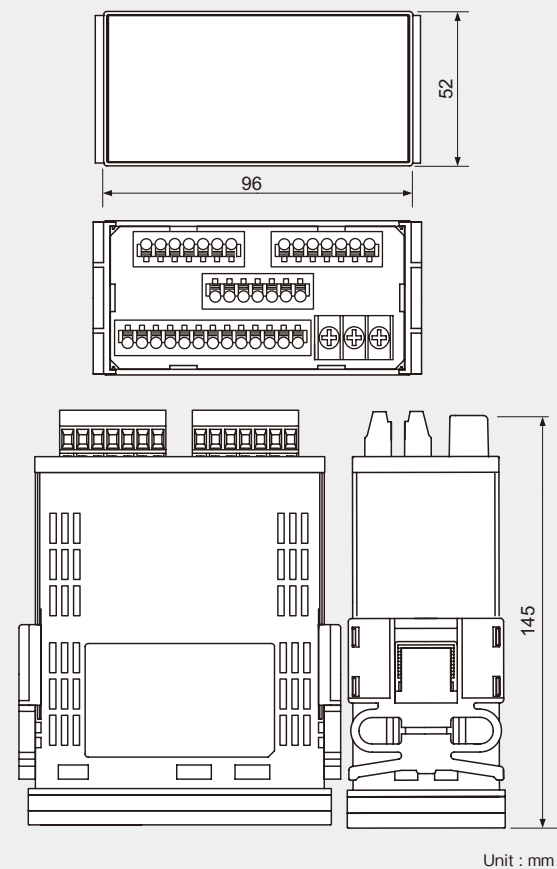

Unit : mm

## Panel cutout

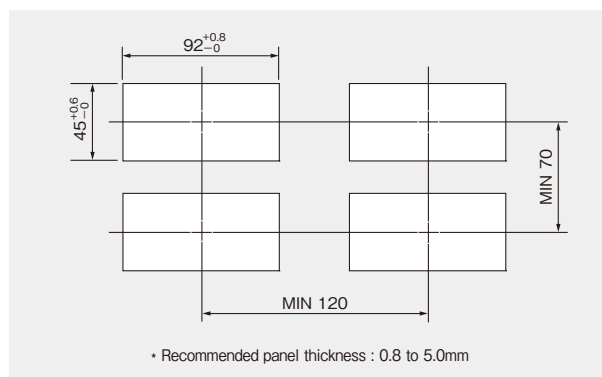

\* Recommended panel thickness : 0.8 to 5.0mm

Instantaneous and integrated flow rate

# WPMZ-6

- Flow rate / Flow total measurement
- Pulse input
- Analog input

[WPMZ-6] is Digital panel meter for measuring Instantaneous / Integrated Flow rate.

It is useful for flow rate / flow total measurement of tanks installed in equipment or production lines etc.

WPMZ-6 can measure two different liquids flow rates, to monitor the flow difference to stabilize the mixing process.



## Application examples

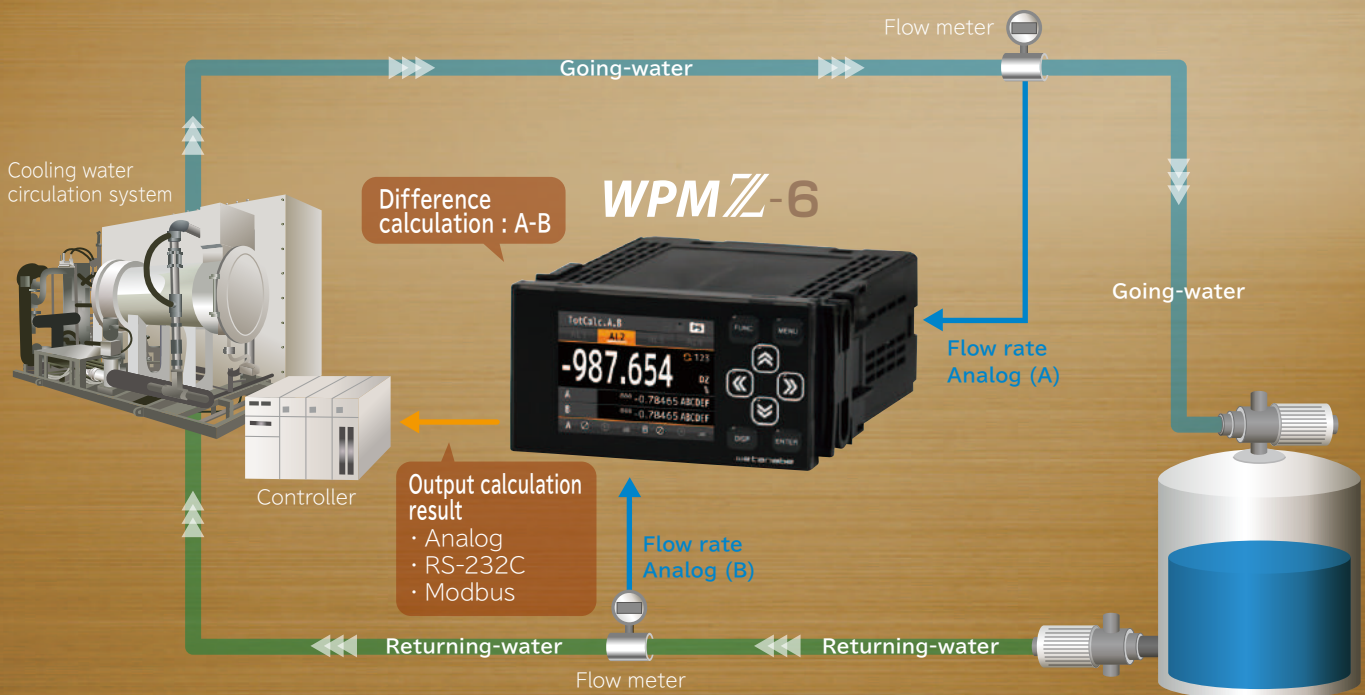

Flow rate / total measurement

3 factors display

Calculation function

## Main Specifications

### Power supply

- 100~240VAC ±10%
- 12VDC ±10%
- 24~48VDC ±10%

### Input : Ach/Bch

- Pulse input
- Analog input input

### Option output

- Analog output
- BCD output (Open collector NPN / PNP)
- RS-232C
- RS-485 (Modbus RTU)

### Comparator output (AL1~AL4)

- Open collector output (NPN / PNP)





## Features

- High precision measurement and various measurement menu with 32 bit microcomputer
- Easy to read by 2.4 inch TFT Full color LCD display
- [Value], [Bar graph] and [Trend graph] Display can be selected according to the measurement
- Display rotation function which can select the mounting direction
- Standard 1ch input type, and also 2ch input type which can use for special measurement

## Model

WPMZ-6 — ① ② ③ — ④ ⑤ — ⑥ ⑦

Series	① Power supply	② Input Ach	③ Input Bch	④ Option output	⑤ Comparator output	⑥ Test report	⑦ Suffix code	Description
WPMZ-6								Instantaneous and integrated flow rate
	1							Power supply voltage: 100 to 240VAC
	3							Power supply voltage: 12VDC
	4							Power supply voltage: 24 to 48VDC
		P						Pulse input
		A						Analog input
			X					None
			P					Pulse input (Note 1)
			A					Analog input (Note 1)
				X				Display only (External control)
				1				Analog output
				2				BCD output (Open collector NPN)
				3				BCD output (Open collector PNP)
				4				RS-232C Output
				5				RS-485 Output (Modbus RTU)
					E			Open collector output (NPN) (ALI/AL4)
					F			Open collector output (PNP) (ALI/AL4)
						X		Without test report
						T		With test report
							00	Japanese default setting
							E0	English default setting

\*In case of two input type, the combination of pulse input and line driver input cannot be selected together.

## Input Specifications

Ach input (1ch) / Bch input (2ch)

Pulse input (Instantaneous / Integration)

Measurement types	Instantaneous integrated measurement
Input frequency range	10mHz to 500kHz * 250kHz for 2 channel input
Input signal	Open collector (NPN/PNP), voltage pulse, totem pole output, AC pulse, proximity sensor *In the case of two pulse input, a 2-phase (90° phase) pulse input is available
Input level	Open collector Pull up to 12V or 24V Logic L level: 1.0V or less H level: 3.9 to 30V (Max. allowable voltage ±50V) Zero-crossing 60mV to 40VAC (Max. Allowable voltage 70V)
Input pulse width	0.9μs or more (Both L level and H level) *1.8μs or more in case of 2 channel input Cyclic calculation method
Measurement method (Instantaneous display) Accuracy	±(20ppm reading + 1digit) at 23 ± 5° C
(Integrated display) Accuracy	± 0 (When scaling is "1")
Integrated value reset	Clears integrated value by external control
Pulse output	NPN open collector pulse output 30VDC 20mA max

Analog input (Instantaneous integration)

Measurement range	Input impedance	Maximum allowable input	Accuracy
1~5V	About 1MΩ	±100V	±(0.05% of FS + 1digit)
0~5V			
0~10V			
4~20mA	About 10MΩ	±50mA	
0~20mA			

Conversion method	ΔΣ conversion method
Input circuit	Single-ended type
Sampling rate	100 times/second max

## Common Specifications

Measurement channel	1 channel or 2 channels (Based on model selection)
Display	2.4 inch TFT LCD 1ch input: Measurement results of Ach input 2ch input: Either measurement results of Ach input, measurement results of Bch input, or calculation results Measurement results of Ach and Bch input Measurement results and calculation results of Ach or Bch input
Display range	0 to 999999
Zero display	Leading zero suppression
Decimal point	Arbitrary setting possible
Over range warning	OVER or -Over when input range and display range are exceeded
Operating temp & humidity range	-5 to 50°C, 35 to 85% RH (No condensation)
Storage temp & humidity range	-10 to 70°C, 60% RH or less
Power supply	100 to 240VAC ±10% 50/60 Hz 12VDC ±10% 24 to 48VDC ±10%
Power consumption	10VA max. at 100VAC 14VA max. at 240VAC 6W max. at 12VDC 6W max. at 24VDC 6.5W max. at 48VDC
Sensor power supply	12VDC ±10% 100mA max; 24VDC ±10% 50mA max *When 2 channel input, allowable current of Ach and Bch together will be above current. *1.2W max. when the combination of 12VDC and 24VDC (For example: Ach is 12V and Bch is 24V) (Line driver input) 5VDC ±10% 200mA max. *When 2 channel input, allowable current of Ach and Bch together will be above current.
Dimensions	96mm(W) x 48mm(H) x 145mm(D), 1/8 DIN size
Weight	Approx. 350g

<b>Withstand voltage</b>	AC power supply 3000VAC for 1 minute: Between the power supply terminal - input / external control / comparator output / option output DC power supply 1500VAC for 1 minute: Between the power supply terminal - input / external control / comparator output / option output AC/DC power supply 1500VAC for 1 minute: Between the input terminal - external control / comparator output / option output 500VDC 100M $\Omega$ or more between the above terminals
<b>Insulation resistance Protection</b>	IP66 (Front bezel)
<b>Rated altitude</b>	2000m or less
<b>Measurement category</b>	II
<b>Contamination level</b>	2
<b>Applicable EN standard</b>	EN61326-1 (EMS: Industrial installations; EMI: Class A) "Applies to wire length of 30m or less" EN61010-1 EN50581
<b>Case material / color</b>	Polycarbonate, Black UL94V-0

## External control

<b>Comparator reset</b>	Shorted with COM terminal, turns OFF comparator output monitor and comparator output
<b>Measurement prohibited</b>	Shorted with COM terminal, prohibits measurement and integration Measurement prohibited A: Valid for Ach; Measurement prohibited B: Valid for Bch Measurement prohibited A & B: Valid for Ach and Bch simultaneously
<b>Current value hold</b>	Shorted with COM terminal, holds the display value Current value hold A: Valid for Ach; Current value hold B: Valid for Bch Current value hold A & B: Valid for Ach and Bch simultaneously
<b>Max value hold</b>	Shorted with COM terminal, holds the max value Max value hold A: Valid for Ach; Max value hold B: Valid for Bch Max value hold A & B: Effective for Ach and Bch simultaneously
<b>Min value hold</b>	Shorted with COM terminal, holds the min value Min value hold A: Valid for Ach; Min value hold B: Valid for Bch Min value hold A & B: Effective for Ach and Bch simultaneously
<b>Display change</b>	Shorted with COM terminal, changes the measurement display
<b>Pattern change 1 to 3</b>	Shorted with COM terminal, changes the pattern used for measurement
<b>Trend hold</b>	Shorted with COM terminal, holds the trend display
<b>Integrated value reset</b>	Shorted with COM terminal, reset the integrated value

## Option Specifications

### Comparator Output

<b>Open collector output</b>	Rated output NPN : Sinc current Max. 50mA PNP : Source current Max. 50mA Applied voltage Max. 30V Output saturation voltage 1.2V or less at 50mA
<b>Control method</b>	Microcomputer operation method
<b>Setting range</b>	-99999 to 99999
<b>Hysteresis</b>	1 to 99999 digit for each setpoints
<b>Comparison condition</b>	Condition can be set to AL1 to AL4 independently

#### Over alarm (Upper limit judgement)

Comparison condition	Result
Display value > AL1 judgement value	AL1
Display value > AL2 judgement value	AL2
Display value > AL3 judgement value	AL3
Display value > AL4 judgement value	AL4

#### Under alarm (Lower limit judgement)

Comparison condition	Result
AL1 judgement value > Display value	AL1
AL2 judgement value > Display value	AL2
AL3 judgement value > Display value	AL3
AL4 judgement value > Display value	AL4

### Analog output

\*Select either Ach, Bch or calculation results to be output.

<b>Conversion method</b>	D/A conversion method
<b>Resolution</b>	13bit equivalent
<b>Scaling</b>	Digital scaling
<b>Response speed</b>	25ms or less (0 $\rightarrow$ 90% response)
<b>Specifications by types</b>	See below

Output type	Load resistance	Accuracy (23 $\pm$ 5°C 35 to 85%RH)	Ripple
0~10V	2k $\Omega$ or more	$\pm$ 0.1%fs	$\pm$ 50mV <sub>p-p</sub>
$\pm$ 10V			
1~5V	550 $\Omega$ or less		$\pm$ 25mV <sub>p-p</sub>
0~20mA			
4~20mA			

\*Ripple for current output is at load resistance 250 $\Omega$ (20mA Output)

### BCD Output

\*Select either Ach, Bch or calculation results to be output.

<b>Output type</b>	Open collector output, NPN/PNP type
<b>Measurement data</b>	Negative logic. Transistor ON when logic is "1"
<b>Polarity signal</b>	Negative logic. Transistor ON when negative display
<b>Over signal</b>	Negative logic. Transistor ON when over display
<b>Print command signal</b>	Transistor ON for fixed period when data conversion
<b>Transistor capacity</b>	Voltage 30V max., Current 10mA max. Output saturation voltage $\leq$ 1.2V at 10mA
<b>Enable</b>	Output transistor turns OFF when the enable terminal is short with D.COM

### RS-232C communication

<b>Communication protocol</b>	Modbus RTU*, Original command, Original output
<b>Synchronous system</b>	Asynchronous mode
<b>Communication method</b>	Full duplex
<b>Communication speed</b>	9600bps, 19200bps, 38400bps
<b>Data length</b>	7bit, 8bit
<b>Stop bit</b>	1bit, 2bit
<b>Parity bit</b>	None, Odd, Even
<b>Delimiter</b>	CR, CR+LF
<b>Character code</b>	ASCII
<b>Transmission control procedure</b>	Non-procedure
<b>Signal name</b>	TXD, RXD, SGI
<b>No. of connectable units</b>	1 unit
<b>Line length</b>	15m

\*No data length / stop bit / delimiter settings when Modbus RTU protocol

### RS-485 communication

<b>Communication protocol</b>	Modbus RTU
<b>Synchronous system</b>	Asynchronous mode
<b>Communication method</b>	2-wire half duplex
<b>Communication speed</b>	9600bps, 19200bps, 38400bps
<b>Data length</b>	8bit
<b>Stop bit</b>	1bit, 2bit
<b>Parity bit</b>	N/A, odd number, even number
<b>Signal name</b>	Non-inverting (+), inverting (-)
<b>No. of connectable units</b>	31 units
<b>Line length</b>	1.2km max (Total)

## Terminal Connections

### Lower terminal

(External control / comparator output / power supply)

- Comparator output / External control
- Power supply

Compatible wire : AWG24 to 16

\*⑥⑦⑧ are connected inside the product.

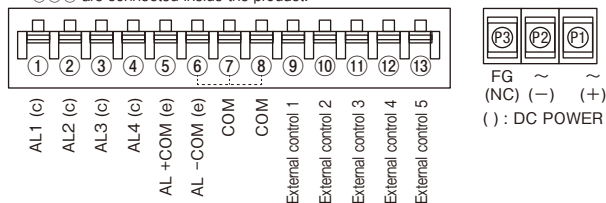

### Upper terminal (Input)

- Input (Ach, Bch)

Compatible wire: AWG24 to 16

Ach pulse input

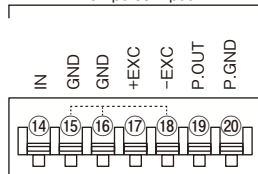

Ach line driver input

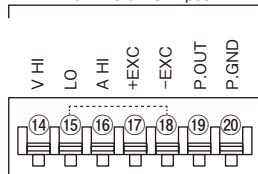

Bch pulse input

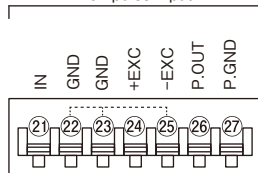

Bch line driver input

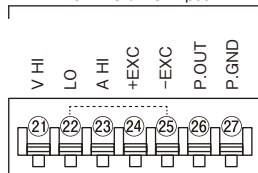

### Middle terminal (Option output)

- Analog output
- RS-232C
- RS-485

Compatible wire : AWG24 to 16

Compatible wire : AWG24 to 16

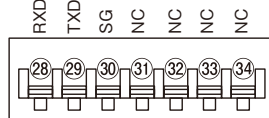
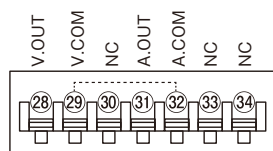

\*Select either Ach, Bch or calculation results to be output.

Compatible wire : AWG24 to 16

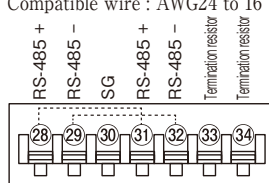

- BCD

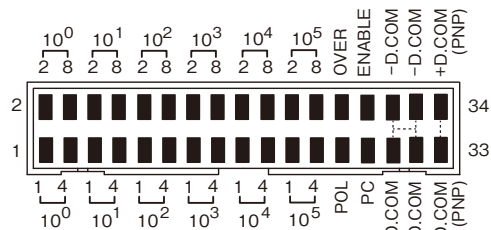

Compatible wire: AWG28 flat cable (1.27mm)

\*Select either Ach, Bch or calculation results to be output.

## Dimensions

(1/8 DIN size)

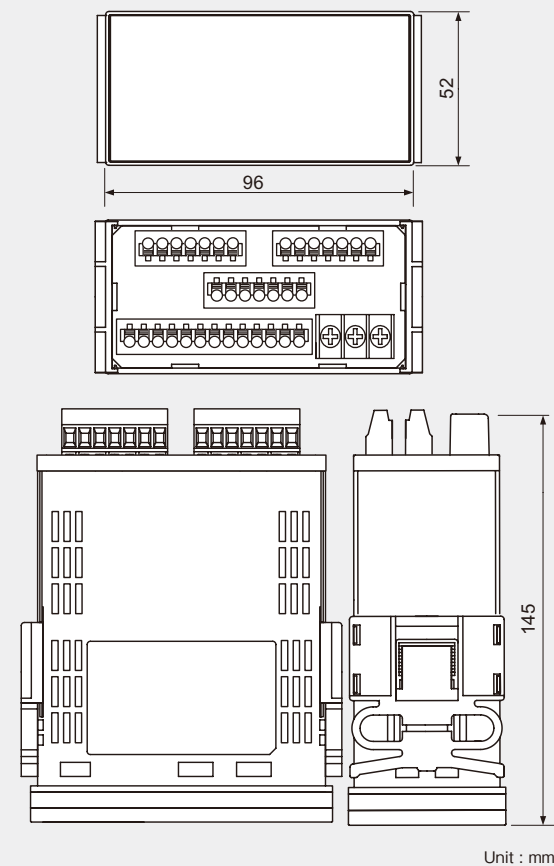

## Panel cutout

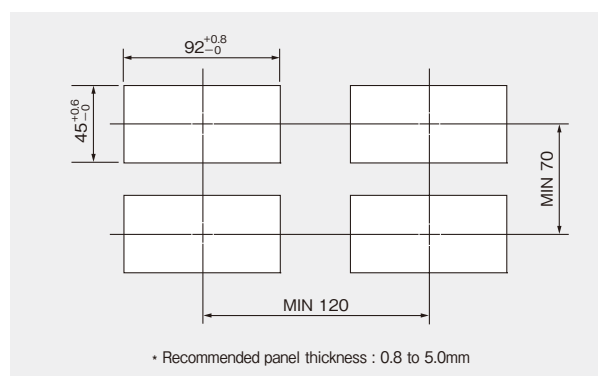



*watanabe*

1st edition, Mar 2019

## Watanabe Electric Industry Co. Ltd.

6-16-19 Jingumae, Shibuya-ku, Tokyo 150-0001, Japan  
TEL +81-3-3400-6147 FAX +81-3-3409-3156

<https://www.watanabe-electric.co.jp/en/>

Mail : [support@watanabe-electric.co.jp](mailto:support@watanabe-electric.co.jp)

1903C10(E)-1