

<b>MODEL :</b>	HTOP-BEVER-1003A	HTOP-BEVER-1068A
	HTOP-BELLA-1066A	



### WARRANTY:

- \* 3-year warranty on Adjustable WDI Fitting
- \* 3-year warranty on Seat Cover

Log on to [www.haustern.com](http://www.haustern.com) for more information on terms and conditions

*This specification is subject to change without notice. FIAMMA TRADING SDN. BHD. will not be held responsible for the use of superseded or voided specifications. Fabricator must check for cut-out accuracy.*

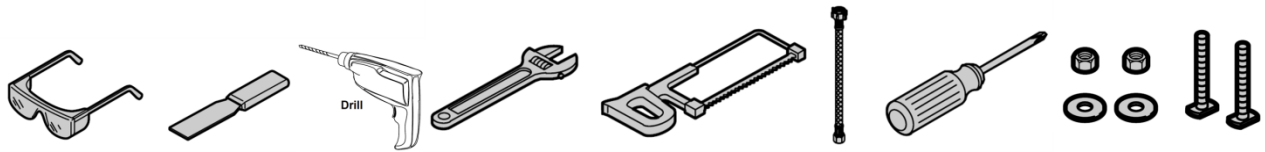

## FOREWOOD

- These instructions are only a guide and all Haustern products must be installed by a qualified contractor.
- Ensure that the correct tools are used in each step of these procedures.
- Ensure water is turned off before the installation, and should have been aside of sewage and water supply pipes.
- Prior to installation remove the toilet from carton and inspect for transport damage.

1. Locate and mark new toilet mount locations on floor. Taking the waste hole as the center point, mark the "x" at left and right of the waste hole and drill a 6mm hole.

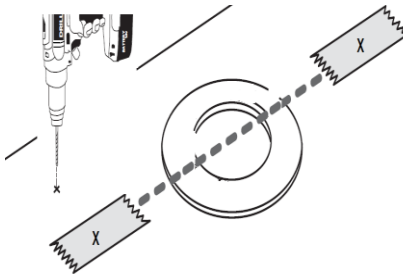

2. Apply weight evenly. Do not move after placement! Watertight seal may be broken!

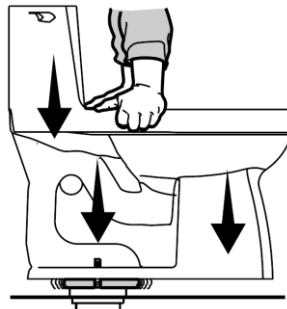

3. Install the washers and nuts as shown. **Do not over tighten!**

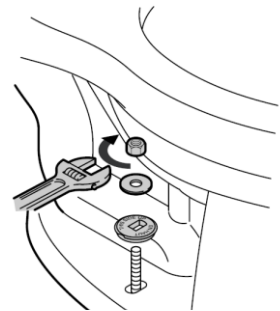

4. If needed, cut off the T-bolts before installing the bolt caps (not provided).

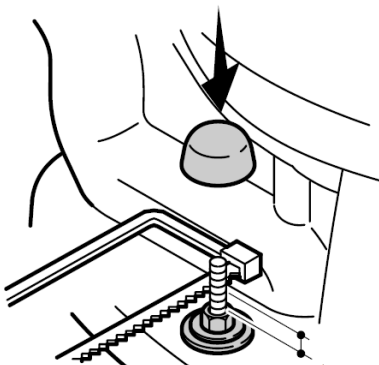

5. Connect the water supply and turn on the valve. Check for leaks. **Do not over tighten!**

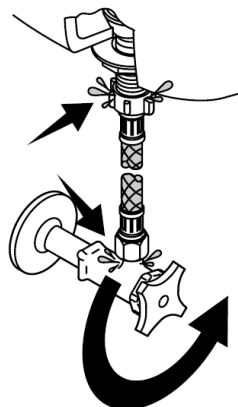



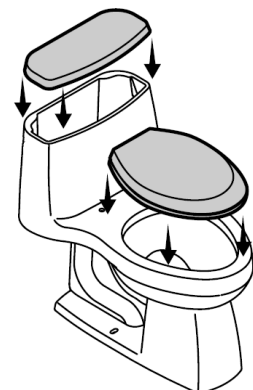



6. Fix the WDI Fitting according to Manufacturer installation manual. If needed, adjust the tank water level. Then install the seat and tank lid.



<b>PRODUCT CATEGORY :</b>	<b>UF SEAT COVER</b>	
<b>MODEL :</b>	HTCC-BEVER-2003	HTCC-BEVER-2036
	HTOP-BEVER-1068	HTOP-BEVER-1003

- These instructions are only a guide and all Haustern products must be installed by a qualified contractor.
- Ensure that the correct tools are used in each step of these procedures.

<p><b>STEP 1:</b> Insert the screw to the hole of the pan.</p> 	<p><b>STEP 2:</b> Loosely install the setscrew in order to adjust the seat cover properly.</p> 	<p><b>STEP 3:</b> Install the stainless steel screw cover on the set screw. Take out the seat cover once the installation position is confirmed.</p> 
<p><b>STEP 4:</b> Fixed the UF Seat Cover on the pan. Adjust the seat cover by accurately aiming the hole of the seat cover to the set screw. Ensure the seat cover and pan match nicely.</p> 	<p><b>STEP 5:</b> Finished.</p> 	<p><b>STEP 6:</b> Should you require removing the seat cover, gently press the left and right button simultaneously and gradually pull upward to remove the seat cover.</p> 

### WARRANTY:

1. 3-year warranty on Seat Cover.

Log on to [www.haustern.com](http://www.haustern.com) for more information on terms and conditions

*This specification is subject to change without notice. FIAMMA TRADING SDN. BHD. will not be held responsible for the use of superseded or voided specifications. Fabricator must check for cut-out accuracy.*