

MODEL :	HTOP-BEVER-1003A	HTOP-BEVER-1068A
	HTOP-BELLA-1066A	



WARRANTY:

- * 3-year warranty on Adjustable WDI Fitting
- * 3-year warranty on Seat Cover

Log on to www.haustern.com for more information on terms and conditions

This specification is subject to change without notice. FIAMMA TRADING SDN. BHD. will not be held responsible for the use of superseded or voided specifications. Fabricator must check for cut-out accuracy.

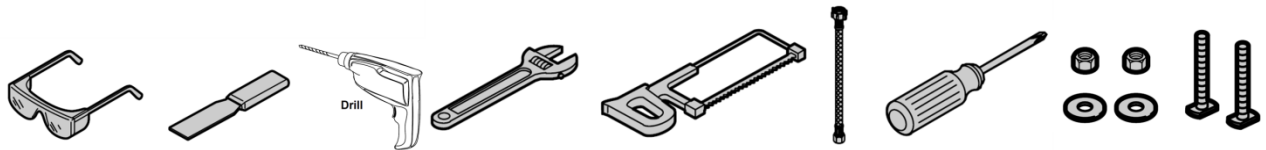

FOREWOOD

- These instructions are only a guide and all Haustern products must be installed by a qualified contractor.
- Ensure that the correct tools are used in each step of these procedures.
- Ensure water is turn off before the installation, and should have been aside of sewage and water supply pipes.
- Prior to installation remove the toilet from carton and inspect for transport damage.

1. Locate and mark new toilet mount locations on floor. Taking the waste hole as the center point, mark the "x" at left and right of the waste hole and drill a 6mm hole.

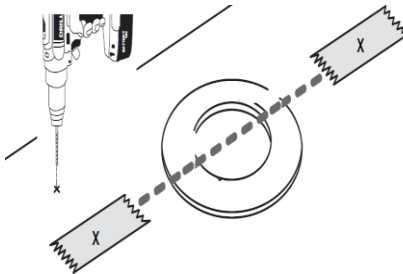

2. Apply weight evenly. Do not move after placement! Watertight seal may be broken!

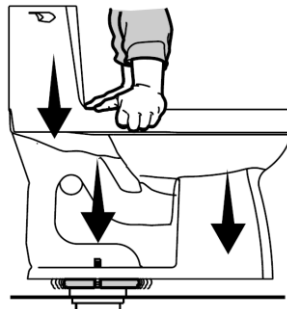

3. Install the washers and nuts as shown. **Do not over tighten!**

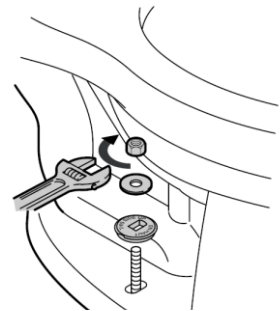

4. If needed, cut off the T-bolts before installing the bolt caps (not provided).

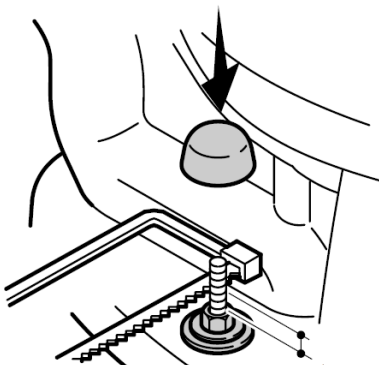

5. Connect the water supply and turn on the valve. Check for leaks. **Do not over tighten!**

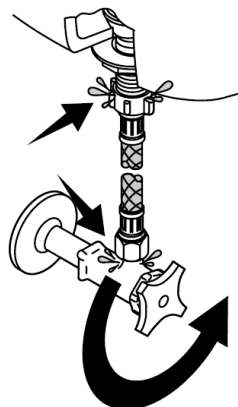



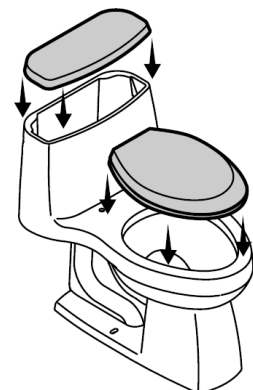

6. Fix the WDI Fitting according to Manufacturer installation manual. If needed, adjust the tank water level. Then Install the seat and tank lid.



Seat Cover Model	HT-FT-1066	HT-FT-2053
Product Model	HTOP-BELLA-1066A	HTCC-WISPER-2053A

- These instructions are only a guide and all Haustern products must be installed by a qualified contractor.
- Ensure that the correct tools are used in each step of these procedures.

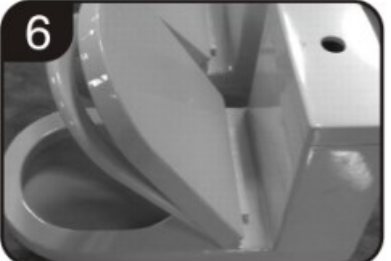
<p>STEP 1: Draw out the platform from the hinge of the seat cover.</p>	<p>STEP 2: Put the platform on top of the toilet seat as per illustrated.</p>	<p>STEP 3: Inset the screw and make sure it is point to point.</p>
		
<p>STEP 4: Fix in the screw loosely from the bottom without tightening it.</p>	<p>STEP 5: Adjust the seat cover to the right position and then tighten the screw.</p>	<p>STEP 6: It is DONE! You may simply test your seat cover.</p>
		

WARRANTY:

- 3-year warranty on Seat Cover.

Log on to www.haustern.com for more information on terms and conditions

This specification is subject to change without notice. FIAMMA TRADING SDN. BHD. will not be held responsible for the use of superseded or voided specifications. Fabricator must check for cut-out accuracy.