

SPIRALAIR

Oil-free Compressors

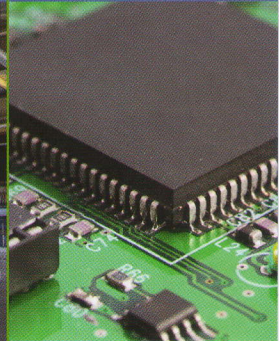

SPR 2-30

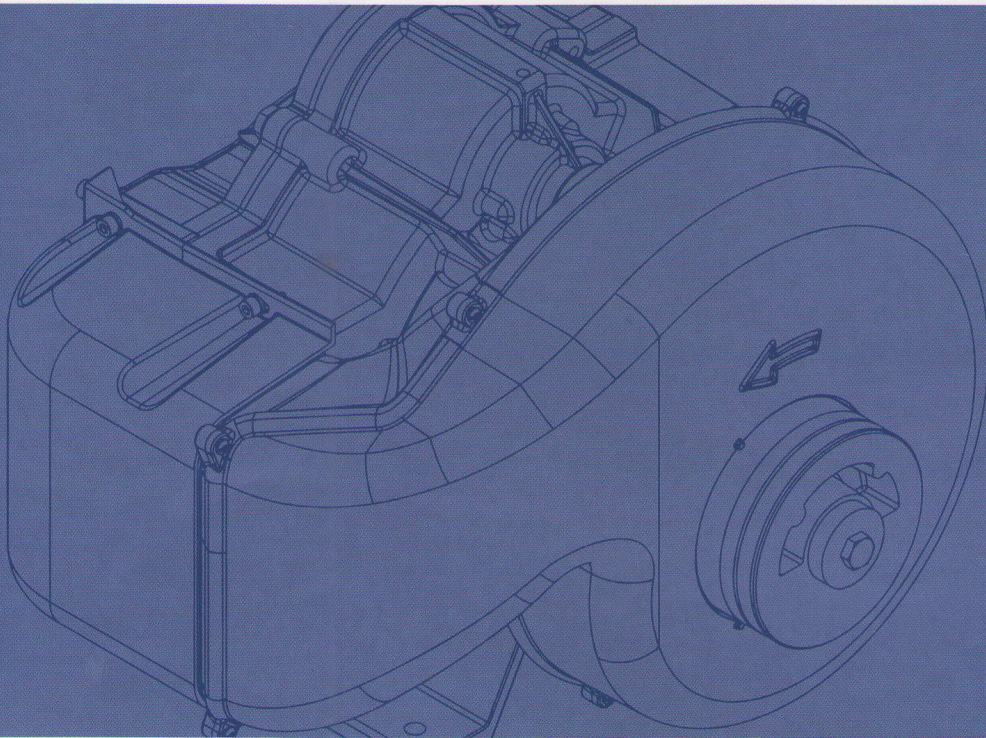

Oil-free compressors

Industries such as pharmaceuticals, food and beverage, electronics and textiles cannot risk any chance of oil contamination in their processes. Therefore, it is essential that the compressed air is 100% oil-free. The standard is ISO 8573-1 (2010) certification, in which Class Zero represents the highest air purity. It is the only way to ensure oil-free air for your critical processes and with it peace of mind.

Outstanding reliability, low maintenance and operating costs make oil-free compressors a sound investment.

www.oilfreecompressors.eu

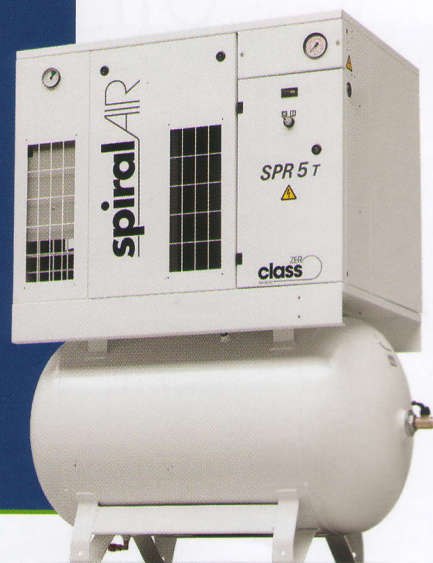

The power of our oil-free scroll range

SPR 2-30 oil-free scroll compressors provide high-quality compressed air for critical applications in a wide range of industries. Continuous investment in research and development has resulted in economical and ecological compressors.

Oil-free quality air

- Ultimate 100% oil-free, clean air.
- No filtration system required to remove residual oil along the network.

Energy efficiency

- No unload power consumption.
- Standard equipped with high-efficiency IE3 motor.

Ultimate reliability and serviceability

- High quality materials, with a minimal number of moving parts ensure a long operating life with minimal service interventions.
- No need for oil change and oil waste management.
- Service friendly vertical layout.

High-efficiency, high-quality air

The SPR 2-30 range provides top class performance, premium efficiency and quality. What's more, with an oil-free compressor, you are also reducing your total cost of ownership in three ways: (1) by avoiding expensive filter replacements, (2) cutting maintenance costs for treating oil condensate and (3) the costs of extra energy needed to combat pressure drop across filters.

Premium performance

- Pressure rating up to 10 bar.
- Output from:
 - 6,8 to 147 m³/h.
 - 1,9 to 40,8 l/s.
 - 4,0 to 86,5 cfm.
- Sound levels as low as 53 dB.

Premium quality

- ISO 8573-1 Class 0* certified quality air.
- Corrosion proof materials.
- Ambient temperature sensor:
 - Standard available on the Spiralair Multi
 - Identification & logging of shutdowns
 - Adjustment of service schedule

Premium efficiency

- Built-in dryer to reduce downstream pressure drop.
- Latest in-house designed compression technology.
- Standard equipped with high-efficiency IE3 motor.



Class 0: eliminating any risk

Class 0 represents the best air quality possible. In critical environments it is essential that the compressed air is 100% oil-free. Contamination by even the smallest quantities of oil can cause costly production downtime and product spoilage, resulting in product recalls and loss of reputation.

CLASS*	Concentration total oil (aerosol, liquid, vapour) mg/m ³
0	As specified by the equipment user or supplier and more stringent than class 1
1	≤ 0,01
2	≤ 0,1
3	≤ 1
4	≤ 5

One package – multiple benefits

Check out the innovative features of the SPR 2-30 range and see how they provide you with maximized efficiency, excellent air quality and low noise levels.

State-of-the-art element

- Highly efficient profile.
- Robust, reliable design and easy access for service.
- Lower vibration levels.

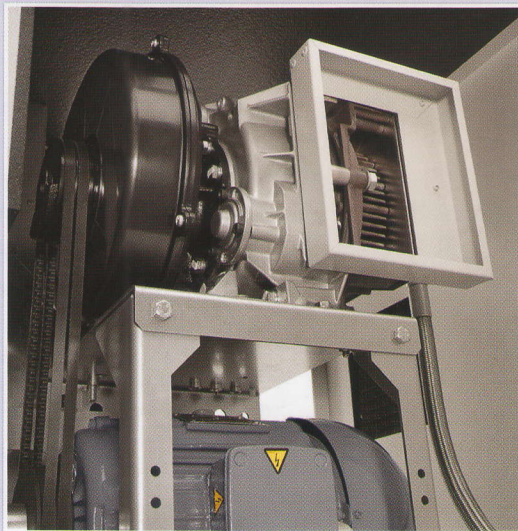

Maximized efficiency

High-efficiency motor

- High-efficiency IE3 / NEMA Premium motors as a standard.
- Totally enclosed air-cooled IP 55 class F motor for heavy duty operation.

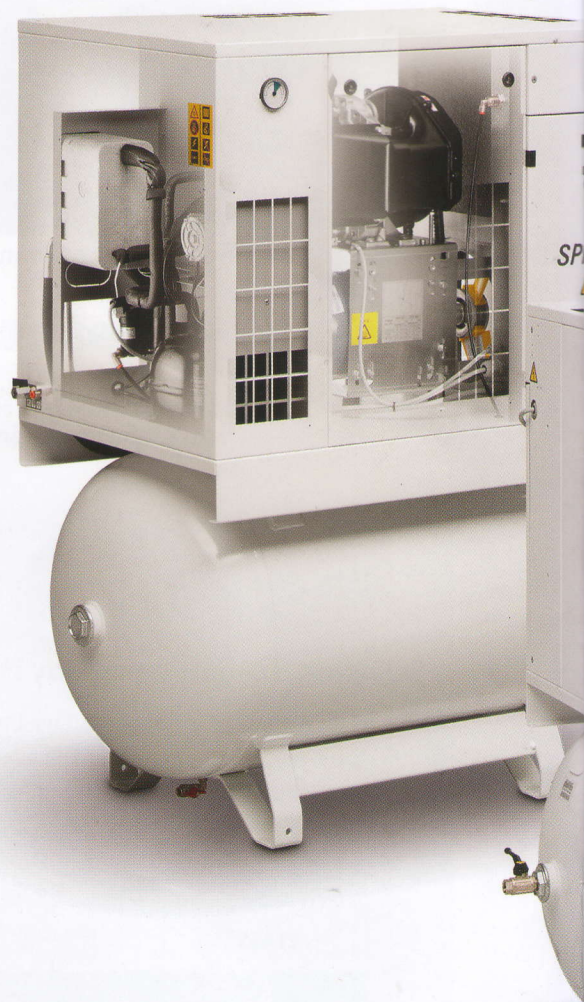

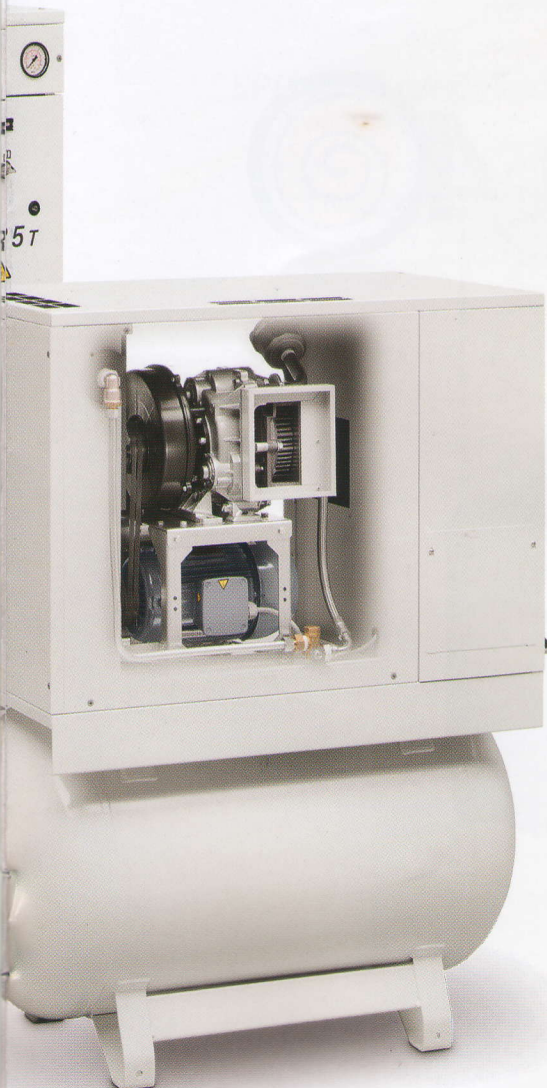

Integrated dryer

- Integrated into the package to reduce footprint, maintenance and installation cost.
- Designed to guarantee a constant pressure dew point of +3°C PDP.
- Ensures the delivery of dry high-quality air.

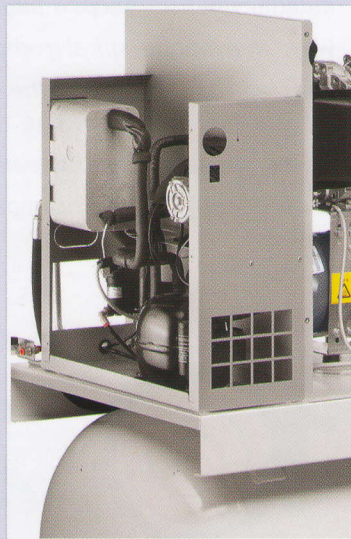

Air quality

Sound insulated canopy

Allows installation in most working environments without requiring a separate compressor room.

Cool canopy

- Increased ventilation due the vertical design.
- Lower element & air outlet temperatures.
- Oversized cooler improving the performance of the unit.
- Improved canopy design: better dryer performance and easy access.

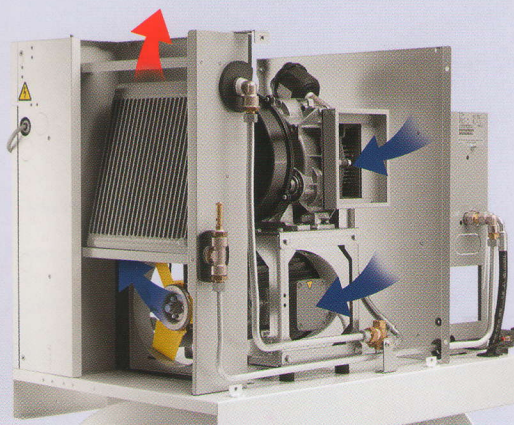

Smart design

Scroll technology: how does it work?

Air compression is achieved through the orbital motion of two spirals. One being static, the second mobile, their interaction pulls the air into the compression chamber. In a regular and continuous way, the mobile spiral compresses the air through a reduction of the volume. The air flow is directed to the center of the spiral after which it is cooled.

As the spirals never make any contact, this compression process does not require any lubrication. Consequently, Spiralair compressors guarantee 100% oil-free compressed air.

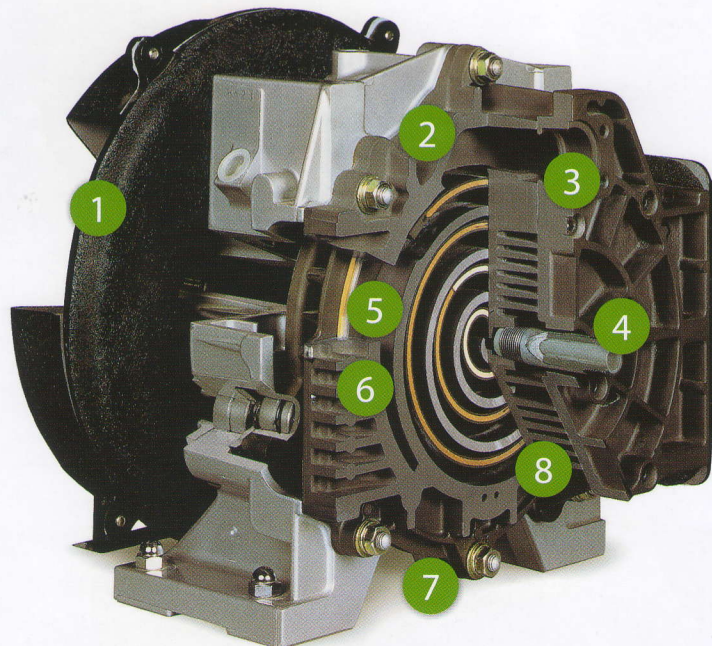

1 Cooling fan

2 Suction chamber

3 Suction opening

4 Delivery opening

5 Fixed scroll

6 Orbiting scroll

7 Fail-safe temperature sensor for unit protection

8 Compression chamber

Variable Air Delivery

The SPR 10-30 units are equipped with multiple scroll modules. The units utilize Variable Air Delivery technology which controls the required number of modules depending on your air demand. Hence, the Spiralair Multi can adjust to demand fluctuations.

The intelligent controller prevents simultaneous start of the modules and ensures a very narrow pressure band is maintained. This optimizes the efficiency of the compressor and guarantees a very stable system pressure.

SPR 20 (4 modules) Variable Air Delivery

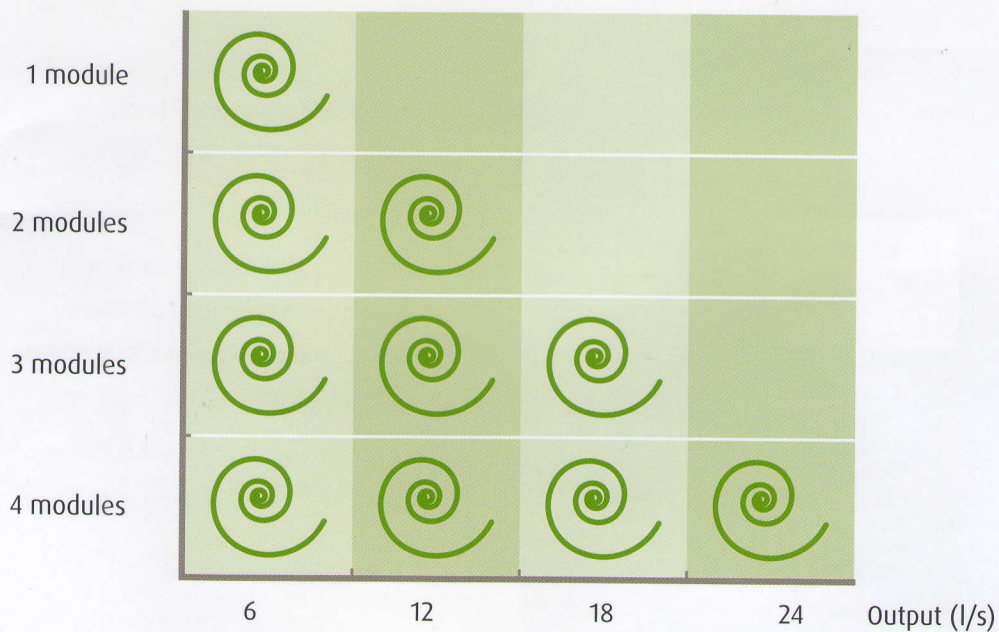



Control & monitoring

The Spiralair range comes with a wide variety of control and monitoring features that allow you to increase your compressor's efficiency and reliability. The SPR 2-8 are equipped with an Electro Pneumatic Control which automatically starts/stops the unit when the required working pressure is reached. The SPR 10-30 come with a Graphic Controller.

Intelligent Graphic Controller (SPR 10-30)

The multiple control and monitoring features of the controller on the SPR 10-30 units dramatically increases the compressor's efficiency and reliability. Efficiency is maximized by controlling the main drive motor and regulating the system pressure within a pre-defined and narrow pressure band.



Control and monitoring features:

- Warning indications.
- Graphical indication service plan.
- Integrated sequence for up to 6 compressors limiting the energy consumption and equalizing running hours across your whole system.
- Online visualization of running conditions.

Service to protect your investment



The original part identification confirms that these components passed our strict test criteria. All parts are designed to match the compressor and are approved for use on the specified compressor. They have been thoroughly tested to obtain the highest level of protection, extending the compressor's lifetime and keeping the cost of ownership to an absolute minimum. No compromises were made on reliability. The use of 'original part' certified quality components helps to ensure reliable operation and will not impact the validity of your warranty, unlike other parts. Look for your quality insurance.

Please contact your local service representative for more information.

Options

A wide range of options enables you to get the most out of your Spiralair compressor.

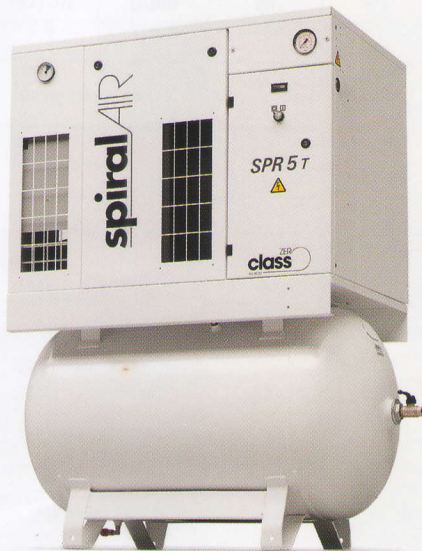

General options (SPR 2-8)

- Tank-mounted solution
 - 30 litre
 - 270 litre
 - 500 litre
- Phase sequence relay

Air quality options (SPR 2-8)

- Integrated refrigerant dryer
- Prefiltration kit
- Water Separator Drain (WSD) (not in combination with an integrated refrigerant dryer)
- Electronic drain on air receiver
 - Standard for 30 litre
 - Optional for 270 & 500 litre



Energy efficiency option (SPR 10-30)

- ES6i integrated multiple compressor control for up to 6 compressors

For further information on how our options can optimize your operations, please contact your local representative.

Technical specifications

	Model	Max. working pressure	Free Air Delivery			Motor power		Noise level	Weight*
		bar	m ³ /h	l/s	cfm	kW	hp	dB(A)	std (kg)
Mono	SPR 2	8	10,4	2,9	6,1	1,5	2	53	120
		10	6,8	1,9	4,0				
	SPR 3	8	15,1	4,2	8,9	2,2	3	55	125
		10	12,2	3,4	7,2				
	SPR 5	8	24,1	6,7	14,2	3,7	5	57	133
		10	21,2	5,9	12,5				
	SPR 8	8	35,3	9,8	20,8	5,5	7,5	59	157
		10	27,4	7,6	16,1				
Multi	SPR 10	8	48,0	13,4	28,4	2 x 3,7	2 x 5	63	372
		10	40,8	11,4	24,2				
	SPR 15	8	73,2	20,3	43,0	2 x 5,5	2 x 7,5	63	418
		10	54,0	15,0	31,8				
	SPR 20	8	95,0	26,4	55,9	4 x 3,7	4 x 5	63	580
		10	82,8	23,0	48,7				
	SPR 22	8	111,6	31,0	65,7	3 x 5,5	3 x 7,5	64	573
		10	85,2	23,7	50,2				
	SPR 30	8	147,0	40,8	86,5	4 x 5,5	4 x 7,5	65	687
		10	108,0	30,0	63,6				

* The weight stated relates to the floormounted units without an integrated dryer.

Machines are available in 50 and 60Hz.

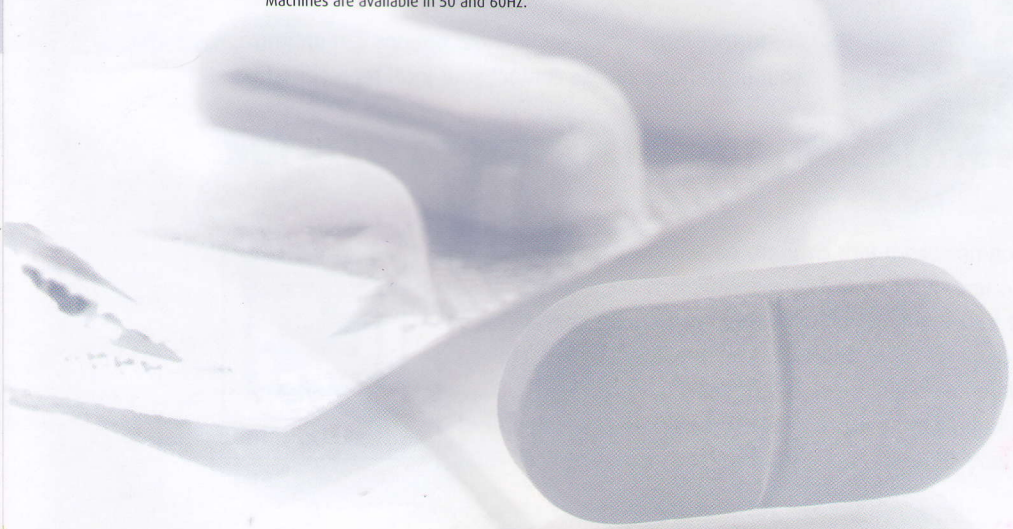

Dimensions (L x W x H)

	Length std mm	Width mm	Height mm
SPR 2-8			
Base-mounted	760	690	840
Base-mounted + dryer	1025	690	840
Tank-mounted 270L	1275	690	1450
Tank-mounted 270L + dryer	1275	690	1450
Tank-mounted 500L	2055	690	1450
Tank-mounted 500L + dryer	2055	690	1450
SPR 10-15	1670	750	1230
SPR 20-30	1630	750	1844

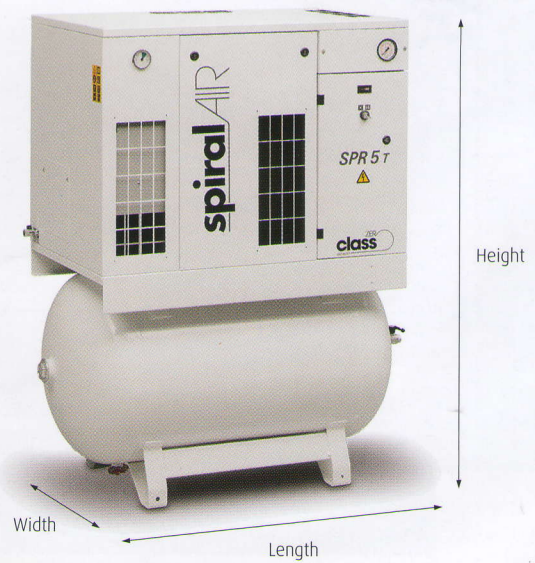
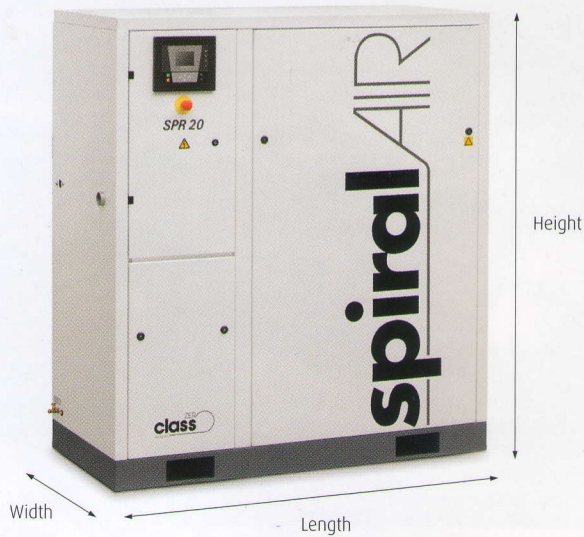



DRIVEN BY TECHNOLOGY DESIGNED BY EXPERIENCE

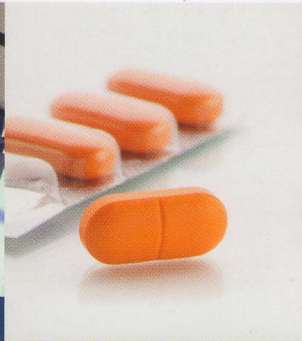
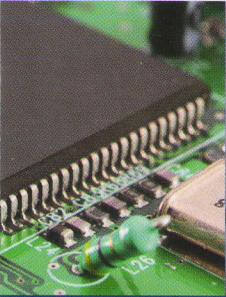

**CONTACT YOUR LOCAL
SALES REPRESENTATIVE**

Your authorised distributor

6999010330

