

BT / NT
series

BSA

Boring Holder

粗搪刀桿

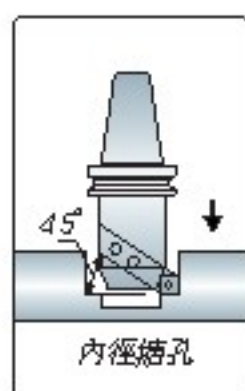
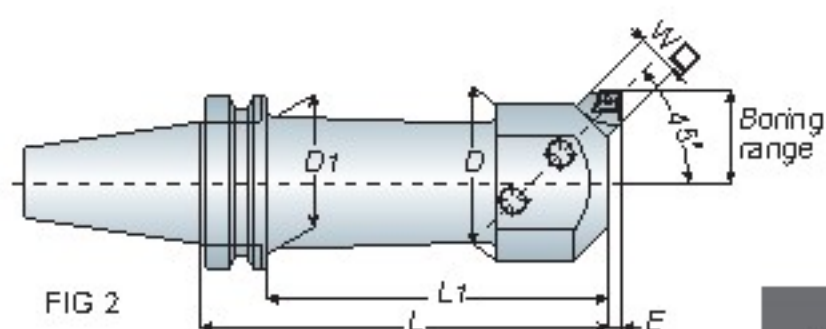
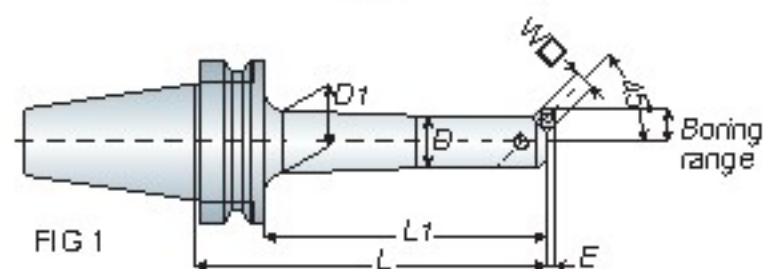

Features

- Throw away boring cutter must be ordered separately and the degree must be 45°.
- When ordering the throw away boring cutter, please check the $W\Box$.
- 捨棄式搪刀架為另購品，內徑搪孔角度需為 45°
- 請於訂購捨棄式搪刀架時，確認 $W\Box$ 尺寸



P76 Boring Cutter

Model No.	FIG.	Boring Range		D	D1	L	L1	E	W \Box	Weight (kg)
		Min.	Max.							
BT30 BSA020-105	1	20	30	17	19	105	85	-	6	0.70
BSA025-120	1	25	38	20	24	120	100	1	8	0.80
160	1	25	38	20	24	160	140	1	8	1.00
BSA030-150	1	30	42	24	28	150	130	1.6	8	1.00
-180	1	30	42	24	28	180	160	1.6	8	1.20
-210	1	30	42	24	28	210	190	1.6	8	1.40
BSA038-165	1	38	52	30	36	165	145	2.6	10	1.40
BSA050-165	1	50	65	40	48	165	145	3	13	1.90
-210	1	50	65	40	48	210	190	3	13	2.40
BT40 BSA025-135	1	25	38	20	24	135	110	1	8	1.40
BSA030-150	1	30	42	24	28	150	125	1.6	8	1.60
BSA038-165	1	38	52	30	36	165	140	2.6	10	2.00
BSA050-165	1	50	65	40	48	165	140	3	13	2.50
-210	1	50	65	40	48	210	185	3	13	2.90
BSA062-165	1	62	90	50	58	165	140	2	16	3.20
-225	1	62	90	50	58	225	200	2	16	4.20
BSA072-165	2	72	110	60	60	165	140	2.4	19	3.90
-225	2	72	110	60	60	225	200	2.4	19	5.20
BSA090-165	2	90	125	75	75	165	140	4	19	4.60
-210	2	90	125	75	75	210	185	4	19	5.30
BT50 BSA025-135	1	25	38	20	24	135	100	1	8	4.20
BSA030-165	1	30	42	24	28	165	130	1.6	8	4.40
BSA038-180	1	38	52	30	36	180	145	2.6	10	4.80
-230	1	38	52	30	36	230	195	2.6	10	5.10
BSA042-210	1	42	56	34	38	210	175	2	10	5.20
-240	1	42	56	34	38	240	205	2	10	5.60
BSA050-180	1	50	65	40	48	180	145	3	13	5.40
-240	1	50	65	40	48	240	205	3	13	6.20
-270	1	50	65	40	48	270	235	3	13	6.50
-300	1	50	65	40	48	300	265	3	13	6.80
BSA062-195	1	62	90	50	58	195	160	2	16	6.40
-240	1	62	90	50	58	240	205	2	16	7.20
-270	1	62	90	50	58	270	235	2	16	7.80
-300	1	62	90	50	58	300	265	2	16	8.30
BSA072-195	1	72	110	60	68	195	160	2.4	19	7.30
-240	1	72	110	60	68	240	205	2.4	19	8.50
-285	1	72	110	60	68	285	250	2.4	19	9.60
-320	1	72	110	60	68	320	285	2.4	19	9.70
BSA090-210	1	90	125	75	74	210	175	4	19	8.60
-250	1	90	125	75	74	250	215	4	19	9.80
-300	1	90	125	75	74	300	265	4	19	11.10
BSA105-195	2	105	160	90	76	195	160	3	25	8.60
-285	2	105	160	90	76	285	250	3	25	11.60

Unit: mm

Boring Holder

粗搪刀桿

BSA

BT / NT

series

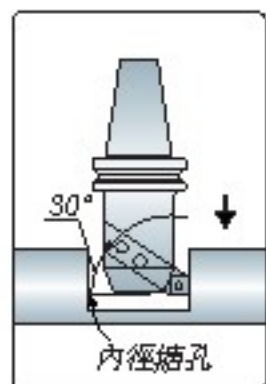
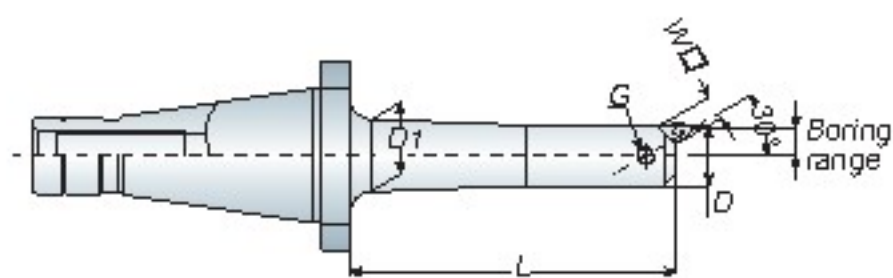

Features

- When ordering, please specify the draw bolt with inch size or metric size.
- Throw away boring cutter must be ordered separately and the degree must be 30°
- When ordering the throw away boring cutter, please check the W □ .
- 請於訂購時，確認刀桿為英制或公制
- 捨棄式搪刀架為另購品，內徑搪孔角度需為 30°
- 請於訂購捨棄式搪刀架時，確認 W □ 尺寸

Model No.	Boring Range		D	D1	L	W □	G	Draw Bolt	Weight (kg)
	Min.	Max.							
NT30 BSA016-100	16	20	14	16	100	6	M06	1/2" -12 M12x1.75P	0.60
BSA020-120	20	25	16	19	120	6	M06		0.70
BSA025-135	25	38	20	24	135	8	M06		0.80
BSA030-165	30	42	24	28	165	8	M06		1.00
BSA038-180	38	52	30	36	180	10	M08		1.40
BSA042-210	42	56	34	38	210	10	M08		1.60
NT40 BSA016-100	16	20	14	16	100	6	M06	5/8" -11 M16x2.0P	1.00
BSA020-120	20	25	16	19	120	6	M06		1.20
BSA025-135	25	38	20	24	135	8	M06		1.30
BSA030-165	30	42	24	28	165	8	M06		1.60
BSA038-180	38	52	30	36	180	10	M08		2.10
BSA042-210	42	56	34	38	210	10	M08		2.40
BSA050-180	50	65	40	48	180	13	M10		2.70
-240	50	65	40	48	240	13	M10		3.40
BSA062-195	62	90	50	58	195	16	M10		3.90
-270	62	90	50	58	270	16	M10		5.30
BSA072-195	72	110	60	68	195	19	M12		4.60
-285	72	110	60	68	285	19	M12		6.00
BSA090-210	90	125	75	-	210	19	M12	5.20	
-300	90	125	75	-	300	19	M12	6.70	
BSA105-195	105	160	90	-	195	25	M16	6.60	
-285	105	160	90	-	285	25	M16	8.20	
NT50 BSA016-100	16	20	14	16	100	6	M06	1" -8 M24x3.0P	3.00
BSA020-120	20	25	16	19	120	6	M06		3.10
BSA025-135	25	38	20	24	135	8	M06		4.00
BSA030-165	30	42	24	28	165	8	M06		4.10
BSA038-180	38	52	30	36	180	10	M08		4.30
-230	38	52	30	36	230	10	M08		4.50
BSA042-210	42	56	34	38	210	10	M08		4.60
-240	42	56	34	38	240	10	M08		4.80
BSA050-180	50	65	40	48	180	13	M10		4.90
-240	50	65	40	48	240	13	M10		5.60
-270	50	65	40	48	270	13	M10		5.90
BSA062-195	62	90	50	58	195	16	M10		5.40
-240	62	90	50	58	240	16	M10		6.20
-270	62	90	50	58	270	16	M10		6.60
BSA072-195	72	110	60	68	195	19	M12		7.00
-240	72	110	60	68	240	19	M12		8.20
-285	72	110	60	68	285	19	M12		9.20
BSA090-210	90	125	75	80	210	19	M12		9.70
-250	90	125	75	80	250	19	M12		11.60
-300	90	125	75	76	300	19	M12		11.30
BSA105-195	105	160	90	68	195	25	M16		8.50
-285	105	160	90	74	285	25	M16		11.40

Unit: mm



BT / NT
series

BSA

Boring Holder

粗搪刀桿

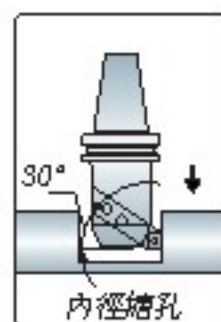
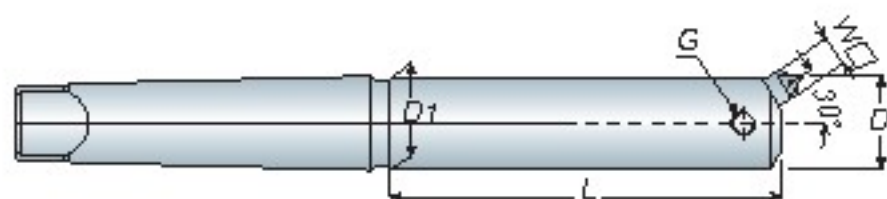

Features

- Throw away boring cutter must be ordered separately and the degree must be 30°
- When ordering the throw away boring cutter, please check the W□.
- 捨棄式搪刀架為另購品，內徑搪孔角度需為 30°
- 請於訂購捨棄式搪刀架時，確認 W□尺寸



P76 Boring Cutter

Model No.	Boring Range		D	D1	L	W□	G
	Min.	Max.					
MTA3 BSA016-100	16	20	14	16	100	6	M06
BSA020-120	20	25	16	19	120	6	M06
BSA025-135	25	38	20	24	135	8	M06
BSA030-165	30	42	24	28	165	8	M06
BSA038-180	38	52	30	36	180	10	M08
BSA042-210	42	56	34	38	210	10	M08
MTA4 BSA016-100	16	20	14	16	100	6	M06
BSA020-120	20	25	16	19	120	6	M06
BSA025-135	25	38	20	24	135	8	M06
BSA030-165	30	42	24	28	165	8	M06
BSA038-180	38	52	30	36	180	10	M08
BSA042-210	42	56	34	38	210	10	M08
MTA5 BSA016-100	16	20	14	16	100	6	M06
BSA020-120	20	25	16	19	120	6	M06
BSA025-135	25	38	20	24	135	8	M06
BSA030-165	30	42	24	28	165	8	M06
BSA038-180	38	52	30	36	180	10	M08
BSA042-210	42	56	34	38	210	10	M08
BSA050-180	50	65	40	48	180	13	M10
-240	50	65	40	48	240	13	M10
BSA062-195	62	90	50	58	195	16	M10
-270	62	90	50	58	270	16	M10
BSA072-195	72	110	60	68	195	19	M12
-285	72	110	60	68	285	19	M12
BSA090-210	90	125	75	-	210	19	M12
-300	90	125	75	-	300	19	M12
BSA105-195	105	160	90	-	195	25	M16
-285	105	160	90	-	285	25	M16
MTA6 BSA016-100	16	20	14	16	100	6	M06
BSA020-120	20	25	16	19	120	6	M06
BSA025-135	25	38	20	24	135	8	M06
BSA030-165	30	42	24	28	165	8	M06
BSA038-180	38	52	30	36	180	10	M08
BSA042-210	42	56	34	38	210	10	M08
BSA050-180	50	65	40	48	180	13	M10
-240	50	65	40	48	240	13	M10
BSA062-195	62	90	50	58	195	16	M10
-270	62	90	50	58	270	16	M10
BSA072-195	72	110	60	68	195	19	M12
-285	72	110	60	68	285	19	M12
BSA090-210	90	125	75	-	210	19	M12
-300	90	125	75	-	300	19	M12
BSA105-195	105	160	90	-	195	25	M16
-285	105	160	90	-	285	25	M16

Unit: mm

Boring Holder

粗搪刀桿

BSB

BT / NT

series

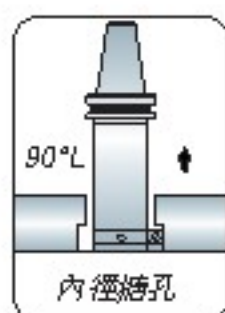
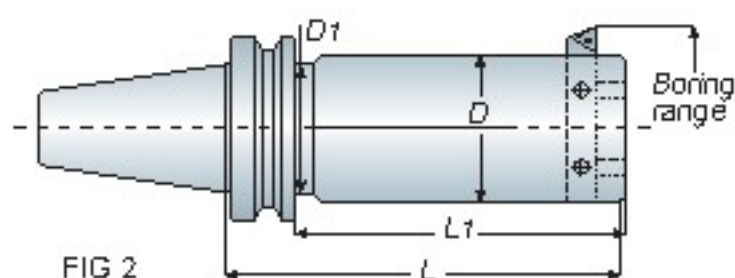
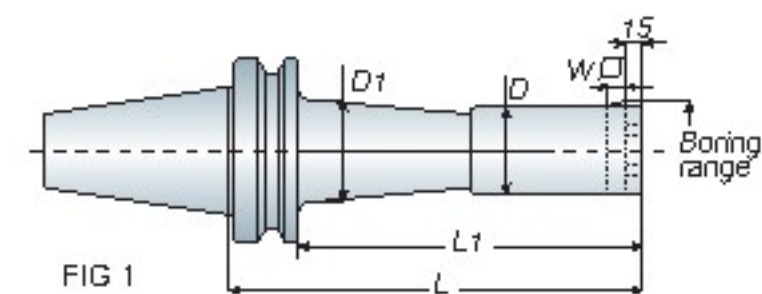

Features

- Throw away boring cutter must be ordered separately and the degree must be 90°.
- When ordering the throw away boring cutter, please check the W□.
- 捨棄式搪刀架為另購品，內徑搪孔角度需為 90°
- 請於訂購捨棄式搪刀架時，確認 W□ 尺寸



P7 G Boring Cutter

Model No.	FIG.	Boring Range		D	D1	L	L1	W□	Weight (kg)		
		Min.	Max.								
BT30 BSB020-105	1	20	30	17	19	105	85	6	0.70		
	BSB025-120	1	25	38	20	24	120	100	8	0.80	
		-160	1	25	38	20	24	160	140	8	1.00
	BSB030-150	1	30	42	24	28	150	130	8	1.00	
		-165	1	30	42	24	28	165	145	8	1.10
		-210	1	30	42	24	28	210	190	8	1.40
BSB038-165	1	38	52	30	36	165	145	10	1.40		
BSB050-165	1	50	65	40	48	165	145	13	1.90		
	-210	1	50	65	40	48	210	190	13	2.40	
BT40 BSB025-135	1	25	38	20	24	135	110	8	1.40		
	BSB038-165	1	38	52	30	36	165	140	10	2.00	
		BSB050-165	1	50	65	40	48	165	140	13	2.80
	-210		1	50	65	40	48	210	185	13	3.40
	BSB062-165	1	62	90	50	56	165	140	16	3.20	
		-225	1	62	90	50	56	225	200	16	4.50
	BSB072-165	2	72	110	60	60	165	140	19	4.40	
		-225	2	72	110	60	60	225	200	19	5.30
	BSB090-165	2	90	125	75	75	165	140	19	5.10	
-210		2	90	125	75	75	210	185	19	6.30	
BT50 BSB025-135	1	25	38	20	24	135	100	8	4.20		
	BSB038-180	1	38	52	30	38	180	145	10	4.90	
		-230	1	38	52	30	38	230	195	10	5.30
	BSB042-210	1	42	56	34	38	210	175	10	5.40	
		-240	1	42	56	34	38	240	205	10	5.60
	BSB050-180	1	50	65	40	48	180	145	13	5.60	
		-240	1	50	65	40	48	240	205	13	6.10
	-270	1	50	65	40	48	270	235	13	6.70	
		-300	1	50	65	40	48	300	265	13	7.20
	BSB062-195	1	62	90	50	58	195	160	16	6.40	
-240		1	62	90	50	58	240	205	16	7.50	
-270		1	62	90	50	58	270	235	16	7.70	
-300		1	62	90	50	58	300	265	16	8.00	
-330		1	62	90	50	58	330	295	16	8.40	
BSB072-195	1	72	110	60	68	195	160	19	8.00		
	-240	1	72	110	60	68	240	205	19	8.60	
	-285	1	72	110	60	68	285	250	19	9.60	
BSB090-210	1	90	125	75	80	210	170	19	8.90		
	-250	1	90	125	75	80	250	215	19	10.80	
	-300	1	90	125	75	80	300	265	19	12.40	
BSB105-195	2	105	160	90	80	195	160	25	9.50		
	-285	2	105	160	90	80	285	250	25	12.20	

Unit: mm

BT / NT
series

BSB

Boring Holder

粗搪刀桿

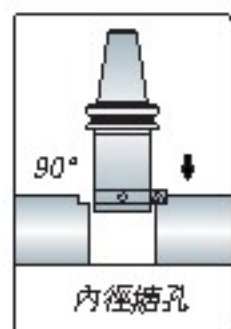
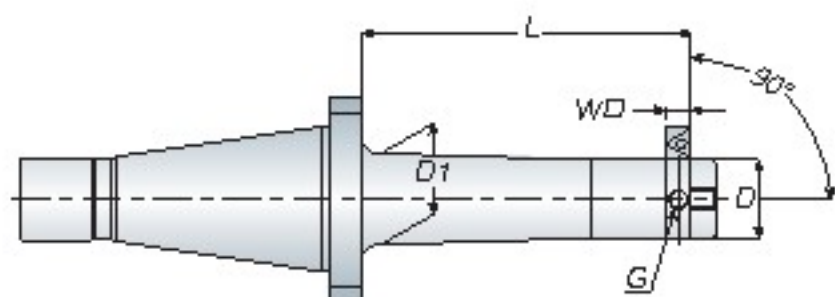

Features

- When ordering, please specify the draw bolt with inch size or metric size.
- Throw away boring cutter must be ordered separately and the degree must be 90°.
- When ordering the throw away boring cutter, please check the W□.
- 請於訂購時，確認刀桿為英制或公制
- 捨棄式搪刀架為另購品，內徑搪孔角度需為 90°
- 請於訂購捨棄式搪刀架時，確認 W□ 尺寸



P76 Boring Cutter

Model No.	Boring Range		D	D1	L	W□	G	Draw Bolt	Weight (kg)
	Min.	Max.							
NT30 BSB016-100	16	20	14	16	100	6	M06	1/2"-12 M12x1.75P	0.60
BSB020-120	20	25	16	19	120	6	M06		0.70
BSB025-135	25	38	20	24	135	8	M06		0.80
BSB030-165	30	42	24	28	165	8	M06		1.00
BSB038-180	38	52	30	36	180	10	M08		1.40
BSB042-210	42	56	34	38	210	10	M08		1.60
BSB050-180	50	65	40	48	180	13	M10		2.00
NT40 BSB016-100	16	20	14	16	100	6	M06	5/8"-11 M16x2.0P	1.00
BSB020-120	20	25	16	19	120	6	M06		1.20
BSB025-135	25	38	20	24	135	8	M06		1.30
BSB030-165	30	42	24	28	165	8	M06		1.60
BSB038-180	38	52	30	36	180	10	M08		2.10
BSB042-210	42	56	34	38	210	10	M08		2.40
BSB050-180	50	65	40	48	180	13	M10		2.70
-240	50	65	40	48	240	13	M10		3.40
BSB062-195	62	90	50	58	195	16	M10		3.90
-270	62	90	50	58	270	16	M10		5.30
BSB072-195	72	110	60	68	195	19	M12	4.60	
-285	72	110	60	68	285	19	M12	6.00	
BSB090-210	90	125	75	-	210	19	M12	5.20	
-300	90	125	75	-	300	19	M12	6.70	
BSB105-195	105	160	90	-	195	25	M16	6.60	
-285	105	160	90	-	285	25	M16	8.20	
NT50 BSB016-100	16	20	14	16	100	6	M06	1"-8 M24x3.0P	3.00
BSB020-120	20	25	16	19	120	6	M06		3.10
BSB025-135	25	38	20	24	135	8	M06		4.00
BSB030-165	30	42	24	28	165	8	M06		4.10
BSB038-180	38	52	30	36	180	10	M08		4.30
-230	38	52	30	36	230	10	M08		4.50
BSB042-210	42	56	34	38	210	10	M08		4.60
-240	42	56	34	38	240	10	M08		4.80
BSB050-180	50	65	40	48	180	13	M10		4.90
-240	50	65	40	48	240	13	M10		5.60
-270	50	65	40	48	270	13	M10		5.90
BSB062-195	62	90	50	58	195	16	M10		5.40
-240	62	90	50	58	240	16	M10		6.20
-270	62	90	50	58	270	16	M10		6.60
BSB072-195	72	110	60	68	195	19	M12		7.00
-240	72	110	60	68	240	19	M12	7.50	
-285	72	110	60	68	285	19	M12	9.20	
BSB090-210	90	125	75	-	210	19	M12	9.70	
-250	90	125	75	-	250	19	M12	11.60	
-300	90	125	75	-	300	19	M12	11.30	
BSB105-195	105	160	90	-	195	25	M16	8.50	
-285	105	160	90	-	285	25	M16	11.40	

Unit: mm

Boring Holder

BSB

BT / NT

series

粗搪刀桿

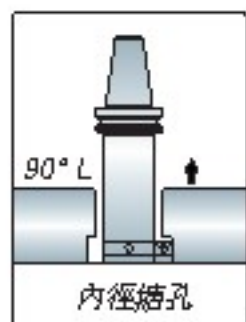
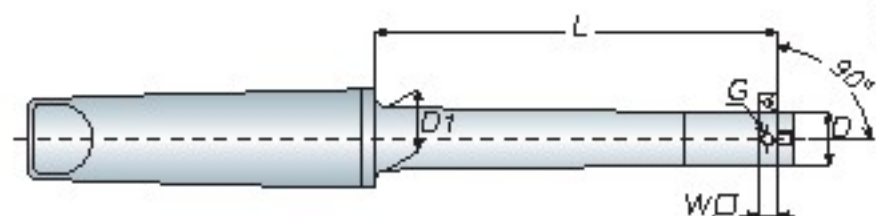

Features

- Throw away boring cutter must be ordered separately and the degree must be 90°.
- When ordering the throw away boring cutter, please check the W□.
- 捨棄式搪刀架為另購品，內徑搪孔角度需為 90°
- 請於訂購捨棄式搪刀架時，確認 W□尺寸

Model No.	Boring Range		D	D1	L	W□	G
	Min.	Max.					
MTA3 BSB016-100	16	20	14	16	100	6	M06
BSB020-120	20	25	16	19	120	6	M06
BSB025-135	25	38	20	24	135	8	M06
BSB030-165	30	42	24	28	165	8	M06
BSB038-180	38	52	30	36	180	10	M08
BSB042-210	42	56	34	38	210	10	M08
BSB050-180	50	65	40	48	180	13	M10
MTA4 BSB016-100	16	20	14	16	100	6	M06
BSB020-120	20	25	16	19	120	6	M06
BSB025-135	25	38	20	24	135	8	M06
BSB030-165	30	42	24	28	165	8	M06
BSB038-180	38	52	30	36	180	10	M08
BSB042-210	42	56	34	38	210	10	M08
BSB050-180	50	65	40	48	180	13	M10
MTA5 BSB016-100	16	20	14	16	100	6	M06
BSB020-120	20	25	16	19	120	6	M06
BSB025-135	25	38	20	24	135	8	M06
BSB030-165	30	42	24	28	165	8	M06
BSB038-180	38	52	30	36	180	10	M08
BSB042-210	42	56	34	38	210	10	M08
BSB050-180	50	65	40	48	180	13	M10
-240	50	65	40	48	240	13	M10
BSB062-195	62	90	50	58	195	16	M10
-270	62	90	50	58	270	16	M10
BSB072-195	72	110	60	68	195	19	M12
-285	72	110	60	68	285	19	M12
BSB090-210	90	125	75	75	210	19	M12
-300	90	125	75	75	300	19	M12
BSB105-195	105	160	95	95	195	25	M16
-285	105	160	95	95	285	25	M16
MTA6 BSB016-100	16	20	14	16	100	6	M06
BSB020-120	20	25	16	19	120	6	M06
BSB025-135	25	38	20	24	135	8	M06
BSB030-165	30	42	24	28	165	8	M06
BSB038-180	38	52	30	36	180	10	M08
BSB042-210	42	56	34	38	210	10	M08
BSB050-180	50	65	40	48	180	13	M10
-240	50	65	40	48	240	13	M10
BSB062-195	62	90	50	58	195	16	M10
-270	62	90	50	58	270	16	M10
BSB072-195	72	110	60	68	195	19	M12
-285	72	110	60	68	285	19	M12
BSB090-210	90	125	75	75	210	19	M12
-300	90	125	75	75	300	19	M12
BSB105-195	105	160	95	95	195	25	M16
-285	105	160	95	95	285	25	M16

Unit: mm

