



Quality and reliability is our tradition

KYORITSU

DIGITAL MULTIMETERS KEW 1051/1052/1061/1062

The Best of Reliable Multimeters with Terminal Safety Shutters

Versatile Multimeters
For Electrical and Electronic
Troubleshooting

KEW 1051/1052

Top Class Multimeters
For Laboratory and
Industrial Use

KEW 1061/1062

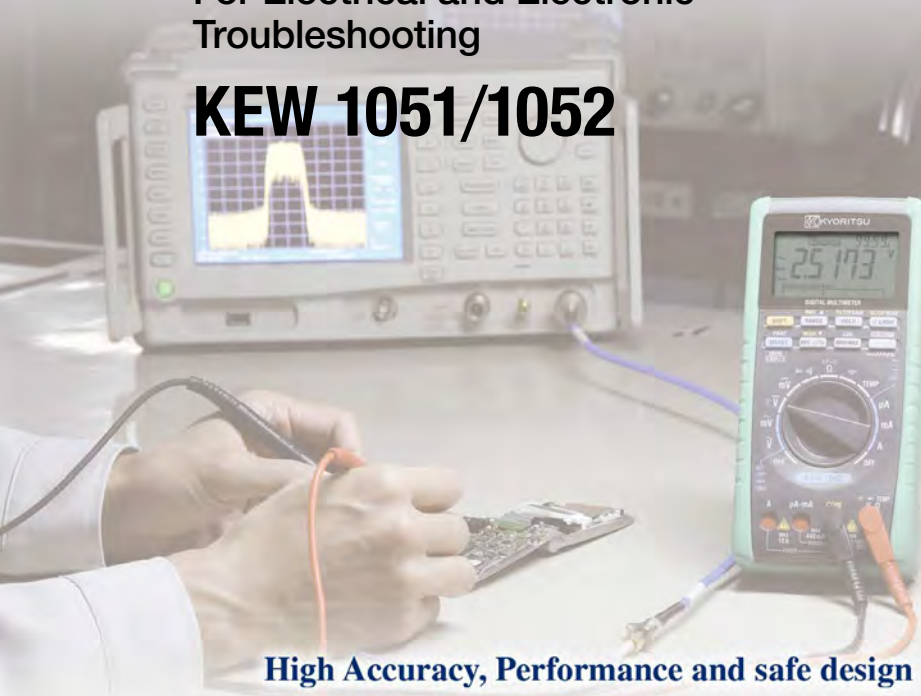

High Accuracy, Performance and safe design



KEW 1051



KEW 1052



KEW 1061



KEW 1062



KYORITSU ELECTRICAL INSTRUMENTS WORKS, LTD.

www.kew-ltd.co.jp

High Accuracy, High Performance and Reliable Measurements

■ Top Accuracy

- 0.02% basic DC accuracy for KEW 1061/1062.
- 0.09% basic DC accuracy for KEW 1051/1052.

■ Dual Display

- KEW 1061/1062 : 50,000 counts, Bar graph with 51 segments. White back light display.
- KEW 1051/1052 : 6,000 counts, Bar graph with 31 segments. White back light display.

■ Wide AC Frequency Bandwidth ※only for 1061, 1062

- KEW 1062 : ACV frequency bandwidth from 10Hz to 100kHz.
- KEW 1061 : ACV frequency bandwidth from 10Hz to 20kHz.

Advanced Functions

■ User calibration function

- Calibration and adjustment are possible by simple operation of DMM keys.
- New technology enables the adjustment for the frequency bandwidth characteristic. ※only for 1061, 1062
※A calibrator is necessary for calibration.

■ Low-pass Filter ※except for 1061

- AC measurement can be limited to low frequency, helping for instance voltage measurements in the presence of variable speed motor drivers or inverters.
- The Low-pass filter can be switched ON/OFF.

■ LowPower-Ω measurement ※only for 1062

- This function uses a test voltage which is lower than 0.7V (that is the typical junction voltage drop of semiconductors) thus it allows testing of resistors on a circuit board without unsoldering them.

■ Selection of the reading mode ※only for 1052, 1062

- Selectable TRMS or MEAN measurement. The presence of distortion in an AC signal can be confirmed, if the measured TRMS and MEAN values are different.

■ Sensor mode ※only for 1051, 1052

- The DMM measures the output voltage of an external sensor (e.g. clamp sensor, light sensor, temperature sensor, etc.) in the secondary display, while the primary display can be set to show the unit of the measured parameter (e.g. A, mA, Lux, °C) according to the conversion ratio chosen.

■ Peak Hold function ※only for 1062

- Response time : 250μs
- The instantaneous peak values can be easily captured where normally it is impossible by MIN/MAX/AVG function.

■ Auto Hold function

- The measured value is held on the display just by removing the test leads from the circuit under test. Users can remain safely concentrated on the measuring point without the need to press the Hold key.

■ Relative and Percentage calculation

- Can calculate and display Relative values or Percentage (%) against the reference measurement values.

■ TRMS Measurement

- Ensures accurate readings, avoiding errors (of up to 50%) which can occur when non-sinusoidal waveforms, created by common non linear loads such as PCs, Inverters, switch-mode power supplies, etc, are measured.

■ DC+AC TRMS Measurement ※only for 1061, 1062

- Accurate AC TRMS measurements also in the presence of superimposed DC component.
- AC and DC values are displayed simultaneously via dual display.



■ Minimum / Maximum / Average function ※except for 1051

- Can record the MIN/MAX/AVG values during the measurement process displaying the data and the elapsed time.

※The average value is shown by dividing the integrated record data by the number of recording time.

■ Duty cycle ratio measurement ※only for 1061, 1062

- The duty cycle ratio is displayed in percentage (%).

■ Decibel dBV, dBm calculation ※only for 1061, 1062

- Can perform logarithmic calculations on AC voltage.

※Reference resistance value:

4/8/16/32/50/75/93/110/125/135/150/200/250/300/500/600/800/900/1000/1200Ω

Safe and Durable Design. Wide Operating Temperature.

■ Complies with IEC 61010-1, CAT IV 600V, CAT III 1000V

■ Safety shutters to prevent incorrect test leads' insertion in current terminals

- Terminal shutters are opening or closing being linked with the rotation of the function switch.

Operation of the Safety Shutters

Safety shutters are open or closed when the appropriate function is selected because they are linked with the rotation of the function switch.

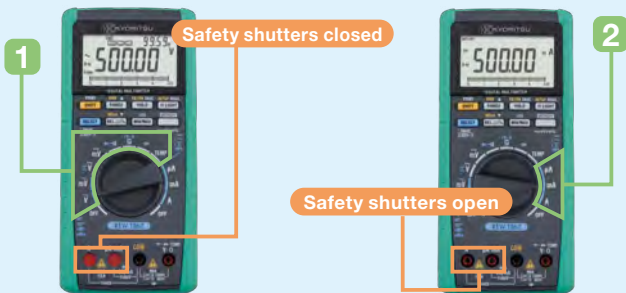

If the DMM has the function switch in position 1 (V, Ω , TEMP, etc) the safety shutters close the input terminals for the current measurements (μ A, mA, A) and then the test leads cannot be plugged-in.

If the DMM has the function switch in position 2 (current measurements) then the safety shutters automatically open making it possible to plug-in the test leads in the input terminals for the current measurements (μ A, mA, A).

■ Very wide operating temperature range

- From -20°C to $+55^{\circ}\text{C}$ for KEW 1061/1062
- From -10°C to $+55^{\circ}\text{C}$ for KEW 1051/1052

■ High specs UL standard fuses for extra safety

- Fuses rated at 1000V with 30kA of breaking capacity.

■ Over molding case

- Made by "Elastomer", a superior shock sustainable material. Perfectly fits to hand.

Reliable support for data management

*except for 1051

■ Large internal memory to store test data

- KEW1062: 10,000 data in Logging mode, 100 data manually saved.
- KEW1061: 1,000 data in Logging mode, 100 data manually saved.
- KEW1052: 1,600 data in Logging mode, 100 data manually saved.
- Logging interval can set from 1 sec. to 30 min.

■ Test data can be transferred to a PC or directly to a Printer*

- Real-time data can be transferred and shown on a PC.
- Real-time transferring permits the saving of a considerable amount of data on a PC.
- Stored data of internal memory can be monitored by PC.

■ Data management with the software DMM Application*

- List of measured data can be converted into Graph.
- Data can be transferred to Excel** and saved as CSV file.

*Optional accessories are required, refer to last page.

**Excel is a registered trademark of Microsoft in the USA.

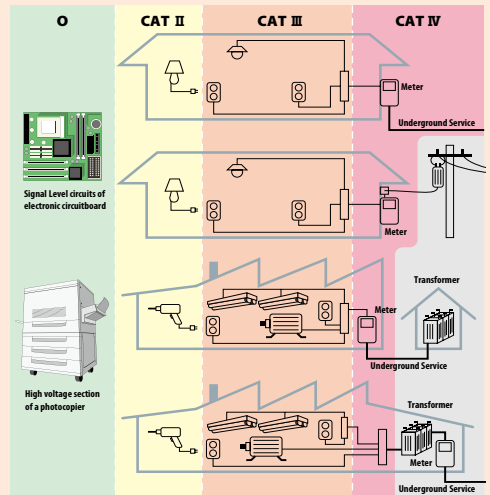

To protect us against overvoltage spikes, we must use instruments that meet the requirements for high protection standards.

The IEC (International Electrotechnical Commission) has prepared an International and European safety standard named IEC 61010-1 with the aim of defining the safety requirements for measuring instruments.

In particular IEC 61010-1 standard defines also the safety Measurement areas called Categories, shortly indicated with the abbreviation "CAT".

These Categories start from O to CAT IV and the most dangerous one is the CAT IV. The figure above shows some area examples of Measurement Categories.

Measurement category	Description	Examples
O	For measurements performed on circuits not directly connected to MAINS.	Signal level circuits of electronic PCBs, etc.
CAT II	For measurements performed on circuits directly connected to the low voltage installation.	Appliances, portable equipment, ect.
CAT III	For measurements performed in the building installation.	Distribution board, circuit breaker, ect.
CAT IV	For measurements performed all the source of the low-voltage installation.	Overhead wire, cable systems, ect.

Printer output

```
L0000 N+12.539 VDC
L0001 N+12.532 VDC
L0002 N+12.532 VDC
L0003 N+12.529 VDC
L0004 N+12.532 VDC
L0005 N+12.538 VDC
L0006 N+12.541 VDC
L0007 N+12.546 VDC
L0008 N+12.552 VDC
L0009 N+12.557 VDC
L0010 N+12.555 VDC
L0011 N+12.554 VDC
L0012 N+12.553 VDC
L0013 N+12.553 VDC
```

Printed items (from the left)

- L: Logging memory
- 4 digit numbers: Data number
- N: Normal measurement
- (O: at "OL" display)
- (B: at "Battery warning" display)
- 5 digit numbers: Measurement
- VDC: Unit (VDC is DC Voltage)

Data analysis with Excel

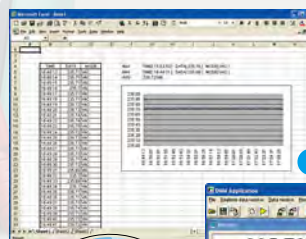

DMM Application software

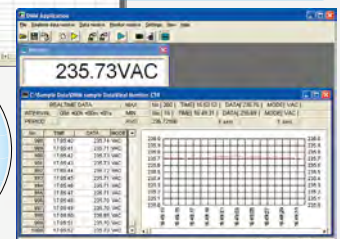

Versatile Digital Multimeters KEW 1051/1052

General Specifications

Measurement function: DC Voltage, AC Voltage, DC Current, AC Current, Resistance, Frequency, Temperature, Capacitor, Continuity Check, Diode Test
 Effective value (root mean square value) detection [RMS] and mean value detection [MEAN] can be switched during AC voltage measurement (KEW1052 only).
 The low-pass filter can be switched on/off during AC voltage or AC current measurement.

Other functions: Data Hold (D-H), Auto Hold (A-H), Range Hold (R-H), Maximum value* (MAX), Minimum value* (MIN), Average value* (AVG), Zero Adjustment (Capacitor, Resistance), Relative values, Save to Memory*, Auto Power Off (Approx. 20 minutes), LCD backlight. *: For model KEW1052 only

Display: 4-digit (LCD).....7-segment
 Main-display.....6000 counts
 Sub-display.....6000 counts
 Bar graph indicator.....31-segment
 Polarity Indicator....."±" Appears automatically when the polarity is negative.
 Overrange Indicator....."OL"
 Low-battery Indicator....."BAT" Appears when the batteries become low.

Measurement cycle: 5 times per second (except frequency measurement : one time per second, Resistance measurement (6M Ω /60M Ω) : 2.5 times per second, capacitor measurement (1000 μ F) : max.0.14 time per second)
 Bar graph display approx 25 times per second (at AC, Ω)

Operating temperature and humidity ranges: -10 to 55°C, 80%RH or less (no condensation) 70%RH or less at 40 to 55°C.

Storage temperature and humidity ranges: -30 to 70°C, 70%RH or less (no condensation)
Temperature coefficient: (Accuracy at 23 \pm 5°C \times 0.1)/°C should be added.
 (Temperature ranges: -10 to 18°C and 28 to 55°C)

Power supply: AA-size (R6/LR6) 1.5V batteries: 4
Battery life: Approximately 300 hours (Operating hours of alkaline batteries when in DC voltage-mode.)
 Note: The battery life varies depending on the operating conditions.

Withstand voltage: 6.88kVrms AC for five seconds (across input terminals and casing)
Dimensions: Approx. 192(L) \times 90(W) \times 49(D)mm
Weight: Approx. 560g (including batteries)
Applicable standards: IEC61010-1 CAT IV 600V, CAT III 1000V Pollution degree 2, IEC61010-031, IEC61326-1
Accessories included: Batteries : 4, Test leads: 1set (Z220A), Fuse (included): 440mA/1000V (8926), 10A/1000V (8927), Instruction manual: 1, Calibration Certificate

Specifications

Test conditions: Temperature and humidity: 23 \pm 5°C at 80%RH or less Accuracy: \pm [% of reading + digits] Note: Each response time is a value to rated accuracy within selected range.

DC Voltage Measurement (\approx V)

Range	Accuracy	Input Impedance	Overload Protection
600.0mV	0.09+2	10M Ω	1000V DC 1000V rms AC
6.000V		11M Ω	
60.00V		10M Ω	
600.0V			
1000V	0.15+2		

NMR: 60dB or more 50/60Hz \pm 0.1% CMRR: 120dB or more 50/60Hz ($R_s=1k\Omega$)
 Response time: 1 sec max.

AC Voltage Measurement (\approx V) AC Coupling: RMS value detection, sine wave MEAN value detection and RMS value calibration (KEW1052 only)

Range	Accuracy			Input Impedance	Overload Protection
	50/60Hz	40~500Hz	500Hz~1kHz		
600.0mV	0.5+5	1+5	1.5+5	10M Ω <200pF	1000V rms AC 1000V DC
6.000V				11M Ω <50pF	
60.00V				10M Ω <50pF	
600.0V					
1000V					

Accuracy: At 5 to 100% of range and 1000V range is 200 to 1000V. less than 1500V peak For non-sinusoidal waveforms, add \pm (2% + 2% of full scale), for Crest factor<3.
 CMRR: 60dB or more DC to 60Hz ($R_s=1k\Omega$) 4 counts or less is corrected to 0, Response time: 2 sec max.

Resistance Measurement (Ω)

Range	Accuracy	Maximum Measuring Current	Open Circuit Voltage	Overload Protection
600.0 Ω	0.4+1	<1.2mA	<3.5V	1000V rms
6.000k Ω		<110 μ A		
60.00k Ω		<13 μ A		
600.0k Ω		<1.3 μ A		
6.000M Ω	0.5+1	<130nA	<1.3V	1000V rms
60.00M Ω	1+2(0~40M Ω) 2+2(40~60M Ω)			

Accuracy is specified after zero adjustment at 600 Ω to 6k Ω (Resistance)
 Response time: 2 sec max. at 600 Ω to 600k Ω , 10 sec max. at 6M to 60M Ω

Continuity Check (\approx)

Range	Range of Operation	Measuring Current	Open Circuit Voltage	Overload Protection
600.0 Ω	Buzzer sounds at lower than 50 \pm 30 Ω	Approx.<1.2mA	<3.5V	1000V rms

DC Current Measurement (\approx (A))

Range	Accuracy	Voltage Drop	Overload Protection
600.0 μ A	0.2+2	<0.12mV/ μ A	440mA Protected by a 440mA/1000V fuse.
6000 μ A		<3.3mV/mA	
60.00mA			
440.0mA			
6.000A	0.5+5	<0.1V/A	10A Protected by A 10A/1000V fuse.
10.00A			

Response time: 1 sec max.

AC Current Measurement [RMS] (\approx A) RMS value detection, sine wave

Range	Accuracy		Voltage Drop	Overload Protection
	50/60Hz	40Hz~1kHz		
600.0 μ A	0.75+5	1.5+5	<0.12mV/ μ A	440mA Protected by a 440mA/1000V fuse.
6000 μ A			<3.3mV/mA	
60.00mA				
440.0mA				
6.000A	0.5+5	1.5+5	<0.1V/A	10A Protected by A 10A/1000V fuse.
10.00A				

Accuracy: At 5 to 100% of range, 10A range is 2 to 10A and 440mA range is 30 to 440mA.
 For non-sinusoidal waveforms, add \pm (2% + 2% of full scale), for Crest factor<3.
 4 counts or less is corrected to 0, Response time: 3 sec max.

Diode Test (\approx)

Range	Accuracy	Measuring Current(V \approx 0.6V)	Open Circuit Voltage	Overload Protection
2.000V	1+2	Approx. 0.5mA	<3.5V	1000V rms

Temperature Measurement (TEMP)

Range	Accuracy	Overload Protection
-50.0~600.0°C	2+2°C	1000V rms

Use optional Temperature Probe: Thermocouple Type K

Capacitor Measurement (\approx)

Range	Accuracy	Overload Protection
10.00nF	2+10	1000V rms
100.0nF		
1.000 μ F		
10.00 μ F		
100.0 μ F	3+5	1000V rms
1000 μ F		

Accuracy is specified after zero adjustment at 10nF to 1 μ F (Capacitance)

Frequency Measurement (Hz) AC Coupling, Maximum Reading 9999

Range	Accuracy	Input Voltage
10.00~99.99Hz	0.02+1	0.2~600Vrms
90.0~999.9Hz		0.4~600Vrms
0.900~9.999kHz		
9.00~99.99kHz		

Selection Guide

Model	1051	1052	1061	1062
Display				
Detection method	RMS	RMS/MEAN	RMS	RMS/MEAN
Maximum count display	6000	6000	50000	50000
Dual display	●	●	●	●
Bar graph	31-segment	31-segment	51-segment	51-segment
Back light	White LED	White LED	White LED	White LED
Function				
Auto hold	●	●	●	●
Peak hold	—	—	—	—
Max/Min/Ave	—	●	●	●
REL	●	●	●	●
Manual memory	—	●	●	●
Logging memory	—	●	●	●
Communication	—	●	●	●
Frequency response	40Hz~1kHz	40Hz~1kHz	10Hz~20kHz	10Hz~100kHz
Operating temperature	-10°C~55°C	-10°C~55°C	-20°C~55°C	-20°C~55°C
Safety standard	CAT III 1000V CAT IV 600V	CAT III 1000V CAT IV 600V	CAT III 1000V CAT IV 600V	CAT III 1000V CAT IV 600V

Model	1051	1052	1061	1062
Measurement				
DC Voltage	600.0mV~1000V	600.0mV~1000V	50.00mV~1000.0V	50.00mV~1000.0V
AC Voltage	600.0mV~1000V	600.0mV~1000V	500.0mV~1000.0V	50.00mV~1000.0V
DC Current	600.0 μ A~10.00A	600.0 μ A~10.00A	500.0 μ A~10.000A	500.0 μ A~10.000A
AC Current	600.0 μ A~10.00A	600.0 μ A~10.00A	500.0 μ A~10.000A	500.0 μ A~10.000A
AC+DC	—	—	●	●
Resistance	600.0 Ω ~60.00M Ω	600.0 Ω ~60.00M Ω	500.00 Ω ~50.000M Ω	500.00 Ω ~50.000M Ω
Frequency	10.00Hz~99.99kHz	10.00Hz~99.99kHz	2.000Hz~99.99kHz	2.000Hz~99.99kHz
Temperature	-50.0~600.0°C	-50.0~600.0°C	-200.0~1372.0°C	-200.0~1372.0°C
Capacitance	10.00nF~1000 μ F	10.00nF~1000 μ F	5.000nF~50mF	5.000nF~50mF
Duty cycle	—	—	●	●
Decibel calculation	—	—	●	●
Continuity Check	●	●	●	●
Diode Test	●	●	●	●
Low power- Ω	—	—	—	●

Top-Class Digital Multimeters KEW 1061/1062

General Specifications

Measurement function: DC Voltage, AC Voltage, DC Current, AC Current, Resistance, Frequency, Temperature, Capacitor, Duty cycle ratio, Decibel (dBv, dBm), Continuity Check, Diode Test Low power-□*, Effective value (root mean square value) detection (RMS) and mean value detection (MEAN) can be switched during AC voltage or AC current measurement (KEW1062 only).
The low-pass filter can be switched on/off during AC voltage or AC current measurement (KEW1062 only).

Other functions: Data Hold (D·H), Auto Hold (A·H), Peak Hold* (P·H), Range Hold (R·H), Maximum value (MAX), Minimum value (MIN), Average value (AVG), Zero Adjust-ment (Capacitor, Resistance), Relative values, Save to Memory, Auto Power Off (Approx. 20 minutes), LCD backlight. *: For model KEW1062 only

Display: 5-digit (LCD).....7-segment
Main-display.....50000 counts
Sub-display.....50000 counts
Bar graph indicator.....51-segment
Polarity Indicator.....“—” Appears automatically when the polarity is negative.
Overrange Indicator.....“OL”
Low-battery Indicator.....“” Appears when the batteries become low.

Measurement cycle: 6 times per second (except frequency measurement: one time per second, Resistance measurement : four times per second, capacitor measurement (50mF): max. 0.03 time per second) Bar graph display 15 times per second

Operating temperature and humidity ranges: -20 to 55°C, 80%RH or less (no condensation), 70%RH or less at 40 to 55°C.

Storage temperature and humidity ranges: -40 to 70°C, 70%RH or less (no condensation)

Temperature coefficient: (Accuracy at 23±5°C×0.05)/°C or less
(Temperature ranges: -20 to 18°C and 28 to 55°C)

Power supply: AA-size (R6) 1.5V batteries: 4

Battery life: Approximately 120 hours
(Operating hours of alkaline batteries when in DC voltage-mode.)
Note: The battery life varies depending on the operating conditions.

Withstand voltage: 6.88kVrms AC for five seconds (across input terminals and casing)

Dimensions: Approx. 192(L)×90(W)×49(D)mm

Weight: Approx. 560g (including batteries)

Applicable standards: IEC61010-1 CAT IV 600V, CAT III 1000V Pollution degree 2, IEC61010-031, IEC61326-1(EMC)

Accessories included: Batteries : 4, Test leads: 1set (7220A), Fuse (included): 440mA/1000V (8926), 10A/1000V (8927), Instruction manual: 1, Calibration Certificate

Specifications

Test conditions: Temperature and humidity: 23±5°C at 80%RH or less Accuracy: ± (% of reading + digits) Note: Each response time is a value to rated accuracy within selected range.

DC Voltage Measurement (≡V)

Range	Accuracy 1061,1062	Input Impedance	Overload Protection
50.000mV	0.05+10	Approx. 100MΩ	1000V DC 1000V rms AC
500.00mV	0.02+2		
2400.0mV			
5.0000V	0.025+5	10MΩ	
50.000V	0.03+2		
500.00V			
1000.0V			

NMR: 80dB or more 50/60Hz ±0.1% (70dB or more 50/60Hz ±0.1% when 50mV Range)
CMRR: 100dB or more 50/60Hz (Rs=1kΩ) Response time: 0.3 sec. max.

AC Voltage Measurement [RMS] (∼V) AC Coupling, RMS value detection, sine wave

Range	Accuracy [Upper:1061; Lower:1062; —:Not Specified]					Input Impedance	Overload Protection
	10~20Hz	20Hz~1kHz	1k~10kHz	10k~20kHz	20k~50kHz		
50.000mV	2+80 ^{※2}	0.4+40 ^{※2}	5+40 ^{※2}	5.5+40 ^{※2}	15+40 ^{※2}	11MΩ<50pF	1000V rms AC 1000V DC
500.00mV	1.5+30 ^{※1}	0.7+30 ^{※1}	2+50 ^{※2}	—	—		
5.0000V	1+30 ^{※1}	0.4+30 ^{※1}	1+40 ^{※1}	2+70 ^{※2}	5+200 ^{※2}	10MΩ<50pF	
50.000V	※2	※2	3+30 ^{※2}	—	—		
1000.0V	※2	※2	3+30 ^{※2}	—	—		

※1: At 5 to 100% of range
※2: At 10 to 100% of range
Crest factor <1.5V at 1000V range; Crest factor <3 at other range
CMRR: 80dB or more DC to 60Hz (Rs=1kΩ) Response time: 1 sec. max.

AC Voltage Measurement [MEAN] (∼V) ※1062 only AC Coupling, RMS value detection, sine wave

Range	Accuracy			Input Impedance	Overload Protection
	10~20Hz	20~500Hz	500~1kHz		
50.000mV	4+80 ^{※2}	1.5+30 ^{※2}	5+30 ^{※2}	11MΩ<50pF	1000V rms AC 1000V DC
500.00mV	2+30 ^{※1}	1+30 ^{※1}	3+30 ^{※1}		
5.0000V					
50.000V					
500.00V	※2	※2	※2		
1000.0V	※2	※2	※2		

※1: At 5 to 100% of range
※2: At 10 to 100% of range
CMRR: 80dB or more DC to 60Hz (Rs=1kΩ) Response time: 1 sec. max.

DCV+ACV (≡ + ∼) AC Coupling, RMS value detection, sine wave

Range	Accuracy [Upper:1061; Lower:1062; —:Not Specified]						Input Impedance	Overload Protection
	DC,10~20Hz	DC,20Hz~1kHz	DC,1k~10kHz	DC,10k~20kHz	DC,20k~50kHz	DC,50k~100kHz		
5.0000V	1.5+10 ^{※1}	1+10 ^{※1}	2+10 ^{※2}	—	—	11MΩ<50pF	1000V rms AC 1000V DC	
50.000V	1.5+10 ^{※1}	0.5+10 ^{※1}	1+10 ^{※1}	2+10 ^{※2}	5+20 ^{※2}			
500.00V								
1000.0V						※2	※2	—

※1: At 5 to 100% of range
※2: At 10 to 100% of range
Crest factor <1.5V at 1000V range; Crest factor <3 at other range
CMRR: 80dB or more DC to 60Hz (Rs=1kΩ) Response time: 2 sec. max.

Resistance Measurement (Ω)

Range	Accuracy		Maximum Measuring Current	Open Circuit Voltage	Overload Protection
	1061	1062			
500.0Ω	0.1+2 ^{※1}	0.05+2 ^{※1}	<1mA	<2.5V	1000V rms
5.000kΩ			<0.25mA		
50.00kΩ			<25μA		
500.0kΩ			<2.5μA		
5.000MΩ			<1.5μA		
50.00MΩ			<0.13μA		

Accuracy is specified after zero adjustment (resistance).
Response time: 1 sec. max. at 500Ω to 500kΩ, 5 sec. max. at 5MΩ to 50MΩ

LowPower-Ω (LP-Ω) ※1062 only Maximum Reading 5000

Range	Accuracy	Maximum Measuring Current	Open Circuit Voltage	Overload Protection
5.000kΩ	0.2+3	<10μA	<0.7V	1000V rms
50.00kΩ		<1.0μA		
500.0kΩ		<0.6μA		
5.000MΩ		<0.05μA		

Continuity Check (⊞) Maximum Reading 5000

Range	Range of Operation	Measuring Current	Open Circuit Voltage	Overload Protection
500.0Ω	Buzzer sounds at lower than 100±50Ω	Approx. 0.5mA	<5V	1000V rms

DC Current Measurement (≡A)

Range	Accuracy 1061,1062	Voltage Drop	Overload Protection
500.00μA	0.2+5	<0.11mV/μA	440mA Protected by a 440mA/1000V fuse.
5000.0μA		<4mV/mA	
50.000mA			
500.00mA			0.6+10
10.000A		0.6+5	

Maximum measurement current : 440mA at 500mA range
Response time: 0.3 sec. max.

AC Current Measurement [RMS] (∼A) RMS value detection, sine wave

Range	Accuracy [Upper:1061; Lower:1062; —:Not Specified]			Voltage Drop	Overload Protection
	10~20Hz	20Hz~1kHz	1k~5kHz		
500.00μA	1.5+20	1+20	0.75+20	<0.11mV/μA	440mA Protected by a 440mA/1000V fuse.
5000.0μA					
50.000mA				1+30	<4mV/mA
500.00mA	1.5+20	1+20	2+30	<0.1V/A	10A Protected by a 10A/1000V fuse.
5.0000A					
10.000A					

Accuracy At 5 to 100% of range, At 10 to 100% of range for 10A Range
440mA at 500mA range
Crest factor<3. Response time: 1 sec. max.

AC Current Measurement [MEAN] (∼A) ※1062 only MEAN value detection, RMS value calibration

Range	Accuracy			Voltage Drop	Overload Protection
	10~20Hz	20~500Hz	500Hz~1kHz		
500.00μA	2+20	1.5+20	2+30	<0.11mV/μA	440mA Protected by a 440mA/1000V fuse.
5000.0μA					
50.000mA				<4mV/mA	
500.00mA ^{※3}					
5.0000A					3+20
10.000A					

Accuracy At 5 to 100% of range, At 10 to 100% of range for 10A Range
440mA at 500mA range Response time: 1 sec. max.

DCA+ACA (≡ + ∼) Maximum Reading 5000

Range	Accuracy [Upper:1061; Lower:1062; —:Not Specified]			Voltage Drop	Overload Protection
	DC,10~20Hz	DC,20Hz~1kHz	DC,1k~5kHz		
500.00μA	2+10	1.5+10	1.5+10	<0.11mV/μA	440mA Protected by a 440mA/1000V fuse.
5000.0μA					
50.000mA				<4mV/mA	
500.00mA ^{※3}					
5.0000A					2+10
10.000A					

Accuracy At 5 to 100% of range, At 10 to 100% of range for 10A Range
440mA at 500mA range
Crest factor<3. Response time: 2 sec. max.

Diode Test (⊛)

Range	Accuracy 1061,1062	Measuring Current (I _F =0.6V)	Open Circuit Voltage	Overload Protection
2.4000V	1+2	Approx. 0.5mA	<5V	1000V rms

Temperature Measurement (TEMP)

Range	Accuracy 1061,1062	Overload Protection
-200.0~1372.0°C	1+1.5°C	1000V rms

Use optional Temperature Probe: Thermocouple Type K

Frequency Measurement (Hz)

AC Coupling, Maximum Reading 9999	
Range (AUTO)	Accuracy 1061,1062
2.000~9.999Hz	0.02+1 ^{※1}
9.00~99.99Hz	
90.0~999.9Hz	
9.000~9.999kHz	
9.00~99.9kHz	
9.00~999.9kHz	

※1: At 10 to 100% of input voltage or current range
※2: At 40 to 100% of input voltage or current range

Capacitor Measurement (⊞) Maximum Reading 5000

Range	Accuracy 1061,1062	Overload Protection
5.000nF	1+5 ^{※1}	1000V rms
50.00nF		
500.0nF		
5.000μF		
50.00μF		
500.0μF		
5.000mF		
50.00mF	3+5	

※1: Accuracy is specified after zero adjustment (capacitor).

Duty cycle ratio (%)

Range	Accuracy 1061,1062
10~90%	±1% ^{※1}

※1: At 10.00Hz to 500.0Hz, square wave At 40 to 100% of input voltage or current range

Peak Hold (P·H) ※1062 only

Maximum Reading 5000		
Range	Resolution	Response Time Maximum
DCV, DCA	±100 digit	>250μs

● Included Accessories

Description	MODEL	Contents
Test leads	7220A	CAT IV 600V, CAT III 1000V 1set
Fuse	8926	440mA/1000V×1
	8927	10A/1000V×1



Test leads (7220A)

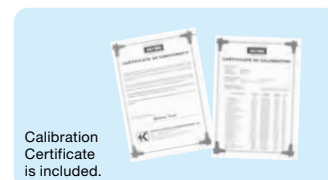

Calibration Certificate is included.

● Optional Accessories

Description	MODEL	Contents
Alligator Clip	7234	CAT IV 600V, CAT III 1000V 1set
USB Communication set	8241	USB adaptor+USB cable+DMM Software
	8405	Max. 500°C (Surface type, Point material: Ceramic)
Thermocouple Type K	8406	Max. 500°C (Surface type)
	8407	Max. 700°C (Liquid, Semi-solid)
	8408	Max. 600°C (Air, Gas)
	8121	AC 100A
Clamp sensor	8122	AC 500A
	8123	AC 1000A
	8146	AC 30A
	8147	AC 70A
	8148	AC 100A
	Banana Ø4mm Adjuster Plug	7146
Carrying case	9154	Soft case (for the main unit with test leads and communication cable)

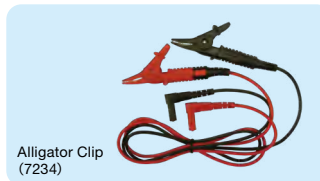

Alligator Clip (7234)



USB Communication set (8241)



Carrying case (9154)



Banana Ø4mm adjuster plug (7146)

● Clamp sensor Specification

MODEL	AC/DC current sensor		AC current sensor				Leakage & AC current sensor	
	8115	8121	8122	8123	8146	8147	8148	
Conductor size	φ12	φ24	φ40	φ55	φ24	φ40	φ68	
Rated current	AC 130A / DC 180A	AC 100A	AC 500A	AC 1000A	AC 30A	AC 70A	AC 100A	
Output voltage	AC/DC 10mV/A	AC 500mV/100A	AC 500mV/500A	AC 500mV/1000A	AC 1500mV/30A	AC 3500mV/70A	AC 5000mV/100A	
Accuracy (50/60Hz)	AC ±1.0%rdg±0.4mV DC ±1.0%rdg±0.4mV (This accuracy is defined after a zero-adjustment)	±2.0%rdg±0.3mV			0~15A ±1.0%rdg±0.1mV 15~30A ±5.0%rdg	0~40A ±1.0%rdg±0.1mV 40~70A ±5.0%rdg	0~80A ±1.0%rdg±0.1mV 80~100A ±5.0%rdg	
Frequency range	40Hz~1kHz							
Dimensions	127(L)×42(W)×22(D)mm	97(L)×59(W)×26(D)mm	128(L)×81(W)×36(D)mm	170(L)×105(W)×48(D)mm	100(L)×60(W)×26(D)mm	128(L)×81(W)×36(D)mm	186(L)×129(W)×53(D)mm	
Weight	approx. 160g	approx. 150g	approx. 260g	approx. 360g	approx. 150g	approx. 240g	approx. 510g	

※ Other Kyoritsu clamp sensors can be used with these DMMs, please check our website for more info. ※ Banana φ4 mm adjuster plug [7146] is required to use these sensors with the DMMs, with the exception for the 8115.

● Thermocouple Type K Specification

Model	Usage	Measurement temperature	Tolerance (t: measurement temperature)	Response speed
8405	(Surface type, Point material: Ceramic)	Max. 500°C	±2.5°C/t=-40°C~333°C, ±0.0075× t °C/t=333°C~500°C	approx. 1.8 Sec.
8406	Surface type			approx. 1.0 Sec.
8407	(Liquid, Semi-solid)	Max. 700°C	±2.5°C/t=-40°C~333°C, ±0.0075× t °C/t=333°C~700°C	1 Sec. or less
8408	(Air, Gas)	Max. 600°C		±2.5°C/t=-40°C~333°C, ±0.0075× t °C/t=333°C~600°C



MODEL 8405



MODEL 8406

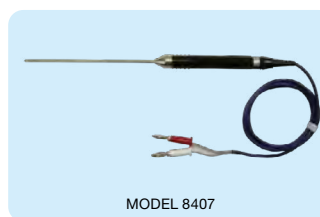

MODEL 8407

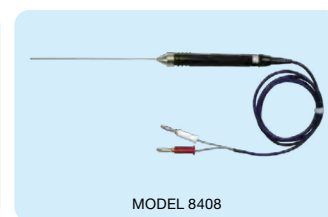

MODEL 8408

! Safety Warnings : Please read the "Safety Warnings" in the instruction manual supplied with the instrument thoroughly and completely for correct use. Failure to follow the safety rules can cause fire, trouble, electrical shock, etc. Therefore, make sure to operate the instrument on a correct power supply and voltage rating marked on each instrument.

■ For inquires or orders :

KYORITSU ELECTRICAL INSTRUMENTS WORKS, LTD.

2-5-20, Nakane, Meguro-ku, Tokyo, 152-0031 Japan
Phone:+81-3-3723-0131
Fax:+81-3-3723-0152
E-mail:info-eng@kew-ltd.co.jp

www.kew-ltd.co.jp

