

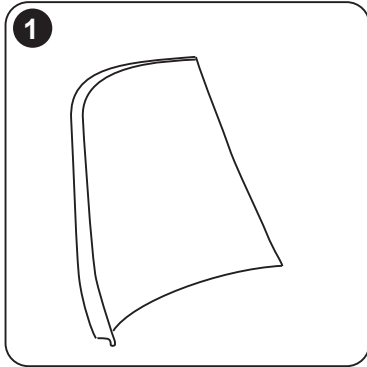

INSTRUCTIONS FOR SF3 & SF5 Feather & Tear Drop Flag

bag includes: Your (*feather or teardrop*) flag kit ,5 piece pole in a Carry Bag & depending on what you have ordered, a Cross Base
(only *SF3* have Waterbag)



1 Lay your Flag flat.

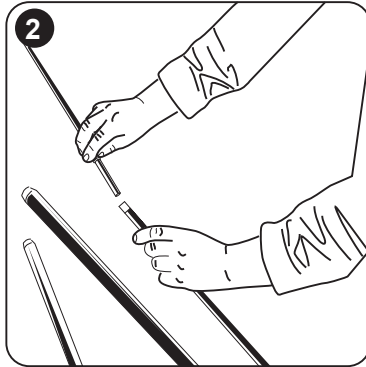

2 Continue joining subsequent thickness Pole sections until the protected end of the Pole has reached the end of the Flag sleeve at the top of the Flag

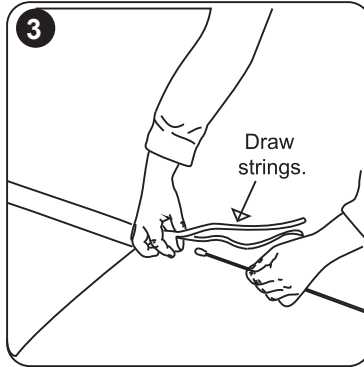

3 Insert the thinnest Pole section protected end first into the Flag sleeve.

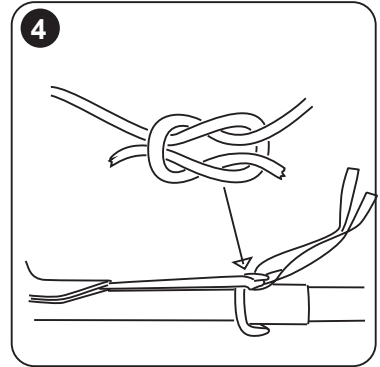

4 Tension the draw strings until the best result for the Banner is achieved. It is advisable to tie a reef knot as shown.

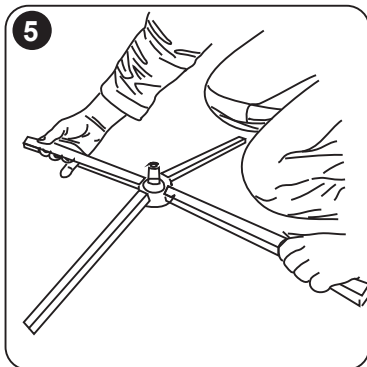

5 Ensure the notched bar Cross Base is underneath.

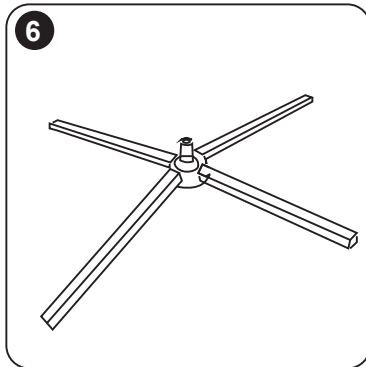

6 Base shown assembled for indoor or outdoor use.

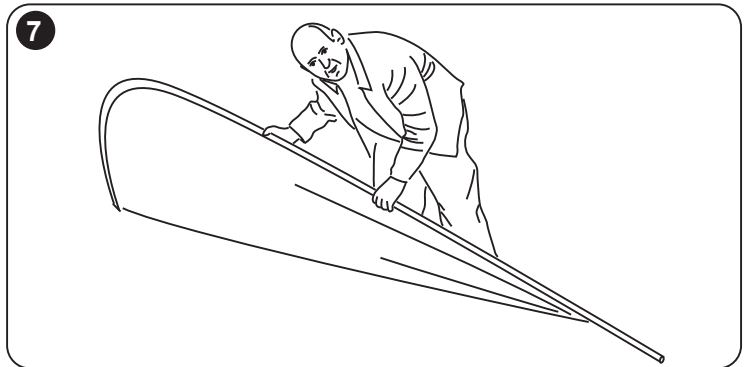

7 Fit the assembled Flag, either Feather or Teardrop style, on to either the Cross Base

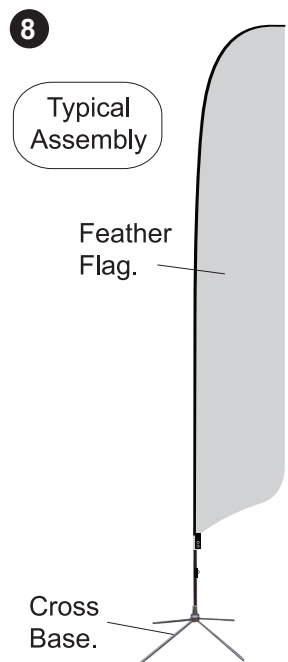

8 Typical Assembly

Feather Flag.

Cross Base.

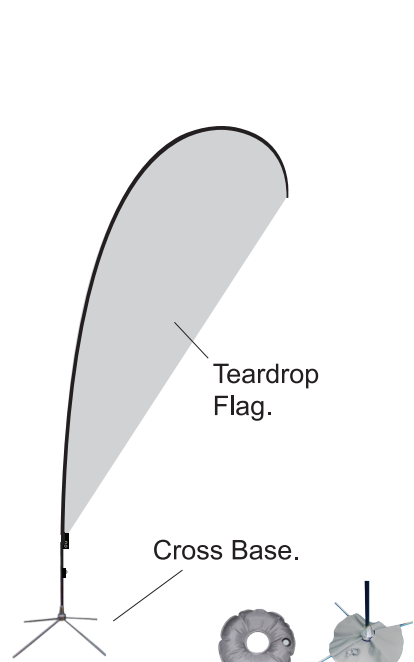

Teardrop Flag.

Cross Base.

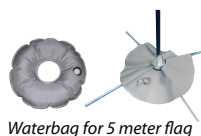

Waterbag for 5 meter flag

Using the Waterbag. Optional for outdoor use.



Fill the Waterbag.



Tighten the cap.

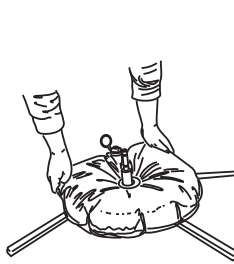

Place onto the Cross Base.

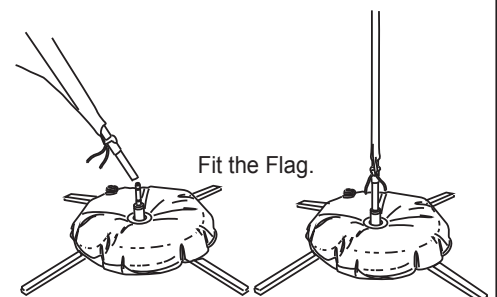

Fit the Flag.