



OMRON

CJ Series

Programmable Controllers

CJ1G-CPU□□P Loop-control CPU Unit

Unit Version 3.□

CJ1 Special I/O Units

Process Analog Input Units

(Isolated Units with Fully Universal Inputs)

CJ1W-PH41U (High-resolution Unit) and CJ1W-AD04U (General-purpose Unit)

Fully Integrated Sequence and Loop Control

New Built-in Loop Controller

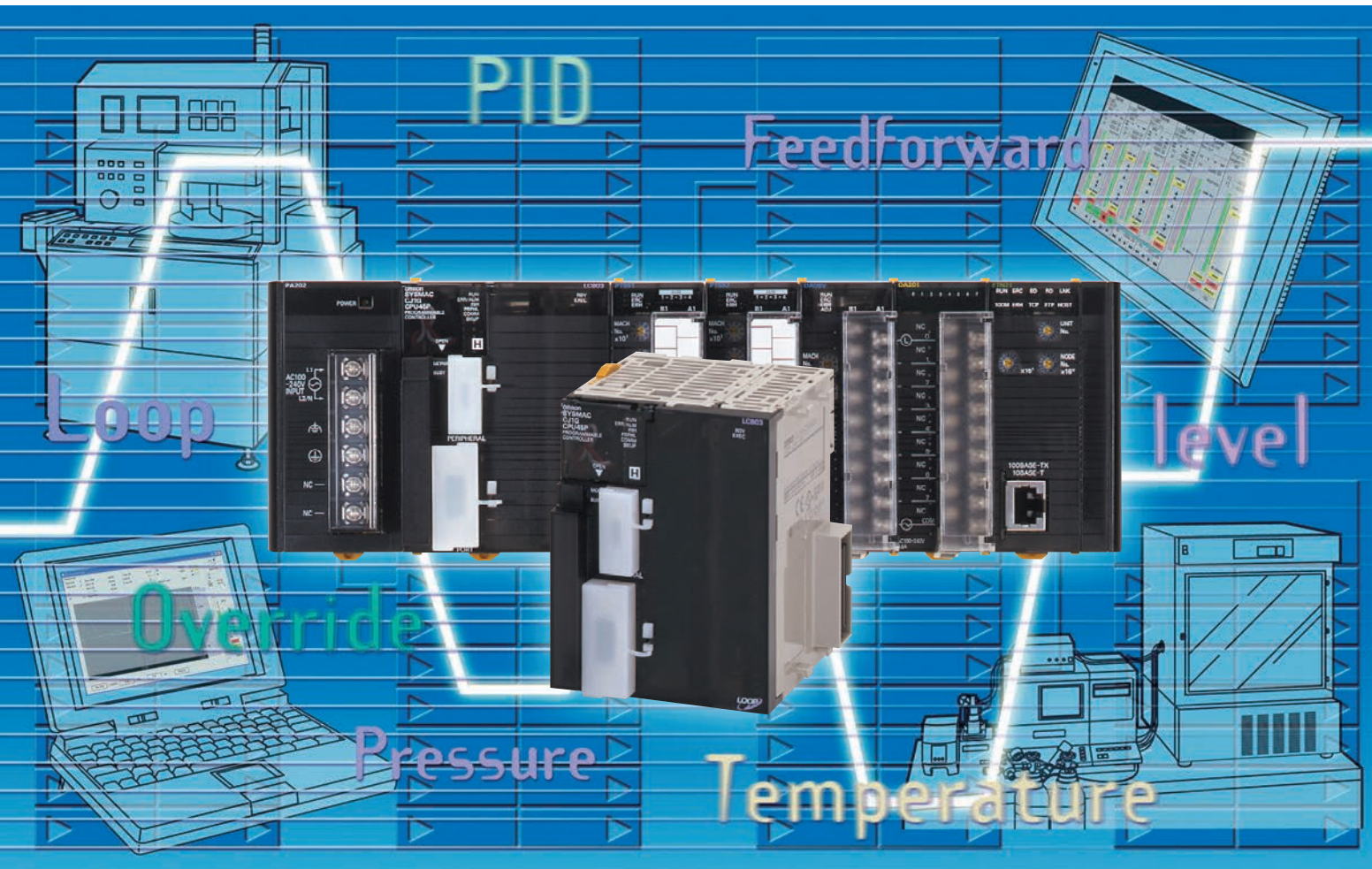
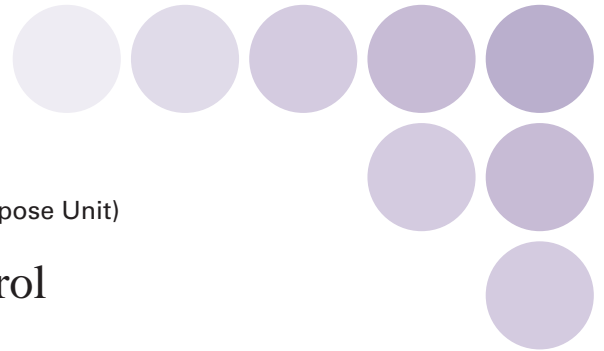

realizing

SMARTPROCESS
CONTROL



Introducing the New Style of Loop Control

Advanced controller functions integrated with the same CJ-series functionality and high-speed capabilities

Down-sizing

- Ultra-small size fits in most devices
- Backplane-free structure provides the functions you need in minimum space.
- Low-cost solution for controlling multiple loops

SMARTPROCESS CONTROL

Easy Engineering

- Function block programming for easy engineering
- Seamless integration of sequence control and loop control.
- HMI windows can be simply generated from function blocks automatically.

High Reliability

- Control functions have the added ability to control multiple loops.
- Consolidating the proven CS-series loop-control technology
- Effective maintenance functions

Integrated Loop Control and Sequence Control

An engine for controlling analog quantities (e.g., temperature, pressure, flowrate) is built into the CPU Unit together with the engine for executing sequence control, delivering high-speed sequence control and high-speed, advanced analog quantity control in a single Unit.

Sequence Control Engine

CPU Unit element:
CJ1G-CPU4□H

CX-Programmer sequence control program (ladder, function block, structured text)

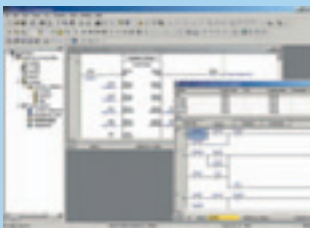

Execute **20-Kstep** ladder programs in **1 ms** (See note.) **Fast**

Note: Basic instructions only

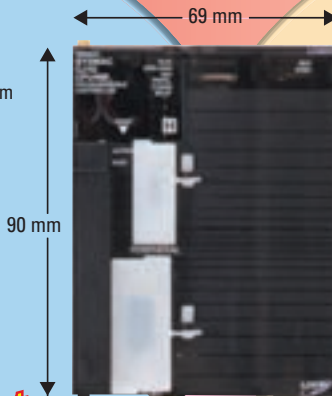

Loop-control CPU Unit

D: 65 mm

Loop Control Engine

Loop Controller Element:

Up to **300** or **50** function blocks
CX-Process loop control program (function blocks)



Execute PID Control for **20 Loops** in **10 ms** (See note.) **Fast**

Note: General application (e.g., loop configuration: Ai4 Terminal + Segment Linearizer + Basic PID + Ao4 Terminal)

Downsizing

Small Super compact: Only 90 mm High and 65 mm Deep, and Backplane-free structure enables flexible width design.



Compact PLC Aids Machine Downsizing by Fitting Just About Anywhere. Wide Array of I/O Units, Special I/O Units, and CPU Bus Units Are Available to Suit Your Application.

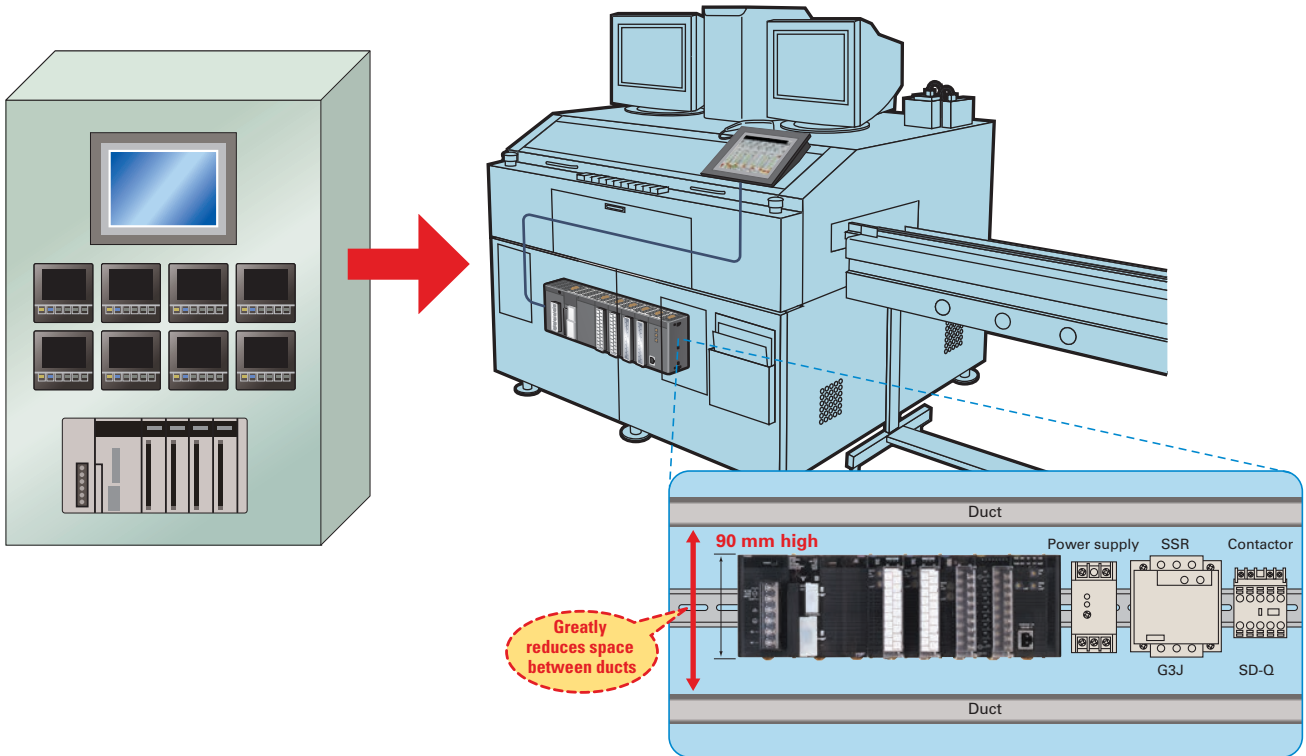

Fast High-speed sequence control functions can be used directly for high-speed, advanced loop control.



- **Sequence control:** Executes 20-Kstep ladder programs in 1 ms (with basic instructions only). PCMIX = 7.4 LD or OUT executed in 40 ns
- **Loop control:** Executes PID operations for 20 loops in up to 10 ms. This is a guide for general applications. (See note.)

● Sequencing

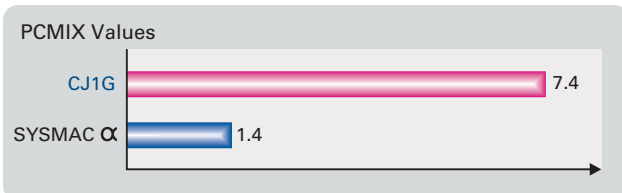

Note: Loop configuration: Ai4 Terminal + Segment Linearizer + Basic PID + Ao4 Terminal
The external I/O response time in the overall system refers to the conversion time.

Dedicated microcomputer board

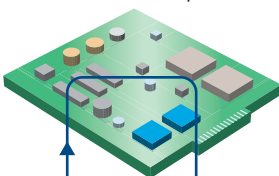

High-speed processing
(Example: 1-ms response)

CJ-series PLC

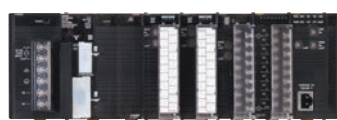

The same level of high-speed processing

Only One CPU Unit Needed

Digital Controller



High-speed processing
(Example: 50 ms)

Easy Engineering

Easy

Function blocks make loop-control programming easy. You can also create CX-Process Tool tuning windows to help adjust loops. Controller faceplates can be created automatically for touch panel displays.



- **Sequence control programs:** Standardize and simplify programs using structured programming. Special I/O Unit and CPU Bus Unit settings are easy with function blocks (using ladder programming language or structured text).
- **Loop control programs:** By combining function blocks, a wide array of control methods can be easily configured, from basic PID control used by Temperature Controllers to program, cascade, and feed-forward control. Easily display values, such as temperatures, in engineering units, allowing you to check operation.

● Engineering Example: Program Control

Loop-control CPU Unit

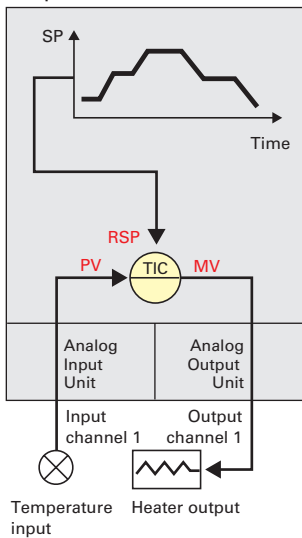

CX-Process Tool (Software for Personal Computer)

- Combine function blocks and connect graphically using the mouse.

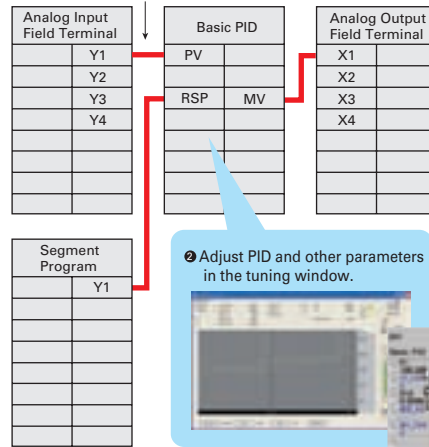

- Adjust PID and other parameters in the tuning window.

Face Plate Auto-Builder for NS

- Touch panel windows are automatically generated.

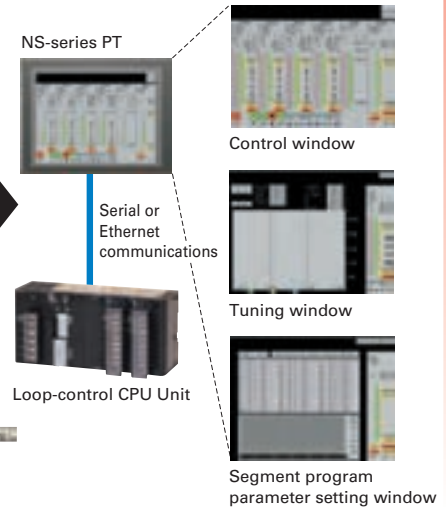

Expandability

Lineup includes low-cost models that use up to 50 function blocks and models that allow up to 300 blocks designed for large-scale systems and complicated operations.



- **Loop control:** Programming with function blocks to suit the application.
- **System configuration:** Choose and combine functions from a broad selection of I/O Units.

Process Input Units, Analog I/O Units, etc.

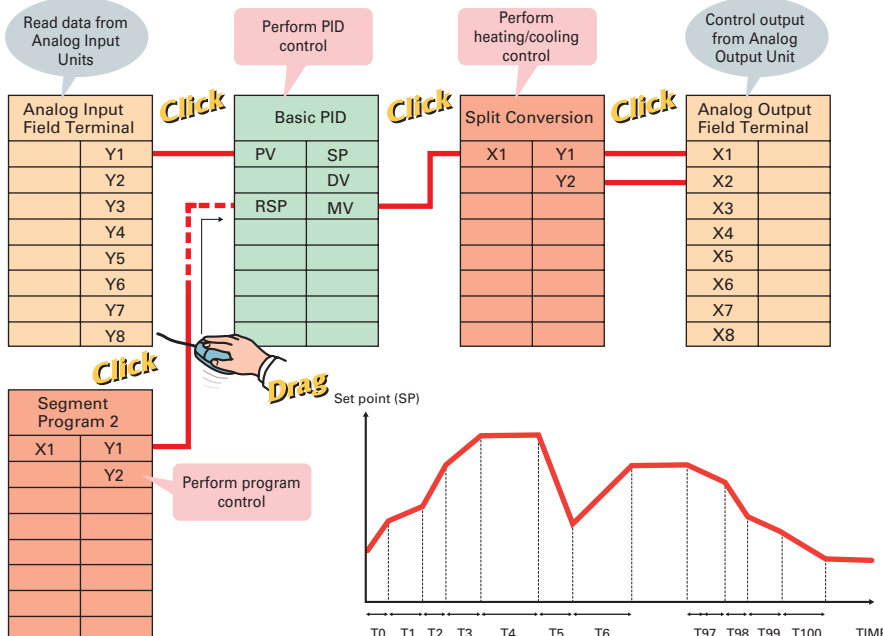

● System Configuration

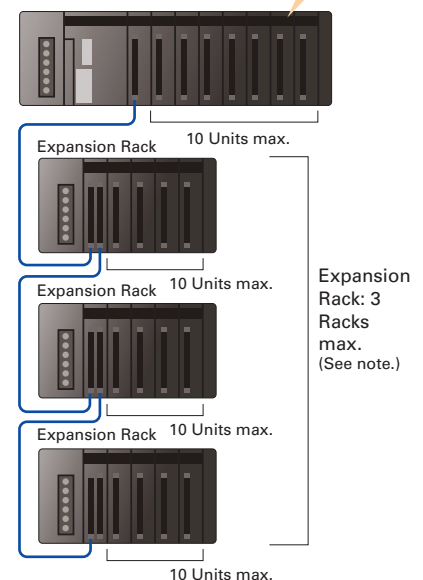

Note: CJ1G-CPU44P/45P (CJ1G-CPU42P/43P: Expand up to 2 Racks)

High Reliability

Maintenance

Simply turn the DIP Switch ON/OFF to save or read the user program including function blocks using the Memory Card.



- Simple backup function enables backup, recovery, and comparison of all PLC data including the function block programs for the Loop Control Board using the Memory Card.
- Save tag settings, comments, annotations, and connection data created using the CX-Process Tool to either a Memory Card or a Loop-control CPU Unit. **Note:** Supported by unit version 3.0 or later.

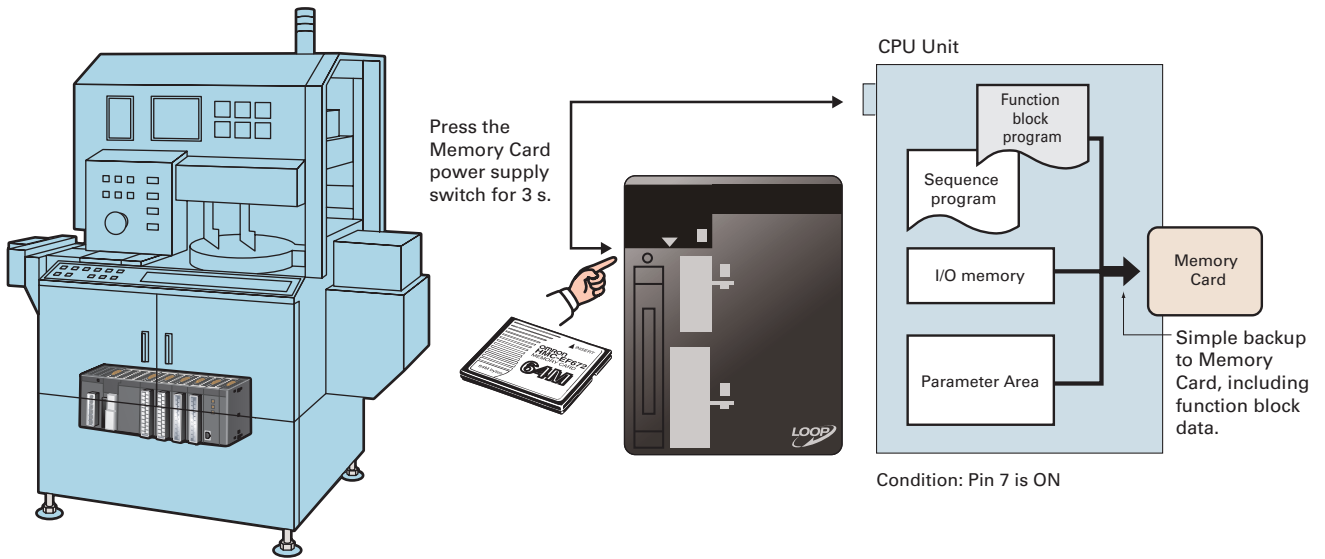

Results

Consolidating OMRON's expertise in temperature and process control cultivated over many years to provide you with effortless solutions using proven algorithms.



- **Loop control:** Proven functionality of Temperature Controllers and CS-series Loop Control Boards (see note 1) in a compact size.

New Algorithm Further Enhances Control Stability Disturbance Overshoot Adjustment

This function restrains overshoot when a disturbance is generated, allowing faster stabilization.

[Example]

- Temperature drops when adding objects to a furnace
- Control disturbances when retooling

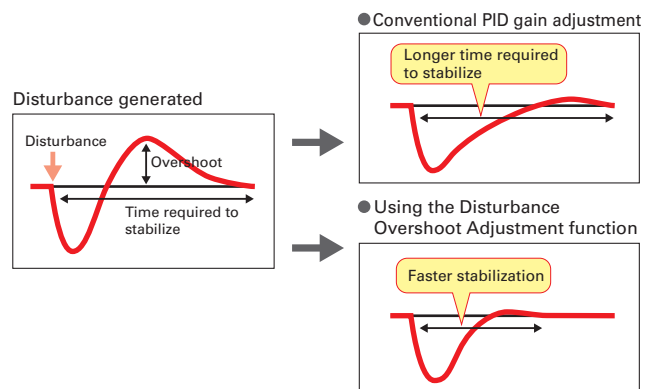

Optimum Tuning to Suit the Application Fine Tuning

Adjust PVs, SPs, and MVs while monitoring, and save data as CSV files from the software tuning window. Autotuning (AT) and fine-tuning functions can also be used for automatically calculating PID constants (see note 2).

- Note 1:** For details on CS-series Loop Control Boards, refer to the PLC-based Process Control Catalog (Cat. No. P051).
Note 2: Control can be fine-tuned by automatically tuning PID parameters using previous control parameters and three user-set requirements to execute fuzzy logic.



CS-Process Tool Tuning Window

Applications

The Loop-control CPU Unit Provides You with Solutions for the Complex and Advanced Functions Demanded by Control Devices in an Increasingly Diverse Range of Equipment.

● Sterilization and Disinfection of Pharmaceuticals, Food and Beverages

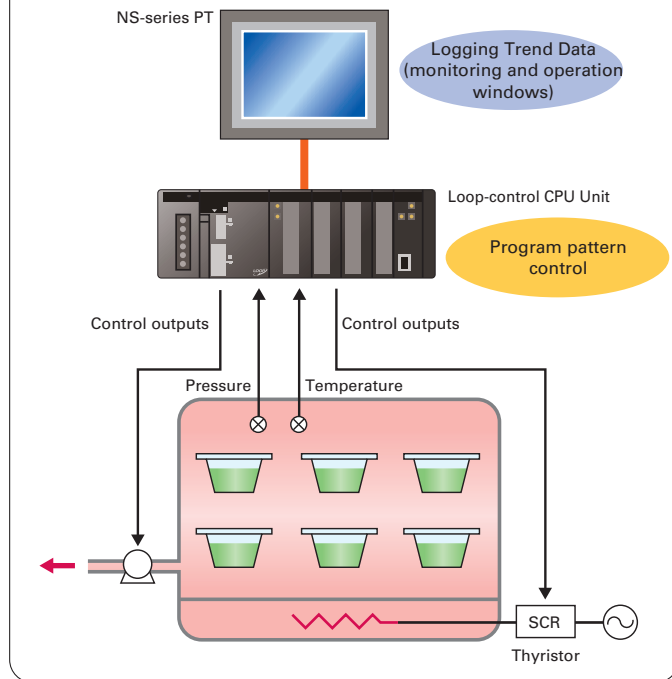

● Industrial Furnace

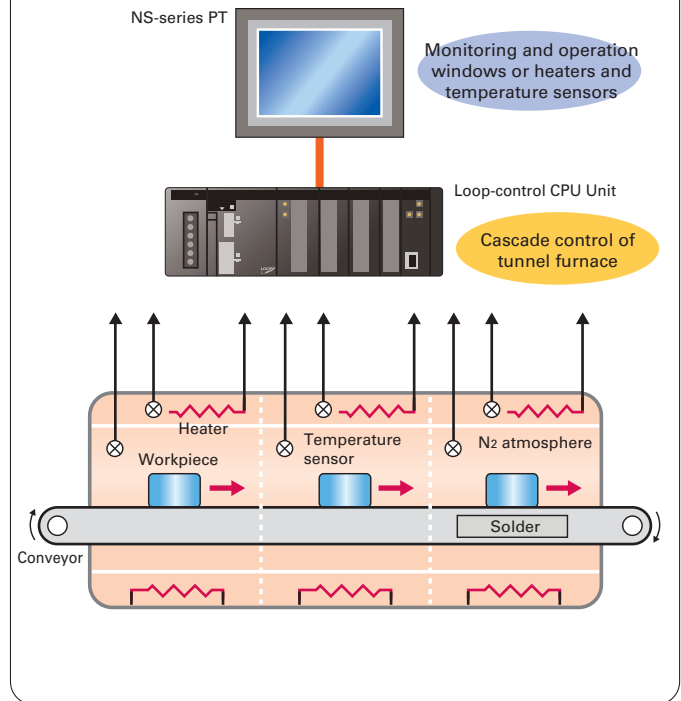

● Gradient Temperature Control for Planar Temperature Control Across Multiple Points

Note: CJ1G-CPU45P-GTC only.

Gradient temperature control equalizes the temperatures at multiple points, providing high-quality heat processing, reducing energy loss until temperatures stabilize, and saving labor in adjustments due to interference between heaters.

For details, refer to the *SYSMAC CS/CJ Series Controllers for Gradient Temperature Control Catalog (R141)*.

Example: Planar Temperature Control of Multi-stage Furnaces, Wafer and Glass Surface Temperatures, and Other Applications.

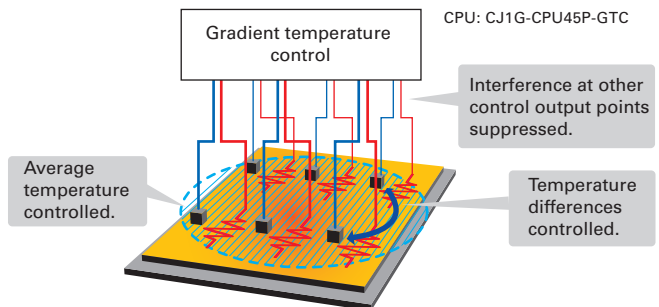

Providing Solutions to Other Problems

Electrical parts equipment requiring high-speed temperature control for higher precision and improved tact time.

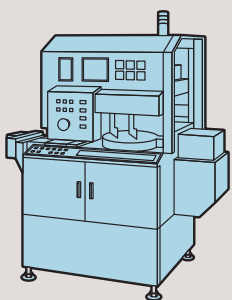

Diffusion furnaces that perform cascade control of heater temperatures and internal chamber temperatures.

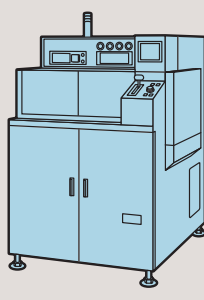

Food machines, semi-conductor devices and other machines requiring **multipoint temperature control**.

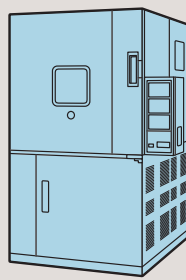

Fermentation equipment requiring temperature, pressure, flowrate, and pH control.

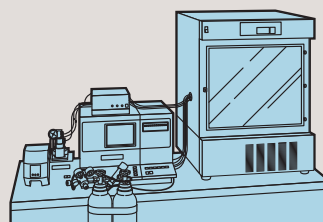

Testing devices that frequently change setting conditions and program settings.

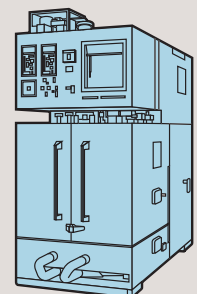

Loop Control Machines and Product Variations

Model Selection

Compact CJ-series Loop-control CPU units are ideal for equipment with built-in applications. CS-series and CS1D models designed for duplex systems are also available for processing equipment that requires high reliability.

Processing facilities

- Chemical/ pharmaceutical
- Utilities
- DCS replacement
- Water treatment
- Etc.

Machinery

- Semi-conductor/ electrical components
- Industrial furnaces (firing)
- Food machines (sterilization)
- Testing equipment
- Etc.

• Packaging machines

• General food machines

Easy

Controlling analog quantities

High-speed and highly reliable (duplex)

Note 1: The Temperature Control Unit integrates control and I/O for either 2 loops or 4 loops. Temperature control is achieved simply by setting parameters. (CX-Process cannot be used.)
Note 2: For details on CS-series Loop Control Boards and Process-control CPU Units, refer to the PLC-based Process Control Catalog (Cat. No. P051).

System Configuration Example

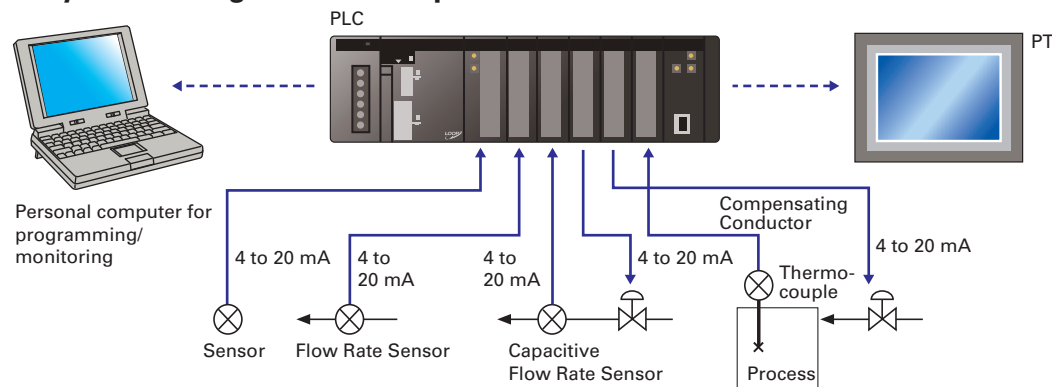

Example of Peripheral Devices

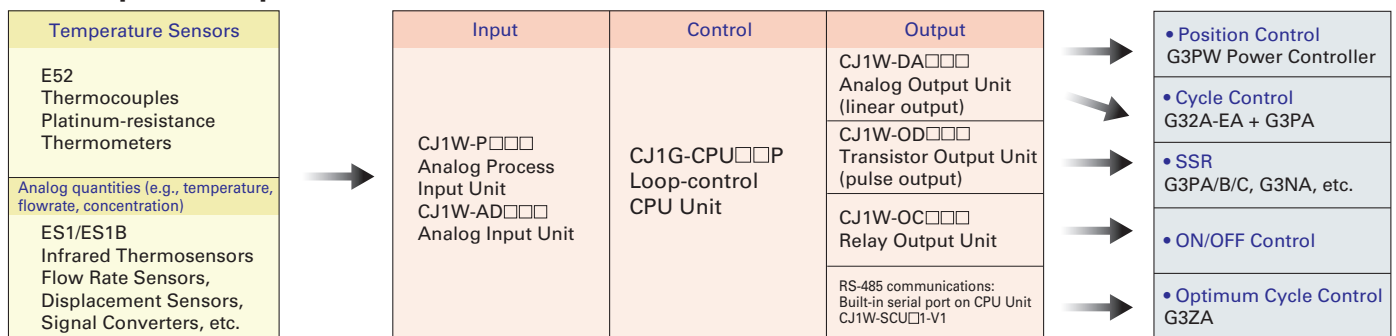

SYSMAC CJ Series

Peripheral Devices

Input Devices

▶ E52-series Temperature Controllers

Plenty of Variation to Suit an Extensive Range of Applications

- Select from a variety of choices in number of elements, shape, protective tubing length, and terminal type.
- Economical models and special models are available as well as general-purpose models. Select from a diverse range of models to suit the application: Models for high temperatures, metal patterns, surface measurement, and room temperatures, waterproof and anti-corrosive models, models for moving parts, and models with double elements.

■ Model Structure

E52-①②③ D=④ ⑤M ① Element type ④ Protective tubing model
② Protective tubing length ⑤ Lead wire length
③ Terminal type

Example: **E52-CA15A D:3.2 2M**



▶ ES1/ES1B-series Infrared Thermosensors

Hygienic temperature measurement without damaging the workpiece. Ideal for workpieces on conveyors or other applications in which contact measurement is difficult.

- ES1 Series: Designed for high-precision, small-spot, high-temperature measurements.
- Two types of small spot: 3-mm dia. and 8-mm dia.
- High-precision and high-speed measurement with a repeatability of ± 0.5 C and response speed of 0.4 s (95%).
- Models are available for medium (-500 to 500 C), mid-low (-50 to 500 C), and high (0 to 1000 C) temperature ranges.



Output Devices

▶ G3PF Solid-state Relay with Built-in Current Transformer (CT)

Built-in current transformer is provided and heater burnouts and SSR short-circuits can be detected.

- Built-in current transformer reduces wiring work.
- Detects the burnout of any one of multiple heaters.
- Detects burnouts in 3-phase heaters.
- Detects SSR short-circuits.
- Error detection level can be easily set with a switch.
- Can be mounted to a DIN Track or with screws.
- Three types of input terminals are available: M3 terminals, screwless clamp terminals (detachable), or compact slotted terminals (detachable).



▶ G3ZA Multi-channel Power Controller

Optimum Cycle Control for High-precision Control with Low Noise

- Smaller than power conditioners.
- Power control with little noise is enabled by combining the Power Controller with zero-cross SSRs. (See note.)
- One Controller can control up to 8 SSRs.
- RS-485 communications can be used to set output values and heater burnout detection.
- The G3ZA Smart FB Library is also available.
- A soft-start function that can be used for lamp heaters has been added. (See note.)
- A 3-phase optimum cycle control function has been added for use with 3-cycle heaters.
- Detection of 150-A currents has been added along with a special current transformer.

Note: Non-zero-cross SSRs must be used in combination with the soft-start function.



New Products

▶ **CJ1W-PH41U Process Analog I/O Unit (High-resolution Unit with Fully Universal Inputs)**

CJ1W-AD04U Process Analog I/O Unit (General-purpose Unit with Fully Universal Inputs)

A single Unit handles all types of inputs, including temperature sensor inputs (e.g., thermocouple or platinum resistance thermometer), analog signal inputs (e.g., 4 to 20 mA or 1 to 5 V), and potentiometer inputs.

● **Fully Universal Inputs, Including Thermocouple Inputs, Platinum Resistance Thermometer Inputs, and DC/Voltage Inputs**

The input type can be selected for each input channel, saving space and reducing costs for compact devices that use a mix of input types. And trouble-free selection of input types improves inventory control and maintenance.

● **General-purpose Models for Great Cost Performance and High-resolution Models for Applications Such as Semiconductor Production Equipment**

These compact CJ-series Units provide four isolated input channels per Unit. Depending on the application, choose either the high-resolution CJ1W-PH41U, which provides a selection of combinations of resolutions and conversion speeds in addition to a PLC-first 1/1,000 C range (0.000 to 50.000 C, 4-wire Pt100), or the general-purpose CJ1W-AD04U, which provides superior cost performance. (See note.)

Note: According to OMRON investigation.



Resolutions and Sampling Speeds for High-resolution Models

Resolution: 1/256,000	Resolution: 1/64,000	Resolution: 1/16,000
60 ms/4 points	10 ms/4 points	5 ms/4 points

Loop-control CPU Units

Loop-control CPU Units

Model	CPU Unit element				Loop Controller	
	I/O capacity	Program capacity	Data memory capacity	Programming software	Number of function blocks	Programming software
CJ1G-CPU45P	1,280 points (Up to 3 Expansion Racks)	60 Ksteps	128 K words (DM: 32 K words, EM: 32 K words × 3 banks)	CX-Programmer, CX-Simulator, etc.	300 blocks	CX-Process
CJ1G-CPU45P-GTC		30 Ksteps				
CJ1G-CPU44P		20 Ksteps				
CJ1G-CPU43P	960 points (Up to 2 Expansion Racks)	10 Ksteps			50 blocks	
CJ1G-CPU42P						

Loop Controller Element Specifications

Item	Specification	
Name	Loop-control CPU Unit	
Model Number	CJ1G-CPU□□P(-GTC)	
Applicable PLCs	CJ-series PLCs	
Area for data exchange with CPU Unit	CPU Unit's Auxiliary Area <ul style="list-style-type: none"> Loop Controller element-to-CPU Unit element: Run Status Flag, PV Error Input Flag, MV Error Input Flag, Execution Error Flag, Function Block Database (RAM) Error Flag, Automatic Cold Start Execution Flag, Backup during Operation Flag, Function Block Changed Flag, etc. CPU Unit element-to-Loop Controller element: Start Mode at Power ON: Hot/Cold Start bit. 	
	User allocations in I/O Memory	User link tables are used to allocate function block ITEM data in any part of I/O memory in the CPU Unit. (CIO, Work, Holding, or DM Areas, or EM Area bank 0)
	Allocations for all data	HMI function used to allocate function block ITEM data for Control, Operation, External Controller, and System Common blocks in the specified bank of the EM Area in the CPU Unit.
Settings	None	
Indicators	Two LED indicators: RUN and ready	
Super capacitor backup data	All function block data (including sequence tables, step ladder program commands), stored error log data	
Super capacitor backup time	5 minutes at 25°C	
Data stored in flash memory	Function block data	
Backup from RAM to flash memory	Executed from CX-Process Tool (as required).	
Recovery from flash memory to RAM	Automatically transferred when power to CPU Unit is turned ON if startup mode is set for a cold start, or executed from CX-Process Tool (as required).	
Influence on CPU Unit cycle time	0.8 ms max. (depends on function block data contents)	
Current consumption (supplied from Power Supply Unit)	1.06 A for 5 VDC (current consumption for Loop-control CPU Unit including CPU Unit element and Loop Controller element) Note: Increased by 150 mA when NT-AL001 Link Adapter is used.	

Loop Controller Element Specifications

Item			Specifications																		
Model			CJ1G-CPU42P	CJ1G-CPU43/44/45P(-GTC)																	
Operation method			Function block method																		
Loop Controller element			LCB01	LCB03																	
Function block analog operations	Control and operation blocks	PID and other control functions, square root operation, time operations, pulse train operation, and other operation functions for various processes.	50 blocks max.	300 blocks max.																	
Sequence control	Step ladder program blocks	Logic sequence and step sequence functions	20 blocks max. 2,000 commands total 100 commands max. per block Separable into 100 steps max.	200 blocks max. 4,000 commands total 100 commands max. per block Separable into 100 steps max.																	
I/O blocks	Field terminal blocks	Analog I/O function with Analog I/O Unit, contact I/O function with Basic I/O Unit	30 blocks max.	CJ1G-CPU43P: 30 blocks max. CJ1G-CPU44/45P: 40 blocks max.																	
	User link tables	Analog data I/O and contact data I/O function for CPU Unit	2,400 data items max.																		
	HMI function	I/O function for the specified bank of the EM Area in the CPU Unit for function block ITEM data used for Control, Operation, External Controller, and System Common blocks for the HMI function.	Allocated 1 EM Area bank Operation and Control blocks: 50 blocks max. × 20 send/receive words System Common blocks: 20 send/receive words	Allocated 1 EM Area bank Operation and Control blocks: 300 blocks max. × 20 send/receive words System Common blocks: 20 send/receive words																	
	System Common block	System common operation cycle setting, run/stop command, load rate monitor, etc.	Single block																		
Method for creating and transferring function blocks			Created using CX-Process Tool (purchased separately) and transferred to Loop Controller.																		
External I/O response time			The time from external input of analog signals up to external output of analog signals on a single control loop depends on the function block's operation cycle and the CPU Unit's cycle time.																		
Operation cycle			0.01, 0.02, 0.05, 0.1, 0.2, 0.5, 1, or 2 s (default: 1 s) (See note.) Can be set for each function block. Note: 0.01, 0.02, and 0.05 s cannot be set for some blocks.																		
Internal operation	Number of control loops		<ul style="list-style-type: none"> The maximum number of loops that can be used if the LCB load rate is 80% for a standard applications (e.g., with each loop consisting of one Ai4 Terminal, Segment Linearizer, Basic PID, and A04 terminal) is shown in the following table. <table border="1" style="margin-left: 20px;"> <thead> <tr> <th>Operation cycle</th> <th>Maximum number of loops</th> <th>Operation cycle</th> <th>Maximum number of loops</th> </tr> </thead> <tbody> <tr> <td>0.01 s</td> <td>20 loops</td> <td>0.2 s</td> <td rowspan="4">150 loops (See note.)</td> </tr> <tr> <td>0.02 s</td> <td>35 loops (see note)</td> <td>0.5 s</td> </tr> <tr> <td>0.05 s</td> <td>70 loops (see note)</td> <td>1 s</td> </tr> <tr> <td>0.1 s</td> <td>100 loops (see note)</td> <td>2 s</td> </tr> </tbody> </table> <p>Note: Loop Controller element LCB01: 25 loops max.</p>		Operation cycle	Maximum number of loops	Operation cycle	Maximum number of loops	0.01 s	20 loops	0.2 s	150 loops (See note.)	0.02 s	35 loops (see note)	0.5 s	0.05 s	70 loops (see note)	1 s	0.1 s	100 loops (see note)	2 s
Operation cycle	Maximum number of loops	Operation cycle	Maximum number of loops																		
0.01 s	20 loops	0.2 s	150 loops (See note.)																		
0.02 s	35 loops (see note)	0.5 s																			
0.05 s	70 loops (see note)	1 s																			
0.1 s	100 loops (see note)	2 s																			
Control method	PID control method		PID with 2 degrees of freedom																		
	Control combinations		Any of the following function blocks can be combined: Basic PID control, cascade control, feed-forward control, sample PI control, Smith dead time compensation control, PID control with differential gap, override control, program control, time-proportional control, etc.																		
Alarms	PID block internal alarms		4 PV alarms (upper upper-limit, upper limit, lower limit, lower lower-limit) and 1 deviation alarm per PID block																		
	Alarm blocks		High/low alarm blocks, deviation alarm blocks																		

List of Function Blocks

System Common Block

Type	Block Name	Function
---	System Common	Makes settings common to all function blocks and outputs signals for the system.

Operation Blocks

Type	Block Name	Function	
Alarm/Signal restrictions/ Hold	High/Low Alarm (See note 1.)	Provides the alarm contact outputs for the high and low limits of single analog signals.	
	Deviation Alarm (See note 1.)	Provides the alarm contact outputs for the deviation of two analog signals.	
	Rate-of-change Operation and Alarm (See note 1.)	Provides the alarm contact outputs for the high and low limits of rate-of-change operation when the analog signal rate-of-change is output.	
	High/Low Limit (See note 1.)	Limits the high and low limits of single analog signals.	
	Deviation Limit (See note 1.)	Calculates the deviation between two analog signals, and limits the deviation within that range.	
Arithmetic	Analog Signal Hold (See note 1.)	Holds the maximum, minimum or instantaneous value of single analog signals.	
	Addition or Subtraction (See note 1.)	Performs addition/subtraction with gain and bias on up to 4 analog signals.	
	Multiplication (See note 1.)	Performs multiplication with gain and bias on up to 2 analog signals.	
	Division (See note 1.)	Performs division with gain and bias on up to 2 analog signals.	
	Arithmetic Operation (See note 1.)	Performs various math operation (trigonometric, logarithmic, etc.) on floating-point decimal values converted (to industrial units) from up to 8 analog inputs.	
Functions	Range Conversion (See note 1.)	Easily converts up to 8 analog signals simply by inputting the 0% and 100% input values and 0% and 100% output values.	
	Square Root (See note 1.)	Performs square root extraction (with low end cutout) on single analog signals.	
	Absolute Value (See note 1.)	Outputs the absolute value of single analog signals.	
	Non-linear Gain (Dead Band) (See note 1.)	Performs non-linear (3 gain values) operation on single analog signals. Analog signals can also set as a dead band (with different gap).	
	Low-end Cutout (See note 1.)	Sets output to zero close to the zero point of single analog signals.	
	Segment Linearizer (See note 1.)	Converts single analog signals to 15 segments before the signals are output.	
	Temperature and Pressure Correction (See note 1.)	Performs temperature and pressure correction.	
	Time Function	First-order Lag (See note 1.)	Performs first-order lag operation on single analog signals.
		Rate-of-change Limit (See note 1.)	Performs rate-of-change restriction on single analog signals.
		Moving Average (See note 1.)	Performs moving average operation on single analog signals.
Lead/Delay (See note 1.)		Performs lead/delay operation on single analog signals.	
Dead Time (See note 1.)		Performs dead time and first-order lag operations on single analog signals.	
Dead Time Compensation		Used for Smith's dead time compensation PID control.	
Accumulator for instantaneous value input		Accumulates analog signals, and outputs 8-digit accumulated value signals.	
Run Time Accumulator		Accumulates the operating time, and outputs the pulse signal per specified time.	
Time Sequence Data Statistics (See note 1.)		Records time sequence data from analog signals and calculates statistics, such as averages and standard deviations.	
Ramp Program		Ramp program setter for combining ramps for time and hold values.	
Segment Program		Segment program setter setting the output values with respect to time.	
Segment Program 2		Segment program setting with wait function for setting the output values with respect to time.	
Segment Program 3			

Control Blocks

Type	Block Name	Function
Controller	2-position ON/OFF (See note 1.)	2-position type ON/OFF controller
	3-position ON/OFF (See note 1.)	3-position type ON/OFF controller for heating/cooling ON/OFF control
	Basic PID (See note 1.)	Performs basic PID control.
	Advanced PID (See note 1.)	Performs advanced PID control for enabling deviation/MV compensation, MV tracking, etc.
	Blended PID (See note 2.)	Performs PID control on the cumulative value (cumulative deviation) between the accumulated value PV and accumulated value Remote Set Point.
	Batch Flowrate Capture (See note 2.)	Functions to open the valve at a fixed opening until a fixed batch accumulated value is reached.
	Fuzzy Logic (See note 2.)	Outputs up to 2 analog outputs based on fuzzy logic performed on up to 8 analog inputs.
	Indication and Setting (See note 1.)	Manual setter with PV indication and SP setting functions
	Indication and Operation (See note 1.)	Manual setter with PV indication and MV setting functions
	Ratio Setting (See note 1.)	Ratio and bias setter with PV indication and ratio setting function
Indicator (See note 1.)	PV indicator with PV alarm	

- Note:**
1. The Function Blocks dealing with high-speed operation (operation cycle: 0.01, 0.02, and 0.05 seconds is possible).
 2. Cannot be used with the CJ1G-CPU45P-GTC.

List of Function Blocks

Type	Block Name	Function
Signal Selection/Switching	Rank Selector (See note 1.)	Selects the rank of up to 8 analog signals.
	Input Selector (See note 1.)	Selects the specified analog signals specified by the contact signal from up to 8 analog signals.
	3-input Selector (See note 1.)	Selects and outputs one of three analog input signals.
	3-output Selector (See note 1.)	Outputs one analog input signal in three switched directions.
	Constant Selector (See note 1.)	Selects 8 preset constants by the contact signal.
	Constant Generator (See note 1.)	Outputs 8 independent constants.
	Ramped Switch	Switches two analog inputs (or constants) with a ramp.
	Bank Selector	Records the PID parameters (SP, P, I, D, MH, ML) in up to 8 sets in advance, and switches the PID parameter for Basic/Advanced/Blended PID Blocks according to the analog input range (zone) or input bits.
Split Converter	Inputs the MV from the Basic PID block or Advanced PID block, converts the MV into two analog outputs for V characteristics or parallel characteristics (e.g., MV for heating or cooling) and outputs them.	
Constant ITEM Setting	Constant ITEM Setting (See note 1.)	Writes the constant to the specified ITEM at the rising edge of the send command contact.
	Variable ITEM Setting (See note 1.)	Writes the analog signal to the specified ITEM at the rising edge of the send command contact.
	Batch Data Collector (See note 1.)	Stores each of max. 8 analog inputs to buffer by a certain timing within sequential processing.
Pulse Train Operation	Accumulated Value Input Adder	Adds up to four accumulated value signals.
	Accumulated Value Analog Multiplier	Multiplies analog signals by the accumulated value signals.
	Accumulator for accumulated value input	Converts 4-digit accumulated value signals to 8 digits.
	Contact input/Accumulated value output	Counts low-speed contact pulses, and outputs 8-digit accumulated signals.
	Accumulated Value Input/Contact Output	Converts 4-digit accumulated value signals to low-speed contact pulses before they are output.
Others	Analog/Pulse Width Converter (See note 1.)	Changes the ON/OFF duration ratio in a constant cycle duration so that it is proportional to the analog signal.
Sequence Operation	Contact Distributor	Connect contact signals between function blocks in a 1:1 connection.
	Constant Comparator (See note 1.)	Compares up to eight sets of analog signals and constants, and outputs the comparison results as contacts.
	Variable Comparator (See note 1.)	Compares up to eight pairs of analog signals, and outputs the comparison results as contacts.
	Timer (See note 1.)	2-stage output type addition timer for forecast values and reached values. Can also output the present value.
	ON/OFF Timer (See note 1.)	Timer for performing ON-OFF operation at preset ON and OFF times.
	Clock Pulse (See note 1.)	Outputs a clock pulse at the setting time interval for a single operation cycle.
	Counter (See note 1.)	2-stage output type addition timer for forecast values and arrival values. Can also output the current value.
	Internal Switch (See note 1.)	Temporary storage contact for accepting relays in the Step Ladder Program block. Note: (One internal switch is already allocated as "temporary storage" in CX-Process Tool.)
	Level Check (See note 1.)	Checks an analog input for 8 levels and outputs a contact corresponding to the level. The level number is also output as an analog value at the same time.
	Contact Type Control Target	ON/OFF Valve Manipulator
Motor Manipulator		Manipulates and monitors motor operation.
Reversible Motor Manipulator		Manipulates and monitors reversible motor operation.
Motor Opening Manipulator		Inputs a target opening, and manipulates an electric positional-proportional motor.
Switch Meter (See note 2.)		Manipulates and monitors multiple (up to 8) devices such as ON/OFF valves, motors, or pumps.

- Note:** 1. The Function Blocks dealing with high-speed operation (operation cycle: 0.01, 0.02, and 0.05 seconds is possible).
2. Cannot be used with the CJ1G-CPU45P-GTC.

Sequence Control

Type	Block Name	Function
---	Step Ladder Program (See note.)	Performs logic sequence and step progression control.

Note: The Function Blocks dealing with high-speed operation (operation cycle: 0.01, 0.02, and 0.05 seconds is possible).

Field Terminals

Type	Block Name	Function
Contact I/O (See note.)	DI 8-point Terminal	Inputs 8 contacts from 8-point Input Unit.
	DI 16-point Terminal	Inputs 16 contacts from 16-point Input Unit.
	DI 32-point Terminal	Inputs 32 contacts from 32-point Input Unit.
	DI 64-point Terminal	Inputs 64 contacts from 64-point Input Unit.
	DO 8-point Terminal	Outputs 8 contacts from 8-point Output Unit.
	DO 16-point Terminal	Outputs 16 contacts from 16-point Output Unit.
	DO 32-point Terminal	Outputs 32 contacts from 32-point Output Unit.
	DO 64-point Terminal	Outputs 64 contacts from 64-point Output Unit.
	DI 16-point/DO 16-point Terminal	Inputs and outputs 16 contacts each from 16-point Input/16-point Output Units.
	Analog I/O (See note.)	AI 4-point Terminal (PTS51)
AI 4-point Terminal (PTS52)		Inputs 4 analog signals from CJ1W-PTS52 (Isolated-type Temperature Resistance Input Unit).
AI 2-point Terminal (PTS15/16, PDC15)		Inputs 2 analog signals from CJ1W-PTS15/16, PDC15 (Isolated-type DC Input Unit).
AI 8-point Terminal (AD081)		Inputs 8 analog signals from the CJ1W-AD081(-V1).
AO 8-point Terminal (DA08V/C)		Outputs 8 analog signals from the CJ1W-DA08V/DA08C.
AI 4-point Terminal (AD041)		Inputs 4 analog signals from the CJ1W-AD041(-V1).
AO 4-point Terminal (DA041)		Outputs 4 analog signals from the CJ1W-DA041(-V1).
AO 2-point Terminal (DA021)		Outputs 4 analog signals from the CJ1W-DA021.
AI 4-point/AO 2-point Terminal (MAD42)		Inputs 4 analog signals and outputs 2 analog signals each from the CJ1W-MAD42.
AI 4-point Terminal (DRT1-AD04)		Inputs 4 analog signals from a DRT1-AD04 DeviceNet Slave Analog Input Unit.
AO 2-point Terminal (DRT1-DA02)	Outputs two analog signals from a DRT1-DA02 DeviceNet Slave Analog Output Unit.	
AI 4-point Terminal (AD04U)	Inputs 4 analog signals from the CJ1W-AD04U.	
AI 4-point Terminal (PH41U)	Inputs 4 analog signals from the CJ1W-PH41U.	

Note: The Function Blocks dealing with high-speed operation (operation cycle: 0.01, 0.02, and 0.05 seconds is possible).

CX-Process Tool and Monitor

Software Specifications

Item		Specifications
		CX-Process Tool
Name		CX-Process
Model number		(Included in CX-One Package)
Applicable PLCs		CS-series PLCs CJ-series PLCs
Applicable Units		CJ-series Loop-control CPU Units CS-series Loop Control Units/Boards CS1D Process-control CPU Units
Compatible computers	CPU	Processor recommended by Microsoft.
	OS	Windows 7 (32-bit/64-bit version) / 8 (32-bit/64-bit version) / 8.1 (32-bit/64-bit version) / 10 (32-bit/64-bit version)
	Memory	Memory recommended by Microsoft.
	Hard disk	Approx. 4.0 GB or more of available memory is required to install all of the CX-One.
	Display	XGA (1,024 × 768), High Color (16-bit) or higher
	Disk drive	DVD-ROM drive
Communications method	Connection with CPU Unit (or Serial Communications Board/Unit)	When FinsGateway Serial Unit driver is used: Communications protocol with PLC: Host Link or Peripheral Bus (See note 2.) • Connect the computer to the peripheral port or built-in RS-232C port of the CPU Unit, or to the RS-232C port of the Serial Communications Board/Unit. • Connecting cable: For connecting to peripheral port of CPU Unit: CS1W-CN□□□□ (2 m or 6 m) For connecting to RS-232C port of CPU Unit: XW2Z-□□□□-□ (2 m or 5 m)
		When CX-Server is used: Communications protocol with PLC: Host Link or Peripheral Bus Connecting Cable: • For connecting to peripheral port of CPU Unit: CS1W-CN□□□□ (2 m or 6 m) For connecting to RS-232C port of CPU Unit: XW2Z-□□□□-□ (2 m or 5 m)
	Connection via Controller Link	When FinsGateway Controller Link driver or CX-Server is used: Install the software in a computer with a Controller Link Support Board to communicate with a PLC with a Controller Link Unit mounted.
	Connection via Ethernet	When FinsGateway ETN_UNIT driver or CX-Server is used: Install the software in a computer with an Ethernet Board to communicate with a PLC with an Ethernet Unit mounted.

Item	Specifications	
Offline functions	ITEM data settings for function blocks <ul style="list-style-type: none"> • Software connections for analog signals • Displaying and printing text strings (annotation) pasted on function block diagrams and ladder diagrams. • Instructions for step ladder blocks and commands for sequence table blocks • Tag settings for CX-Process Monitor • Engineering unit display setting • Segment Program parameter setting 	Construction of user screens
Online functions	<ul style="list-style-type: none"> • Transfer of function block data (Downloading/Uploading for Loop Control Boards/Units.) • Starting/stopping all function blocks (LCU/LCB) • Monitoring system operation: Monitoring and controlling the System Common block (including LCB/LCU load rates) • Validating LCB/LCU operation: Checking function block connections (including starting and starting individual function blocks), validating ladder diagrams and sequence tables, and monitoring ITEMS • Tuning PID constants and other parameters (fine tuning and autotuning) • Initialization of Loop Control Unit memory (RAM) • External backup specifications 	User screens <ul style="list-style-type: none"> • Overview screen • Control screen • Tuning screen • Trend screen • Graphic screen • Operating guide message screen System screens <ul style="list-style-type: none"> • Alarm history screen • System monitor screen • Operation log screen

Note: The CX-Process functions that can be used depend on the version. For details, refer to the *operation manuals* (Cat. No.: W372-E1-□ and W373-E1-□).

Note: Peripheral Bus cannot be used when FinsGateway V3 is used.

Connections to PLC

The following 4 methods can be used to connect to a PLC.

Communications network		Communication driver		
		FinsGateway V3	FinsGateway Version 2003 (See note 1.)	CX-Server
Host Link	Connection via PLC's peripheral port or RS-232C port	Supported. (Serial Unit version is used.)		Supported.
Peripheral Bus		Not supported.	Supported.	Supported.
Controller Link	Connection to PLC with Controller Link Unit via Controller Link Support Board (PCI board).	Supported. (See note 2.) (CLK (PCI) version is used.)		Supported.
	Connection to PLC with Controller Link Unit via Controller Link Support Board (ISA board).	Supported. (CLK (ISA) version is used.)		Supported.
Ethernet	Connection to PLC with Ethernet Unit via Ethernet Board.	Supported. (Ethernet version is used.)		Supported.

Note: 1. The Windows 2000 and XP operating systems are supported. (Windows 95, 98, and Me are not supported.)

2. The Windows 95 operating system cannot be used.

Utility Software

Touch Panel Software

■ Face Plate Auto-Builder for NS

Simply specify the CSV tag file created using the CX-Process Tool to automatically create a project constructed with a Face Plate for Loop-control CPU Units for use with OMRON's NS-series Programmable Terminals.

Function Overview

- Create windows for monitoring and tuning PID and other function blocks for up to 100 loops (NS System version 4 or higher).
- NS project files for monitoring multiple Loop-control CPU Units from a single NS-series PT can be generated from CX-Process projects for up to 32 multiple nodes.
- When a Segment Program 2 or 3 function block is used for program operation, the Detailed Setting Windows (Time Interval vs. Output Value Setting Window, Wait Interval Setting Window) used for the parameter settings are also automatically generated.
- NS-Runtime is supported.

Basic Specifications

Item	Specifications	
Name	Face Plate Auto-Builder for NS	
Model number	(Included in CX-One Package)	
Applicable PLC products	CJ-series Loop-control CPU Units CS-series Loop Control Boards (unit version 1.0 or later) CS-series Loop Control Units (unit version 2.0 or later) CS1D Process-control CPU Units	
Applicable PTs	NS-series NS12, NS10, and NS8 (PT version 2.0 or later), CX-Designer	
System requirements	Computer	IBM PC/AT or compatible
	CPU	Celeron 400 MHz or better recommended
	OS	Windows 7 (32-bit/64-bit version) / 8 (32-bit/64-bit version) / 8.1 (32-bit/64-bit version) / 10 (32-bit/64-bit version)
	Memory	Memory recommended by Microsoft.
	Hard disk	Approx. 4.0 GB or more of available memory is required to install all of the CX-One.
Disk drive	DVD-ROM drive	
Basic functions	Number of generated loops: 100 max., control windows and tuning windows Applicable face plates: 2-position ON/OFF, 3-position ON/OFF, Basic PID, Advanced PID, Indication and Operation, Indicator, Segment Program 2 (includes the parameter setting windows), Segment Program 3 (includes the parameter setting windows) Number of loops in control windows: 6 loops per window for NS12, 4 loops per window for NS10/NS8 Realtime trend in tuning window: 1-second cycle	

Example of Automatically Created Windows

The diagram illustrates three types of windows generated by the software:

- Basic PID Block Screen:** A vertical control panel for a PID loop. It includes fields for Tag No., Tag comment, and status display (AUTO, MAN, CAS). It features numerical displays for PV, SP, and MV, along with bar displays for PV and MV. Control buttons for CAS, SP, and MV are present, along with up/down arrows for adjusting SP and MV. Alarm status indicators and set value displays are also shown.
- Tuning Window:** A window for adjusting PID parameters. It includes sections for Alarm setting, Parameter settings, and a Realtime trend display showing a graph of the process variable over time. A 'To Control Window' button is visible.
- Segment program details setting window:** A window for configuring segment programs. It includes a table for 'Write/read setting data' with columns for 'Time interval, output value, and unit for each step'. A 'Setting confirmation graph (horizontal axis shows steps)' is also displayed.

Dimensions



Dimensions

CPU Units

■ Loop-control CPU Units

- CJ1G-CPU42P
- CJ1G-CPU43P
- CJ1G-CPU44P
- CJ1G-CPU45P(-GTC)

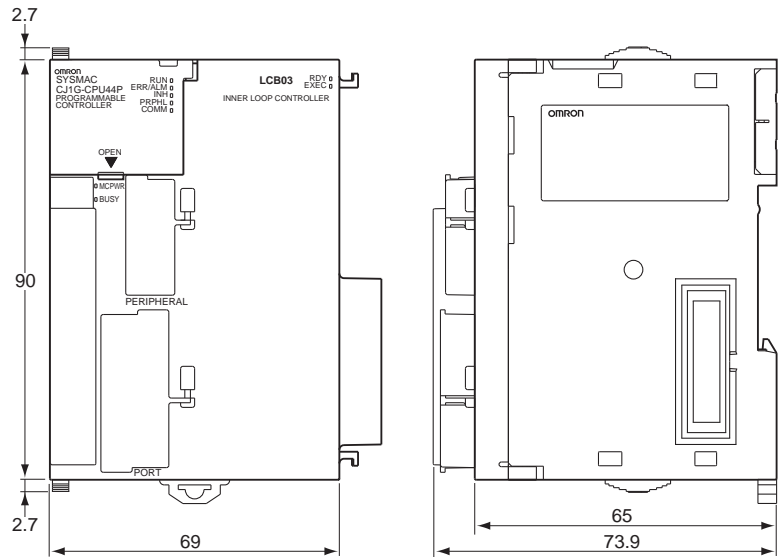

■ Process Input Units

- CJ1W-P□□□□

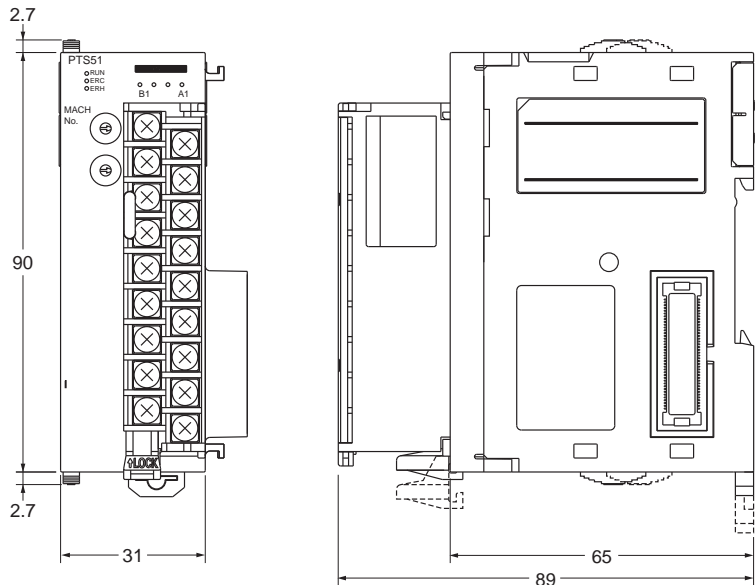

Ordering Information





Basic Configuration Units

■ CJ1 Loop Control Units

Product name	Specifications					Current consumption (A)		Model	Standards
	I/O capacity/ Mountable-Units (Expansion Racks)	Program capacity	Data memory capacity	LD instruction execution time	Loop Controller	5 V	24 V		
CJ1G Loop-control CPU Units 	1,280 points/ 40 Units (3 Expansion Racks max.)	60K steps	128K words (DM: 32K words, EM: 32K words × 3 banks)	0.04 μs	Number of function blocks: 300 blocks max.	1.06(See note 1.)	---	CJ1G-CPU45P	UC1, CE
		30K steps	64K words (DM: 32K words, EM: 32K words × 1 bank)			---	---	CJ1G-CPU45P-GTC	
	960 points/ 30 Units (2 Expansion Racks max.)	20K steps				---	---	CJ1G-CPU44P	
		10K steps				---	---	CJ1G-CPU43P	
				Number of function blocks: 50 blocks max.	1.06(See note 1.)	---	CJ1G-CPU42P		

■ Power Supply Units

One Power Supply Unit is required for each Rack.

Product name	Power supply voltage	Output capacity			Options			Model	Standards	
		5-VDC output capacity	24-VDC output capacity	Total power consumption	24-VDC service power supply	RUN output	Maintenance forecast monitor			
AC Power Supply Units   	100 to 240 VAC	5 A	0.8 A	25 W	No	No	Yes	CJ1W-PA205C	UC1, N, L, CE	
						Yes	No			CJ1W-PA205R
		2.8 A	0.4 A	14 W		No	No			CJ1W-PA202
DC Power supply Units  	24 VDC	5 A	0.8 A	25 W		No	No	CJ1W-PD025	UC1, CE	
		2 A	0.4 A	19.6 W		No	No	CJ1W-PD022		

Programming Devices

Product name	Specifications			Model	Standards
		Number of licenses	Media		
FA Integrated Tool Package CX-One Ver. 4.□	The CX-One is a comprehensive software package that integrates Support Software for OMRON PLCs and components. CX-One runs on the following OS. Windows 7 (32-bit/64-bit version) / Windows 8 (32-bit/64-bit version) / Windows 8.1 (32-bit/64-bit version) / Windows 10 (32-bit/64-bit version) CX-One Ver.3.□ includes CX-Protocol Ver. 1.□, CX-Programmer Ver.8.□, CX-Designer Ver. 3.□, and CX-Process Tool Ver. 5.□, and NS Faceplate Auto-Builder version 3.□.	---	DVD	CXONE-AL00D-V4	---
		(Media only) *			
		1 license	DVD	CXONE-AL01D-V4	
		3 licenses	DVD	CXONE-AL03D-V4	
		10 licenses	DVD	CXONE-AL10D-V4	
		30 licenses	DVD	CXONE-AL30D-V4	
		50 licenses	DVD	CXONE-AL50D-V4	
CX-Designer	NS-series PT screen creation software for Windows 2000 (Service Pack 3a or higher), XP, or Vista CX-Designer version 3.□ or higher includes the Ladder Monitor Software. Note: The Ladder Monitor software allows ladder programming in a CS/CJ-series PLC to be monitored on an NS-series PT. To use System Program version 6.6 or earlier with the NS8/10/12-V1 or NS8/10/12-V2, a Memory Card and Memory Card Adapter must be ordered separately.	1 license	CD	NS-CXDC1-V4	---
Peripheral Device Connecting Cables (for peripheral port)	Connects IBM PC/AT or compatible computers, D-Sub 9-pin receptacle (Length: 0.1 m) (Conversion cable to connect RS-232C cable to peripheral port)			CS1W-CN118	CE
	Connects IBM PC/AT or compatible computers, D-Sub 9-pin (Length: 2.0 m)	Used for Peripheral Bus or Host Link.		CS1W-CN226	
	Connects IBM PC/AT or compatible computers, D-Sub 9-pin (Length: 6.0 m)			CS1W-CN626	
Peripheral Device Connecting Cables (for RS-232C port)	Connects IBM PC/AT or compatible computers, D-Sub 9-pin (Length: 2.0 m)	Used for Peripheral Bus or Host Link. Anti-static connector		XW2Z-200S-CV	---
	Connects IBM PC/AT or compatible computers, D-Sub 9-pin (Length: 5.0 m)			XW2Z-500S-CV	
	Connects IBM PC/AT or compatible computers, D-Sub 9-pin (Length: 2.0 m)	Used for Host Link only. Peripheral Bus not supported.		XW2Z-200S-V	
	Connects IBM PC/AT or compatible computers, D-Sub 9-pin (Length: 5.0 m)			XW2Z-500S-V	
USB-Serial Conversion Cable	USB-RS-232C Conversion Cable (Length: 0.5 m) and PC driver (on a CD-ROM disc), Complies with USB Specification 2.0 On personal computer side: USB (A plug connector, male) On PLC side: RS-232C (D-Sub 9-pin, male) OS: Windows 98, Me, 2000, XP, Vista, 7, 8, 10, or 11			CS1W-CIF31	N







Note: Site licenses are also available for users that need to use the CX-One on many computers. Ask your OMRON representative for details. When purchasing the DVD format, verify the computer model and DVD drive specifications before purchasing.

* The CXONE-AL00D-V4 contains only the DVD installation media for users who have purchased the CX-One Version 4.□ and does not include the license number. Enter the license number of the CX-One Version 4.□ when installing. (The license number of the CX-One Version 3.□ or lower cannot be used for installation.)

Ordering Information

Basic I/O Units

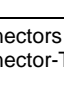



■ Input Units

Unit classification	Product name	Specifications						Current consumption (A)		Model	Standards
		I/O points	Input voltage current	Com-mons	Additional functions	External connection	No. of words allocated	5 V	24 V		
CJ1 Basic I/O Units	DC Input Units      	8 inputs	12 to 24 VDC, 10 mA	Independent contacts	None	Removable terminal block	1 word	0.09	---	CJ1W-ID201	UC1, N, L, CE
		16 inputs	24 VDC, 7 mA	16 points, 1 common		Removable terminal block	1 word	0.08	---	CJ1W-ID211	
		32 inputs	24 VDC, 4.1 mA	16 points, 1 common		Fujitsu / OTAX connector	2 words	0.09	---	CJ1W-ID231 (See note.)	
		32 inputs	24 VDC, 4.1 mA	16 points, 1 common		MIL connector	2 words	0.09	---	CJ1W-ID232 (See note.)	
		64 inputs	24 VDC, 4.1 mA	16 points, 1 common		Fujitsu / OTAX connector	4 words	0.09	---	CJ1W-ID261 (See note.)	
		64 inputs	24 VDC, 4.1 mA	16 points, 1 common		MIL connector	4 words	0.09	---	CJ1W-ID262 (See note.)	
	AC Input Units 	16 inputs	100 to 120 VAC, 7 mA (100 V, 50 Hz)	16 points, 1 common	Removable Terminal Block	1 word	0.09	---	CJ1W-IA111		
		8 inputs	200 to 240 VAC, 10 mA (200 V, 50 Hz)	8 points, 1 common	Removable Terminal Block	1 word	0.08	---	CJ1W-IA201		

Note: Connectors are not provided with these connector models. Either purchase one of the following 40-pin connectors, or use an OMRON XW2□ Connector-Terminal Block Conversion Unit or a G7□ I/O Relay Terminal.

Ordering Information



Output Units

Unit classification	Product name	Specifications					No. of words allocated	Current consumption (A)		Model	Standards
		I/O points	Maximum switching capacity	Commons	Additional functions	External connection		5 V	24 V		
CJ1 Basic I/O Units	Relay Contact Output Units 	8 outputs	250 VAC/24 VDC, 2 A	Independent contacts	None	Removable terminal block	1 word	0.09	0.048 max.	CJ1W-OC201	UC1, N, L, CE
		16 outputs	250 VAC/24 VDC, 2 A	16 points, 1 common			1 word	0.11	0.096 max.	CJ1W-OC211	
		8 outputs	12 to 24 VDC, 2 A, sinking	4 points, 1 common			1 word	0.09	---	CJ1W-OD201	
	Transistor Output Units   	8 outputs	24 VDC, 2 A, sourcing	4 points, 1 common	Short-circuit protection, disconnection detection	Removable terminal block	1 word	0.11	---	CJ1W-OD202	
		8 outputs	12 to 24 VDC, 0.5 A, sinking	8 points, 1 common	None	Removable terminal block	1 word	0.10	---	CJ1W-OD203	
		8 outputs	24 VDC, 0.5 A sourcing	8 points, 1 common	Short-circuit protection	Removable terminal block	1 word	0.10	---	CJ1W-OD204	
		16 outputs	12 to 24 VDC, 0.5 A, sinking	16 points, 1 common	None	Removable terminal block	1 word	0.10	---	CJ1W-OD211	
		16 outputs	24 VDC, 0.5 A, sourcing	16 points, 1 common	Short-circuit protection	Removable terminal block	1 word	0.10	---	CJ1W-OD212	
		32 outputs	12 to 24 VDC, 0.5 A, sinking	16 points, 1 common	None	Fujitsu / OTAX connector	2 words	0.14	---	CJ1W-OD231 (See note.)	
		32 outputs	24 VDC, 0.5 A, sourcing	16 points, 1 common	Short-circuit protection	MIL connector	2 words	0.15	---	CJ1W-OD232 (See note.)	
		32 outputs	12 to 24 VDC, 0.5 A, sinking	16 points, 1 common	None	MIL connector	2 words	0.14	---	CJ1W-OD233 (See note.)	
		64 outputs	12 to 24 VDC, 0.3 A, sinking	16 points, 1 common	None	Fujitsu / OTAX connector	4 words	0.17	---	CJ1W-OD261 (See note.)	
		64 outputs	24 VDC, 0.3 A, sourcing	16 points, 1 common	None	MIL connector	4 words	0.17	---	CJ1W-OD262 (See note.)	
		64 outputs	12 to 24 VDC, 0.3 A, sinking	16 points, 1 common	None	MIL connector	4 words	0.17	---	CJ1W-OD263 (See note.)	
Triac Output Units 	8 outputs	250 VAC, 0.6 A	8 points, 1 common	None	Removable terminal block	1 word	0.22	---	CJ1W-OA201		

Note: Connectors are not provided with these connector models. Either purchase one of the following 40-pin connectors, or use an OMRON XW2□ Connector-Terminal Block Conversion Unit or a G7□ I/O Relay Terminal.

Ordering Information

■ I/O Units

classification	Product name	Specifications							Current consumption (A)		Model	Standards
		I/O points	Input voltage, Input current	Com-mons	Additional functions	Exter-nal con-nection	No. of words allo-cated	5 V	24 V			
			Maximum switching capacity									
CJ1 Basic I/O Units	DC Input/ Transistor Output Units 	16 in-puts	24 VDC, 7 mA	16 points, 1 com-mon	None	Fujitsu / OTAX con-nect- tor	2 words	0.13	---	CJ1W-MD231 (See note 2.)	UC1, N, CE	
		16 out-puts	12 to 24 VDC, 0.5 A, sinking	16 points, 1 com-mon	None							
		16 in-puts	24 VDC, 7 mA	16 points, 1 com-mon	None	MIL con-nect- tor	2 words	0.13	---	CJ1W-MD232 (See note 2.)	UC1, N, L, CE	
		16 out-puts	24 VDC, 0.5 A, sourcing	16 points, 1 com-mon	Short-circuit protection							
		16 in-puts	24 VDC, 7 mA	16 points, 1 com-mon	None	MIL con-nect- tor	2 words	0.13	---	CJ1W-MD233 (See note 2.)	UC1, N, CE	
		16 out-puts	12 to 24 VDC, 0.5 A, sinking	16 points, 1 com-mon	None							
		32 in-puts	24 VDC, 4.1 mA	16 points, 1 com-mon	None	Fujitsu / OTAX con-nect- tor	4 words	0.14	---	CJ1W-MD261 (See note 1.)		
		32 out-puts	12 to 24 VDC, 0.3 A, sinking	16 points, 1 com-mon	None							
		32 in-puts	24 VDC, 4.1 mA	16 points, 1 com-mon	None	MIL con-nect- tor	4 words	0.14	---	CJ1W-MD263 (See note 1.)		
		32 out-puts	12 to 24 VDC, 0.3 A, sinking	16 points, 1 com-mon	None							
TTL I/O Units		32 in-puts	5 VDC, 3.5 mA	16 points, 1 com-mon	None	MIL con-nect- tor	4 words	0.19	---	CJ1W-MD563 (See note 1.)		
		32 out-puts	5 VDC, 35 mA	16 points, 1 com-mon	None							

- Note:** 1. Connectors are not provided with these connector models. Either purchase one of the following 40-pin Connectors, or use an OMRON XW2□ Connector-Terminal Block Conversion Unit or a G7□ I/O Relay Terminal.
 2. Connectors are not provided with these connector models. Either purchase one of the following 20-pin or 24-pin Connectors, or use an OMRON XW2□ Connector-Terminal Block Conversion Unit or a G7□ I/O Relay Terminal.

Applicable Connectors

Fujitsu / OTAX Connectors for 32-input, 32-output, 64-input, 64-output, 32-input/32-output

Name	Connection	Remarks	Applicable Units	Model	Standards
40-pin Connectors	Soldered	Connector Fujitsu FCN-361J040-AU Connector Cover Fujitsu FCN-360C040-J2 OTAX N360C040J2	Fujitsu / OTAX Connectors: CJ1W-ID231(32 inputs): 1 per Unit CJ1W-ID261 (64 inputs) 2 per Unit CJ1W-OD231 (32 outputs):1 per Unit CJ1W-OD261 (64 outputs): 2 per Unit CJ1W-MD261 (32 inputs, 32 outputs): 2 per Unit	C500-CE404	---
	Crimped	Housing Fujitsu FCN-363J040 OTAX N363J040		C500-CE405	
		Contacto Fujitsu FCN-363J-AU OTAX N363JAU			
		Connector Cover Fujitsu FCN-360C040-J2 OTAX N360C040J2			
Pressure welded	Fujitsu FCN-367J040-AU/F		C500-CE403		

Ordering Information

Special I/O Units

■ Process Input Units

Isolated-type Units with Fully Universal Inputs

Unit classification	Product name	I/O points	Signal range selection	Signal range	Conversion speed (resolution)	Accuracy at ambient temperature of 25°C	External connection	No. of unit numbers allocated	Current consumption (A)		Model	Standards
									5 V	24 V		
CJ1 Special I/O Units	Process Input Units (Isolated-type Units with Fully Universal Inputs) 	4 inputs	Set separately for each input	Fully universal inputs: Pt100 (3-wire), JPt100 (3-wire), Pt1000 (3-wire), Pt100 (4-wire), K, J, T, E, L, U, N, R, S, B, WRe5-26, PL II, 4 to 20 mA, 0 to 20 mA, 1 to 5 V, 0 to 1.25 V, 0 to 5 V, 0 to 10 V, ±100 mV selectable range -1.25 to 1.25 V, -5 to 5 V, -10 to 10 V, ±10 V selectable range, potentiometer	Resolution (conversion speed): 1/256,000 (conversion cycle: 60 ms/4 inputs) 1/64,000 (conversion cycle: 10 ms/4 inputs) 1/16,000 (conversion cycle: 5 ms/4 inputs)	Standard accuracy: ±0.05% of F.S.	Removable terminal block	1	0.30	---	CJ1W-PH41U (See note 1.)	UC1, CE
		4 inputs	Set separately for each input	Fully universal inputs: Pt100, JPt100, Pt1000, K, J, T, L, R, S, B, 4 to 20 mA, 0 to 20 mA, 1 to 5 V, 0 to 5 V, 0 to 10 V	Conversion speed: 250 ms/4 inputs	Accuracy: Platinum resistance thermometer input: ±0.3% of PV or ±0.8°C, whichever is larger) ±1 digit max. Thermocouple input: (±0.3% of PV or ±1.5°C, whichever is larger) ±1 digit max. (See note 2.) Voltage or current input: ±0.3% of F.S. ±1 digit max.				0.32	---	CJ1W-AD04U

Note: 1. Do not connect a Relay Contact Output Unit in the same CPU Rack or Expansion Rack as the CJ1W-PH41U Isolated-type Universal Input Unit.

2. L and -100°C or less for K and T are ±2°C ±1 digit max., and 200°C or less for R and S is ±3°C ±1 digit max. No accuracy is specified for 400°C or less for B.

Isolated-type Thermocouple Input Units

Unit classification	Product name	I/O points	Signal range selection	Signal range	Conversion speed (resolution)	Accuracy at ambient temperature of 25°C	External connection	No. of unit numbers allocated	Current consumption (A)		Model	Standards
									5 V	24 V		
CJ1 Special I/O Units	Process Input Units (Isolated-type Thermocouple Input Units) 	2 inputs	Set separately for each input	Thermocouple: B, E, J, K, L, N, R, S, T, U, WRe5-26, PLII DC voltage: ±100 mV	Conversion speed: 10 ms/ 2 inputs, Resolution: 1/64,000	Standard accuracy: ±0.05% of F.S. *1	Removable terminal block	1	0.18	0.06 *2	CJ1W-PTS15	UC1
		4 inputs	Common inputs	Thermocouple: R, S, K, J, T, L, B	Conversion speed: 250 ms/ 4 inputs	Accuracy: ±0.3% of PV or ±1°C, whichever is larger, ±1 digit max. *3			0.25	---	CJ1W-PTS51	UC1, CE

Note: This unit cannot be used, with the Machine Automation Controller NJ-series.

- *1. The accuracy depends on the sensors used and the measurement temperatures. For details, refer to the user's manual.
- *2. This is for an external power supply, and not for internal current consumption.
- *3. L and -100°C or less for K and T are ±2°C±1 digit max., and 200°C or less for R and S is ±3°C±1 digit max. No accuracy is specified for 400°C or less for B.

Isolated-type Resistance Thermometer Input Units

Unit classification	Product name	I/O points	Signal range selection	Signal range	Conversion speed (resolution)	Accuracy at ambient temperature of 25°C	External connection	No. of unit numbers allocated	Current consumption (A)		Model	Standards
									5 V	24 V		
CJ1 Special I/O Units	Process Input Units (Isolated-type Resistance Thermometer Input Units) 	4 inputs	Common inputs	Platinum resistance thermometer: Pt100, JPt100	Conversion speed: 250 ms/ 4 inputs	Accuracy: ±0.3% of PV or ±0.8°C, whichever is larger, ±1 digit max.	Removable terminal block	1	0.25	---	CJ1W-PTS52	UC1, CE

Note: This unit cannot be used, with the Machine Automation Controller NJ-series.

- * This is for an external power supply, and not for internal current consumption.

Ordering Information

Isolated-type DC Input Unit

Unit classification	Product name	I/O points	Signal range	Conversion speed (resolution)	Accuracy at ambient temperature of 25°C	External connection	No. of unit numbers allocated	Current consumption (A)		Model	Standards
								5 V	24 V		
CJ1 Special I/O Unit	Isolated-type DC Input Unit 	2 inputs	DC voltage: 0 to 1.25 V, -1.25 to 1.25 V, 0 to 5 V, 1 to 5 V, -5 to 5 V, 0 to 10 V, -10 to 10V, ±10-V selectable DC current: 0 to 20 mA, 4 to 20 mA	Conversion speed: 10 ms/ 2 inputs, Resolution: 1/64,000	Accuracy: ±0.05% of F.S.	Removable terminal block	1	0.18	0.09 (See note.)	CJ1W-PDC15	UC1, CE

Note: This is for an external power supply, and not for internal current consumption.

Ordering Information

■ Analog I/O Units

Analog Input Units

Unit classification	Product name	I/O points	Signal range selection	Signal range	Resolution	Conversion Speed	Accuracy at ambient temperature of 25°C)	External connection	No. of unit numbers allocated	Current consumption (A)		Model	Standards
										5 V	24 V		
CJ1 Special I/O Units 	Analog Input Units	8 in-puts	Set separately for each input	1 to 5 V, 0 to 5 V, 0 to 10 V, ±10 V, 4 to 20 mA	1/8,000 (Settable to 1/4,000) (See note 1.)	250 μs/point max. (Settable to 1 ms/point) (See note 1.)	Voltage: ±0.2% of F.S. Current: ±0.4% of F.S. (See note 2.)	Removable terminal block	1	0.42	---	CJ1W-AD081-V1	UC1, N, L, CE
		4 in-puts										Set separately for each input	

- Note:**
1. The resolution and conversion speed cannot be set independently. If the resolution is set to 1/4,000, then the conversion speed will be 1 ms/point.
 2. At 23 ±2°C
 3. For products manufactured from August 2007 onwards.

Analog Output Units

Unit classification	Product name	I/O points	Signal range selection	Signal range	Resolution	Conversion Speed	Accuracy at ambient temperature of 25°C)	External connection	External power supply	No. of unit numbers allocated	Current consumption (A)		Model	Standards
											5 V	24 V		
CJ1 Special I/O Units 	Analog Output Units	8 out-puts	Set separately for each input	1 to 5 V, 0 to 5 V, 0 to 10 V, -10 to 10 V	1/4,000 (Settable to 1/8,000) (See note 1.)	1 ms/point (Settable to 250 μs/point max.)	±0.3% of F.S.	Removable terminal block	24 VDC +10% -15%, 140 mA max.	1	0.14	0.14 (See note.)	CJ1W-DA08V	UC1, N, L, CE
		8 out-puts										4 to 20 mA	0.17 (See note.)	
		4 out-puts		1 to 5 V, 0 to 5 V, 0 to 10 V, -10 to 10 V, 4 to 20 mA	1/4,000	1 ms/point max.	Voltage: ±0.3% of F.S. Current: ±0.5% of F.S.	24 VDC +10% -15%, 200 mA max.	0.12	0.2 (See note.)	CJ1W-DA041	UC1, N, L, CE		
		2 out-puts									24 VDC +10% -15%, 140 mA max.		0.14 (See note.)	CS1W-DA021

Note: This is for an external power supply, and not for internal current consumption.

Ordering Information

Analog I/O Units

Unit classification	Product name	I/O points	Signal range selection	Signal range	Resolution	Conversion Speed	Accuracy at ambient temperature of 25°C)	External connection	No. of unit numbers allocated	Current consumption (A)		Model	Standards
										5 V	24 V		
CJ1 Special I/O Units	Analog I/O Units 	4 in-puts	Set separately for each input	1 to 5 V, 0 to 5 V, 0 to 10 V, -10 to 10 V, 4 to 20 mA	1/4,000 (Settable to 1/8,000)	1 ms/point (Settable to 500 μs/point max.)	Voltage: ±0.2% of F.S. Current: ±0.2% of F.S.	Removable terminal block	1	0.58	---	CJ1W-MAD42	UC1, N, L, CE
		2 out-puts											

Note: The resolution and conversion speed cannot be set independently. If the resolution is set to 1/4,000, then the conversion speed will be 1 ms/point.

Temperature Control Unit

Unit classification	Product name	Specifications			No. of unit numbers allocated	Current consumption (A)		Model	Standards
		No. of loops	Temperature sensor inputs	Control outputs		5 V	24 V		
CJ1 Special I/O Units	Temperature Control Units 	4 loops	Thermocouple input (R, S, K, J, T, B, L)	Open collector NPN outputs (pulses)	2	0.25	---	CJ1W-TC001	UC1, N, L, CE
		4 loops		Open collector PNP outputs (pulses)				CJ1W-TC002	
		2 loops, heater burnout detection function		Open collector NPN outputs (pulses)		CJ1W-TC003			
		2 loops, heater burnout detection function		Open collector PNP outputs (pulses)		CJ1W-TC004			
		4 loops	Platinum resistance thermometer input (JPt100, Pt100)	Open collector NPN outputs (pulses)		0.25	---	CJ1W-TC101	
		4 loops		Open collector PNP outputs (pulses)				CJ1W-TC102	
		2 loops, heater burnout detection function		Open collector NPN outputs (pulses)		0.25	---	CJ1W-TC103	
		2 loops, heater burnout detection function		Open collector PNP outputs (pulses)				CJ1W-TC104	

Ordering Information

CPU Bus Units

■ Controller Link Units

Controller Link Units, New Models

Unit classification	Product name	Specifications				No. of unit numbers allocated	Current consumption (A)		Model	Standards
		Communications cable	Communications type	Duplex support	Max. Units mountable per CPU Unit		5 V	24 V		
CJ1 CPU Bus Unit	Controller Link Unit 	Wired shielded twisted-pair cable (See note 2.)	Data links and message service	No	8	1	0.35	---	CJ1W-CLK23	UC1, N, L, CE

Repeater Units

Unit classification	Specifications	Model	Standards
Controller Link Repeater Unit 	Wire-to-wire Model	CS1W-RPT01	UC1, CE
	Wire-to-Optical (H-PCF) Model (See note 2.)	CS1W-RPT02	
	Wire-to-Optical (GI) Model (See note 3.)	CS1W-RPT03	

Note: 1. Using Repeater Units enables T-branches and long-distance wiring for Wired Controller Link networks. 62-node configurations, and converting part of the network to optical cable.

2. When using wire-to-optical (H-PCF) cable, use a H-PCF cable (for both Controller Link and SYSMAC LINK) or a H-PCF optical fiber cable with connector.
3. When using wire-to-optical (GI) cable, use a GI optical cable (for Controller Link).

Relay Terminal Block

Unit classification	Specifications	Model	Standards
Relay Terminal Block for Wired Controller Link Unit 	Use for Wired Controller Link Units (set of 5).	CS1W-TB101	---

Note: Controller Link Units can be replaced without stopping the communications of the entire network if a Relay Terminal Block is installed in advance on the Unit in a Wired Controller Link network. Relay Blocks cannot be used on Controller Link Support Boards.

Ordering Information

Serial Communications Units

Unit classification	Product name	Specifications		No. of unit numbers allocated	Current consumption (A)		Model	Standards
		Communications interface	Communications functions		5 V	24 V		
CJ1 CPU Bus Units	Serial Communications Units 	1 RS-232C port and 1 RS-422A/485 port	The following functions can be selected for each port: <ul style="list-style-type: none"> • Protocol macro • Host Link • NT Links (1:N mode) • Serial Gateway (See note 1.) • No-protocol (See note 2.) • Modbus-RTU Slave (See note 3.) 	1	0.38 (See note 4.)	---	CJ1W-SCU41-V1	UC1, N, L, CE
		2 RS-232C ports			CJ1W-SCU21-V1			
		2 RS-422A/485 ports			CJ1W-SCU31-V1			

- Note:**
1. The Serial Gateway function is enabled only for Serial Communications Units of unit version 1.2 and later.
 2. The no-protocol function is enabled only for Serial Communications Units of unit version 1.2 and later (and a CPU Unit of unit version 3.0 or later is also required).
 3. The Modbus-STU Slave function is enabled only for Serial Communications Units of unit version 1.3 and later.
 4. When an NT-AL001 RS-232C/RS-422A Conversion Unit is used, this value increases by 0.15 A/Unit. When a CJ1W-CIF11 RS-422A Conversion Unit is used, it increases by 0.04 A/Unit.

Ethernet Unit

Unit classification	Product name	Specifications			No. of unit numbers allocated	Current consumption (A)		Model	Standards
		Communications cable	Communications functions	Max. Units mountable per CPU Unit		5 V	24 V		
CJ1 CPU Bus Unit	Ethernet Unit 	100Base-TX	FINS communications service (TCP/IP, UDP/IP), FTP server functions, socket services, mail transmission service, mail reception (remote command receive), automatic adjustment of PLC built-in clock, server/host name specifications	4	1	0.37	---	CJ1W-ETN21	UC1, N, L, CE

FL-net Unit

Unit classification	Product name	Specifications			No. of unit numbers allocated	Current consumption (A)		Model	Standards
		Communications interface	Communications functions	Max. Units mountable per CPU Units		5 V	24 V		
CJ1 CPU Bus Units	FL-net Unit 	100Base-TX	With FL-net Ver. 2.0 specifications (OPCN-2), Data links and message service	4	1	0.37	---	CJ1W-FLN22	UC1, CE

DeviceNet Unit

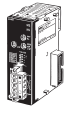
Unit classification	Product name	Specifications	Communications type	No. of unit numbers allocated	Current consumption (A)		Model	Standards
					5 V	24 V		
CJ1 CPU Bus Units	DeviceNet Unit 	Functions as master and/or slave; allows control of 32,000 points max. per master.	<ul style="list-style-type: none"> Remote I/O communications master (fixed or user-set allocations) Remote I/O communications slave (fixed or user-set allocations) Message communications 	1	0.29	---	CJ1W-DRM21	UC1, N, L, CE

CompoNet Master Unit

Unit classification	Product name	Specifications		No. of unit numbers allocated	Current consumption (A)		Model	Standards
		Communications functions	No. of I/O points per Master Unit		5 V	24 V		
CJ1 Special I/O Unit	CompoNet Master Unit 	<ul style="list-style-type: none"> Remote I/O communications Message communications 	Word Slaves: 2,048 max. (1,024 inputs and 1,024 outputs) Bit Slaves: 512 max. (256 inputs and 256 outputs)	1, 2, 4, or 8	0.4	---	CJ1W-CRM21	CE, U, U1, L, UC, UC1 (approval pending)

CompoBus/S Master Unit (No longer available to order)

Unit classification	Product name	Specifications			No. of unit numbers allocated	Current consumption (A)		Model	Standards
		Communications functions	No. of I/O points	Max. Units mountable per CPU Unit		5 V	24 V		
CJ1 Special I/O Unit	CompoBus/S Master Unit 	Remote I/O communications	256 max. (128 inputs and 128 outputs)	40	1 or 2 (variable)	0.15	---	CJ1W-SRM21	UC1, N, L, CE
	128 max. (64 inputs and 64 outputs)								



Ordering Information

ID Sensor Units

Unit classification	Product name	Specifications			No. of unit numbers allocated	Current consumption (A)		Model	Standards
		Connected ID System	No. of connected R/W heads	External power supply		5 V	24 V		
CJ1 Special I/O Units 	ID Sensor Units	V680 Series RFID System.	1	Not required.	1	0.26 (See notes 1 and 2.)	0.13 (See notes 1 and 2.)	CJ1W-V680C11	CE, UC (approval pending)
			2		2	0.32 (See note 2.)	0.26 (See note 2.)	CJ1W-V680C12	
		V600 Series RFID System	1	Not required.	1	0.26	0.12	CJ1W-V600C11	UC, CE
			2		2	0.32	0.24	CJ1W-V600C12	

Note: 1. To use a V680-H01 Antenna, refer to the *V680 Series RFID System Catalog* (Cat. No. Q151).
 2. Specifications subject to change without notice.

SYSMAC SPU (High-speed Data Storage Unit)

Unit classification	Product name	Specifications		No. of unit numbers allocated	Current consumption (A)		Model	Standards
		PC Card slot	Ethernet (LAN) port		5 V	24 V		
CJ1 CPU Bus Units 	SYSMAC SPU Ver. 2 (High-speed Data Storage Unit)	CF Card Type I/II × 1 slot Use an OMRON HMC-EF□□□ Memory Card.	1 port (10/100Base-TX)	1	0.56	---	CJ1W-SPU01-V2	UC1, CE
	SPU-Console Ver. 2.0	Functions: Unit settings, sampling settings, etc., for High-speed Data Collection Units (required for making settings for this Unit) OS : Microsoft Windows 10 (32 bit/64 bit) Microsoft Windows 8.1 (32 bit/64 bit) Microsoft Windows 8 (32 bit/64 bit) Microsoft Windows 7 (32 bit/64 bit)				WS02-SPTC1-V2		---
	SYSMAC SPU Data Management Middleware Ver. 2.0	Functions: Data files collected by SYSMAC SPU Data Management Middleware are automatically acquired at the personal computer, and can be registered in a database.			1 license	WS02-EDMC1-V2		---
		OS : Microsoft Windows 10 (32 bit/64 bit) Microsoft Windows 8.1 (32 bit/64 bit) Microsoft Windows 8 (32 bit/64 bit) Microsoft Windows 7 (32 bit/64 bit) Microsoft Windows Server 2012 Microsoft Windows Server 2008			5 licenses	WS02-EDMC1-V2L05		
	Memory Cards 	Flash memory, 128 MB			Note: A Memory Card is required for data collection.	HMC-EF183		N, L, CE
Flash memory, 256 MB (SYSMAC SPU only)			HMC-EF283					
Flash memory, 512 MB (SYSMAC SPU only)			HMC-EF583					
Flash memory 1 GB (SYSMAC SPU only)			HMC-EF194					

NS-series Programmable Terminals

Model name	Specifications		Model number		Standards
			Ethernet	Case color	
NS5-V2 *1	5.7-inch STN, 320 x 240 dots	No	Ivory	NS5-SQ10-V2 *2	UC1, CE, N, L, UL Type4
			Black	NS5-SQ10B-V2 *2	
		Yes	Ivory	NS5-SQ11-V2 *2	
			Black	NS5-SQ11B-V2 *2	
	5.7-inch TFT, 320 x 240 dots	No	Ivory	NS5-TQ10-V2 *2	
			Black	NS5-TQ10B-V2 *2	
		Yes	Ivory	NS5-TQ11-V2 *2	
			Black	NS5-TQ11B-V2 *2	
NS8-V2	8.4-inch TFT, 640 x 480 dots	No	Ivory	NS8-TV00-V2 *2	UC1, CE, N, L
			Black	NS8-TV00B-V2 *2	
		Yes	Ivory	NS8-TV01-V2 *2	
			Black	NS8-TV01B-V2 *2	
NS10-V2	10.4-inch TFT, 640 x 480 dots	No	Ivory	NS10-TV00-V2 *2	
			Black	NS10-TV00B-V2 *2	
		Yes	Ivory	NS10-TV01-V2 *2	
			Black	NS10-TV01B-V2 *2	
NS12-V2	12.1-inch TFT, 800 x 600 dots	No	Ivory	NS12-TS00-V2 *2	
			Black	NS12-TS00B-V2 *2	
		Yes	Ivory	NS12-TS01-V2 *2	
			Black	NS12-TS01B-V2 *2	
NSH5-V2 Hand-held	5.7-inch STN, 320 x 240 dots	No	Black (Emergency stop switch: red)	NSH5-SQR10B-V2 *2	UC, CE
			Black (Stop switch: gray)	NSH5-SQG10B-V2 *2	
Cable	Screen transfer cable for IBM PC/AT or compatible computers			XW2Z-S002	---
PT-to-PLC Connecting Cable	PT connection: 9 pins PLC connection: 9 pins	Length: 2 m		XW2Z-200T	---
		Length: 5 m		XW2Z-500T	
NSH5 Cables	RS-422A cable (loose wires)	Length: 10 m		NSH5-422CW-10M	
	RS-232C cable (loose wires)	Length: 3 m		NSH5-232CW-3M	
	RS-232C cable (loose wires)	Length: 10 m		NSH5-232CW-10M	

*1. As of July 2008, the image memory has been increased to 60 MB.

*2. Product no longer available to order.

■ NS-Runtime

Model name	Specifications		Media	Model number	Standards
NS-Runtime	NS-Runtime Installer, manual in PDF format, hardware key (See note.)	1 license	CD	NS-NSRCL1	---
		3 licenses		NS-NSRCL3	
		10 licenses		NS-NSRCL10	

Note: A hardware key (USB dongle) is required to run NS-Runtime.

Ordering Information

International Standards

- The standards are abbreviated as follows: U: UL, U1: UL (Class I Division 2 Products for Hazardous Locations), C: CSA, UC: cULus, UC1: cULus (Class I Division 2 Products for Hazardous Locations), CU: cUL, N: NK, L: Lloyd, and CE: EC Directives.
- Contact your OMRON representative for further details and applicable conditions for these standards.

EMC Directives

Applicable Standards

EMI: EN 61000-6-4

EMS: EN 61131-2 and EN 61000-6-2 (See note.)

PLCs are electrical devices that are incorporated in machines and manufacturing installations. OMRON PLCs conform to the related EMC standards so that the devices and machines into which they are built can more easily conform to EMC standards. The actual PLCs have been checked for conformity to EMC standards. Whether these standards are satisfied for the actual system, however, must be checked by the customer.

EMC-related performance will vary depending on the configuration, wiring, and other conditions of the equipment or control panel in which the PLC is installed. The customer must, therefore, perform final checks to confirm that the overall machine or device conforms to EMC standards.

Note: The applicable EMS standard depends on the product.

Low Voltage Directive

Applicable Standard: EN 61131-2

Devices that operate at voltages from 50 to 1,000 VAC or 75 to 150 VDC must satisfy the appropriate safety requirements. With PLCs, this applies to Power Supply Units and I/O Units that operate in these voltage ranges.

These Units have been designed to conform to EN 61131-2, which is the applicable standard for PLCs.

Read and Understand this Catalog

Please read and understand this catalog before purchasing the product. Please consult your OMRON representative if you have any questions or comments.

Warranty and Limitations of Liability

WARRANTY

OMRON's exclusive warranty is that the products are free from defects in materials and workmanship for a period of one year (or other period if specified) from date of sale by OMRON.

OMRON MAKES NO WARRANTY OR REPRESENTATION, EXPRESS OR IMPLIED, REGARDING NON-INFRINGEMENT, MERCHANTABILITY, OR FITNESS FOR PARTICULAR PURPOSE OF THE PRODUCTS. ANY BUYER OR USER ACKNOWLEDGES THAT THE BUYER OR USER ALONE HAS DETERMINED THAT THE PRODUCTS WILL SUITABLY MEET THE REQUIREMENTS OF THEIR INTENDED USE. OMRON DISCLAIMS ALL OTHER WARRANTIES, EXPRESS OR IMPLIED.

LIMITATIONS OF LIABILITY

OMRON SHALL NOT BE RESPONSIBLE FOR SPECIAL, INDIRECT, OR CONSEQUENTIAL DAMAGES, LOSS OF PROFITS OR COMMERCIAL LOSS IN ANY WAY CONNECTED WITH THE PRODUCTS, WHETHER SUCH CLAIM IS BASED ON CONTRACT, WARRANTY, NEGLIGENCE, OR STRICT LIABILITY.

In no event shall the responsibility of OMRON for any act exceed the individual price of the product on which liability is asserted.

IN NO EVENT SHALL OMRON BE RESPONSIBLE FOR WARRANTY, REPAIR, OR OTHER CLAIMS REGARDING THE PRODUCTS UNLESS OMRON'S ANALYSIS CONFIRMS THAT THE PRODUCTS WERE PROPERLY HANDLED, STORED, INSTALLED, AND MAINTAINED AND NOT SUBJECT TO CONTAMINATION, ABUSE, MISUSE, OR INAPPROPRIATE MODIFICATION OR REPAIR.

Application Considerations

SUITABILITY FOR USE

OMRON shall not be responsible for conformity with any standards, codes, or regulations that apply to the combination of the product in the customer's application or use of the product.

Take all necessary steps to determine the suitability of the product for the systems, machines, and equipment with which it will be used.

Know and observe all prohibitions of use applicable to this product.

NEVER USE THE PRODUCT FOR AN APPLICATION INVOLVING SERIOUS RISK TO LIFE OR PROPERTY WITHOUT ENSURING THAT THE SYSTEM AS A WHOLE HAS BEEN DESIGNED TO ADDRESS THE RISKS, AND THAT THE OMRON PRODUCT IS PROPERLY RATED AND INSTALLED FOR THE INTENDED USE WITHIN THE OVERALL EQUIPMENT OR SYSTEM.

PROGRAMMABLE PRODUCTS

OMRON shall not be responsible for the user's programming of a programmable product, or any consequence thereof.

Disclaimers

CHANGE IN SPECIFICATIONS

Product specifications and accessories may be changed at any time based on improvements and other reasons. Consult with your OMRON representative at any time to confirm actual specifications of purchased product.

DIMENSIONS AND WEIGHTS

Dimensions and weights are nominal and are not to be used for manufacturing purposes, even when tolerances are shown.

PERFORMANCE DATA

Performance data given in this catalog is provided as a guide for the user in determining suitability and does not constitute a warranty. It may represent the result of OMRON's test conditions, and the users must correlate it to actual application requirements. Actual performance is subject to the OMRON Warranty and Limitations of Liability.



Note: Do not use this document to operate the Unit.

OMRON Corporation Industrial Automation Company

Kyoto, JAPAN

Contact : www.ia.omron.com

Regional Headquarters

OMRON EUROPE B.V.

Wegalaan 67-69, 2132 JD Hoofddorp
The Netherlands
Tel: (31) 2356-81-300 Fax: (31) 2356-81-388

OMRON ASIA PACIFIC PTE. LTD.

438B Alexandra Road, #08-01/02 Alexandra
Technopark, Singapore 119968
Tel: (65) 6835-3011 Fax: (65) 6835-2711

OMRON ELECTRONICS LLC

2895 Greenspoint Parkway, Suite 200
Hoffman Estates, IL 60169 U.S.A.
Tel: (1) 847-843-7900 Fax: (1) 847-843-7787

OMRON (CHINA) CO., LTD.

Room 2211, Bank of China Tower,
200 Yin Cheng Zhong Road,
PuDong New Area, Shanghai, 200120, China
Tel: (86) 21-5037-2222 Fax: (86) 21-5037-2200

Authorized Distributor:

©OMRON Corporation 2004-2022 All Rights Reserved.
In the interest of product improvement,
specifications are subject to change without notice.

CSM_12_11 Printed in Japan
Cat. No. R128-E1-12 1222 (1104)