

Check Valves

CV, CH, CO, CA, COA, CL and CW Series



Check Valves
Relief Valves

Check Valves

CV, CH, CO, CA, COA, CL and CW Series



Features

CV Series

- ⦿ Resilient O-ring seat design for leak free sealing
- ⦿ Working pressure up to: 3000 psig (207 bar)
- ⦿ Working temperature: -10°F to 375°F (-23°C to 190°C)
- ⦿ Cracking pressure: 1/3 to 25 psig (0.02 to 1.7 bar)
- ⦿ Variety of end connections and materials available
- ⦿ Fixed cracking pressure, mountable in any directions

CH Series

- ⦿ Seat ring continuously cleaned by media, avoiding secondary pollution
- ⦿ Working pressure up to: 6000 psig (414 bar)
- ⦿ Working temperature: -10°F to 400°F (-23°C to 204°C)
- ⦿ Cracking pressure: 1/3 to 25 psig (0.02 to 1.7 bar)
- ⦿ Variety of end connections and materials available
- ⦿ Fixed cracking pressure, mountable in any directions

CO Series

- ⦿ Compact design, one piece body
- ⦿ Working pressure up to: 3000 psig (207 bar)
- ⦿ Working temperature: -10°F to 375°F (-23°C to 190°C)
- ⦿ Cracking pressure: 1/3 to 25 psig (0.02 to 1.7 bar)
- ⦿ Variety of end connections and materials available
- ⦿ Fixed cracking pressure, mountable in any directions

CA Series

- ⦿ Working pressure up to: 3000 psig (207 bar)
- ⦿ Working temperature: -10°F to 375°F (-23°C to 190°C)
- ⦿ Cracking pressure: 3 to 600 psig (0.2 to 41.4 bar)
- ⦿ Variety of end connections and materials available
- ⦿ Various springs available
- ⦿ Adjustable cracking pressure, mountable in any directions

COA Series

- ⦿ Compact design, one-piece body
- ⦿ Working pressure up to: 3000 psig (207 bar)
- ⦿ Working temperature: -10°F to 375°F (-23°C to 190°C)
- ⦿ Cracking pressure: 3 to 600 psig (0.2 to 41.4 bar)
- ⦿ Variety of end connections and materials available
- ⦿ Various springs available
- ⦿ Adjustable cracking pressure, mountable in any directions

CL Series

- ⦿ Working pressure up to: 6000 psig (414 bar)
- ⦿ Working temperature: -65°F to 900°F (-53°C to 482°C)
- ⦿ Rugged, all-stainless steel construction
- ⦿ Union bonnet design, all-stainless steel structure, horizontal installation with bonnet nut on top
- ⦿ Reverse flow coefficient less than 0.1% of forward flow coefficient

CW Series

- ⦿ Working pressure up to: 3000 psig (207 bar)
- ⦿ Working temperature: -10°F to 400°F (-23°C to 204°C)
- ⦿ Cracking pressure: less than 2 psig (0.14 bar)
- ⦿ Variety of end connections and materials available
- ⦿ All-welded design for safety
- ⦿ Standard or fine polished wetted surfaces optional

1. Besides CL series, other check valves are all coated with lubricants like silicone base and molybdenum disulfide base.
2. Please contact FITOK Group or our authorized distributors for other materials.
3. PTFE-coated spring is an option for CV, CO, CA, and COA series check valves. For more details, please contact FITOK Group or our authorized distributors.
4. Every valve is tested with nitrogen for leak-tight performance at its maximum working pressure.

Cracking Pressure and Reseal Pressure

Cracking pressure - the upstream pressure at which the first indication of flow occurs.

Reseal pressure - the pressure at which there is no indication of flow.

Series	Nominal Cracking Pressure psig (bar)	Cracking Pressure Range psig (bar)	Reseal Pressure Range psig (bar)
CV	1/3 (0.02) 1 (0.06) 3 (0.21) 10 (0.68) 25 (1.7)	0 to 3 (0 to 0.21) 0 to 4 (0 to 0.28) 1 to 5 (0.06 to 0.34) 7 to 15 (0.49 to 1.1) 20 to 30 (1.4 to 2.1)	Up to 6 (0.42) downstream pressure Up to 6 (0.42) downstream pressure Up to 6 (0.42) downstream pressure 3 (0.21) or higher upstream pressure 17 (1.2) or higher upstream pressure
CH	1/3 (0.02) 1 (0.06) 3 (0.21) 10 (0.68) 25 (1.7)	0 to 3 (0 to 0.21) 0 to 4 (0 to 0.28) 1 to 5 (0.06 to 0.34) 7 to 15 (0.49 to 1.1) 20 to 30 (1.4 to 2.1)	Up to 6 (0.42) downstream pressure Up to 5 (0.35) downstream pressure Up to 2 (0.14) downstream pressure 3 (0.21) or higher upstream pressure 17 (1.2) or higher upstream pressure
CO	1/3 (0.02) 1 (0.06) 3 (0.21) 10 (0.68) 25 (1.7)	0 to 3 (0 to 0.21) 0 to 4 (0 to 0.28) 1 to 5 (0.06 to 0.34) 7 to 15 (0.49 to 1.1) 20 to 30 (1.4 to 2.1)	6 to 20 (0.42 to 1.4) downstream pressure 5 to 20 (0.35 to 1.4) downstream pressure 3 to 20 (0.21 to 1.4) downstream pressure 3 to 10 (0.21 to 0.68) downstream pressure 5 (0.35) or higher upstream pressure
CA	3 to 50 (0.21 to 3.4) 50 to 150 (3.4 to 10.3)	—————	Refer to the chart below
COA	150 to 350 (10.3 to 24.1) 350 to 600 (24.1 to 41.3)		
CW	1/3 (0.02)	0 to 2 (0 to 0.14)	Up to 2 (0.14) downstream pressure

Check Valves
Relief Valves

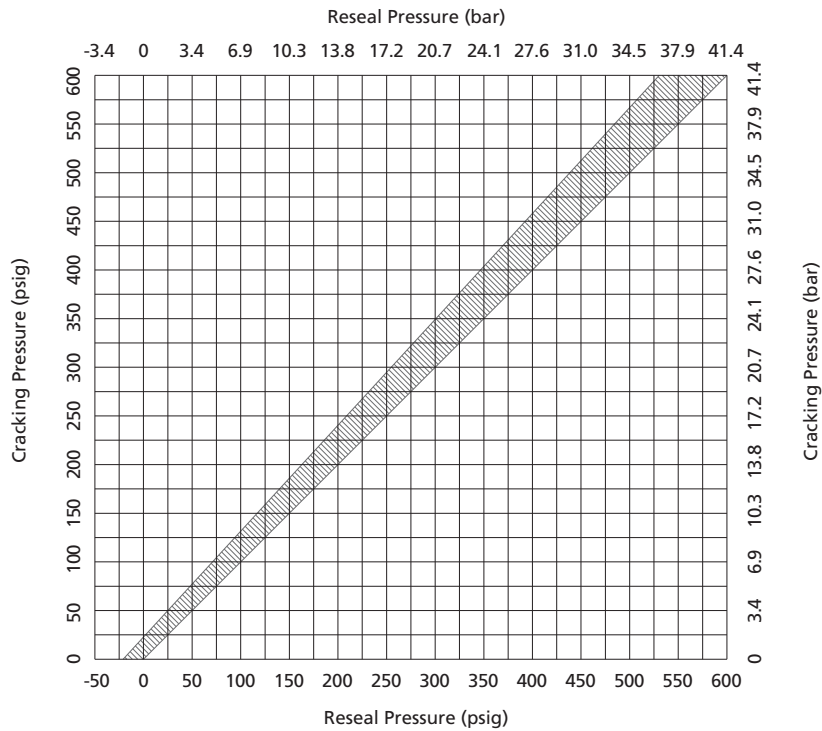

Pressure vs. Temperature

CV Series

FKM O-ring in 316 SS Body and Buna N in Brass Body

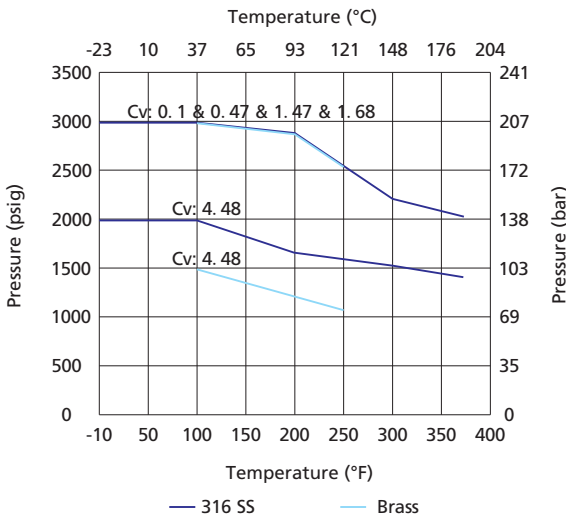

CO, CA and COA Series

FKM O-ring in 316 SS Body and Buna N in Brass Body

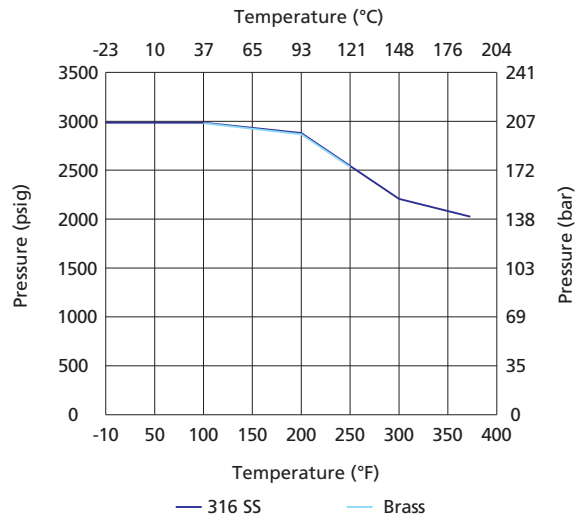

CL Series

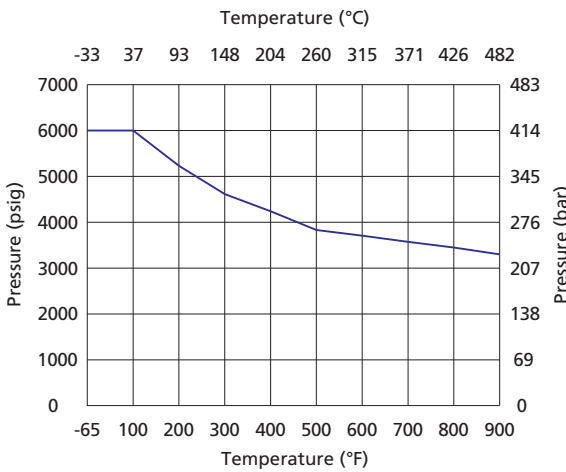

CH Series

FKM O-ring in 316 SS Body

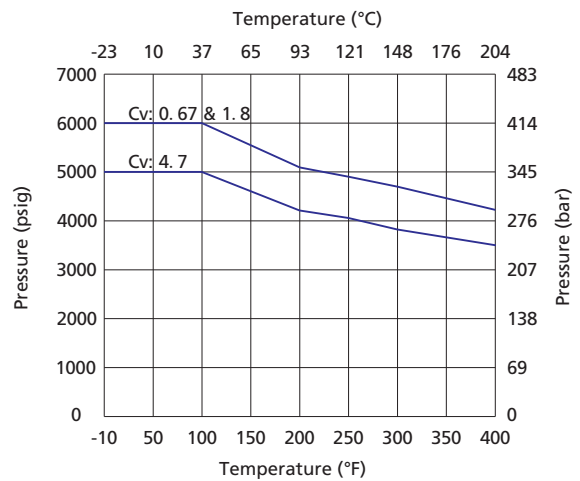

CW Series

FKM O-ring in 316 SS Body

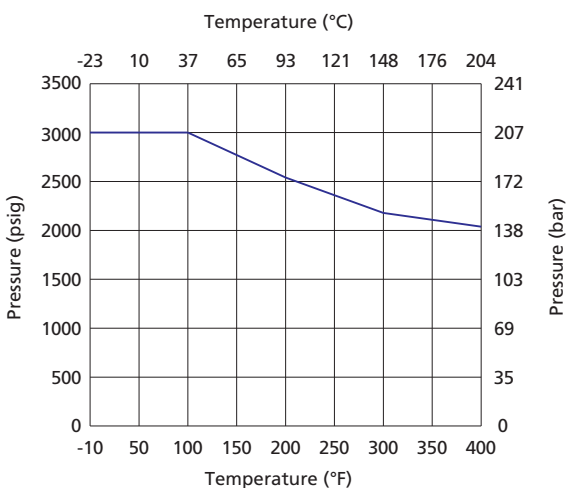

The temperature rating of CH Series check valve is restricted by the connection types. For details please refer to B-134.

Standard Materials of Construction

CV Series

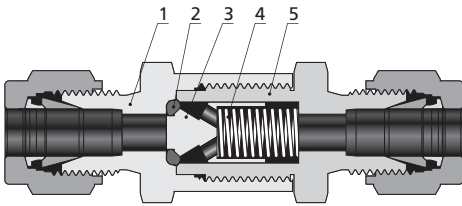

Component		Material Grade/ASTM Specification	
		316 SS	Brass
1	Inlet Body	316 SS/A479	Brass C36000/B16
2	O-ring	Fluorocarbon FKM	Buna N
3	Poppet	316 SS/A479	Brass C36000/B16
4	Spring	302 SS/A313	302 SS/A313
5	Outlet Body	316 SS/A479	Brass C36000/B16

CH Series

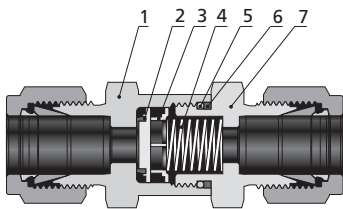

Component		Material Grade/ASTM Specification
1	Inlet Body	316 SS/A479
2	Poppet	Fluorocarbon-FKM-bonded 316 SS/A479
3	Poppet Stop	316 SS/A240
4	Spring	302 SS/A313
5	O-ring	Fluorocarbon FKM
6	Backup Ring	PTFE/D1710
7	Outlet Body	316 SS/A479

CO Series

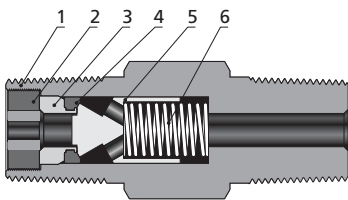

Component		Material Grade/ASTM Specification	
		316 SS	Brass
1	Body	316 SS/A479	Brass C36000/B16
2	Insert Locking Screw	316 SS/A276 or A479	Brass C36000/B16
3	Insert	316 SS/A479	Brass C36000/B16
4	O-ring	Fluorocarbon FKM	Buna N
5	Poppet	316 SS/A479	Brass C36000/B16
6	Spring	302 SS/A313	302 SS/A313

CA Series

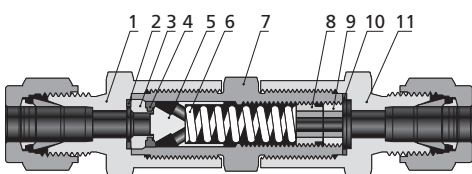

Component		Material Grade/ASTM Specification	
		316 SS	Brass
1	Inlet Body	316 SS/A479	Brass C36000/B16
2	Inlet Gasket	PTFE-coated 316 SS/A240	PTFE-coated 316 SS/A240
3	Insert	316 SS/A479	Brass C36000/B16
4	O-ring	Fluorocarbon FKM	Buna N
5	Poppet	316 SS/A479	Brass C36000/B16
6	Spring	302 SS/A313	302 SS/A313
7	Center Body	316 SS/A479	Brass C36000/B16
8	Adjusting Screw	316 SS/A276	316 SS/A276
9	Locking Screw	316 SS/A276	316 SS/A276
10	Outlet Gasket	PTFE-coated 316 SS/A276	PTFE-coated 316 SS/A276
11	Outlet Body	316 SS/A479	Brass C36000/B16

COA Series

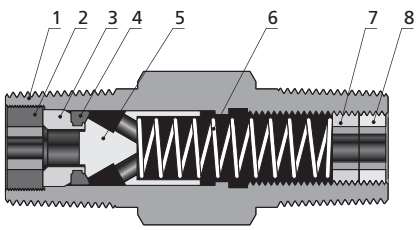

Component		Material Grade/ASTM Specification	
		316 SS	Brass
1	Body	316 SS/A479	Brass C36000/B16
2	Insert Locking Screw	316 SS/A479	Brass C36000/B16
3	Insert	316 SS/A479	Brass C36000/B16
4	O-ring	Fluorocarbon FKM	Buna N
5	Poppet	316 SS/A479	Brass C36000/B16
6	Spring	302 SS/A313	302 SS/A313
7	Adjusting Screw	316 SS/A276	316 SS/A276
8	Locking Screw	316 SS/A276	316 SS/A276

CL Series

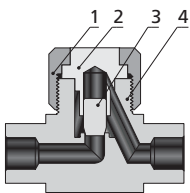

Component		Material Grade/ASTM Specification
1	Bonnet Nut	316 SS/A479
2	Bonnet	316 SS/A479
3	Poppet	S17400/A564
4	Body	316 SS/A479

CW Series

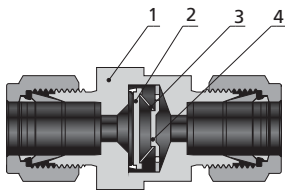

Component		Material Grade/ASTM Specification
1	Body	316L SS/A479
2	Poppet	Fluorocarbon FKM-bonded 316 SS/A479
3	Belleville Spring	Alloy X - 750/B637
4	Poppet Stop	316L SS/A240

Dimensions

CV Series

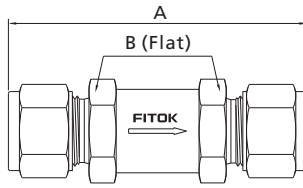

Basic Ordering Number	Connection Type and Size		Cv	Dimensions, in. (mm)	
	Inlet	Outlet		A	B
CV□□-FL2-	1/8" FITOK	1/8" FITOK	0.10	2.14 (54.3)	5/8 (15.9)
CV□□-FL4-	1/4" FITOK	1/4" FITOK	0.47	2.35 (59.7)	
CV□□-FL6-	3/8" FITOK	3/8" FITOK	1.47	3.17 (80.5)	7/8 (22.2)
CV□□-FL8-	1/2" FITOK	1/2" FITOK	1.68	3.42 (86.9)	
CV□□-FL12-	3/4" FITOK	3/4" FITOK	4.48	4.32 (110.0)	1 1/4 (31.8)
CV□□-FL16-	1" FITOK	1" FITOK		4.74 (120.0)	1 3/8 (34.9)
CV□□-ML6-	6 mm FITOK	6 mm FITOK	0.47	2.36 (59.9)	5/8 (15.9)
CV□□-ML10-	10 mm FITOK	10 mm FITOK	1.68	3.32 (84.3)	7/8 (22.2)
CV□□-ML12-	12 mm FITOK	12 mm FITOK		3.42 (86.9)	
CV□□-FNS2-	1/8 Female NPT	1/8 Female NPT	0.10	1.89 (48.0)	5/8 (15.9)
CV□□-FNS4-	1/4 Female NPT	1/4 Female NPT	0.47	2.15 (54.6)	3/4 (19.1)
CV□□-FNS6-	3/8 Female NPT	3/8 Female NPT	1.47	2.98 (75.7)	7/8 (22.2)
CV□□-FNS8-	1/2 Female NPT	1/2 Female NPT	1.68	3.58 (90.9)	1 1/16 (27.0)
CV□□-FNS12-	3/4 Female NPT	3/4 Female NPT	4.48	4.08 (104.0)	1 1/4 (31.8)
CV□□-FNS16-	1 Female NPT	1 Female NPT		4.84 (123.0)	1 5/8 (41.3)
CV□□-NS2-	1/8 Male NPT	1/8 Male NPT	0.10	1.71 (43.4)	5/8 (15.9)
CV□□-NS4-	1/4 Male NPT	1/4 Male NPT	0.47	2.09 (53.1)	
CV□□-NS6-	3/8 Male NPT	3/8 Male NPT	1.47	2.78 (70.6)	7/8 (22.2)
CV□□-NS8-	1/2 Male NPT	1/2 Male NPT	1.68	3.16 (80.3)	
CV□□-NS12-	3/4 Male NPT	3/4 Male NPT	4.48	4.08 (104.0)	1 1/4 (31.8)
CV□□-NS16-	1 Male NPT	1 Male NPT		4.52 (115.0)	1 5/8 (41.3)
CV□□-FR4-	1/4" Male FR	1/4" Male FR	0.47	2.21 (56.1)	5/8 (15.9)
CV□□-FR8-	1/2" Male FR	1/2" Male FR	1.68	3.56 (90.4)	15/16 (23.8)
CV□□-FR12-	3/4" Male FR	3/4" Male FR	4.48	4.64 (118.0)	1 5/8 (41.3)
CV□□-FR16-	1" Male FR	1" Male FR		4.76 (121.0)	

Ordering Number Description

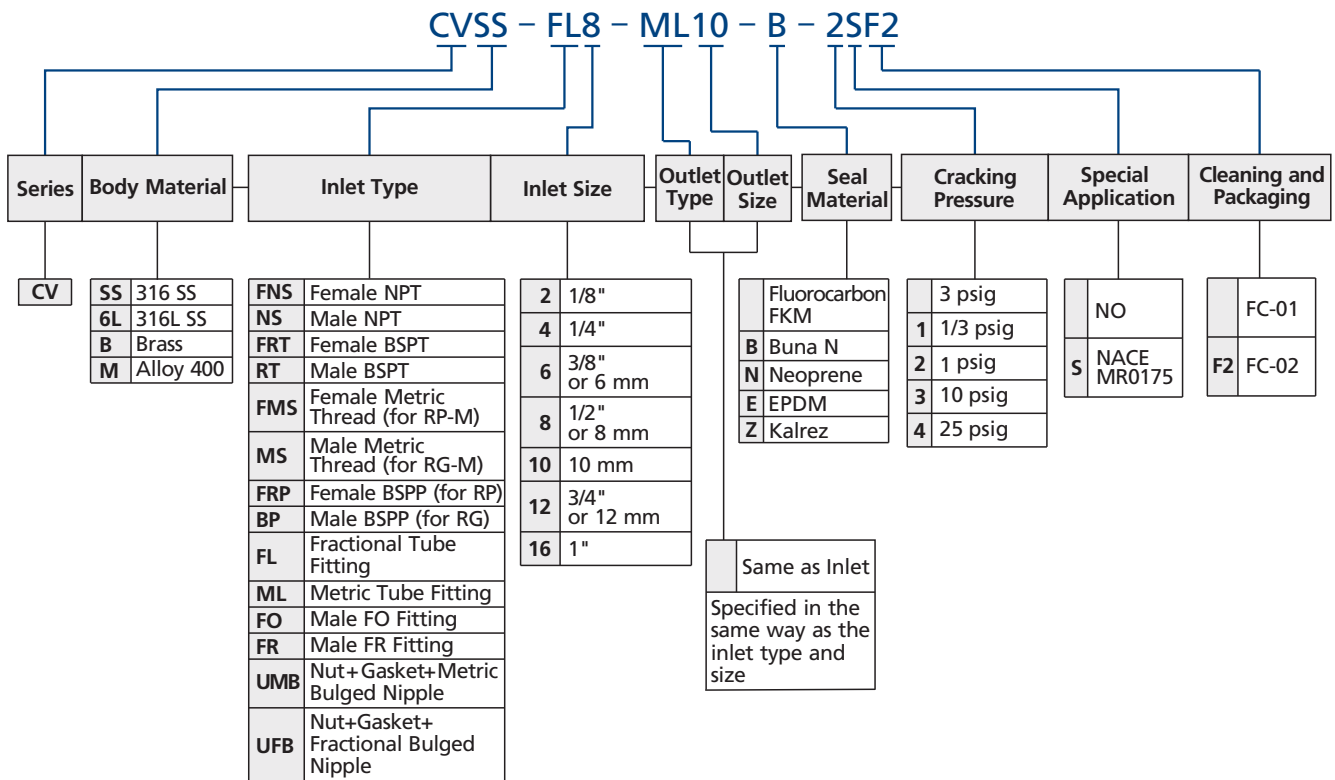

- Standard thread pitch for metric threads are as follows:
 M10 and below: 1 mm
 M12 to M24: 1.5 mm
 M27 and above: 2 mm
 Standard thread pitch should be omitted in the ordering number, others should be specified.
- For oxygen-enriched environment or hazardous media service, please contact FITOK Group or our authorized distributors.
- Cleaning and Packaging:
 FC-01: Standard cleaning and packaging for general industrial procedures.
 FC-02: Special cleaning and packaging for wetted system components to ensure compliance with product cleanliness requirement of ASTM G93 Level C.
- The materials, connection types and sizes listed in the "Ordering Number Description" are standard. For other materials and end connections, please contact FITOK Group or our authorized distributors.
- PTFE-coated gasket can be chosen to reduce the possibility of O-ring's moving in system caused by the pressure fluctuations, vibration or pulsating. For more details, please contact FITOK Group or our authorized distributors.
- Check valve is designed with unidirectional flow path, it can't be used as safety relief valve.
- If the check valve is not opened for a period of time, its initial cracking pressure may be higher than set cracking pressure.

Check Valves
Relief Valves

B-134 Check Valves

CH Series

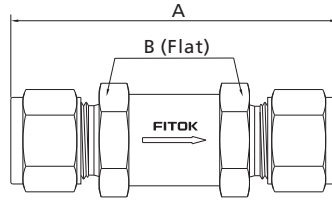

Basic Ordering Number	Connection Type and Size		Pressure Rating at 100° F (37° C) bar (psig)	Cv	Dimensions, in. (mm)	
	Inlet	Outlet			A	B
CH□□-FL2-	1/8" FITOK	1/8" FITOK	414 (6000)	0.67	2.27 (57.7)	11/16 (17.5)
CH□□-FL4-	1/4" FITOK	1/4" FITOK			2.43 (61.7)	
CH□□-FL6-	3/8" FITOK	3/8" FITOK		1.8	2.75 (69.9)	1 (25.4)
CH□□-FL8-	1/2" FITOK	1/2" FITOK			2.96 (75.2)	
CH□□-FL12-	3/4" FITOK	3/4" FITOK	344 (5000)	4.7	3.52 (89.4)	1 5/8 (41.3)
CH□□-FL16-	1" FITOK	1" FITOK	323 (4700)		3.88 (98.6)	
CH□□-ML6-	6 mm FITOK	6 mm FITOK	414 (6000)	0.67	2.43 (61.7)	11/16 (17.5)
CH□□-ML8-	8 mm FITOK	8 mm FITOK			2.70 (68.6)	
CH□□-ML10-	10 mm FITOK	10 mm FITOK		1.8	2.80 (71.1)	1 (25.4)
CH□□-ML12-	12 mm FITOK	12 mm FITOK			2.96 (75.2)	
CH□□-ML22-	22 mm FITOK	22 mm FITOK	337 (4900)	4.7	3.48 (88.4)	1 5/8 (41.3)
CH□□-ML25-	25 mm FITOK	25 mm FITOK	316 (4600)		3.88 (98.6)	
CH□□-FNS4-	1/4 Female NPT	1/4 Female NPT	414 (6000)	0.67	2.13 (54.1)	11/16 (17.5)
CH□□-FNS6-	3/8 Female NPT	3/8 Female NPT	365 (5300)	1.8	2.55 (64.8)	1 (25.4)
CH□□-FNS8-	1/2 Female NPT	1/2 Female NPT	337 (4900)		3.03 (77.0)	1 1/16 (27.0)
CH□□-FNS12-	3/4 Female NPT	3/4 Female NPT	316 (4600)	4.7	3.23 (82.0)	1 5/8 (41.3)
CH□□-FNS16-	1 Female NPT	1 Female NPT	303 (4400)		3.83 (97.3)	
CH□□-NS2-	1/8 Male NPT	1/8 Male NPT	414 (6000)	0.67	1.79 (45.4)	11/16 (17.5)
CH□□-NS4-	1/4 Male NPT	1/4 Male NPT			2.17 (55.1)	
CH□□-NS6-	3/8 Male NPT	3/8 Male NPT		1.8	2.36 (59.9)	1 (25.4)
CH□□-NS8-	1/2 Male NPT	1/2 Male NPT			2.73 (69.3)	
CH□□-NS12-	3/4 Male NPT	3/4 Male NPT	344 (5000)	4.7	3.29 (83.6)	1 5/8 (41.3)
CH□□-NS16-	1 Male NPT	1 Male NPT	367 (93.2)			
CH□□-FRT4-	1/4 Female BSPT	1/4 Female BSPT	414 (6000)	0.67	2.28 (57.9)	11/16 (17.5)
CH□□-FRT8-	1/2 Female BSPT	1/2 Female BSPT	351 (5100)	1.8	3.29 (83.6)	1 1/16 (27.0)
CH□□-FRT12-	3/4 Female BSPT	3/4 Female BSPT	330 (4800)	4.7	3.55 (90.2)	1 5/8 (41.3)
CH□□-FRT16-	1 Female BSPT	1 Female BSPT	303 (4400)		3.83 (97.3)	
CH□□-RT4-	1/4 Male BSPT	1/4 Male BSPT	414 (6000)	0.67	2.17 (55.1)	11/16 (17.5)
CH□□-RT8-	1/2 Male BSPT	1/2 Male BSPT		1.8	2.73 (69.3)	1 (25.4)
CH□□-RT12-	3/4 Male BSPT	3/4 Male BSPT	344 (5000)	4.7	3.35 (85.1)	1 5/8 (41.3)
CH□□-RT16-	1 Male BSPT	1 Male BSPT	3.67 (93.2)			
CH□□-FR4-	1/4" Male FR	1/4" Male FR	414 (6000)	0.67	2.28 (57.9)	11/16 (17.5)
CH□□-FR8-	1/2" Male FR	1/2" Male FR	296 (4300)	1.8	2.73 (69.3)	1 (25.4)
CH□□-FR12-	3/4" Male FR	3/4" Male FR	254 (3700)	4.7	3.78 (96.0)	1 5/8 (41.3)
CH□□-FO4-	1/4" Male FO	1/4" Male FO	414 (6000)	0.67	1.98 (50.3)	11/16 (17.5)
CH□□-FO8-	1/2" Male FO	1/2" Male FO		1.8	2.35 (59.7)	1 (25.4)
CH□□-FO12-	3/4" Male FO	3/4" Male FO	344 (5000)	4.7	2.90 (73.7)	1 5/8 (41.3)
CH□□-FO16-	1" Male FO	1" Male FO				

Ordering Number Description

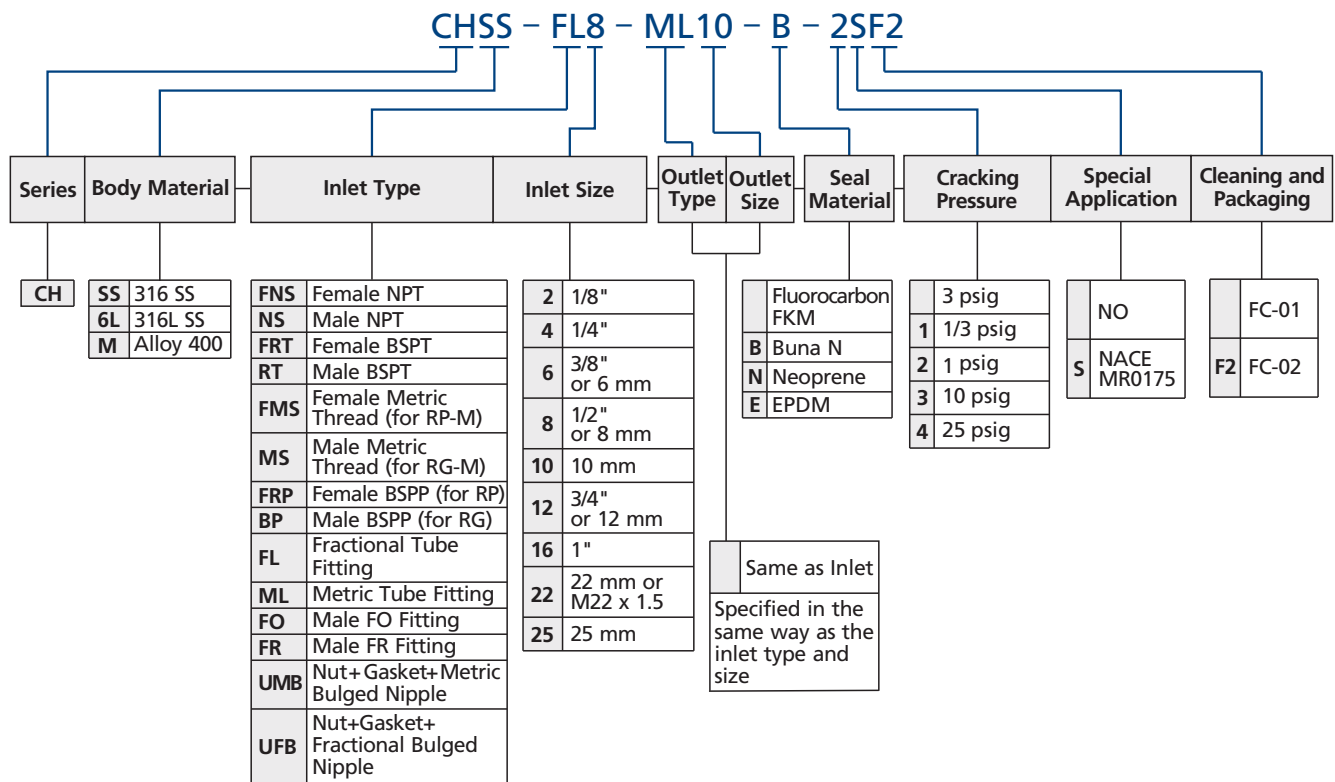

- Standard thread pitch for metric threads are as follows:
M10 and below: 1 mm
M12 to M24: 1.5 mm
M27 and above: 2 mm
Standard thread pitch should be omitted in the ordering number, others should be specified.
- For oxygen-enriched environment or hazardous media service, please contact FITOK Group or our authorized distributors.
- Cleaning and Packaging:
FC-01: Standard cleaning and packaging for general industrial procedures.
FC-02: Special cleaning and packaging for wetted system components to ensure compliance with product cleanliness requirement of ASTM G93 Level C.
- The materials, connection types and sizes listed in the "Ordering Number Description" are standard. For other materials and end connections, please contact FITOK Group or our authorized distributors.
- Check valve is designed with unidirectional flow path, it can't be used as safety relief valve.
- If the check valve is not opened for a period of time, its initial cracking pressure may be higher than set cracking pressure.

CO Series

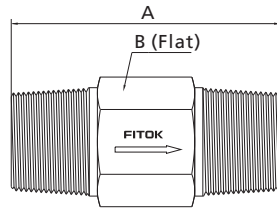

Basic Ordering Number	Connection Type and Size		CV	Dimensions, in. (mm)	
	Inlet	Outlet		A	B
CO□□-FNS4-	1/4 Female NPT	1/4 Female NPT	0.35	2.41 (61.2)	3/4 (19.1)
CO□□-FNS8-	1/2 Female NPT	1/2 Female NPT	1.20	3.71 (94.2)	1 1/16 (27.0)
CO□□-NS4-	1/4 Male NPT	1/4 Male NPT	0.35	1.62 (41.1)	9/16 (14.3)
CO□□-NS8-	1/2 Male NPT	1/2 Male NPT	1.20	2.28 (57.9)	7/8 (22.2)
CO□□-FRT4-	1/4 Female BSPT	1/4 Female BSPT	0.35	2.54 (64.5)	3/4 (19.1)
CO□□-RT4-	1/4 Male BSPT	1/4 Male BSPT		1.62 (41.1)	9/16 (14.3)

Ordering Number Description

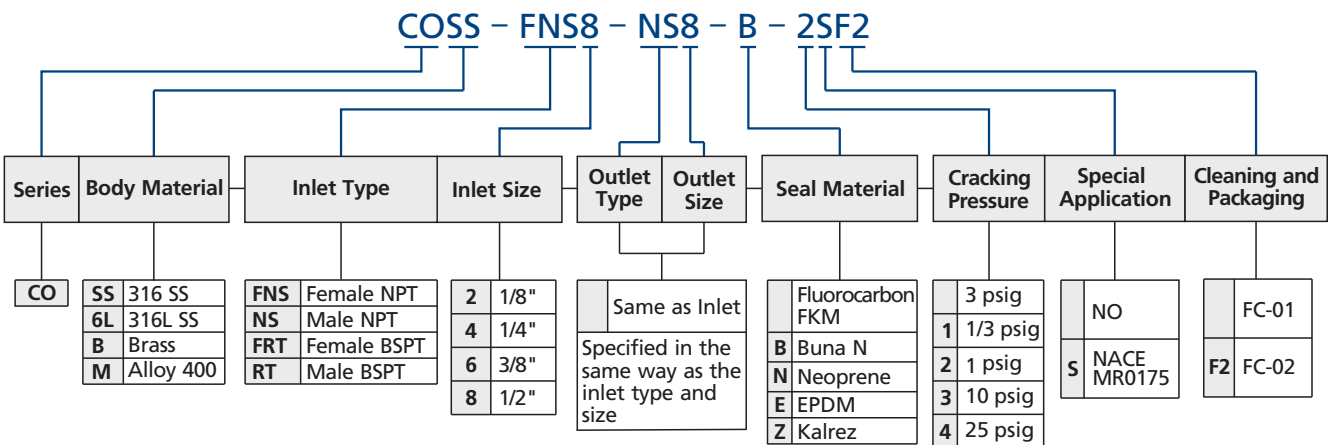

- For oxygen-enriched environment or hazardous media service, please contact FITOK Group or our authorized distributors.
- Cleaning and Packaging:
 FC-01: Standard cleaning and packaging for general industrial procedures.
 FC-02: Special cleaning and packaging for wetted system components to ensure compliance with product cleanliness requirement of ASTM G93 Level C.
- The materials, connection types and sizes listed in the "Ordering Number Description" are standard. For other materials and end connections, please contact FITOK Group or our authorized distributors.
- Check valve is designed with unidirectional flow path, it can't be used as safety relief valve.
- If the check valve is not opened for a period of time, its initial cracking pressure may be higher than set cracking pressure.

CA Series

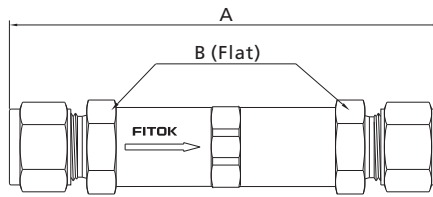

Basic Ordering Number	Connection Type and Size		Cv	Dimensions, in. (mm)	
	Inlet	Outlet		A	B
CA □□ -FL4-	1/4" FITOK	1/4" FITOK	0.37	3.23 (82.0)	5/8 (15.9)
CA □□ -ML6-	6 mm FITOK	6 mm FITOK		3.32 (84.3)	
CA □□ -ML8-	8 mm FITOK	8 mm FITOK		3.09 (78.5)	
CA □□ -FR4-	1/4" Male FR	1/4" Male FR			

Ordering Number Description

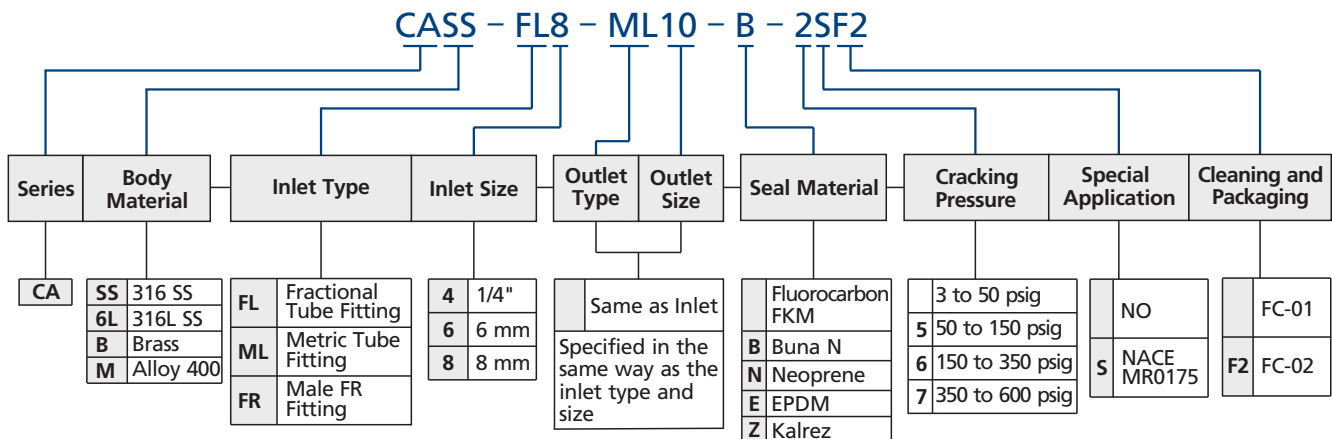

Check Valves
Relief Valves

- For oxygen-enriched environment or hazardous media service, please contact FITOK Group or our authorized distributors.
- Cleaning and Packaging:
 FC-01: Standard cleaning and packaging for general industrial procedures.
 FC-02: Special cleaning and packaging for wetted system components to ensure compliance with product cleanliness requirement of ASTM G93 Level C.
- The materials, connection types and sizes listed in the "Ordering Number Description" are standard. For other materials and end connections, please contact FITOK Group or our authorized distributors.
- Check valve is designed with unidirectional flow path, it can't be used as safety relief valve.
- If the check valve is not opened for a period of time, its initial cracking pressure may be higher than set cracking pressure.

COA Series

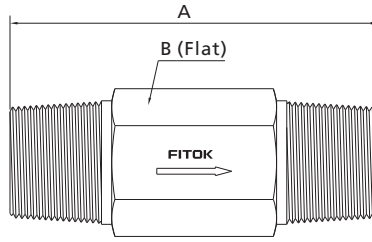

Basic Ordering Number	Connection Type and Size		CV	Dimensions, in. (mm)	
	Inlet	Outlet		A	B
COA □□ -FNS4-	1/4 Female NPT	1/4 Female NPT	0.35	2.98 (75.7)	3/4 (19.1)
COA □□ -NS4-	1/4 Male NPT	1/4 Male NPT	0.35	1.62 (41.1)	9/16 (14.3)
COA □□ -NS8-	1/2 Male NPT	1/2 Male NPT	1.20	2.56 (65.0)	7/8 (22.2)
COA □□ -RT4-	1/4 Male BSPT	1/4 Male BSPT	0.35	1.62 (41.1)	9/16 (14.3)
COA □□ -RT8-	1/2 Male BSPT	1/2 Male BSPT	1.20	2.56 (65.0)	7/8 (22.2)

Ordering Number Description

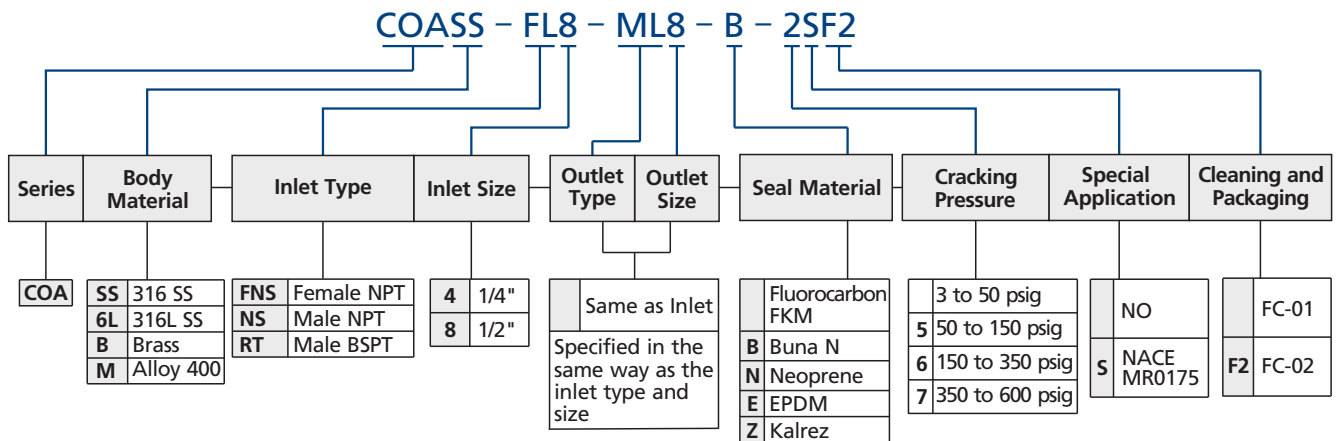

- For oxygen-enriched environment or hazardous media service, please contact FITOK Group or our authorized distributors.
- Cleaning and Packaging:
 FC-01: Standard cleaning and packaging for general industrial procedures.
 FC-02: Special cleaning and packaging for wetted system components to ensure compliance with product cleanliness requirement of ASTM G93 Level C.
- The materials, connection types and sizes listed in the "Ordering Number Description" are standard. For other materials and end connections, please contact FITOK Group or our authorized distributors.
- Check valve is designed with unidirectional flow path, it can't be used as safety relief valve.
- If the check valve is not opened for a period of time, its initial cracking pressure may be higher than set cracking pressure.

CL Series

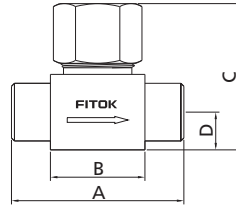

Basic Ordering Number	Connection Type and Size		CV	Dimensions, in. (mm)			
	Inlet	Outlet		A	B	C	D
CL□□-FL4	1/4" FITOK	1/4" FITOK	0.30	2.40 (61.0)	1.01 (25.7)	1.47 (37.3)	0.39 (9.9)
CL□□-FL6	3/8" FITOK	3/8" FITOK	0.64	2.83 (71.9)	1.31 (33.3)	1.85 (47.0)	0.50 (12.7)
CL□□-FL8	1/2" FITOK	1/2" FITOK	2.20	3.92 (99.6)	2.19 (55.6)	2.44 (62.0)	0.62 (15.7)
CL□□-FL12	3/4" FITOK	3/4" FITOK					
CL□□-ML6	6 mm FITOK	6 mm FITOK	0.30	2.40 (61.0)	1.01 (25.7)	1.47 (37.3)	0.39 (9.9)
CL□□-FNS2	1/8 Female NPT	1/8 Female NPT					
CL□□-FNS4	1/4 Female NPT	1/4 Female NPT	0.64	2.25 (57.2)	1.25 (31.8)	1.85 (47.0)	0.50 (12.7)
CL□□-FNS6	3/8 Female NPT	3/8 Female NPT	2.20	3.12 (79.2)	1.86 (47.2)	2.44 (62.0)	0.62 (15.7)
CL□□-FNS8	1/2 Female NPT	1/2 Female NPT					
CL□□-TS4	1/4" TS	1/4" TS	0.30	1.81 (46.0)	0.90 (22.9)	1.47 (37.3)	0.39 (9.9)
CL□□-TS6	3/8" TS	3/8" TS	0.64	2.25 (57.2)	1.25 (31.8)	1.85 (47.0)	0.50 (12.7)
CL□□-TS8	1/2" TS	1/2" TS	2.20	3.13 (79.5)	1.88 (47.8)	2.44 (47.0)	0.62 (15.7)
CL□□-PB4	1/4 PB	1/4 PB	0.30	1.81 (46.0)	0.90 (22.9)	1.47 (37.3)	0.39 (9.9)
CL□□-PB6	3/8 PB	3/8 PB	0.64	2.25 (57.2)	1.25 (31.8)	1.85 (47.0)	0.50 (12.7)
CL□□-PB8	1/2 PB	1/2 PB	2.20	3.13 (79.5)	1.88 (47.8)	2.44 (62.0)	0.62 (15.7)

Ordering Number Description

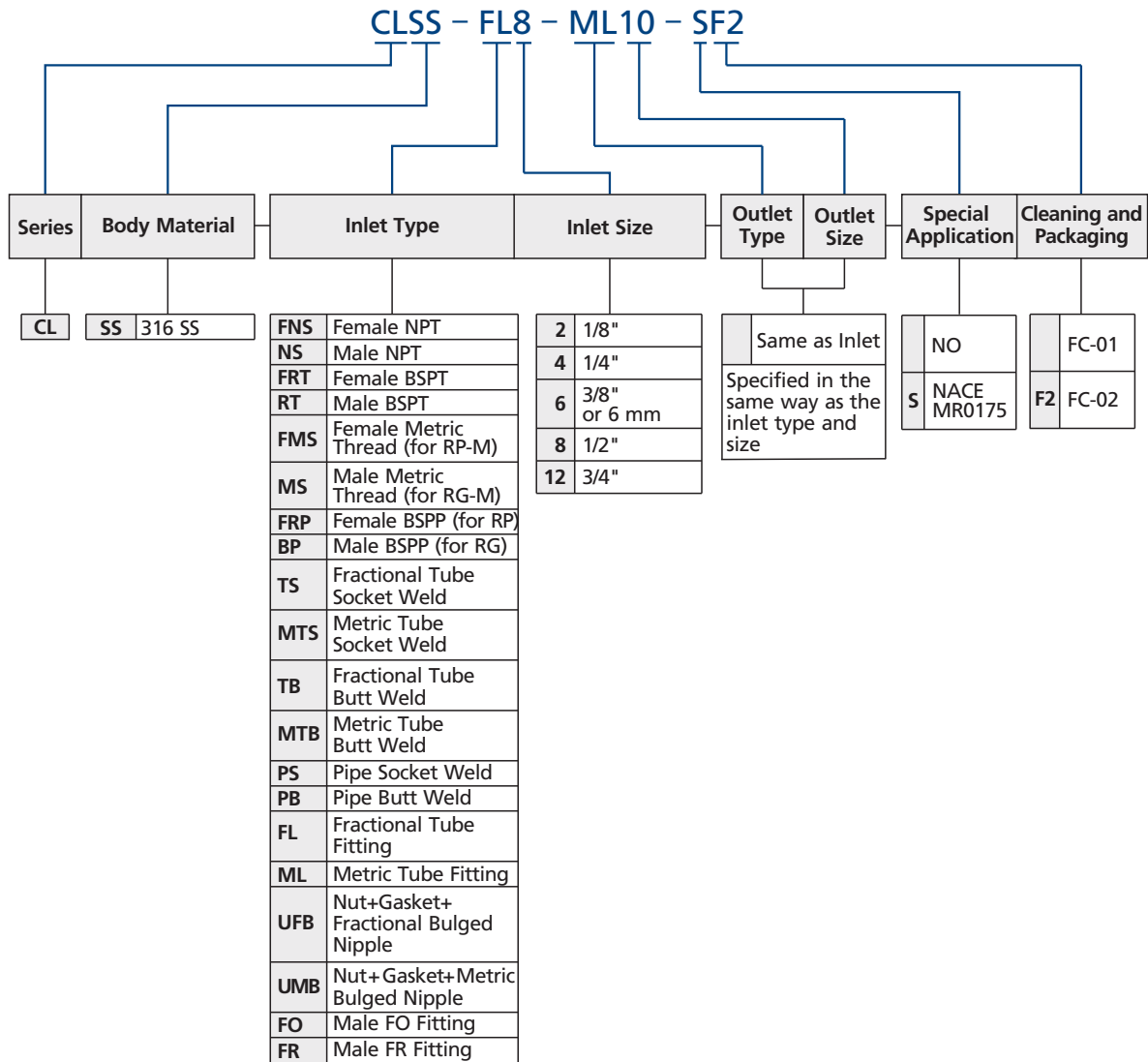

1. Standard thread pitch for metric threads are as follows:
 M10 and below: 1 mm
 M12 to M24: 1.5 mm
 M27 and above: 2 mm
 Standard thread pitch should be omitted in the ordering number, others should be specified.
2. For oxygen-enriched environment or hazardous media service, please contact FITOK Group or our authorized distributors.
3. Cleaning and Packaging:
 FC-01: Standard cleaning and packaging for general industrial procedures.
 FC-02: Special cleaning and packaging for wetted system components to ensure compliance with product cleanliness requirement of ASTM G93 Level C.
4. The materials, connection types and sizes listed in the "Ordering Number Description" are standard. For other materials and end connections, please contact FITOK Group or our authorized distributors.

CW Series

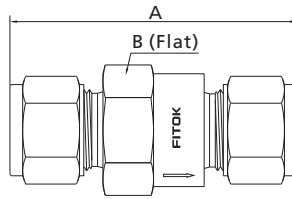

Basic Ordering Number	Connection Type and Size		Cv	Dimensions, in. (mm)	
	Inlet	Outlet		A	B
CW□□-TB4	1/4" TB	1/4" TB	0.55	1.24 (31.5)	7/8 (22.23)
CW□□-TB6	3/8" TB	3/8" TB	0.70		
CW□□-TB8	1/2" TB	1/2" TB	0.55		
CW□□-MTB6	6 mm MTB	6 mm MTB	0.55	1.80 (45.7)	
CW□□-FR4	1/4" Male FR	1/4" Male FR	0.70	2.06 (52.3)	1 (25.4)
CW□□-FR8	1/2" Male FR	1/2" Male FR	0.70		
CW□□-FL4	1/4" FITOK	1/4" FITOK	0.55	1.96 (49.8)	7/8 (22.23)
CW□□-ML6	6 mm FITOK	6 mm FITOK	0.55		

Ordering Number Description

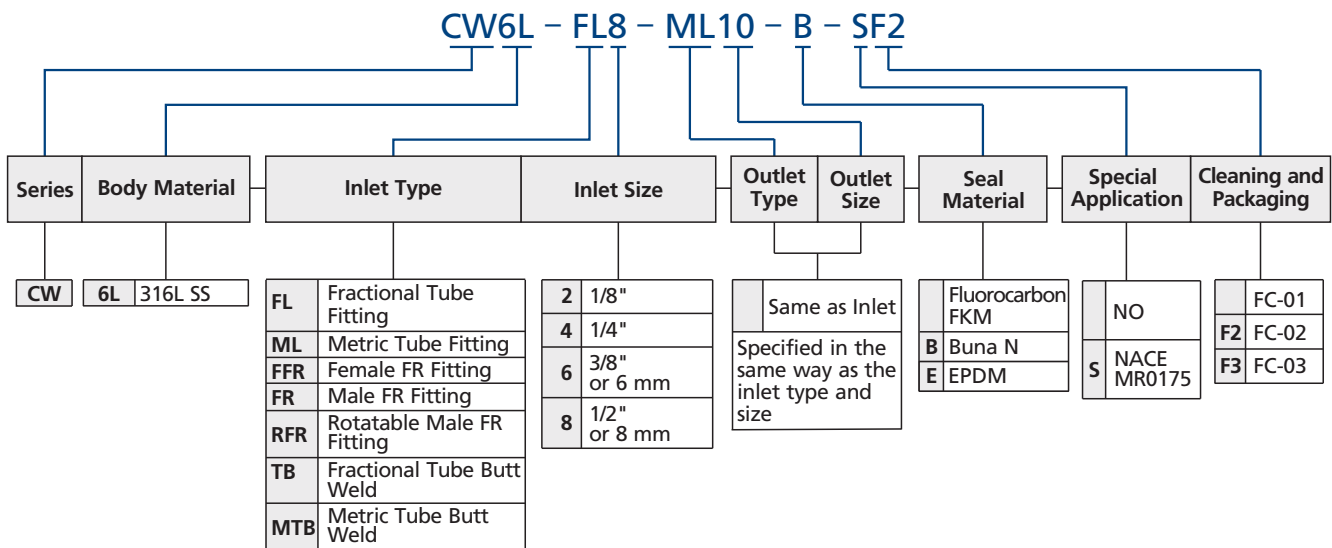

- For oxygen-enriched environment or hazardous media service, please contact FITOK Group or our authorized distributors.
- Cleaning and Packaging:
 - FC-01: Standard cleaning and packaging for general industrial procedures.
 - FC-02: Special Cleaning and packaging is applied to wetted system assembly with its surface roughness finished to an average of Ra 0.5 µm after machine polishing to meet the requirement of ASTM G93 Level C.
 - FC-03: Ultrahigh-purity Cleaning and Packaging is applied to wetted system assembly with its surface roughness finished to an average of Ra 0.2 µm after machine polishing and electropolishing.
- The materials, connection types and sizes listed in the "Ordering Number Description" are standard. For other materials and end connections, please contact FITOK Group or our authorized distributors.
- Check valve is designed with unidirectional flow path, it can't be used as safety relief valve.
- If the check valve is not opened for a period of time, its initial cracking pressure may be higher than set cracking pressure.

Check Valves Relief Valves

FITOK Group

FITOK GmbH (Headquarter)

Sprendlinger Landstr. 115, 63069 Offenbach am Main, Germany
Tel.: +49 69 8900 4498 Fax: +49 69 8900 4495

FITOK, Inc.

13843 North Promenade Blvd., Suite 750, Stafford, Texas 77477, USA
Tel.: +1 281 888 0077 Fax: +1 281 582 4051

FITOK Incorporated

Block C, Zone E, Yingtai Industrial Park, Dalang Street,
Longhua New District, Shenzhen, 518109, China
Tel.: +86 755 2803 2500 Fax: +86 755 2803 2619

FITOK Middle East Oil Equipment Trading LLC

208-209, Makateb Building, Airport Road, P.O.Box 185412, Deira, Dubai, UAE
Tel.: +971 4 2959 853 Fax: +971 4 2959 854

info@fitokgroup.com
www.fitokgroup.com

FK-IC-GV-02-EN-170516