

Domestic consumer unit enclosures series TOPO IP40



BK080102



BK080152



BK080053



BK080001



BK080050



Schrack-Info

- Wall- and flush-mounted domestic consumer unit enclosures in ABS with transparent or solid plastic doors
- Lock: push-button, a small cylinder can be installed
- Includes PE and N terminals
- Protection class II
- Rated voltage 400VAC / In=63A
- Ambient temperature: -25° to +60°C
- Glow wire test: 650°C
- Recess depth: 68-70mm
- Degree of protection: IP40, Impact resistance: IK08
- RAL9010 pure white

Domestic consumer unit enclosures series TOPO IP40

Dimensions wall-mounted enclosure

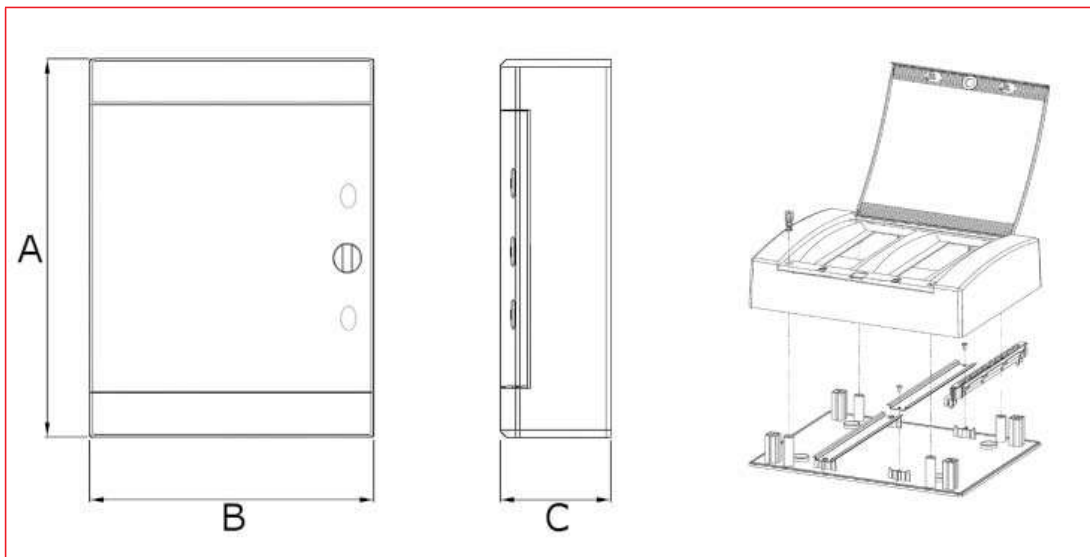

Article number		A [mm]	B [mm]	C [mm]	Rows	MW	Radiant power loss [W]*
with trans- parent door	with white door						
BK080100	BK080150	236	215	102	1	8	-14
BK080101	BK080151	236	287	112	1	12	-22
BK080104	BK080154	236	396	112	1	18	-22
BK080102	BK080152	361	287	112	2	24	-24
BK080106	BK080156	361	396	112	2	36	-25
BK080103	BK080153	526	287	112	3	36	-26
BK080105	BK080155	652	287	112	4	48	-28
BK080107	BK080157	526	396	112	3	54	-29

*Max. radiated power of housing calculated as a wall-mounted single fixed with $\Delta T = 35K$.

Detailed information and legal notes see page 268

Dimensions flush-mounted enclosure

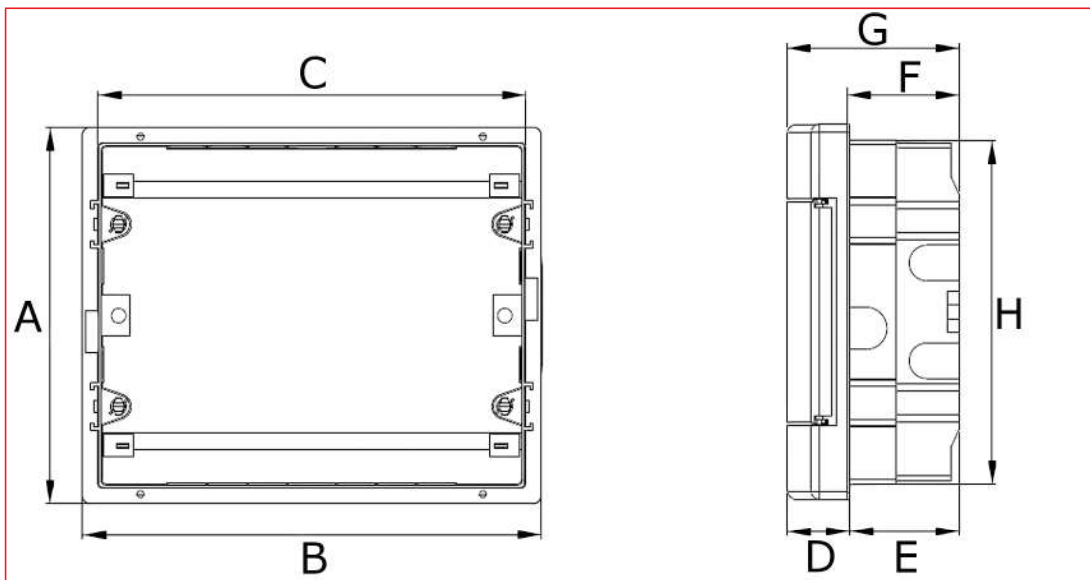









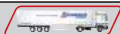

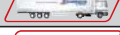



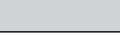
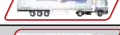
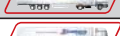











Article number		A [mm]	B [mm]	C [mm]	D [mm]	E [mm]	F [mm]	G [mm]	H [mm]	Rows	MW	Radiant power loss [W]*
with trans- parent door	with white door											
BK080000	BK080050	232	211	191	31	68	70	99	212	1	8	-14
BK080001	BK080051	232	283	273	38	68	70	106	212	1	12	-22
BK080004	BK080054	232	392	373	38	68	70	106	212	1	18	-23
BK080002	BK080052	357	283	273	38	68	70	106	336	2	24	-24
BK080006	BK080056	357	392	373	38	68	70	106	336	2	36	-25
BK080003	BK080053	482	283	273	38	68	70	106	460	3	36	-26
BK080007	BK080057	522	392	373	38	68	70	106	502	4	48	-29

*Max. radiated power of housing calculated as a flush-mounted single fixed with $\Delta T = 35K$.

Detailed information and legal notes see page 268

Domestic consumer unit enclosures series TOPO IP40

DESCRIPTION	WxHxD mm	AVAILABLE	ORDER NO.
Wall-mounted with transparent door			
1-row, 8MW	215x236x102		BK080100
1-row, 12MW	287x236x112		BK080101
1-row, 18MW	396x236x112		BK080104
2-rows, 24MW	287x361x112		BK080102
2-rows, 36MW	396x361x112		BK080106
3-rows, 36MW	287x526x112		BK080103
4-rows, 48MW	287x652x112		BK080105
3-rows, 54MW	396x526x112		BK080107
Wall-mounted with white door			
1-row, 8MW	215x236x102		BK080150
1-row, 12MW	287x236x112		BK080151
1-row, 18MW	396x236x112		BK080154
2-rows, 24MW	287x361x112		BK080152
2-rows, 36MW	396x361x112		BK080156
3-rows, 36MW	287x526x112		BK080153
4-rows, 48MW	287x652x112		BK080155
3-rows, 54MW	396x526x112		BK080157
Flush-mounted with transparent door			
1-row, 8MW	211x232x99		BK080000
1-row, 12MW	283x232x106		BK080001
1-row, 18MW	392x232x106		BK080004
2-rows, 24MW	283x357x106		BK080002
2-rows, 36MW	392x357x106		BK080006
3-rows, 36MW	283x482x106		BK080003
3-rows, 54MW	392x522x106		BK080007
Flush-mounted with white door			
1-row, 8MW	211x232x99		BK080050
1-row, 12MW	283x232x106		BK080051
1-row, 18MW	392x232x106		BK080054
2-rows, 24MW	283x357x106		BK080052
2-rows, 36MW	392x357x106		BK080056
3-rows, 36MW	283x482x106		BK080053
3-rows, 54MW	392x522x106		BK080057

