

aerospace  
 climate control  
 electromechanical  
 filtration  
 fluid & gas handling  
 hydraulics  
 pneumatics  
 process control  
 sealing & shielding



# ZoomLock® PUSH

**PUSH-TO-CONNECT  
 REFRIGERANT FITTINGS**

## ZoomLock® PUSH Push-to-Connect Refrigerant Fittings

Catalog K-2, Engineering Submittal, February 2021



ENGINEERING YOUR SUCCESS.

## PARKER SAFETY GUIDE FOR SELECTING AND USING ZOOMLOCK FITTINGS AND RELATED ACCESSORIES

# WARNING

**FAILURE TO FOLLOW INSTALLATION INSTRUCTIONS, IMPROPER SELECTION OR IMPROPER USE OF ZOOMLOCK FITTINGS AND RELATED ACCESSORIES (“PRODUCTS”) CAN CAUSE DEATH, PERSONAL INJURY AND PROPERTY DAMAGE. POSSIBLE CONSEQUENCES OF FAILURE, IMPROPER SELECTION OR IMPROPER USE OF THESE PRODUCTS INCLUDE BUT ARE NOT LIMITED TO:**

- Fittings thrown off at high speed.
- High velocity fluid discharge.
- Explosion or burning of the conveyed fluid.
- Electrocution from high voltage electric power lines.
- Contact with suddenly moving or falling objects that are controlled by the conveyed fluid.
- Injections by high-pressure fluid discharge.
- Dangerously whipping copper line.
- Contact with conveyed fluids that may be hot, cold, toxic or otherwise injurious.
- Sparking or explosion caused by static electricity buildup or other sources of electricity.
- Sparking or explosion from flammable liquids.

**BEFORE SELECTING OR USING ANY OF THESE PRODUCTS, IT IS IMPORTANT THAT YOU READ AND FOLLOW THE INSTALLATION INSTRUCTIONS.**

## KEY STEPS FOR SAFETY

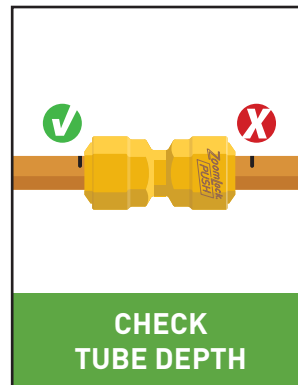
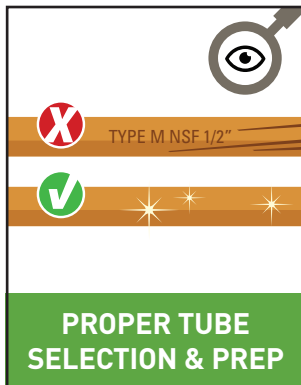

### **⚠️WARNING – USER RESPONSIBILITY**

**Failure or improper selection or improper use of the products described herein or related items can cause death, personal injury and property damage.**

This document and other information from Parker Hannifin Corporation, its subsidiaries and authorized distributors provide product or system options for further investigation by users having technical expertise.

The user, through its own analysis and testing, is solely responsible for making the final selection of the system and components and assuring that all performance, endurance, maintenance, safety and warning requirements of the application are met. The user must analyze all aspects of the application, follow applicable industry standards, and follow the information concerning the product in the current product catalog and in any other materials provided from Parker or its subsidiaries or authorized distributors.

To the extent that Parker or its subsidiaries or authorized distributors provide component or system options based upon data or specifications provided by the user, the user is responsible for determining that such data and specifications are suitable and sufficient for all applications and reasonably foreseeable uses of the components or systems.

For safety information see the Safety Guide at [www.parker.com/safety](http://www.parker.com/safety) or call 1-800-CParker.

### **OFFER OF SALE**

The items described in this document are hereby offered for sale by Parker Hannifin Corporation, its subsidiaries or its authorized distributors. This offer and its acceptance are governed by the provisions stated in the detailed “Offer of Sale” elsewhere in this document or available at [www.parker.com](http://www.parker.com).

# ZoomLock **PUSH**

## Push-to-Connect Refrigerant Fittings

### TABLE OF CONTENTS

Introduction .....	4
Push-to-Connect Refrigerant Fittings	
Couplings	
R410A Optimized .....	6
Removable .....	6
Elbows - 90°	
R410A Optimized .....	7
Removable .....	7
SAE Flare Reducers	
R410A Optimized .....	8
Removable .....	8
Installation of Fitting .....	9
Removal of Fitting .....	10
Installation Parts and Accessories .....	11
Terms of Sale with Warranty Limitations .....	12



### Compatible Components

To make a system convenient to install, ODM x ODM ZoomLock compatible components are available including:

- » Ball Valves
- » Moisture and Liquid Indicators
- » Solenoid Valves
- » Filter-Driers



### ATTENTION!

WARRANTY COULD BE VOID IF ZOOMLOCK PUSH IS NOT APPLIED PER INSTRUCTIONS! CAREFULLY READ ALL INSTALLATION INSTRUCTIONS (SEE PAGE 9) AND WATCH VIDEOS.



ZoomLockPUSH.com



*Connect Copper with a Simple PUSH!*

**ZoomLock®**  
**PUSH**

## **PUSH-TO-CONNECT REFRIGERANT FITTINGS**

HVAC/R pros know that time is money. ZoomLock® PUSH push-to-connect refrigerant fittings allow contractors to successfully make clean, leak-free



connections on HVAC/R systems in seconds, without the use of a brazing torch or press tool and jaw.

ZoomLock PUSH fittings eliminate brazing, flames, fire spotters, and the risks associated with installation of traditional HVAC/R fittings.

ZoomLock PUSH fittings offer a way for contractors to connect refrigerant lines in seconds, boosting efficiency while providing the safety and reliability you expect from Parker.

### **The ZoomLock PUSH Advantage**

- » No press tool or jaws needed
- » Fast and easy install
- » Cleaner system installs
- » Secure, leak-free connections
- » Safer conditions, no fire hazards
- » No hot-work permits
- » No need to nitrogen-purge
- » Flexible access to job sites

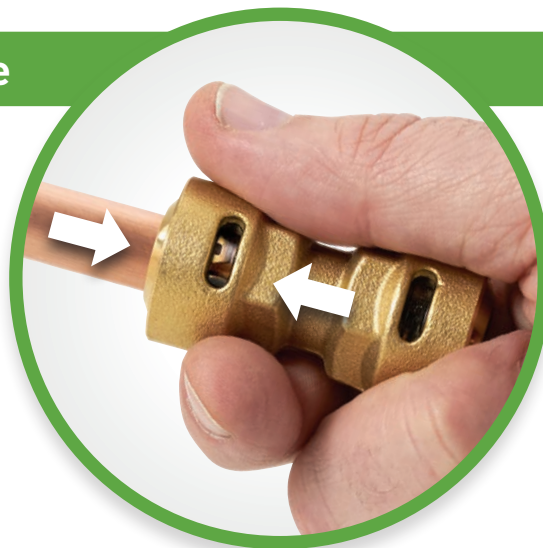

**HELPING YOUR BUSINESS WIN MORE BUSINESS™**



# ZoomLock PUSH

## Push-to-Connect Refrigerant Fittings



### Applications

- » High Pressure HVAC/R

### Product Parameters

- » **Continuous Operating Temperature:**  
250°F / 121°C
- » **O-Ring Temperature Rating:**  
-40°F to +300°F  
-40°C to +149°C
- » **Maximum Rated Pressure (MRP):**  
870 psig / 60 bar
- » **Minimum Burst Pressure (UL 207):**  
4,355 psig / 300 bar
- » **Vacuum Pressure Capability:**  
200 Microns
- » **External Leak Rate:**  
<0.1 Ounces of Helium per Year at Operating Pressure Range
- » **Vibration Resistance:**  
Conforms to UL109
- » **Size Availability (Inches):**  
1/4, 3/8, 1/2, 5/8, 3/4, 7/8

### Fitting Materials

- » **Fitting Body:**  
Brass
- » **O-Ring:**  
R410A Optimized: HNBR  
Removable: Chloroprene

### Compatibility

- » **Approved Lubricants:** POE, PVE
- » **Approved Tubing Materials:**  
Copper to Copper Connections
- » **Approved Tubing Tolerance:**  
ASTM B280, UNI EN 12735
- » **Approved Copper Tubing Types:**  
Hard Copper (Drawn)  
- 1/4" - 7/8" Type ACR, M, L, K  
Soft Copper (Annealed)  
- 1/4" - 7/8" Type ACR, L, K

### Agency Approvals and Certifications

- » UL Listed SA7511  
Approved use for field and factory installations
- » ASHRAE-15, ANSI 15, ASME B31.5, ANSI 31.5

### Fitting Warranty

- » Read page 12 for more details.

### Approved Refrigerants

Refrigerant	R410A Optimized Fittings	Removable Fittings
R22	—	✓
R32	✓	✓
R134a	✓	✓
R290	✓	✓
R404A	✓	✓
R407A	✓	✓
R407C	✓	✓
R407F	✓	✓
R410A	✓	✓
R448A	✓	✓
R449A	✓	✓
R454B	✓	✓
R507	✓	✓

Refer to ZoomLockPUSH.com for the latest approved refrigerants list.

# ZoomLock PUSH

## Push-to-Connect Refrigerant Fittings

### COUPLINGS

#### R410A OPTIMIZED



#### REMOVABLE



Size (Inches)	Part Number	Description	Dimensions					
			A		B		C	
			Inch	mm	Inch	mm	Inch	mm
1/4	777100	PZKP-C4-HNBR	0.26	6.65	1.89	48	0.79	20
3/8	777101	PZKP-C6-HNBR	0.38	9.70	1.97	50	0.95	24
1/2	777102	PZKP-C8-HNBR	0.51	13.0	2.13	54	1.06	27
5/8	777103	PZKP-C10-HNBR	0.64	16.2	2.24	57	1.18	30
3/4	777104	PZKP-C12-HNBR	0.76	19.3	2.58	65.5	1.46	37
7/8	777105	PZKP-C14-HNBR	0.89	22.5	2.62	66.5	1.57	40

Size (Inches)	Part Number	Description	Dimensions					
			A		B		C	
			Inch	mm	Inch	mm	Inch	mm
1/4	777133	PZKPR-C4	0.26	6.65	1.89	48	0.79	20
3/8	777134	PZKPR-C6	0.38	9.70	1.97	50	0.95	24
1/2	777135	PZKPR-C8	0.51	13.0	2.13	54	1.06	27
5/8	777136	PZKPR-C10	0.64	16.2	2.24	57	1.18	30
3/4	777137	PZKPR-C12	0.77	19.5	2.58	65.5	1.46	37
7/8	777138	PZKPR-C14	0.89	22.6	2.62	66.5	1.57	40

### Dimensions

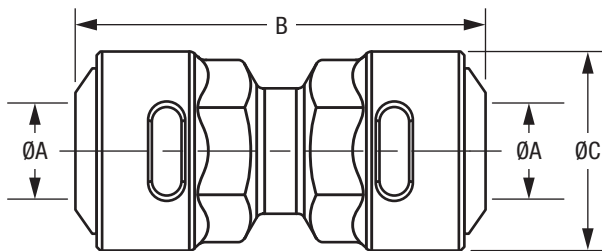

### Dimensions

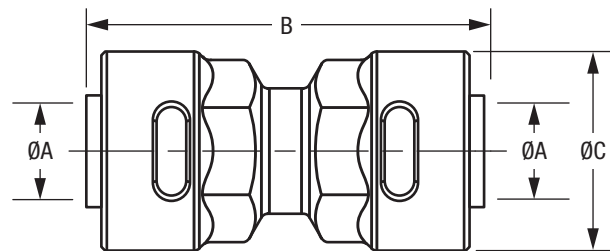

# ZoomLock **PUSH**

## Push-to-Connect Refrigerant Fittings

### ELBOWS - 90 degree

#### R410A OPTIMIZED



#### REMOVABLE



Size (Inches)	Part Number	Description	Dimensions					
			A		B		C	
			Inch	mm	Inch	mm	Inch	mm
1/4	777110	PZKP-90E4-HNBR	0.26	6.65	1.16	29.5	0.79	20
3/8	777111	PZKP-90E6-HNBR	0.38	9.70	1.26	32	0.95	24
1/2	777112	PZKP-90E8-HNBR	0.51	13.0	1.42	36	1.06	27
5/8	777113	PZKP-90E10-HNBR	0.64	16.2	1.54	39	1.18	30
3/4	777114	PZKP-90E12-HNBR	0.76	19.3	1.73	44	1.46	37
7/8	777115	PZKP-90E14-HNBR	0.89	22.5	1.77	45	1.57	40

Size (Inches)	Part Number	Description	Dimensions					
			A		B		C	
			Inch	mm	Inch	mm	Inch	mm
1/4	777143	PZKPR-90E4	0.26	6.65	1.16	29.5	0.79	20
3/8	777144	PZKPR-90E6	0.38	9.70	1.26	32	0.95	24
1/2	777145	PZKPR-90E8	0.51	13.0	1.42	36	1.06	27
5/8	777146	PZKPR-90E10	0.64	16.2	1.54	39	1.18	30
3/4	777147	PZKPR-90E12	0.77	19.5	1.73	44	1.46	37
7/8	777148	PZKPR-90E14	0.89	22.6	1.77	45	1.57	40

### Dimensions

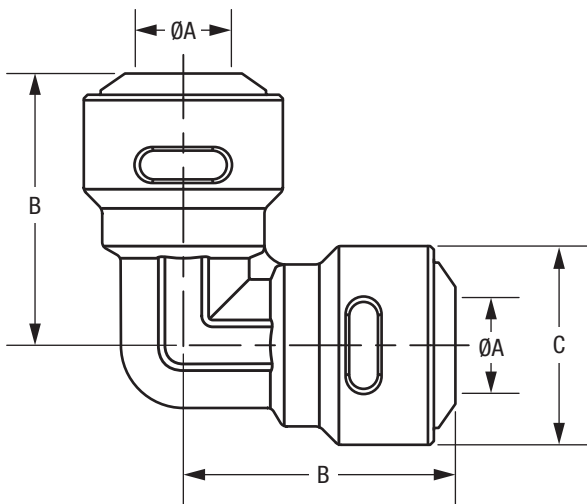

### Dimensions

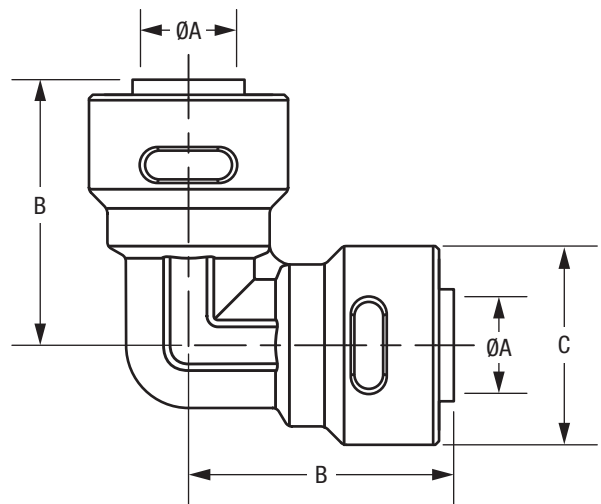

# ZoomLock PUSH

## Push-to-Connect Refrigerant Fittings

### SAE FLARE ADAPTERS

#### R410A OPTIMIZED



#### REMOVABLE



Size Inches	Part Number	Description	Dimensions						SAE Threads (UNF)
			A		B		C		
			Inch	mm	Inch	mm	Inch	mm	
1/4	777106	PZKP-F4-HNBR	0.26	6.65	1.52	38.5	0.67	17	7/16-20
3/8	777107	PZKP-F6-HNBR	0.38	9.70	1.63	41.5	0.87	22	5/8-18
1/2	777108	PZKP-F8-HNBR	0.51	13.0	1.83	46.5	0.95	24	3/4-16
5/8	777109	PZKP-F10-HNBR	0.64	16.2	2.09	53	1.06	27	7/8-14

Size Inches	Part Number	Description	Dimensions						SAE Threads (UNF)
			A		B		C		
			Inch	mm	Inch	mm	Inch	mm	
1/4	777139	PZKPR-F4	0.26	6.65	1.52	38.5	0.67	17	7/16-20
3/8	777140	PZKPR-F6	0.38	9.70	1.63	41.5	0.87	22	5/8-18
1/2	777141	PZKPR-F8	0.51	13.0	1.83	46.5	0.95	24	3/4-16
5/8	777142	PZKPR-F10	0.64	16.2	2.09	53	1.06	27	7/8-14

#### Dimensions

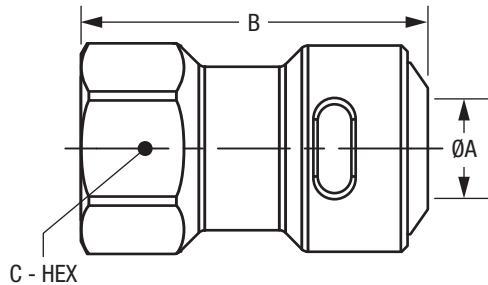

#### Dimensions

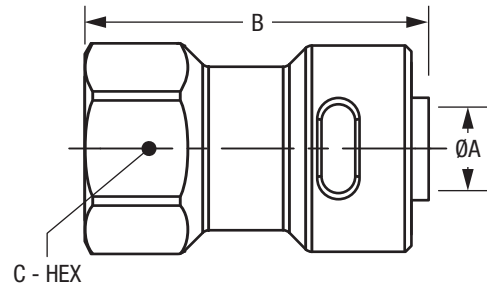



# ZoomLock **PUSH**

## Push-to-Connect Refrigerant Fittings

### INSTALLATION OF FITTING

**⚠ CAUTION:** Do not insert fingers in to the grip ring inside the fitting. Immediate emergency medical attention may be required for removal.

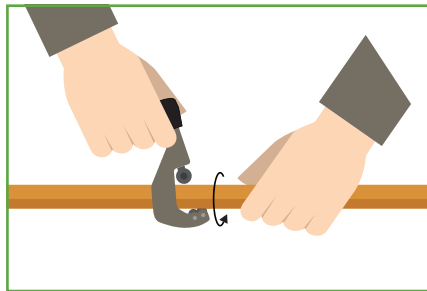

#### STEP 1 - CUT COPPER TUBE

Cut copper tube using a commercially available tube cutter. Verify tube cutter is properly maintained and wheel is sharp. **DO NOT** use any type of saw as this creates a sharp surface that will cut the o-ring.

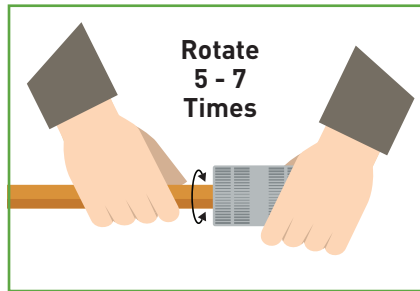

#### STEP 2 - DEBURR

**ALL tubing MUST** have the outer diameter **deburred** prior to ZoomLock PUSH fitting installation. Rotate tool back-and-forth 5 - 7 times to remove all sharp edges and burrs. **Perform this step BEFORE sanding.**

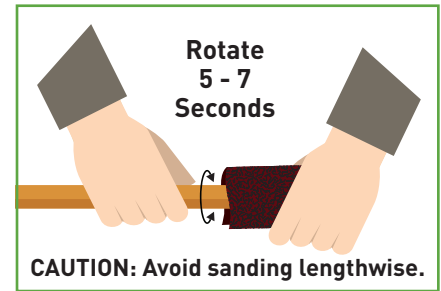

#### STEP 3 - SAND and CLEAN

**ALL tubing must be SANDED and CLEANED.** Use a general purpose hand pad or sand cloth. **SAND tube in RADIAL DIRECTION** as shown with arrows for 5 - 7 seconds or 10 - 14 times back-and-forth. Remove residual debris from tube end.

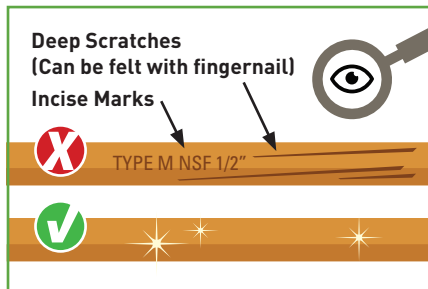

#### STEP 4 - INSPECT TUBE

**INSPECT copper tube AFTER sanding.** Assure there are **NO VISIBLE SCRATCHES, INCISE MARKS, TUBE DEFECTS OR TUBE OUT OF ROUND.**

Area of importance is within 1½ inches from tube end. If scratches are present, cut off affected areas and repeat Steps 2 and 3 or sand thoroughly to remove.

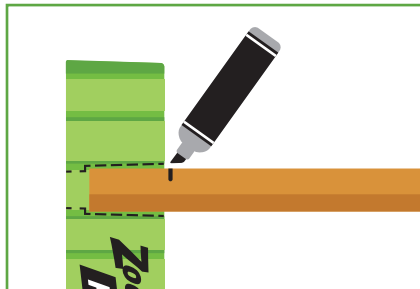

#### STEP 5 - MARK DEPTH

Using the depth gauge (provided in the ZoomLock PUSH Installation Kit, P/N 777091) or Table 2 Insertion Depths, to determine the correct insertion depth. Mark the tubing with a permanent marker to indicate proper insertion depth on every tube.

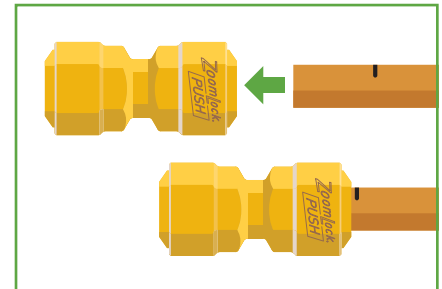

#### STEP 6 - PUSH INTO FITTING

Push the tube into the fitting. Use the mark to assure insertion depth and secure fit.

# ZoomLock **PUSH**

## Push-to-Connect Refrigerant Fittings

### INSTALLATION OF FITTING (Continued)

#### EQUIVALENT LENGTH\*

Table 1

Tube Diameter	Equivalent Length	
	Feet	cm
1/4"	1.4	42.7
3/8"	1.4	42.7
1/2"	1.6	48.8
5/8"	1.8	54.9
3/4"	2.0	61.0
7/8"	2.3	70.1

ZoomLock PUSH elbows have an internal profile such that the pressure drop is less than a standard ACR short radius elbow (R/D = 1), but more than a standard ACR long radius elbow (R/D = 1.5).

For installations where pressure drop is of particular concern, use the standard equivalent length for a short radius elbow for a conservative calculation (reference table 1).

\*ASHRAE Handbook Refrigeration, Chapter 1, 2018, American Society of Heating, Refrigerating, and Air-Conditioning Engineers, [www.ashrae.org](http://www.ashrae.org)

#### INSERTION DEPTHS

For both R410A Optimized and Removable Fittings

Table 2

Tube Diameter	Insertion Depth	
	Inches	mm
1/4"	0.87	22.1
3/8"	0.91	23.1
1/2"	0.99	25.1
5/8"	1.06	26.9
3/4"	1.19	30.2
7/8"	1.25	31.8

### REMOVAL OF FITTING (Removable Fittings Only)

**⚠ CAUTION:** Removal of fittings while system is under pressure can result in serious injury.

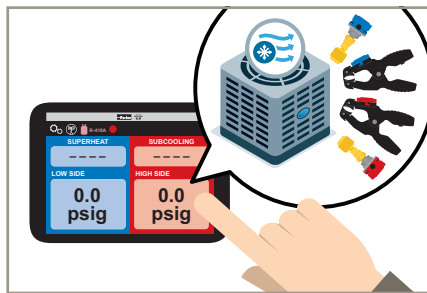

**STEP 1 - ISOLATE OR REMOVE SYSTEM CHARGE**

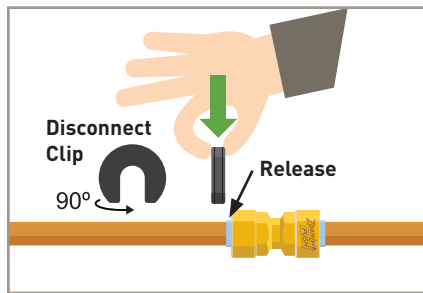

**STEP 2 - INSERT CLIP**

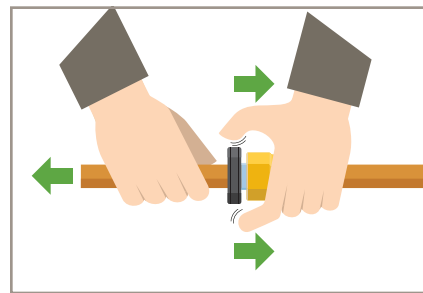

**STEP 3 - PRESS RELEASE**

**NOTE:**

1. ZoomLock PUSH Removable fittings are not designed for repeated reinstallations. Observing the removal instructions above, the fittings can be removed.
2. Care should be taken when connecting copper tubing to avoid using damaged copper or fittings.
3. Fittings and linesets should be inspected with other components during routine annual maintenance checks.

# ZoomLock **PUSH**

## Push-to-Connect Refrigerant Fittings

### INSTALLATION PARTS and ACCESSORIES



#### Installation Kit

3 piece ZoomLock PUSH installation kit includes depth gauge, permanent marker, and Scotch-Brite® general purpose hand pad. Tubing cutter and deburring tool sold separately.

- » **Description:** PZKP-IK
- » **Part Number:** 777091



#### Removal Tools

Removal tools for 1/4" - 7/8" sizes of ZoomLock PUSH removable fittings.

- » **Description:** PZKPR-RT
- » **Part Number:** 777090

## PARKER-HANNIFIN CORPORATION OFFER OF SALE

### 1. **Definitions.** As used herein, the following terms have the meanings indicated.

Buyer: means any customer receiving a Quote for Products.

Goods: means any tangible part, system or component to be supplied by Seller.

Products: means the Goods, Services and/or Software as described in a Quote.

Quote: means the offer or proposal made by Seller to Buyer for the supply of Products.

Seller: means Parker-Hannifin Corporation, including all divisions and businesses thereof.

Services: means any services to be provided by Seller.

Software: means any software related to the Goods, whether embedded or separately downloaded.

Terms: means the terms and conditions of this Offer of Sale.

**2. Terms.** All sales of Products by Seller are expressly conditioned upon, and will be governed by the acceptance of, these Terms. These Terms are incorporated into any Quote provided by Seller to Buyer. Buyer's order for any Products whether communicated to Seller verbally, in writing, by electronic data interface or other electronic commerce, shall constitute acceptance of these Terms. Seller objects to any contrary or additional terms or conditions of Buyer. Reference in Seller's order acknowledgement to Buyer's purchase order or purchase order number shall in no way constitute an acceptance of any of Buyer's terms or conditions of purchase. No modification to these Terms will be binding on Seller unless agreed to in writing and signed by an authorized representative of Seller.

**3. Price; Payment.** The Products set forth in the Quote are offered for sale at the prices indicated in the Quote. Unless otherwise specifically stated in the Quote, prices are valid for thirty (30) days and do not include any sales, use, or other taxes or duties. Seller reserves the right to modify prices at any time to adjust for any raw material price fluctuations. Unless otherwise specified by Seller, all prices are F.C.A. Seller's facility (INCOTERMS 2020). All sales are contingent upon credit approval and full payment for all purchases is due thirty (30) days from the date of invoice (or such date as may be specified in the Quote). Unpaid invoices beyond the specified payment date incur interest at the rate of 1.5% per month or the maximum allowable rate under applicable law.

**4. Shipment; Delivery; Title and Risk of Loss.** All delivery dates are approximate, and Seller is not responsible for damages resulting from any delay. Regardless of the manner of shipment, delivery occurs and title and risk of loss or damage pass to Buyer, upon placement of the Products with the carrier at Seller's facility. Unless otherwise agreed prior to shipment and for domestic delivery locations only, Seller will select and arrange, at Buyer's sole expense, the carrier and means of delivery. When Seller selects and arranges the carrier and means of delivery, freight and insurance costs for shipment to the designated delivery location will be prepaid by Seller and added as a separate line item to the invoice. Buyer shall be responsible for any additional shipping charges incurred by Seller due to Buyer's acts or omissions. Buyer shall not return or repackage any Products without the prior written authorization from Seller, and any return shall be at the sole cost and expense of Buyer.

**5. Warranty.** The warranty for the Products is as follows: (i) Goods are warranted against defects in material or workmanship for a period of ten (10) years (R410A Optimized) and five (5) years (Removable) from the date of delivery; (ii) Services shall be performed in accordance with generally accepted practices and using the degree of care and skill that is ordinarily exercised and customary in the field to which the Services pertain and are warranted for a period of six (6) months from the date of completion of the Services; and (iii) Software is only warranted to perform in accordance with applicable specifications provided by Seller to Buyer for ninety (90) days from the date of delivery or, when downloaded by a Buyer or end-user, from the date of the initial download. All prices are based upon the exclusive limited warranty stated above, and upon the following disclaimer: **EXEMPTION CLAUSE; DISCLAIMER OF WARRANTY, CONDITIONS, REPRESENTATIONS: THIS WARRANTY IS THE SOLE AND ENTIRE WARRANTY, CONDITION, AND REPRESENTATION, PERTAINING TO PRODUCTS. SELLER DISCLAIMS ALL OTHER WARRANTIES, CONDITIONS, AND REPRESENTATIONS, WHETHER STATUTORY, EXPRESS OR IMPLIED, INCLUDING BUT NOT LIMITED TO THOSE RELATING TO DESIGN, NONINFRINGEMENT, MERCHANTABILITY, AND FITNESS FOR A PARTICULAR PURPOSE. SELLER DOES NOT WARRANT THAT THE SOFTWARE IS ERROR-FREE OR FAULT-TOLERANT, OR THAT BUYER'S USE THEREOF WILL BE SECURE OR UNINTERRUPTED. UNLESS OTHERWISE AUTHORIZED IN WRITING BY SELLER, THE SOFTWARE SHALL NOT BE USED IN CONNECTION WITH HAZARDOUS OR HIGH RISK ACTIVITIES OR ENVIRONMENTS. EXCEPT AS EXPRESSLY STATED HEREIN, ALL PRODUCTS ARE PROVIDED "AS IS".**

**6. Claims; Commencement of Actions.** Buyer shall promptly inspect all Products upon receipt. No claims for shortages will be allowed unless reported to Seller within ten (10) days of delivery. Buyer shall notify Seller of any alleged breach of warranty within thirty (30) days after the date the non-conformance is or should have been discovered by Buyer. Any claim or action against Seller based upon breach of contract or any other theory, including tort, negligence, or otherwise must be commenced within twelve (12) months from the date of the alleged breach or other alleged event, without regard to the date of discovery.

**7. LIMITATION OF LIABILITY.** IN THE EVENT OF A BREACH OF WARRANTY, SELLER WILL, AT ITS OPTION, REPAIR OR REPLACE THE NON-CONFORMING PRODUCT, RE-PERFORM THE SERVICES, OR REFUND THE PURCHASE PRICE PAID WITHIN A REASONABLE PERIOD OF TIME. **IN NO EVENT IS SELLER LIABLE FOR ANY SPECIAL, INDIRECT, INCIDENTAL OR CONSEQUENTIAL DAMAGES INCLUDING ANY LOSS OF REVENUE OR PROFITS, WHETHER BASED IN CONTRACT, TORT OR OTHER LEGAL THEORY. IN NO EVENT SHALL SELLER'S LIABILITY UNDER ANY CLAIM MADE BY BUYER EXCEED THE PURCHASE PRICE PAID FOR THE PRODUCTS.**

**8. Confidential Information.** Buyer acknowledges and agrees that any technical, commercial, or other confidential information of Seller, including, without limitation, pricing, technical drawings or prints and/or part lists, which has been or will be disclosed, delivered or made available, whether directly or indirectly, to Buyer ("Confidential Information"), has been and will be received in confidence and will remain the property of Seller. Buyer further agrees that it will not use Seller's Confidential Information for any purpose other than for the benefit of Seller.

**9. Loss to Buyer's Property.** Any tools, patterns, materials, equipment or information furnished by Buyer or which are or become Buyer's property ("Buyer's Property"), will be considered obsolete and may be destroyed by Seller after two (2) consecutive years have elapsed without Buyer ordering the Products manufactured using Buyer's Property. Furthermore, Seller shall not be responsible for any loss or damage to Buyer's Property while it is in Seller's possession or control.

**10. Special Tooling.** "Special Tooling" includes but is not limited to tools, jigs, fixtures and associated manufacturing equipment acquired or necessary to manufacture Goods. Seller may impose a tooling charge for any Special Tooling. Such Special Tooling shall be and remain Seller's property notwithstanding payment of any charges by Buyer. In no event will Buyer acquire any interest in the Special Tooling, even if such Special Tooling has been specially converted or adapted for manufacture of Goods for Buyer and notwithstanding any charges paid by Buyer. Unless otherwise agreed, Seller has the right to alter, discard or otherwise dispose of any Special Tooling or other property owned by Seller in its sole discretion at any time.

**11. Security Interest.** To secure payment of all sums due from Buyer, Seller retains a security interest in all Products delivered to Buyer and, Buyer's acceptance of these Terms is deemed to be a Security Agreement under the Uniform Commercial Code. Buyer authorizes Seller as its attorney to execute and file on Buyer's behalf all documents Seller deems necessary to perfect Seller's security interest.

**12. User Responsibility.** Buyer, through its own analysis and testing, is solely responsible for making the final selection of the Products and assuring that all performance, endurance, maintenance, safety and warning requirements of the application of the Products are met. Buyer must analyze all aspects of the application and follow applicable industry standards, specifications, and any technical information provided with the Quote or the Products, such as Seller's instructions, guides and specifications. If Seller provides options of or for Products based upon data or specifications provided by Buyer, Buyer is responsible for determining that such data and specifications are suitable and sufficient for all applications and reasonably foreseeable uses of the Products. In the event Buyer is not the end-user of the Products, Buyer will ensure such end-user complies with this paragraph.

**13. Use of Products, Indemnity by Buyer.** Buyer shall comply with all instructions, guides and specifications provided by Seller with the Quote or the Products. **Unauthorized Uses.** If Buyer uses or resells the Products in any way prohibited by Seller's instructions, guides or specifications, or Buyer otherwise fails to comply with Seller's instructions, guides and specifications, Buyer acknowledges that any such use, resale, or non-compliance is at Buyer's sole risk. Further, Buyer shall indemnify, defend, and hold Seller harmless from any losses, claims, liabilities, damages, lawsuits, judgments and costs (including attorney fees and defense costs), whether for personal injury, property damage, intellectual property infringement or any other claim, arising out of or in connection with: (a) improper selection, design, specification, application, or any misuse of Products; (b) any act or omission, negligent or otherwise, of Buyer; (c) Seller's use of patterns, tools, equipment, plans, drawings, designs, specifications or other information or things furnished by Buyer;



## PARKER-HANNIFIN CORPORATION OFFER OF SALE

(d) damage to the Products from an external cause, repair or attempted repair by anyone other than Seller, failure to follow instructions, guides and specifications provided by Seller, use with goods not provided by Seller, or opening, modifying, deconstructing, tampering with or repackaging the Products; or (e) Buyer's failure to comply with these Terms. Seller shall not indemnify Buyer under any circumstance except as otherwise provided in these Terms.

**14. Cancellations and Changes.** Buyer may not cancel or modify, including but not limited to movement of delivery dates for the Products, any order for any reason except with Seller's written consent and upon terms that will indemnify, defend and hold Seller harmless against all direct, incidental and consequential loss or damage and any additional expense. Seller, at any time, may change features, specifications, designs and availability of Products.

**15. Limitation on Assignment.** Buyer may not assign its rights or obligations without the prior written consent of Seller.

**16. Force Majeure.** Seller is not liable for delay or failure to perform any of its obligations by reason of events or circumstances beyond its reasonable control. Such circumstances include without limitation: accidents, labor disputes or stoppages, government acts or orders, acts of nature, pandemics, epidemics, other widespread illness, or public health emergency, delays or failures in delivery from carriers or suppliers, shortages of materials, war (whether declared or not) or the serious threat of same, riots, rebellions, acts of terrorism, fire or any reason whether similar to the foregoing or otherwise. Seller will resume performance as soon as practicable after the event of force majeure has been removed. All delivery dates affected by force majeure shall be tolled for the duration of such force majeure and rescheduled for mutually agreed dates as soon as practicable after the force majeure condition ceases to exist. Force majeure shall not include financial distress, insolvency, bankruptcy, or other similar conditions affecting one of the parties, affiliates and/or sub-contractors.

**17. Waiver and Severability.** Failure to enforce any provision of these Terms will not invalidate that provision; nor will any such failure prejudice either party's right to enforce that provision in the future. Invalidation of any provision of these Terms shall not invalidate any other provision herein and, the remaining provisions will remain in full force and effect.

**18. Termination.** Seller may terminate any agreement governed by or arising from these Terms for any reason and at any time by giving Buyer thirty (30) days prior written notice. Seller may immediately terminate, in writing, if Buyer: (a) breaches any provision of these Terms, (b) becomes or is deemed insolvent, (c) appoints or has appointed a trustee, receiver or custodian for all or any part of Buyer's property, (d) files a petition for relief in bankruptcy on its own behalf, or one is filed against Buyer by a third party, (e) makes an assignment for the benefit of creditors; or (f) dissolves its business or liquidates all or a majority of its assets.

**19. Ownership of Software.** Seller retains ownership of all Software supplied to Buyer hereunder. In no event shall Buyer obtain any greater right in and to the Software than a right in the nature of a license limited to the use thereof and subject to compliance with any other terms provided with the Software.

**20. Indemnity for Infringement of Intellectual Property Rights.** Seller is not liable for infringement of any patents, trademarks, copyrights, trade dress, trade secrets or similar rights ("Intellectual Property Rights") except as provided in this Section. Seller will defend at its expense and will pay the cost of any settlement or damages awarded in an action brought against Buyer based on a third party claim that one or more of the Products sold hereunder infringes the Intellectual Property Rights of a third party in the country of delivery of the Products by Seller to Buyer. Seller's obligation to defend

and indemnify Buyer is contingent on Buyer notifying Seller within ten (10) days after Buyer becomes aware of any such claim, and Seller having sole control over the defense of the claim including all negotiations for settlement or compromise. If one or more Products sold hereunder is subject to such a claim, Seller may, at its sole expense and option, procure for Buyer the right to continue using the Products, replace or modify the Products so as to render them non-infringing, or offer to accept return of the Products and refund the purchase price less a reasonable allowance for depreciation. Seller has no obligation or liability for any claim of infringement: (i) arising from information provided by Buyer; or (ii) directed to any Products provided hereunder for which the designs are specified in whole or part by Buyer; or (iii) resulting from the modification, combination or use in a system of any Products provided hereunder. The foregoing provisions of this Section constitute Seller's sole and exclusive liability and Buyer's sole and exclusive remedy for claims of infringement of Intellectual Property Rights.

**21. Governing Law.** These Terms and the sale and delivery of all Products are deemed to have taken place in, and shall be governed and construed in accordance with, the laws of the State of Ohio, as applicable to contracts executed and wholly performed therein and without regard to conflicts of laws principles. Buyer irrevocably agrees and consents to the exclusive jurisdiction and venue of the courts of Cuyahoga County, Ohio with respect to any dispute, controversy or claim arising out of or relating to the sale and delivery of the Products.

**22. Entire Agreement.** These Terms, along with the terms set forth in the main body of any Quote, forms the entire agreement between the Buyer and Seller and constitutes the final, complete and exclusive expression of the terms of sale and purchase. In the event of a conflict between any term set forth in the main body of a Quote and these Terms, the terms set forth in the main body of the Quote shall prevail. All prior or contemporaneous written or oral agreements or negotiations with respect to the subject matter shall have no effect. These Terms may not be modified unless in writing and signed by an authorized representative of Seller.

**23. Compliance with Laws.** Buyer agrees to comply with all applicable laws, regulations, and industry and professional standards, including those of the United States of America, and the country or countries in which Buyer may operate, including without limitation the U.S. Foreign Corrupt Practices Act ("FCPA"), the U.S. Anti-Kickback Act ("Anti-Kickback Act"), U.S. and E.U. export control and sanctions laws ("Export Laws"), the U.S. Food Drug and Cosmetic Act ("FDCA"), and the rules and regulations promulgated by the U.S. Food and Drug Administration ("FDA"), each as currently amended. Buyer agrees to indemnify, defend, and hold harmless Seller from the consequences of any violation of such laws, regulations and standards by Buyer, its employees or agents. Buyer acknowledges that it is familiar with all applicable provisions of the FCPA, the Anti-Kickback Act, Export Laws, the FDCA and the FDA and certifies that Buyer will adhere to the requirements thereof and not take any action that would make Seller violate such requirements. Buyer represents and agrees that Buyer will not make any payment or give anything of value, directly or indirectly, to any governmental official, foreign political party or official thereof, candidate for foreign political office, or commercial entity or person, for any improper purpose, including the purpose of influencing such person to purchase Products or otherwise benefit the business of Seller. Buyer further represents and agrees that it will not receive, use, service, transfer or ship any Products from Seller in a manner or for a purpose that violates Export Laws or would cause Seller to be in violation of Export Laws. Buyer agrees to promptly and reliably provide Seller all requested information or documents, including end-user statements and other written assurances, concerning Buyer's ongoing compliance with Export Laws.



Parker Hannifin Corporation

**Sporlan Division**

206 Lange Drive • Washington, MO 63090 USA

phone 636 239 1111 • fax 636 239 9130

[www.zoomlockpush.com](http://www.zoomlockpush.com)