

# RIGHTEST

Blood Glucose Monitoring System

**BIONIME CORPORATION**

No. 100, Sec. 2, Daqing St., South Dist.,  
Taichung City 40242, Taiwan  
Tel: +886 4 2369 2388  
Fax: +886 4 2261 7586  
<http://www.bionime.com>  
E-mail: [info@bionime.com](mailto:info@bionime.com)

EC REP

**BIONIME GmbH**

Tramstrasse 16, 9442 Berneck  
Switzerland  
E-mail: [info@bionime.ch](mailto:info@bionime.ch)



Rev. Date: 2017-06

101-3GM782-011  
EN



**GM7005B  
USER'S MANUAL**



## Preface

Thank you for selecting the **Rightest™** Blood Glucose Monitoring System GM700SB. This manual provides all the information you need to operate this product for accurate test results. Please read this entire manual before you start any testing.

For people living with diabetes, it is important to regularly monitor blood glucose levels to effectively reduce complications from the disease. The easy-to-use **Rightest™** Blood Glucose Monitoring System GM700SB provides accurate, reliable test results to help you better manage your diabetes.

The **Rightest™** Blood Glucose Monitoring System GM700SB is designed for in vitro diagnostic use only (for self-testing by a single user outside the body). Testing requires only a small amount of fresh capillary whole blood from either the fingertip, palm or forearm.

Venous, arterial, and neonatal blood testing is limited to healthcare professional use only.

## Preface

The **Rightest™** Blood Glucose Monitoring System GM700SB is a personal blood glucose monitoring system to be used for self-testing only. It is not allowed for multiple users.

The testing result is calibrated to be plasma equivalent for test with fresh capillary, venous, arterial and neonatal whole blood samples. Capillary samples may be drawn from the fingertip, palm and forearm, and in the case of neonates, the heel. You may consult your healthcare professional for instructions on how to use the system correctly. Our customer support staff is available to assist you as well.

A healthcare professional should be contacted when Customer Service is not available.

Please forward your warranty card to customer support to activate your warranty coverage.

The **Rightest™** Blood Glucose Monitoring System GM700SB is manufactured and supported by Bionime Corporation. If you have any questions or concerns, please contact your local Bionime Customer Service or email to [rightest@bionime.com](mailto:rightest@bionime.com).

## Caution

- Before using the **Rightest™** Blood Glucose Monitoring System GM700SB to test your blood glucose, please read all of the instructions and conduct all of the tests including the quality control test (Refer to page 42).
- Please perform the quality control test regularly to make sure the test results are accurate.
- The **Rightest™** Meter GM700SB can only be used with **Rightest™** Test Strips GS700. Other brands' test strips should not be used under any circumstances. The use of other brands' strips may give inaccurate results.
- The **Rightest™** System GM700SB is intended for in vitro diagnostic use only. The test results using fresh capillary whole blood samples from the fingertip, palm and forearm are calibrated to be equivalent to plasma testing.
- Venous, neonatal or arterial blood testing should be performed by healthcare professionals.
- The **Rightest™** System GM700SB is intended for self-testing. It should not be used to diagnose diabetes mellitus.
- If the **Rightest™** Meter and Test Strips are exposed to a substantial change in temperature, please wait 30 minutes before measurement.
- Follow all environmental protection regulations when disposing of batteries.
- You may manually turn off the Bluetooth when you are in the radio-restricted area (like on the airplane).

## Caution

- Avoid contact with dripping or splashing liquids.
- The minimum blood sample size to test using the **Rightest™** Blood Glucose Monitoring System GM700SB is 0.75 $\mu$ L: ( • )

Sample Size Example

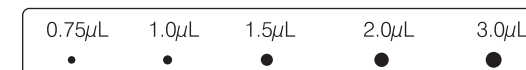

Blood sample size above 3.0 $\mu$ L might contaminate the test strip port and the meter. Blood sample size below 0.75 $\mu$ L may cause an inaccurate result or may prevent a meter reading. An Er4 reading will be displayed if the sample size is too small. In this case, repeat the test with a new test strip. The system has been tested with neonatal blood. As a matter of good clinical practice, be caution of the interpretation of neonate glucose value below 50 mg/dL (2.8 mmol/L). Please follow the recommendations for follow-up care that have been set by your intuition for critical glucose values in neonates. Once patient is suspected as rare disease (ex galactosemia), the glucose result should based on laboratory test.



### Important Safety Notes:

- All parts of the kit are considered biohazardous and can potentially transmit infectious diseases, even after following the cleaning and disinfecting procedures. Please refer to the section "Caring for Your Meter" on page 48.
- Users should wash their hands thoroughly with soap and water before and after handling the meter, lancing device, or test strips.

## Table of Contents

<b>About the <i>Rightest</i><sup>™</sup> Blood Glucose Monitoring System GM700SB</b>	
The <i>Rightest</i> <sup>™</sup> Blood Glucose Monitoring System GM700SB.....	8
The <i>Rightest</i> <sup>™</sup> Blood Glucose Meter GM700SB.....	10
The <i>Rightest</i> <sup>™</sup> Blood Glucose Test Strip GS700.....	14
<b>Before Testing</b>	
Meter Activation and Battery Change.....	16
Setting Up Your Meter - Setting the Date, Time and Volume.....	18
Turning On/Off the Meter.....	22
Handling the <i>Rightest</i> <sup>™</sup> Blood Glucose Test Strip GS700 .....	23
<b>Testing Procedure</b>	
Setting Markers.....	25
Getting Ready for Testing.....	26
Performing a Blood Glucose Test.....	27
Upload Data.....	32
Turn On / Off Bluetooth.....	33
Alternative Site Testing.....	34
View Window Appearance.....	36

## Table of Contents

Understanding Test Results and Messages.....	38
<b>Quality Control</b>	
About Quality Control Testing.....	39
Performing a Quality Control Test.....	42
Understanding Control Test Results.....	44
<b>Test Memory</b>	
Recalling Test Results.....	45
Recalling Average Test Results.....	46
Caring for Your Meter.....	48
Error Messages and Troubleshooting.....	49
Limitations.....	53
Specifications.....	54
Warranty.....	56
Customer Service.....	57
Expected Blood Glucose Values Without Diabetes.....	58
Component Manufacturer Information.....	59

## The **Rightest™** Blood Glucose Monitoring System GM700SB

### Contents

Your **Rightest™** Blood Glucose Monitoring System GM700SB consists of several items. Please identify each item, learn its name and how it is used.

Below are the items included in your **Rightest™** Blood Glucose Monitoring System GM700SB:

1. Getting Started Guide
  2. User's Manual (includes Log Book, Warranty Card, Emergency Card )
  3. **Rightest™** Blood Glucose Test Strip GS700 Package Insert \*
  4. **Rightest™** Control Solution GC700 Package Insert \*
  5. **Rightest™** Blood Glucose Meter GM700SB ( with 1 CR2032 battery installed )
  6. **Rightest™** Blood Glucose Test strips GS700 ( 10/25 pcs ) \*
  7. **Rightest™** Control Solution GC700 \*(Normal Level is provided in your starter kit)
  8. **Rightest™** Lancing Device \*
  9. Clear Cap \*
  10. Disposable Sterile Lancets ( 10 pcs ) \*
  11. Carrying Case ( not shown ) \*
  12. Instruction for the lancing device ( not shown ) \*
  13. Instruction for mobile App ( not shown )
- (\* Different packages have different bundled items. Some of packages might not include \* items.)

## The **Rightest™** Blood Glucose Monitoring System GM700SB



### NOTE

- GM700SB can concomitant use with mobile App, please refer to the "Instruction for mobile App" for detailed information.

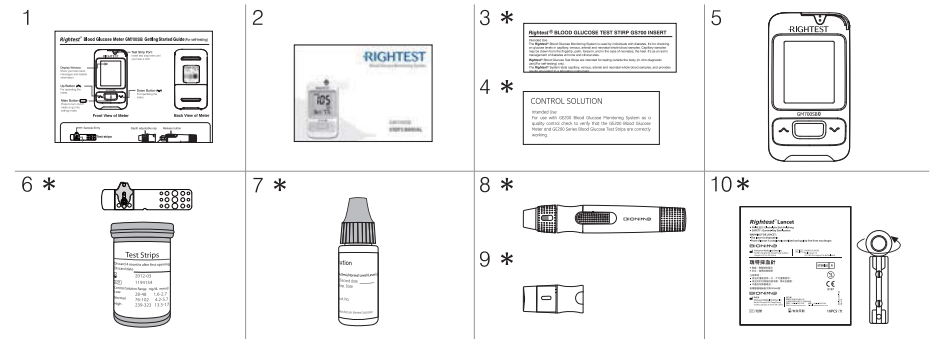

**The Rightest™ Blood Glucose Meter GM700SB**

**The Rightest™ Blood Glucose Meter GM700SB**

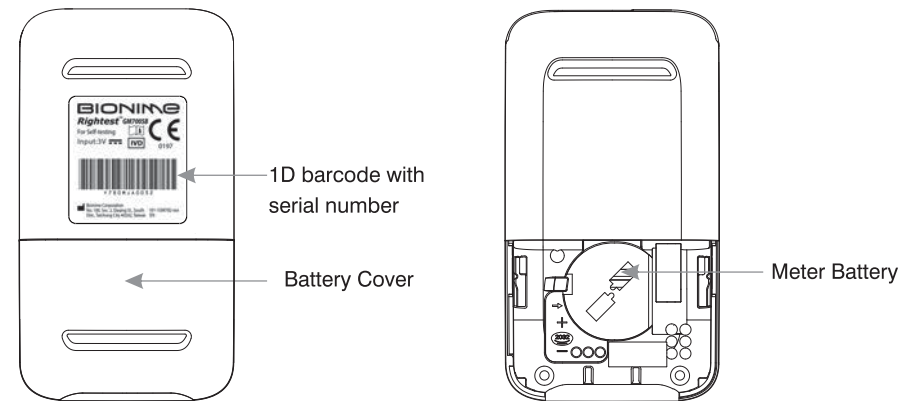
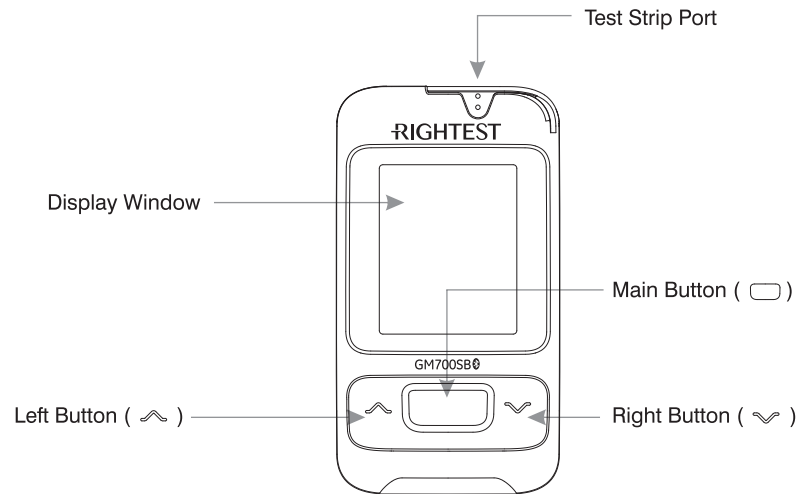

The Rightest™ Blood Glucose Meter GM700SB

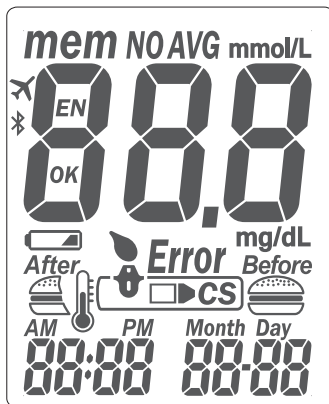

The Rightest™ Blood Glucose Meter GM700SB

<b>mem</b>	Indicates a test result stored in memory		Indicates when to apply the blood sample
<b>AVG</b>	Indicates the average result		Appears after you insert test strip into meter
<b>CS</b>	Indicates a control solution test result	<b>Error</b>	Appears when an error occurs
<b>mmol/L</b> <b>mg/dL</b>	Unit of test result	<b>Month Day</b> <b>00:00</b>	Current date under time mode or testing date under memory mode
<b>000</b>	Test result		Warns when the operational temperature limit is exceeded during testing
	Warns when the batteries are low or must be replaced	<b>AM</b> <b>PM</b>	Indicates the time in 12H format
<b>Before</b> <b>After</b>	indicates a meal marker with test result	<b>00:00</b>	Displays current time under time mode or testing time under memory mode
<b>OK EN ✕ NO</b>	Manufacturing use only		indicates that the Bluetooth is turned on



## The **Rightest™** Blood Glucose Test Strip GS700

The **Rightest™** Blood Glucose Meter GM700SB can only be used with **Rightest™** Blood Glucose Test Strips GS700 and **Rightest™** Control Solution GC700. The use of other test strips or control solutions can lead to incorrect results.

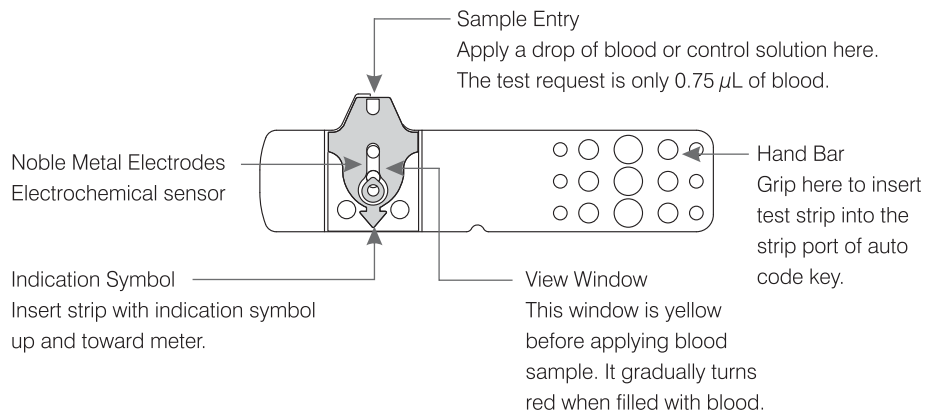

## The **Rightest™** Blood Glucose Test Strip GS700

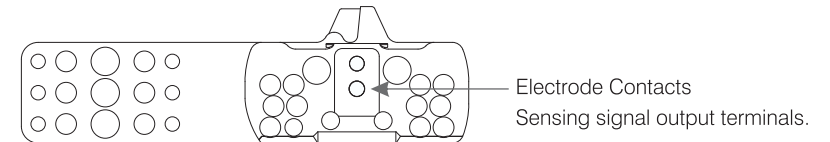

### **PRECAUTION**

- Close the **Rightest™** Blood Glucose Test Strip GS700 vial immediately after removing a test strip.
- Do not reuse **Rightest™** Blood Glucose Test Strip GS700.
- Do not use expired **Rightest™** Blood Glucose Test Strip GS700.
- When you open a new vial of **Rightest™** Blood Glucose Test Strip GS700, record the date on the vial. Discard the vial of test strips after 4 months from opening.
- Store the **Rightest™** Blood Glucose Test Strip GS700 in a cool ( 4-30°C or 39-86°F ) and dry location (< 90% relative humidity). Do not expose to direct sunlight or heat.
- If the **Rightest™** Blood Glucose Meter GM700SB and Test Strips are exposed to a substantial change in temperature, please wait 30 minutes before measurement.
- For detailed information, please refer to the **Rightest™** Blood Glucose Test Strip GS700 Package Insert.

## Meter Activation and Battery Change

Your **Rightest™** Blood Glucose Meter GM700SB comes with one CR2032, 3 volt, batteries installed. one new batteries will provide power to perform approximately 1000 tests under normal use. Press the main button or insert a strip to activate your meter.

## Meter Activation and Battery Change

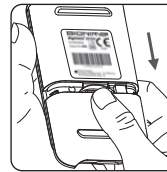

1. Turn the GM700SB Blood Glucose Meter over. Press and slide the battery cover to open.

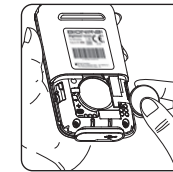

2. Install the batteries. Be sure to put the batteries in the correct direction (polarity (+) facing up).

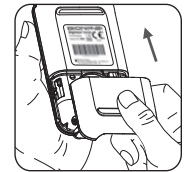

3. Slide the battery cover back until it snaps into place.

4. The **Rightest™** Blood Glucose Meter GM700SB will enter Self-Testing Mode automatically when replacing the battery (all symbols will appear on the screen).
5. Press any button under any picture to exit the self-test and enter Setting Mode.
6. You must set the time and date when replacing the battery. See Chapter "Setting Up Your Meter - Setting the Date, Time, and Volume" on page 18. Test results are still stored in the memory.



### CAUTION

- Please follow the local regulation to properly discard a used battery.

## Setting Up Your Meter - Setting the Date, Time and Volume

You can enter the Setting Mode two ways.

### 1. Replace the Battery

After removing the battery, press the main button several times until there is no signal on screen, then follow the battery installation steps to replace battery. The **Rightest™** Blood Glucose Meter GM700SB will perform a self-test. Press the main button to exit the self-test and enter the Setting Mode.

### 2. With Battery Inserted

When the meter is "ON", hold down the main button for 7 seconds. During this time the screen will go blank until you hear a beep. After the beep, the meter will turn on into the Setting Mode. The display screen will show setting data.

#### NOTE

- Use the Left and Right buttons to select your setting data and press the main button to confirm each selection. After confirming all of the settings, you will return to the Time Mode.

## Setting Up Your Meter - Setting the Date, Time and Volume

### 1. Year setting

With the year format blinking, press the Left or Right button until you see the current year. Press the Main button to confirm. Once the year is confirmed, the Month Setting will appear.



### 2. Month setting

With the month blinking, press the Left or Right button until you see the current month. Press the Main button to confirm. Once the month is confirmed, the Day Setting will appear.



### 3. Day setting

With the day blinking, press the Left or Right button until you see the current day. Press the Main button to confirm. Once the day is confirmed, the Time Setting will appear.



## Setting Up Your Meter - Setting the Date, Time and Volume

### 4. Time format 12/24H selection

With the time format blinking, press the Left or Right button to switch between 12H and 24H. Press the Main button to confirm. Once confirmed, the Hour Setting will appear.

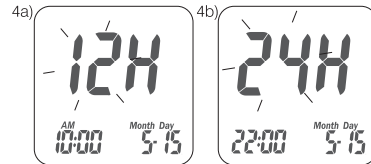

### 5. Hour setting

With the hour blinking, press the Left or Right button until you see the current hour. Press the Main button to confirm. Once the hour is confirmed, the Minute Setting will appear.



### 6. Minute setting

With the minutes blinking, press the Left or Right button until you see the current minute. Press the Main button to confirm. Once the minute is confirmed, the Volume Setting will appear.



#### NOTE

- The date and time will be corrected in every APP synchronization.

## Setting Up Your Meter - Setting the Date, Time and Volume

### 7. Volume Setting

With the volume blinking, press the Left or Right button to turn the volume on or off. Press the Main button to confirm and finish the settings.

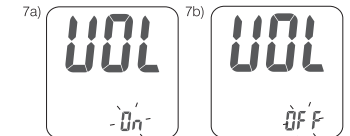

### 8. Setting the Unit of Measurement

With milligrams per deciliter (mg/dL) or millimoles per liter (mmol/L) blinking, press the Left or Right button to switch. Then press the Main button to confirm it and finish the settings.

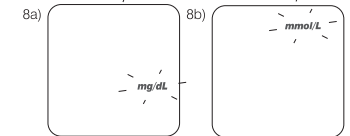

### 9. Ending setting

After measurement of unit setting, for confirmation you will hear a beep (if volume is turned on). All the settings are saved and completed and will return to time screen.

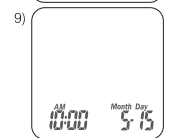

#### NOTE

- If you do no change any settings during Meter Set-up for over 2 minutes, the **Rightest™** Blood Glucose Meter GM700SB will leave setting mode - and power off automatically.  
 - Meter default is set according to your local preference.

## Turning On / Off the Meter

### 1. How to turn on the **Rightest™** Blood Glucose Meter GM700SB

Press the Main button or Insert a test strip.

### 2. Manual Power off

To power off the **Rightest™** Blood Glucose Meter GM700SB, press and hold the Main button for 3 seconds.

### 3. Auto Power off

The **Rightest™** Blood Glucose Meter GM700SB will power off automatically after 2 minutes if no buttons are pressed or no strip is inserted.

## Handling the **Rightest™** Blood Glucose Test Strip GS700

How to handle the **Rightest™** Blood Glucose Test Strip GS700.

### Inserting the **Rightest™** Blood Glucose Test Strip GS700:

1. Hold the **Rightest™** Blood Glucose Test Strip GS700 between your thumb and middle finger with the view window "  " facing up.

2. Put your forefinger on the side of the strip as shown.

3. Insert the **Rightest™** Blood Glucose Test Strip GS700 into test strip port until it clicks and firmly stops.

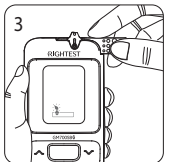
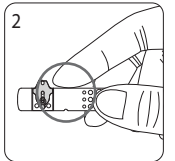
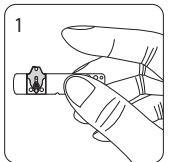

## Handling the *Rightest*<sup>™</sup> Blood Glucose Test Strip GS700

Removing the *Rightest*<sup>™</sup> Blood Glucose Test Strip GS700:

1. Hold the *Rightest*<sup>™</sup> Blood Glucose Test Strip GS700 as shown.

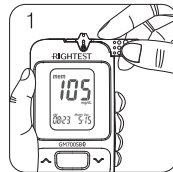

2. Rotate the *Rightest*<sup>™</sup> Blood Glucose Test Strip GS700 counterclockwise and pull up simultaneously.

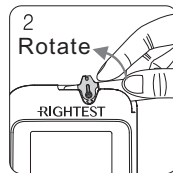

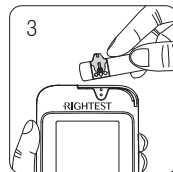

3. Take the *Rightest*<sup>™</sup> Blood Glucose Test Strip GS700 out of the test strip port.  
Please follow your local regulations and discard used strips properly.





## Setting Markers

According to actual life status, you can set meal markers with test result.  
You have to perform meal marker setting before testing.

1. Before test, press the Left or Right button to choose between the “” (before meal), “”, and “” (after meal) then press main button to confirm and do the test after setting.

2. If you don't set the marker in 15 seconds, the default marker will be “”.

	Before meal: You execute this blood glucose test before a meal.
	Regular test or definition by user.
	After meal: You execute this blood glucose test after a meal.



## Getting Ready for Testing

Before performing a blood glucose test, prepare the items below :

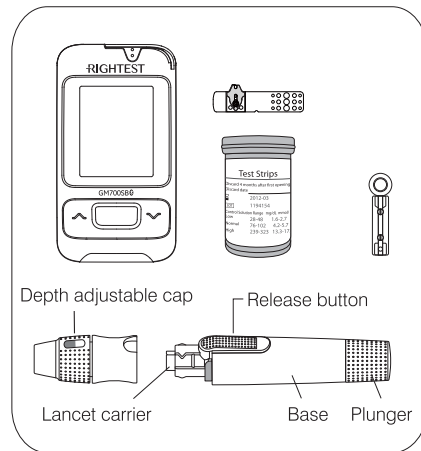
- **Rightest™** Blood Glucose Meter GM700SB
- **Rightest™** Blood Glucose Test Strips GS700  
(Please check the expiration date on the test strip vial. Do not use expired test strips)
- **Rightest™** Lancing device GD500
- Sterile lancet
- Alcohol swab (optional)



## Performing a Blood Glucose Test

1. Hold the depth adjustable cap in one hand and hold the base with the other hand. Bend the cap down. When a gap appears between the cap and base, pull the cap and base in opposite directions.
2. Pull off the depth adjustable cap.
3. Insert a new disposable lancet firmly into lancet carrier.
4. Twist off and set aside the protective cover of the disposable lancet.
5. Replace the depth adjustable cap.
6. Choose a depth of penetration by rotating the top portion of the depth adjustable cap until your desired setting is visible in the window. Settings are based on skin type  
 "  " for soft or thin skin; "  " for average skin;  
 "  " for thick or callous skin.

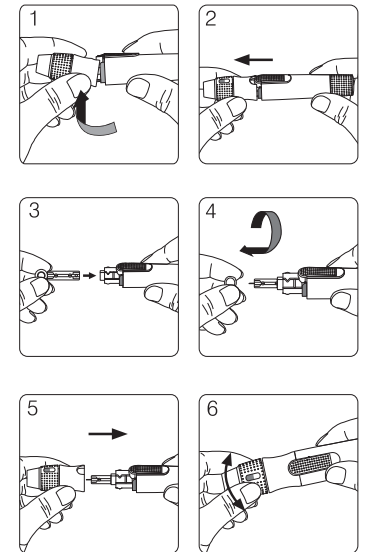

## Performing a Blood Glucose Test

7. Hold the base in one hand and pull on the plunger with the other hand. The device will be cocked. Release the plunger and it will automatically move back to its original position near the base.
8. Wash your hands with warm soapy water and dry thoroughly.
9. Take one **Rightest™** Blood Glucose Test Strip GS700 from the vial. Close the vial cap immediately.
10. Insert the strip into the test strip port of the **Rightest™** Blood Glucose Meter GM700SB with the view window facing up.
11. Once the strip is inserted, all symbols will appear on your meter display and will be accompanied by a beep (if volume is turned on).



### NOTE

- The **Rightest™** Blood Glucose Meter GM700SB will automatically detect the Code number on the test strip. You do not have to check the Code number on the meter display and strip vial.

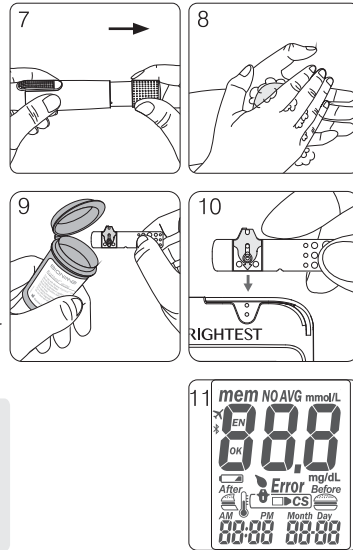

## Performing a Blood Glucose Test

12. After inserting a test strip, the "Before" icon will flash on the screen. Pressing the Right button to choose between the "Before" (before meal), "After" (after meal) and " " then press main button to confirm. Then a blood drop icon will appear on the display window and will be accompanied by a beep (if volume is turned on). Apply the blood sample within 2 minutes.
13. Place the lancing device against your fingertip and press the release button.
14. Touch and hold the blood drop to the edge of sample port until the view window is filled with blood. If the view window is not completely filled with blood the test will not start. If the blood sample was insufficient, discard the test strip and repeat with a new **Rightest™** Blood Glucose Test Strip GS700.

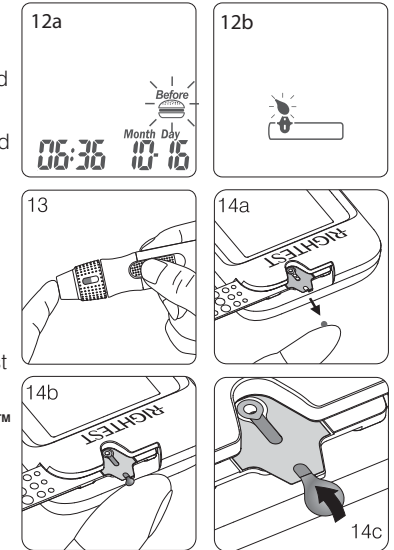



## Performing a Blood Glucose Test

15. Countdown Mode will begin on the display window. After 5 seconds, your test result will appear.
16. Pull off the depth adjustable cap. Without touching the used disposable lancet, insert the lancet tip into the protective lancet cover.
17. Hold the release button in one hand (see picture 18, step 1) and pull on the plunger with the other hand (see picture 18, step 2) to safely eject the used disposable lancet.
18. Discard the used disposable lancet into an appropriate puncture-proof or biohazard container.
19. Replace the depth adjustable cap after finishing the test.

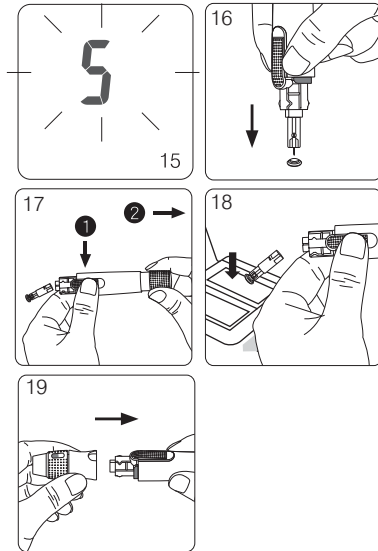

## Performing a Blood Glucose Test

### ⚠ CAUTION

- Do not apply your blood drop to the sample port on the strip until you see the " " appear. The **Rightest™** Blood Glucose Meter GM700SB is performing an internal test and will display " " and " **Error** " if you apply blood too soon. If this occurs, please repeat the test with a new test strip.
- Record the opening date of a new test strip vial. Discard the vial of test strips 4 months after opening.
- Always keep the metal contacts of the test strip port clean. If any dust or impurities are present, please clean with a small, soft brush.
- The **Rightest™** Blood Glucose Monitoring System GM700SB and **Rightest™** Lancing device GD500 are intended for a single user only. Do not share these devices with anyone, including other family members.
- All parts of this kit are considered biohazards and can potentially transmit infectious diseases, even after you have performed the cleaning and disinfecting procedure.
- Users should wash hands thoroughly with soap and water after handling the meter, lancing device, and test strips.

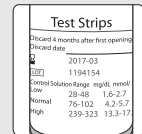

## Uploading Data

Bluetooth is always ON and when mobile App turn on, it will automatically pair with your mobile device.  
Once the connection successfully pairs, test results will start uploading to the connected mobile device.  
When the test result uploading has completed, Bluetooth will disconnect from mobile App automatically.

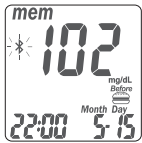

Bluetooth pairing.  
The symbol of Bluetooth "⌘" flashes.

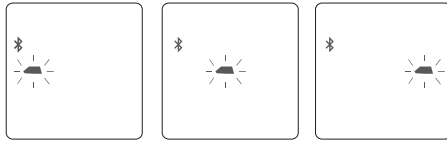

Data uploading.  
The GM700SB meter is now uploading test results to your mobile device.

## Turn On/ Off Bluetooth

### Turn off Bluetooth function

Press on the right or left button for 2 seconds to turn off the Bluetooth function.  
When the Bluetooth function is off, the "⌘" will not be shown on the screen.



### Turn on Bluetooth function

Press on the right or left button for 2 seconds to turn on the Bluetooth function.  
When the Bluetooth function is on, the "⌘" will flash on the screen.



#### NOTE

User should turn off meter or meter's Bluetooth function while traveling in flight. User can still perform blood glucose testing while the Bluetooth function is off.  
Please follow your airline flight safety instruction.

## Alternative Site Testing

### Alternative site testing: palm or forearm blood sampling

- To perform alternative site testing, install the clear cap for your **Rightest™** Lancing Device GD500. ( For detailed information, refer to the instruction manual for the **Rightest™** Lancing Device GD500. )
- To increase the blood flow, massage the intended puncture area of your palm or forearm for a few seconds.
- After massaging the intended puncture area, press and hold the lancing device with the clear cap against palm or forearm.
- Press the release button.
- Continue holding the lancing device against your palm or forearm and gradually increase pressure for a few seconds until the blood sample size is sufficient. (DO NOT test on the palm or forearm if you are testing for hypoglycemia (Low blood glucose).

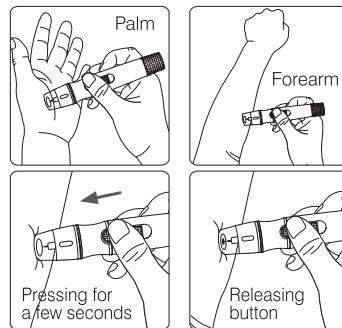

## Alternative Site Testing



### CAUTION

- Test results may vary if blood samples are taken from different sites or under certain conditions where glucose levels are changing rapidly such as: following a drink, a meal, an insulin dose or exercise. In these cases, only the fingertip should be used.
- DO NOT test on the palm or forearm if you are testing for hypoglycemia (Low blood glucose).
- Fingertip samples can show the rapid change in glucose faster than palm or forearm samples.
- Consult your healthcare professional before sampling from your palm or forearm.
- Since the blood flow in the forearm and palm is slower than in the fingertip, use the clear cap provided with the **Rightest™** Lancing Device GD500 when testing sites other than fingertip.
- If you use the normal lancing device for your palm or forearm, the blood sample may not be sufficient for meter operation.
- Periodically compare the test system to a laboratory test system that is known to be well maintained and monitored by a healthcare provider.

## View Window Appearance

Make sure your blood sample covers the whole area of the view window to get an accurate test result. An insufficient blood sample will result in an error message ("Er4"). If this occurs, repeat the test with a new test strip.

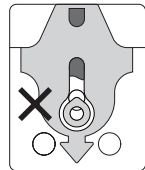

Insufficient blood sample

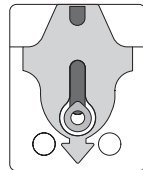

Sufficient blood sample

## View Window Appearance

### ⚠ CAUTION

- Check the expiration date printed on the strip vial every time you use a test strip. Do not use expired **Rightest™** Blood Glucose Test Strips GS700.
- Use each **Rightest™** Blood Glucose Test Strip GS700 immediately after removing it from the vial.
- Do not reuse **Rightest™** Blood Glucose Test Strips GS700.
- Do not perform testing immediately after moving from one ambient temperature to another (e.g. after coming indoors from the outside). Allow 30 minutes for the temperature of the meter and the test strips to equilibrate.
- Apply the blood sample only on the sample port of the test strip.
- Please don't drip or inject the blood sample directly by syringe to the sample entry of test strip. Doing this might contaminate the meter or cause damages and is not recommended.



## Understanding Test Results and Messages

The **Rightest™** Blood Glucose Meter GM700SB displays results between 10 and 600 mg/dL (0.6 and 33.3 mmol/L).

If the test result is below 10 mg/dL (0.6 mmol/L), “Lo” will appear on the screen. Please repeat your test with a new test strip.

If you still get a “Lo” result, contact your healthcare professional.

If the test result is above 600 mg/dL (33.3 mmol/L) “Hi” will appear on the screen. Please repeat your test again with a new test strip.

If you still get a “Hi” result, contact your healthcare professional.

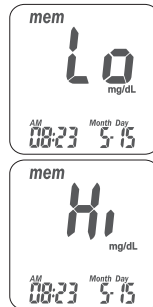

### NOTE

- If your blood glucose result is unusually high or low, or if you question your testing results, repeat the test with a new test strip. You can also run a Quality Control Test to check your meter and test strip. If the test result still remains unusually high or low, contact your healthcare professional immediately.
- If you are experiencing symptoms that are not consistent with your blood glucose test results and you have made sure to follow all instructions of this manual, contact your healthcare professional immediately.

## About Quality Control Testing

What is a Quality Control Test ?

To ensure proper monitoring function, it is necessary to regularly perform a quality control test.

Use one of the **Rightest™** Control Solutions GC700 when testing your **Rightest™** Blood Glucose Monitoring System GM700SB in the Control Solution Mode. If the test result is within the Control Solution Range printed on the strip vial label, the **Rightest™** Blood Glucose Monitoring System GM700SB passes the Quality Control Test and your **Rightest™** Blood Glucose Monitoring System GM700SB is working properly.

### Control Solution Range:

Example of Control Solution Range printed on your test strip vial label.

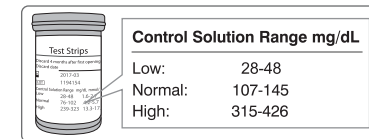

### NOTE

- Normal of **Rightest™** Control Solution GC700 is provided in your starter kit. If you want to purchase, High or another Normal control solutions, please contact customer service.

## About Quality Control Testing

### When should a Quality Control Test Be Performed ?

- To ensure that your **Rightest™** Blood Glucose Meter GM700SB and **Rightest™** Blood Glucose Test Strip GS700 are working properly.
- To confirm that you are following the correct testing procedures.
- To prepare for your initial blood glucose test.
- To check the **Rightest™** Blood Glucose Test Strip GS700 when you open a new vial of strips.
- To check your **Rightest™** Blood Glucose Meter GM700SB after it has been dropped, damaged or exposed to liquids.
- If you suspect that your test results are inaccurate, or if your test results are not consistent with the way you feel.
- To practice testing.

### Required Items for Quality Control Tests

To perform a quality control test, prepare the items below :

- **Rightest™** Blood Glucose Meter GM700SB
- **Rightest™** Blood Glucose Test Strips GS700
- **Rightest™** Control Solution GC700

## About Quality Control Testing



### CAUTION

- Each time you open a new bottle of control solution, write the expiration date on the label. The **Rightest™** Control Solution GC700 is good for 3 months after opening the bottle, or until the expiration date printed on the label, whichever comes first.

### Example

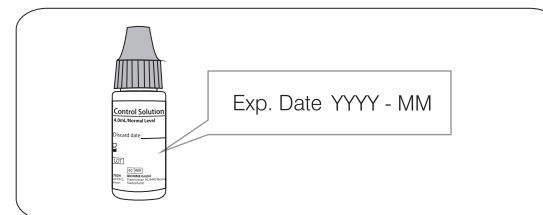

- Wipe the bottle cap with a clean tissue before tightly closing the bottle of control solution.
- Close the bottle of control solution tightly immediately after using.
- Check the expiration date before use. (Refer to the **Rightest™** Control Solution GC700 Package Insert).
- Keep control solution bottles out of reach of children.

## Performing a Quality Control Test

1. Take one **Rightest™** Blood Glucose Test Strip GS700 from the vial and close the vial cap immediately.
2. Insert the strip into the test strip port of the **Rightest™** Blood Glucose Meter GM700SB with the view window facing up.
3. While the before meal icon is flashing on the display window, press and hold the Right or Left button for at least 3 seconds until the "CS" symbol appears.
4. You will see the blinking "☹" icon and "CS" icon on the screen, prompting you to apply the corresponding level of **Rightest™** Control Solution GC700.
5. Shake the bottle of **Rightest™** Control Solution GC700 well before opening the cap. Place the cap on a flat surface.
6. Place a drop of control solution onto the top of the cap.
7. Gently touch the sample port of the strip with the control solution from the top of the cap.
8. The screen will display the count time starting from 5 (you will hear a beep if the volume is turned on).

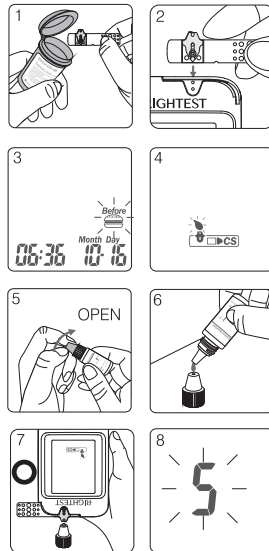

## Performing a Quality Control Test

9. Tightly replace the cap on the **Rightest™** Control Solution GC700 bottle.
10. The control solution result will appear. Compare your Quality Control Test result to the Control Solution Range printed on the **Rightest™** Blood Glucose Test Strip GS700 vial label.

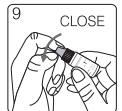

### ⚠ CAUTION

- Your Control Solution Test results will not be included in the average calculations, however, they can still be recalled and viewed. The Control Solution Test result will be shown with the "CS" icon on the screen.
- The Control Solution Test should be conducted between 6-44°C (43-111°F).
- Before "☹" and "CS" appear, do not touch the control solution to the sample port on the strip. The **Rightest™** Blood Glucose Meter GM700SB is performing an internal check. Touching the control solution to the sample port before prompted will result in an error message: "Error" and "☹" and be accompanied by beeps (if volume is turned on).
- Do not drip the control solution on to the sample port of the test strip directly. The reagent on the strip might leak into the bottle of control solution and may cause the degeneration of the control solution. This could contaminate the meter via the test strip port.
- Keep the test strip port clean and dry. Clean immediately if the test strip port is stained or is overly exposed to moisture.
- Do not touch the tip of the control solution bottle. If the tip is touched, clean with water.
- If you have request for Quality Control Test, please connect Customer Service.



## Understanding Control Test Results

Your control solution test results should fall within the control solution range printed on the test strip vial label. If the results are within the range, the **Rightest™** Blood Glucose Monitoring System GM700SB is working correctly.

Example of control solution range printed on your test strip vial label		
Low	Normal	High
40~60 mg/dL	88~120 mg/dL	250~340 mg/dL

Possible reasons your Control Solution results are out of the range :

- Your **Rightest™** Control solution GC700 is expired or was first opened more than 3 months ago.
- Your **Rightest™** Blood Glucose Test Strip GS700 has expired.
- You left the cap of the Blood Glucose Test Strip vial or the control solution off for a period of time.
- You did not perform the test procedure correctly.
- The **Rightest™** GM700SB Blood Glucose Meter or **Rightest™** Blood Glucose Test Strip GS700 have malfunctioned.

If **Rightest™** Control Solution GC700 results are out of range, your **Rightest™** Blood Glucose Monitoring System GM700SB may not be working properly. Repeat the Quality Control Test. If your control solution results are still out of range, do not use **Rightest™** Blood Glucose Meter GM700SB to test your blood glucose. Please contact customer service.

## Recalling Test Results

The **Rightest™** Blood Glucose Meter GM700SB is able to automatically store a maximum of 500 test results with time and date. If your meter has stored 500 results, the newest test result will replace the oldest one.

To recall your test memory, start the meter without a test strip inserted.

1. Press the Main button to switch from the Time Mode to Memory Mode. You will see the "mem" icon in the upper left corner of the display. The testing date-time, index number and year will be appeared with result.
2. Use either the Left or Right button on the side to review all previous results with date and time. Results display from the most recent (Sequence no. "1") to the oldest (Sequence no. "500") in the lower right hand corner of the screen.
3. The Quality Control Test result can be recalled from the saved data. When "cs" appears next to the data, the test was performed by the **Rightest™** Control Solution GC700. The control solution test result will not be used when recalling test average results.





## Recalling Average Test Results

The **Rightest™** Blood Glucose Meter GM700SB provides several average test results. View the 1-day, 7-days, 14-days, 30-days, 60-days and 90-days average test results for better blood glucose monitoring.

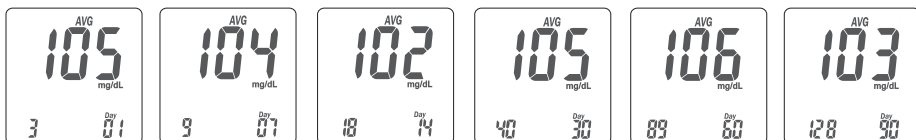

1. Press the Main button to switch the screen to Average Mode.
2. On the average screen, use either the Left or Right button to view 1-day, 7-days, 14-days, 30-days, 60-days or 90-days averages.
3. The number shown in the lower right hand corner indicates how many test results have been calculated.

## Recalling Average Test Results

### 5. Quick Searching:

To view test results in sequential order automatically, enter the Memory Mode. Press the Right or Left button for 2 seconds. (The Right button is for viewing from the most current to the oldest test results. The Left button is for viewing from the oldest to the most current test results). Release the button to stop at any particular test result.



### NOTE

- The Average function requires that the correct time and date is set. Test results must exist during the desired time interval. For example: To get a 14-day average on 1/30/11, you must have test results dated between 1/17 and 1/30. If no test results exist during that time frame you will not receive an average.
- The "Lo", "Hi" results, control solution test results and test results under abnormal temperature < 6°C (43°F), > 44°C (111°F) will be excluded from average calculations.

## Caring for Your Meter

### Maintenance

Keep your meter and test strip free of dust, water or any other liquid. Store the meter in the carrying case when not in use. If your meter is dropped or damaged, perform a quality control test with the control solution before performing a blood glucose test.

### Cleaning Meter

Clean the outside of the meter with a damp cloth and mild soap/detergent. Do not get the test strip port wet.

### Cleaning Test Strip Port

If your test strip port is stained with blood, control solution or any liquid, please use a dry tissue or alcohol swab to clean it immediately. Do not use anything wet to clean it. Perform a quality control test to ensure the **Rightest™** Blood Glucose Meter GM700SB is working properly.

## Error Messages and Troubleshooting

### Temperature Error

1. In order to get accurate testing results, please test between 6-44 °C (43-111 °F).
2. When the temperature is below 6 °C(43°F) or over 44 °C (111°F), the meter will not function and the "**Error**" symbol will blink.
3. If the **Rightest™** Blood Glucose Meter GM700SB and Test Strips are exposed to a substantial change in temperature, please wait 30 minutes before measurement.

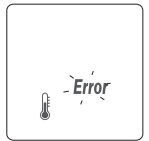



## Error Messages and Troubleshooting

### Battery Error

1. The "  " and " **Error** " symbols appear and the meter will not function when the battery is low. Change the batteries immediately.

### Strip Error

1. When the test strip is inserted incorrectly, the meter will beep 4 times while the "  " symbol flashes. Do not apply a sample on the test strip. Please re-insert the unused test strip correctly (refer to "Handling the **Rightest™** Blood Glucose Test Strip GS700" on Page 23 for more information).
2. If, after performing the required steps, the "  " and flashing " **Error** " symbols appear on the screen, it means the **Rightest™** Blood Glucose Test Strip GS700 has been inserted incorrectly more than twice. Please, re-insert the unused test strip again after reviewing the steps on how to insert a test strip correctly on p.23 or call Customer Service for support. This error message can also indicate that you may have used the wrong test strips. Please check the test strip vial to ensure you are using the **Rightest™** Blood Glucose Test Strip GS700.

### Sampling Error

Please do not apply the blood to the sample port of the test strip before the meter displays "  ". Discard the test strip if the meter shows " **Error** ".

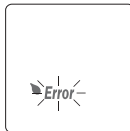
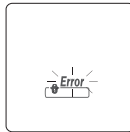
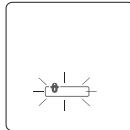
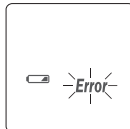

## Error Messages and Troubleshooting

- Er1** - The inserted test strip has been used or damaged. Please use a new test strip.
- Er2** - The meter has malfunctioned. Do a Quality Control Test or reinstall the batteries to check if the meter works properly.
- Er3** - The signal transmission is disrupted. Repeat the test using a new test strip.
- Er4** - The blood sample volume is insufficient. Repeat the test using a new test strip.
- Er5** - An issue calibrating the Meter has occurred. Please follow the steps below:
- (1) Remove the test strip from the meter.
  - (2) Turn off the meter (press and hold the Main button for 3 seconds).
  - (3) Press the main button to turn ON the meter.
- If after turning on the Meter, you do not see Er5, your meter is functioning properly and able to perform a test.

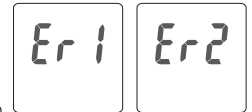

If one of the above error messages still appears, please contact Bionime Customer Service.

### Meter Malfunction

If the **Rightest™** Blood Glucose Meter GM700SB will not turn on, please follow the steps below:

1. Open the battery cover and remove the batteries.
2. Wait for 5 minutes and reinsert the batteries as described as instructed on page 16, (Meter Activation and Changing the Battery).

The meter should work normally after finishing the above steps. If the meter still does not work, please contact your local Bionime customer service.

## Error Messages and Troubleshooting

### CAUTION

A blood sample should ONLY be applied to the test strip after the test strip has been inserted correctly and the Meter's screen is showing the image of the test strip and a blood drop flashing symbol. If the blood drop flashing symbol is NOT showing on the screen, do not apply a sample to the test strip. Please re-insert the unused test strip correctly. The screen MUST show the image of the test strip accompanied by the blood drop symbol flashing (this symbol takes 3 seconds to show after correctly inserting the test strip) in order for a sample to be applied. Please consult your User Manual and/or contact Customer Service for support on how to correctly insert a **Rightest™** Blood Glucose Test Strip GS700.

## Limitations

- **Rightest™** Blood Glucose Monitoring System GM700SB is not intended for serum or plasma testing.
- Inaccurate test results may be obtained at altitudes greater than 10,000 feet (3048 meters) above sea level.
- Severe dehydration and excessive water loss may cause inaccurately low results.
- The glucose test may be invalid in the presence of abnormally high concentration:  
Ascorbic acid  $\geq 5$  mg/dL (0.28 mmol/L), Xylose  $\geq 20$  mg/dL (1.33 mmol/L) and Uric Acid  $\geq 20$  mg/dL (1.19 mmol/L).
- Not for screening or diagnosis of diabetes mellitus.
- Not for use on critically ill patients in shock, dehydrated patients or hypo-osmolar patients.
- Alternative site testing (AST) should only be performed during steady-state times (when glucose is not changing rapidly).
- Alternative site testing should not be used to calibrate continuous glucose monitoring systems (CGMS).
- Alternative site testing should not be performed if testing for hypoglycemia (Low blood glucose).
- Results from alternative site testing should not be used in insulin dose calculation.
- Regarding potential electromagnetic or other interference, keep meter out of electromagnetic radiation sources.

## Specification

Measurement Technology	Dehydrogenase Electrochemical Sensor
Sample	Capillary, Venous, Arterial and Neonatal whole blood
Minimum Sample Volume	0.75 $\mu$ L (microliters)
Measuring Range	10 - 600 mg/dL (0.6~33.3 mmol/L)
Test Time	5 seconds
Memory Capacity	500 blood glucose test results with date and time
Power Saving	Turns off automatically 2 minutes after last user action. To turn off manually, press the button "  " for 3 seconds.
Operating Temperature	6 - 44 °C (43 - 111 °F)
Operating Relative Humidity	10 - 90 %

## Specification

Hematocrit	20 ~ 70 % when blood glucose $\leq$ 200 mg/dL (11.1 mmol/L), 20 ~ 60 % when blood glucose > 200 mg/dL (11.1 mmol/L)
Power Supply	One CR2032 Battery (3 Voltage)
Battery Life	Approximately 1000 standard tests
Meter Dimension	82 mm x 45 mm x 15.5 mm
Meter Weight	43 $\pm$ 5g with batteries
Monitor	LCD
Display Area	34 mm x 27.5 mm
Meter Storage/ Transportation Conditions	-10 - 60 °C ( 14 - 140 °F )
Test Strip Storage/ Transportation Conditions	4 - 30 °C ( 39 - 86 °F ) , < 90% relative humidity

## Warranty

Bionime Corporation warrants that this product will be free from defects in materials and workmanship for five years from the date of purchase.

This warranty does not apply to the performance of a **Rightest™** Blood Glucose Meter GM700SB that has been altered, misused, tampered with or abused in any way.

This warranty applies only to the original purchaser of the **Rightest™** Blood Glucose Monitoring System GM700SB.

Please complete and return the enclosed warranty card.

Different models have different specifications. This warranty applies only to the **Rightest™** Blood Glucose Monitoring System GM700SB; other models are not covered with this warranty card.













### NOTE

- During blood glucose measurement, the **Rightest™** Blood Glucose Meter GM700SB itself may come into contact with blood. All parts of the **Rightest™** Blood Glucose Monitoring System GM700SB are considered biohazardous and can potentially transmit infectious diseases. Please follow your local regulations to properly dispose of the used **Rightest™** Blood Glucose Monitoring System GM700SB after removing the batteries.

## Customer Service

We sincerely like to provide complete, considerate services to our customers. Please review all the instructions to make sure you are performing the steps correctly. If you have any questions or in case of problems with the products, please contact your local Bionime customer service or email to [rightest@bionime.com](mailto:rightest@bionime.com).

### Description of used symbols

 IVD	For in vitro diagnostic use	 Manufacturer	 Biological risks
 LOT	Lot number	 Expiry date	 WEEE
 Temperature limitation		 For single use only	 EC Representative
 CE 0197	CE-mark (with No. of notified body)	 Consult the instruction for use	
 STERILE R	Method of sterilization using irradiation		
 Caution	Caution (consult instructions for use and warnings)		

## Expected Blood Glucose Values Without Diabetes

### Expected glucose values without diabetes <sup>(1)</sup>

Fasting Blood Glucose	
GLUCOSE LEVEL	INDICATION
From 70 to 99 mg/dL (3.9 to 5.5 mmol/L)	Normal fasting glucose
From 100 to 125 mg/dL (5.6 to 6.9 mmol/L)	Pre-diabetes (Impaired fasting glucose)
126 mg/dL (7.0 mmol/L) and above on more than one testing occasion	Diabetes

### References

1) Diabetes Information - American Association for Clinical Chemistry (AACC)[Electronic Version]  
Retrieved Dec. 21, 2015 from  
[www.labtestsonline.org/understanding/analytes/glucose/test.html](http://www.labtestsonline.org/understanding/analytes/glucose/test.html)

## Component Manufacturer Information

### Blood Glucose Meter, Test Strip, Control Solution

Manufacturer: Bionime Corporation  
No. 100, Sec. 2, Daqing St., South Dist., Taichung City 40242, Taiwan  
Product complies with In Vitro Diagnostic Medical Device Directive 98/79/EC (CE 0197).  
EC-Rep: Bionime GmbH, Tramstrasse 16, 9442 Berneck, Switzerland

### Lancing Device

Manufacturer: Bionime Corporation  
No. 100, Sec. 2, Daqing St., South Dist., Taichung City 40242, Taiwan  
Product complies with Medical Device Directive 93/42/EEC  
EC-Rep: Bionime GmbH, Tramstrasse 16, 9442 Berneck, Switzerland

### Disposable Sterile Lancets

Manufacturer: SteriLance Medical (SuZhou) Inc.  
No.68 LiTangHe RD, XiangCheng, SuZhou, JiangSu 215133, P.R. China  
Product complies with Medical Device Directive 93/42/EEC (CE 0197).  
EC- Rep: EMERGO EUROPE, Molenstraat 15, 2513 BH The Hague, The Netherlands