



# C P01

3 CCT & 4 Wattage Adjustable Canopy Light

75W, 100W, 120W



150lm/w



IP65



IK08



Selectable



Macrowave  
motion sensor



Plug-and  
play PIR



## Design

CP01 is a pretty cost-effective gas station light with a simple but stylish design. The aluminum die-casting heat sink comes with light weight but excellent thermal management performance.

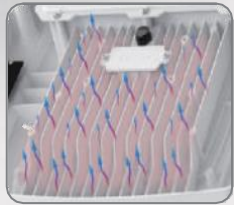

Lightweight



Reflective cup



Glasstyle

## Visual comfort & People Oriented

When choosing to add the reflector, light is soft and even. You will feel great visual comfort.

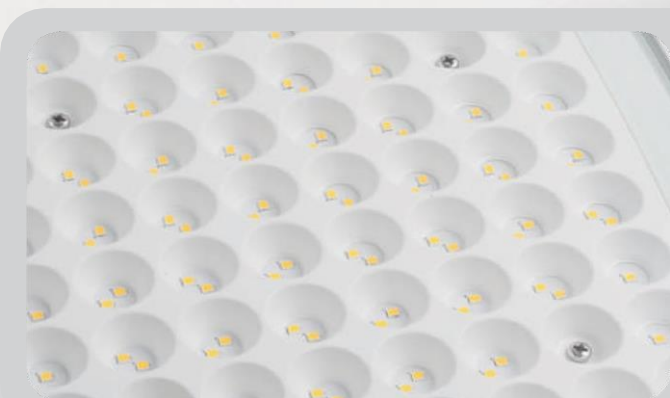

# 3 CCT & 4 wattage adjustable

For glass version, when with a built-in dip switch, 3 CCT&4 wattage adjustable is available, which can dramatically help save SKU and shipping cost.

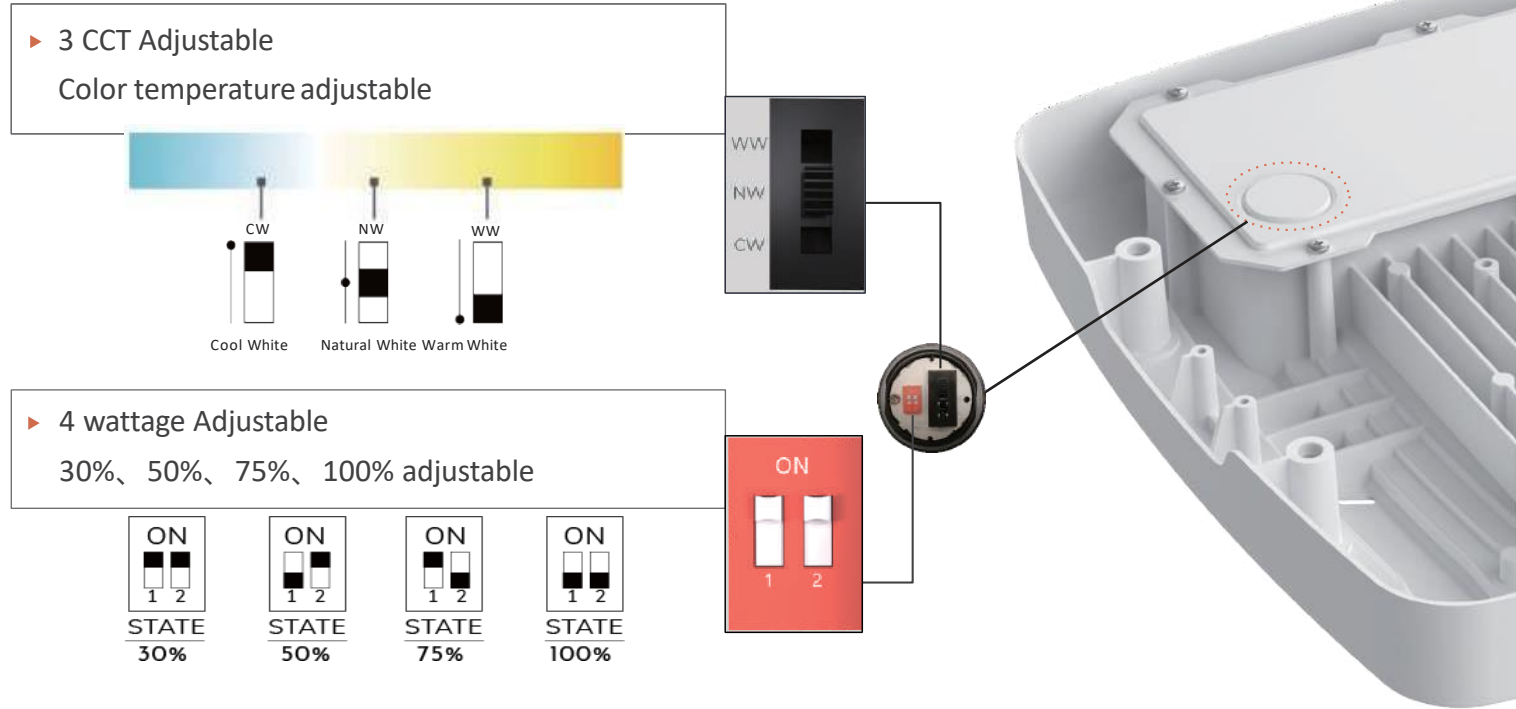

## Microwave & PIR Sensor

Plug-and-play Microwave and PIR sensor control make it more energy-saving based on 150lm/w and saves your electric bills.

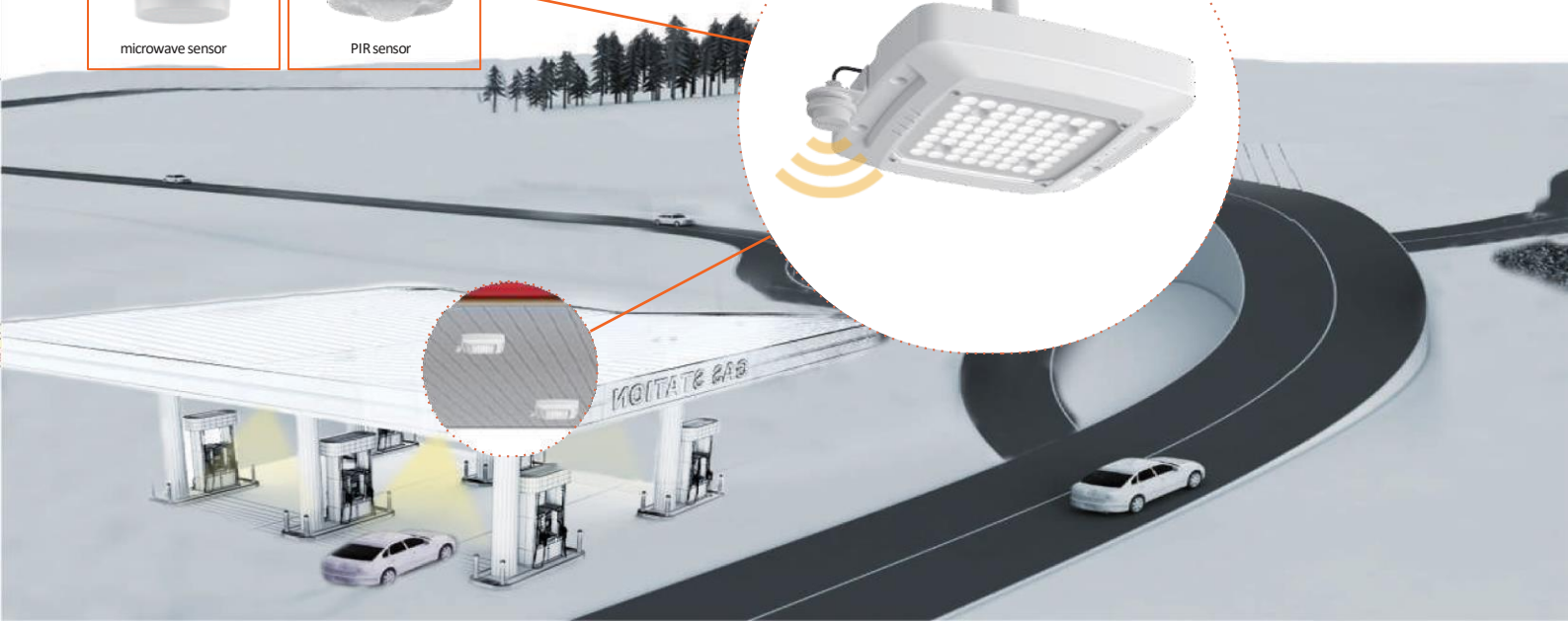

# CP01 Product Range



Model No	EGE-CP01-75	EGE-CP01-100	EGE-CP01-120
Power Consumption (±5%)	75W	100W	120W
Input Voltage	120-240VAC/ 50 / 60Hz		
Control	0-10V DALI (optional) Plug-and-play Microwave or PIR sensor (optional)		
Luminous Flux (±10%)	11250lm	15000lm	18000lm
Emcac(4000K Ra70)	150lm/W		
CCT & CRI	4000K( 3000K/5000Koptional) Ra70 ( Ra80optional)		
Beam Angle	90°(U00C05)/120°(U00A01)		
Protection Rating	IP65, IK08		
Operating Temperature	-30°Cto + 50°C		

## Photometric Diagrams

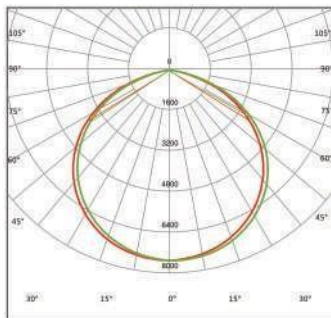

U00A01

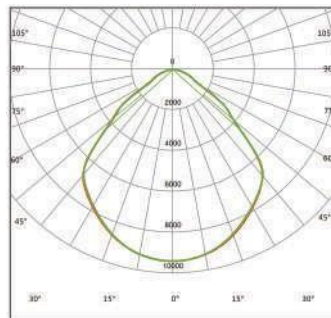

U00C05



# Specifications - CP01 LED Canopy Light



Electrical Information			
Model No.	EGE-CP01-075	EGE-CP01-100	EGE-CP01-120
Power Consumption(±5%)	75W	100W	120W
Power Supply	DONE		
Input Voltage	120-240VAC / 50 / 60 Hz		
Power Factor	>0.9		
Surge Protection	6kV line-line, 10kV line-earth		
Driver Type	Constant Current (CC)		
Control	0-10V		
	DALI		
	Plug-and-play Microwave or PIR sensor		

Optic Information			
LED Type	LED 2835		
Luminous Flux (±10%)	11250lm	15000m	18000lm
Efficacy(4000K Ra70)	150lm/w		
Correlated Color Temperature	4000K ( 3000K/5000K optional)		
Color Rendering Index	Ra70 ( Ra80 optional)		
Beam Angle	90*(U00C05)/120*(U00A01)		
UGR level	/		

Dimensions and Mount	
Product Dimension	369.5x368.5x65mm(14.55"x14.51"x2.56")
Luminaire Net Weight	3.9±0.3kg(8.60±0.66Lbs)
Export Carton Size	390x390x90mm(15.35"x15.35"x3.54")
Gross Weight	4.63±0.3kg(8.81±0.66Lbs)
Mounting Option	Surface mount
	Surface mount with adapter plate
	G 3/4 conduit mount
Material	ADC12 Tempered Glass
Finish	Powder Coating
Fixture Color	White(RAL 9016)
EPA	NA
IK Rating	IK08
IP Rating	IP65

Lifespan and Warranty	
Operating Temperature	-30°C to + 50°C(-22°F to+122°F)
Life Time of LED @Ta=25°C	45000hrs-L90
	93000hrs-L80
	148000hrs-L70

## Description

CP01 is a pretty cost-effective gas station light with a simple but stylish design. It is designed with a high level of product recognition. The aluminum die-casting heat sink comes with light weight but excellent thermal performance. Multiple functions like 0-10V, DALI, plug-and-play Microwave or PIR sensor control make it more energy-saving based on 150lm/w. When adding the inside reflector, you will feel great visual comfort. With a built-in dip switch, 3 CCT&4 wattage adjustable is available, which can dramatically help save SKU.

## Key Features

- Full wattage 75W, 100W, 120W.
- High light efficacy 150lm/W.
- 3 CCT&4 wattage adjustable available
- Multiple installations: surface mount, G 3/4 conduit mount and mount with adapter plate.
- IP65&IK08.

## Applications

- Gas station
- Underground parking lot
- Warehouse
- Industrial facility
- Exhibition center
- Shopping mall
- Toll station

## New Features

The power could be set to 30%, 50%, 75% and 100%.  
The CCT could be set to Cool White, Natural White and Warm White.  
Please select a suitable Power and CCT by the switch.

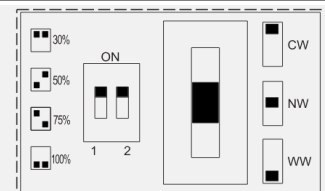

\* Please consult us for details.

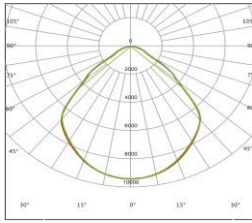

U00C05 (For single CCT version only)

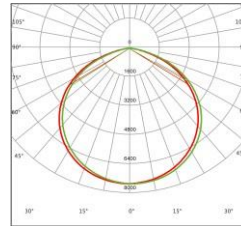

U00A01 (For 3 CCT adjustable version only)

Mounting Options

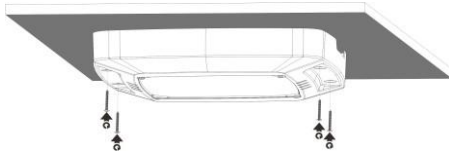

Surface mount

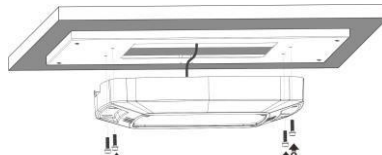

Surface mount with adapter plate

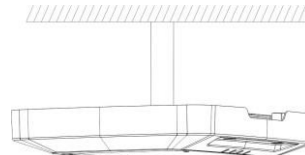

G 3/4 conduit mount

Dimensions

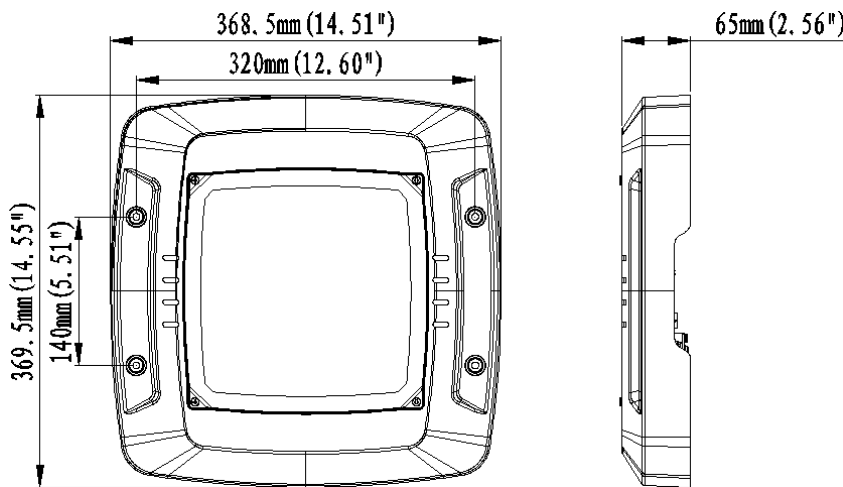

Accessories



**G 3/4 adapter plate**  
SPCC materials with outdoor powder coating  
Code:BC-C01-01

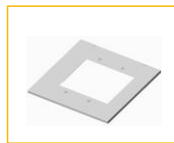

**Ceiling mount adaptor**  
SPCC materials with outdoor powder coating  
Code:BC-C01-02



**PIR sensor**  
Code:ANT-6-4T



**Microwave motion sensor**  
Code:ANT-5-4T