

# GREASE TRAP GTA350

Approved By  
Local Authority

*"No More Clogged and  
Stinking Problem".*

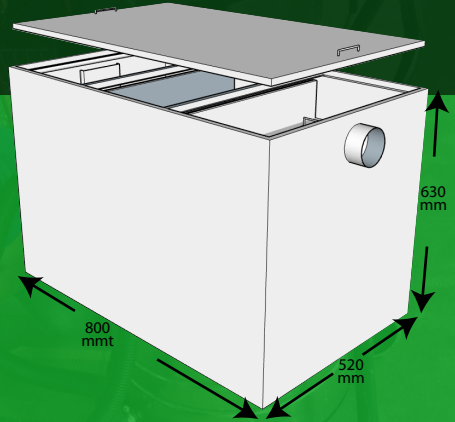

## MODEL SPECIFICATIONS

**Model Name:** GTA350  
**Flow Rate (Minutes):** 50 GPM  
**Meals Served Daily:** 400-600  
**Pipe Size (mm):** 3"  
**Grease Trap's Size:**  
32" (L) x 22" (W) x 25" (H) inches  
**Maximum Grease & Waste Water  
Trap Capacity:** 176 litre  
**Maximum Capacity until Overflow:** 262 litre  
**Material:** 304 Stainless Steel  
**Suitability:** Mamak Restaurant/  
Workshop

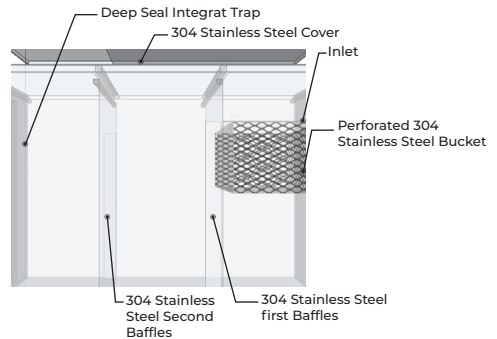

\* In keeping with our policy of updating products we reserve the right to make improvements or changes.



Product Brand:  
**ULTRAEJAU**®