

GREASE TRAP GTA3400

Approved By
Local Authority

*"No More Clogged and
Stinking Problem".*

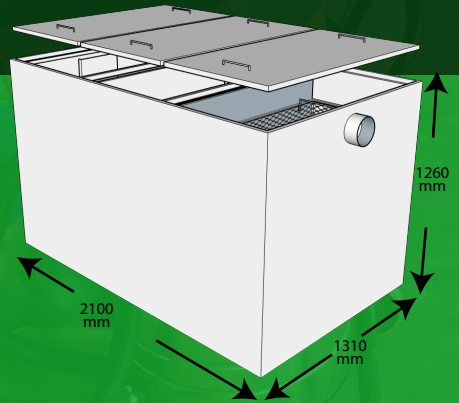

MODEL SPECIFICATIONS

Model Name: GTA3400
Flow Rates (Minutes): 400 GPM
Meals Served Daily: 7800-9400
Pipe Size (mm): 6"
Grease Trap's Size:
83" (L) x 52" (W) x 50" (H) inches
**Maximum Grease & Waste Water
Trap Capacity:** 2613 litre
**Maximum Capacity until
Overflow:** 3466 litre
Material: 304 Stainless Steel
Suitability: Factory/Canteen/
Hotel

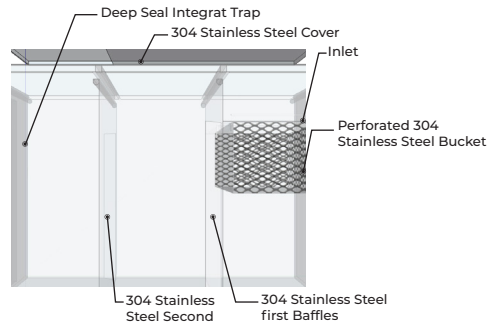

* In keeping with our policy of updating products we reserve the right to make improvements or changes.



Product Brand: **ULTRAEJAU**®