



Thermo Scientific™ Orion Star™ T900 Series Potentiometric Titrators

User Manual

68X700190 | Revision 2.0 | December 2019

Contents

Chapter 1	6
Titrator Overview.....	6
Introduction.....	6
Titrator Overview.....	6
Terminology.....	7
Safety Precautions.....	9
Chapter 2	11
Unpacking and Initial Setup.....	11
Unpacking the Titrator	11
Titrator Initial Setup.....	12
Attaching the Electrode Holder	12
Installing the Burette	13
Installing the Tubing.....	14
Installing Electrodes, Accessories and Devices.....	14
Connecting the Electrodes and Probes.....	14
Connecting the Power Supply.....	14
Connecting External Devices	15
Updating Titrator Software.....	15
Chapter 3	16
Titrator Preparation	16
Instrument Setup Wizard	16
Titrator Home Screen	16
Titrant Preparation.....	18
Changing the Titrant	18
Titration Setup Wizard	19
Step 1: Setup Electrode.....	19
Step 2: Setup Titrant.....	20
Step 3: Setup Titration	22
Example Parameter Settings from App Notes	25
General Settings.....	32

Diagnostics.....	32
Display.....	32
Temperature Input	32
Files and Info	32
Notifications.....	32
Logs	33
Exporting Data Logs	33
Orion Star T900 Series Computer Software	34
Methods	37
Using Preprogrammed Methods	38
Burette.....	38
Direct Measure.....	39
Chapter 4	41
Titrator Use and Maintenance	41
Titration Mode.....	41
Standardization Mode	44
Calibrate Mode.....	46
MKA Mode.....	48
Maintenance Schedule	50
General pH Electrode Maintenance.....	51
Dispense Verification Procedure	51
Titrator and Burette Storage	53
Chapter 5	54
Customer Services.....	54
Troubleshooting	54
Troubleshooting Checklist.....	54
Frequently Asked Questions	54
Warranty Information.....	57
Technical Support Assistance	58
Regulatory Statements	59
Titrator Specifications	60
Ordering Information.....	62
Chapter 6	66

Appendix	66
Calculating a Reaction Ratio	66
Selecting the Result Units	66
Titration Result Units	66
MKA Result Units	67
Titrator Calculations	67
Direct Titration Calculations	67
Blank Correction in Direct Titration	67
Back Titration Calculations	68
Reaction Ratios in Back Titration	68
Amount of Reagent in Back Titration	68
Concentration Calculation in Back Titration	69
Multiple Endpoints	70
Titrant Standardization	70
Multiple Known Addition (MKA)	71
User Defined Results	72

Chapter 1

Titration Overview

Introduction

Titration Overview

Thermo Scientific™ Orion Star™ T900 series laboratory titrators are designed to increase lab productivity by automating potentiometric titrations. These compact titrators are simple to use with easy navigation from setup to live titration analysis to data transfer, all on a large color graphic touchscreen display. Create and save up to ten custom user-defined methods or use preprogrammed protocols, all with onscreen instructions and help menus, so everyone in the lab can be up to speed quickly and easily.

We have integrated our core electrochemistry technology with a state-of-the-art reagent dispensing system to create a modern, simplified automated titrator designed to make performing titrations easier, more reliable, more reproducible and faster than manual titrations. Our automated titrators expand the number of ions and compounds that can be measured beyond direct electrode analysis and offer dynamic process controls that adjust the titration to optimize analysis results.

The Orion Star T900 series titrators include four models:

- Orion Star T910 pH titrator
- Orion Star T920 redox titrator
- Orion Star T930 ion titrator
- Orion Star T940 all-in-one titrator

These titrators have the ability to calibrate the electrode (sensor), standardize titrants and perform various types of potentiometric titrations. The Orion Star T930 ion titrator and Orion Star T940 all-in-one titrator offer the added benefit of multiple known addition (MKA) analysis, where the titrator performs an automated calibration and calculation of sample concentration by adding aliquots of standard to sample.

Ideally suited for dedicated, routine measurements, the Orion Star T900 series titrators are designed to help laboratories overcome problems of sample throughput or analytical

complexity through automation of analysis. What differentiates the Orion Star T900 series titrators from other single parameter instruments and automatic titrators are their simplicity. All setup procedures appear on the display in the form of easy-to-understand, sequential menus. Because the analysis is automated, each titration step is carried out consistently time after time, operator to operator, using a high precision burette that meets ISO 8655 standard. Whether the analysis is acidity of juices, alkalinity of water, surfactants in shampoo, fluoride in drinking water or Vitamin C in juices, the Orion Star T900 series titrators offer a simple system to automate measurements. Please visit www.thermofisher.com/titrator for additional information on Thermo Scientific Orion instruments, electrodes and solutions.

Use the Orion Star T910 pH titrator for dedicated acid-base titrations including titratable acidity of juices and wines, acidity of food products, alkalinity of waters, acidity and alkalinity of consumer products, total acid number (TAN) and total base number (TBN). Titration techniques include equivalence point titrations and preset pH endpoint titrations.

Use the Orion Star T920 redox titrator for dedicated redox titrations including sulfite/SO₂ and reducing sugar in juice and wine, ascorbic acid (vitamin C) and peroxide value in food products, dissolved oxygen in wastewater by Winkler titration and organic matter in soil. Titration techniques include equivalence point titrations and preset mV endpoint titrations.

Use the Orion Star T930 ion titrator for dedicated ion concentration titrations including salt in food products, chloride in drinking water and wastewater, ammonia and Total Kjeldahl Nitrogen (TKN) of wastewater, surfactants in consumer products and total hardness of drinking water and wastewater. Titration techniques include equivalence point titrations and preset mV endpoint titrations plus multiple known addition (MKA) mode. Using MKA mode, the titrator performs an automated calibration and calculation of sample concentration by adding aliquots of standard to sample, removing the need for a separate calibration and minimizing matrix effects.

Use the Orion Star T940 all-in-one titrator for flexible pH, redox and ion concentration titrations including equivalence point titrations, preset pH or mV endpoint titrations plus multiple known addition (MKA) mode for automated known addition of various ions.

Terminology

The terminologies used in this manual are explained here:

Titration

The device used to perform the titration, titrant standardization or direct measurement.

Titrant

Reagent of known concentration that is added to a sample and results in an observable reaction and endpoint or equivalence point.

Sample

Solution of unknown concentration that is titrated using a titrant to determine the concentration.

Burette

Component that dispenses a measured volume of titrant into the sample by pulling the titrant from the reagent bottle into the burette and then pushing the titrant from the burette to the dispensing probe and into the sample.

Electrode

Also called probe or sensor, the device in the solution performing the measurement.

Mode

Measurement type being used by the titrator (pH, mV, ISE).

Method

A set of saved parameters and values for a particular titration including the electrode, titrant and titration setup parameters as well as electrode calibration and titrant standardization when applicable.

pH

pH measurements compare the relative acidity or alkalinity of a solution at a given temperature. A pH of 7 describes a neutral solution because the activities of hydrogen and hydroxide ions are equal. When the pH is below 7, the solution is described as acidic because the activity of hydrogen ion is greater than that of hydroxide ion. A solution is more acidic as the hydrogen ion activity increases and the pH value decreases. Conversely, when the pH is above 7, the solution is described as basic (or alkaline) because the activity of hydroxide ion is greater than that of hydrogen ion.

Redox / ORP

ORP (Oxidation / Reduction Potential) measures the oxidizing

or reducing nature of a sample. This gives an overall indication of how "reactive" the sample is. ORP measurements are common in water, wastewater, process water and plating bath applications.

ISE (Ion Selective Electrode)

Ion selective electrodes measure the concentration of specific ions in sample solutions such as water, wastewater, consumer goods, foods and beverages. Ion selective electrodes are available for ammonia, ammonium, bromide, cadmium, calcium, carbon dioxide, chloride, chlorine, cupric, cyanide, fluoride, fluoroborate, iodide, lead, nitrate, potassium, silver, sodium, sulfide, surfactant and thiocyanate.

All-in-One

Titrator that combines the functionality of the pH, redox and ion titrators into one unit.

Titration

Technique that is based upon the addition of a reagent (titrant) that reacts with the sample species. The changes in electrode potential are observed and sample concentration is calculated from the volume of reagent that is chemically equivalent to the sample species.

Equivalence/Inflection Point Titration

Technique of adding small aliquots of a titrant to the sample, recording the potential changes and applying a first derivative analysis to the data, from which the equivalence point (inflection point of the curve) is calculated. The technique assumes that the change in mV reading per volume of titrant added will be greatest at the equivalence point. This technique is a very precise technique for performing routine titrations with a sharp, clear inflection point.

Preset Endpoint Titration

Type of titration where aliquots of the titrant are added until a predetermined mV or pH value is reached. This is a fast way to do a titration, but requires that the sample and its reaction with the titrant be well known. The preset endpoint technique is useful for analyses without a clearly defined inflection point and is often a technique required by industry standards.

Multiple Known Addition (MKA)

Known addition is a technique of adding small aliquots of the species of interest to the sample and calculating the original sample concentration from the observed changes in potential. The electrode chosen for analysis should sense the

species of interest. This technique helps minimize matrix effects and offers greater precision than direct calibration measurement.

In multiple known addition, three or more additions are made to the sample allowing electrode slope, E_0 , sample concentration and a spike recovery to be calculated. This is a very precise technique because the calibration is performed directly in the sample matrix during analysis.

Unique benefits of multiple known addition include the level of precision of the analysis may be chosen and each sample analysis is automatically verified by a spike recovery analysis.

Direct Titration

Technique in which the titrant reacts directly with the chemicals in the sample solution and titrant consumption is directly related to the quantity of the chemicals in the sample.

Back Titration

Technique in which excess quantity of a reagent is added to the sample, so that the entire sample reacts with the reagent and some un-reacted reagent remains. The un-reacted excess reagent is titrated with suitable titrant. If the amount of reagent added to the sample is known, the sample concentration can be calculated.

Blank and Blank Titration

A blank is used when performing a back titration or when a background correction is necessary (background level of the measured species is present prior to analysis). The blank value can be manually entered or automatically calculated by performing a blank titration. Whether a blank value is manually entered or determined by blank titration, make sure that all samples analyzed by that method are prepared in the same manner. If the sample preparation changes, a new blank must be manually entered or determined by blank titration. Most routine titration methods do not require a blank.

ROSS pH Electrodes

Not all pH electrodes are created equal – It is critical that the measurements customers perform day-to-day are accurate and reproducible. Customers rely on their pH electrodes to measure their samples quickly and precisely, making pH electrodes an essential part of the lab. ROSS pH electrodes offer superior measurement stability, fast response, high accuracy and precision even in samples with varying temperatures, no long-term drift and long lifespan.

Orion Ion Selective Electrodes (ISEs)

Measurement by an ion selective electrode (ISE) can be performed in virtually every laboratory. Efficient and economical - electrode measurements can be simpler and faster than other analytical techniques. Time consuming sample steps such as filtration and distillations are rarely needed and analysis time is typically 1-2 minutes per sample. Compared to other analysis methods, there is a relatively small setup cost. Ion selective electrodes can be used for determination of a titration endpoint and are useful as endpoint detectors because they are unaffected by sample color or turbidity.

Orion Electrochemistry Solutions

Customers need to be able to rely on their measurements and using high-quality solutions to calibrate and maintain electrodes is the best way to ensure data is both accurate and reproducible. Using low-quality, home-made, or expired buffers can lead to measurement errors, which require lengthy troubleshooting, or even worse – can go unnoticed. Using high-quality solutions eliminates one of the major causes of measurement inaccuracy.

Orion solutions are manufactured for accuracy and repeatability to the highest quality standard in the industry. Orion solutions are produced in controlled batches using ultra pure water and undergo rigorous quality testing throughout the process to prevent contamination before and after bottling. Buffers and standards have lot-specific certificates of analysis with NIST-traceable testing results.

Safety Precautions

Thermo Fisher Scientific does not accept any liability for damage that may arise if information in this manual is not followed. Therefore, the operating instructions and specifications must be read and understood by all persons involved in installation and operation of this equipment.

Thermo Fisher Scientific will not be liable for direct, indirect, special, incidental or consequential damages resulting from any defect or omission in this manual. Thermo Fisher Scientific reserves the right to make changes in this manual and the products it describes at any time, without notice or obligation. Revised editions are found on the Thermo Fisher Scientific website. Intended operators should read and understand the entire manual before operating this system. Special attention should be given to all safety and caution notes contained in this manual and the Low Voltage Directive (LVD) document. Failure to do so could result in serious injury to the operator or damage to the equipment.

Definition of Signal Warnings and Symbols

Safety notes are marked with signal words and warning symbols. These show safety issues and warnings. Ignoring the safety notes may lead to personal injury, damage to the instrument, malfunctions and false results. Make sure that the protection provided by this equipment is not impaired. Do not use or install this equipment in any manner other than that specified in this manual.



CAUTION: Indicates a hazardous situation with low risk resulting in damage to the device or the property or in loss of data or minor or medium injuries if not avoided.



WARNING: Indicates a hazardous situation with medium risk possibly resulting in severe injuries or death if not avoided.

ATTENTION: Indicates important function of the product.

Note: Indicates useful information about the product.



WARNING: Indicates situations where dangerous voltages exist and potential for electrical shock is present.



This symbol indicates that a risk of explosion is present.

Orion Star T900 Series titrators utilize instrument technology that complies with all industry recognized safety rules. Certain hazards may arise in extraneous circumstances. NEVER open the housing of the instrument. It is not meant to be maintained or repaired by the user. Opening the instrument may jeopardize the safety and accuracy of the instrument. If you ever have problems with the instrument, contact your authorized Thermo Fisher dealer or service representative.

Intended Use

This instrument is designed to perform potentiometric titrations in laboratory environment by knowledgeable laboratory technicians trained to operate titrations. It is suitable for the processing of reagents and solvents. The use requires knowledge and experience in working with toxic and corrosive substances which pose inherent danger. Use of this instrument requires knowledge and experience working with application specific reagents, which may be toxic or hazardous.

Location Safety

The instrument must be operated indoors only and must not be used in explosive environment. Place the instrument in a well-ventilated location where it can rest in leveled position, protected from direct sunlight or sources of excessive heat, corrosive atmosphere and mechanical upset (danger of being knocked down, exposed to strong vibrations etc.).

Operate at temperatures between 5°C and 40°C. Avoid environment with frequent temperature changes as they influence bubble formation and potentially affect the accuracy.



CAUTION: Always wear protective clothing in the laboratory when working with the instrument. A lab coat and eye protection such as goggles should be worn. Use appropriate (and undamaged) gloves when handling chemicals or hazardous substances.





WARNING: Risk of electric shock:

Power to the instrument is supplied with a 3-pin grounded power cable. Always maintain the grounding of the instrument for safety reasons. Never use ungrounded electrical outlet or extension cables without grounding conductors. NEVER defeat the grounding intentionally.



WARNING: Risk of corrosion: Tubing, connections and loose titration vessels are a safety risk. They all can leak corrosive liquids. To prevent this:

1. Make sure all connections are tightened well by hand, avoiding excessive force to prevent damage.
2. When making tubing connections, be careful to avoid cross threading of the fitting.
3. Inspect all tubing for signs of rupture or other damage.
4. Inspect all vessels for signs of damage or leaks.
5. Before using corrosive or toxic reagents, run the test with water to make sure all leak free and safe.



WARNING: Flammable solvents:

All relevant safety measures must be observed when working with flammable solvents and chemicals. Always consult SDS (Safety Data Sheet) for the liquids that will be used.

1. Your workplace must not be in proximity of any sources of flame or excessive heat.
2. Always consult and comply with SDS (Safety Data Sheet) and recommendations from the manufacturer for any solvents and chemicals.
3. Always observe general lab safety rules.



WARNING: Chemicals: All relevant safety measures are to be observed when working with chemicals.

1. Set up the instrument in a well-ventilated location.
2. Any spills should be wiped off immediately.
3. Always consult and comply

with SDS and recommendations from the manufacturer for any solvents and chemicals.



WEEE Compliance: This product is required to comply with the European Union's Waste Electrical & Electronic Equipment (WEEE) Directive 2012/19/EU. It is marked with the symbol shown here. Thermo Fisher Scientific has contracted with one or more recycling / disposal companies in each EU Member State and this product should be disposed of or recycled through them. Further information on compliance with these directives, the recyclers in your country, and information on Thermo Scientific Orion products that may assist the detection of substances subject to the RoHS Directive are available by contacting us using the contact information in this user manual

Chapter 2

Unpacking and Initial Setup

Unpacking the Titrator

Unpack the Orion Star T900 series titrator from its shipping carton and inspect it for damage. Verify that all the parts listed here are included. If damage is evident or if the shipment is incomplete, please contact your local distributor or Technical Service at wlp.techsupport@thermofisher.com. It is recommended that you keep the titrator box, and do not dispose of it during unpacking, so it can be used for repacking and long-term storage.

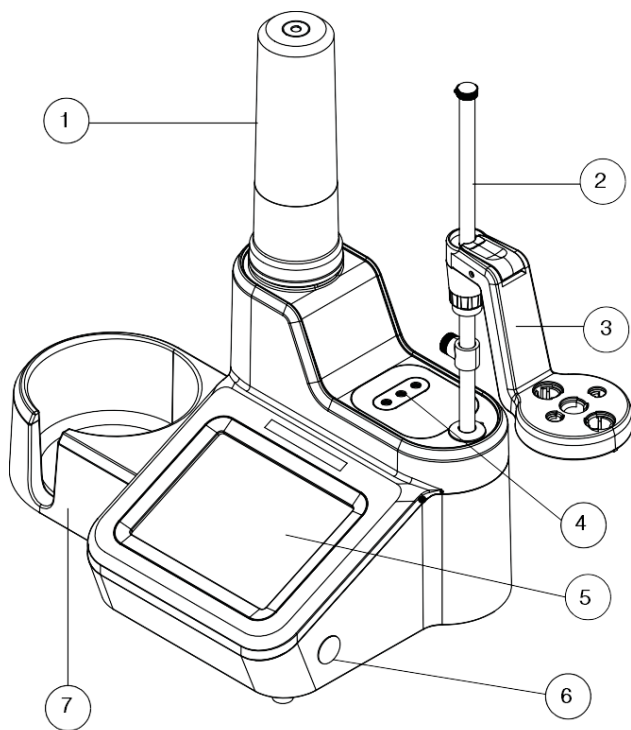

Figure 1. Titrator Components

1 Burette Cover	5 Touch Screen
2 Electrode Holder Shaft	6 On/Off Button
3 Electrode Holder Head	7 Reagent Bottle Holder
4 Tubing Connections	

The Orion Star T900 series titrator packaging contains the following items:

- Titrator
- 20 mL Burette
- Burette Cover
- Electrode Holder
- Stirrer Probe
- Dispenser Probe
- Standard Tubing Kit
- Drying Tube for Desiccant
- Reagent Bottle Holder
- 1 L Plastic Reagent Bottle
- GL38 Reagent Bottle Cap
- USB Computer Cable
- USB Flash Drive with User Manual
- 110-240 V Power Adapters

The included power supply consists of a universal power adapter and country specific AC power cords for US, EU, UK, AU and China:



Titration Initial Setup

Attaching the Electrode Holder

1. Attach the Electrode Holder Shaft by inserting the shaft into the hole on the top of the titrator and aligning the slots on the shaft with the tracks on the holder. Refer to **Figure 2**.

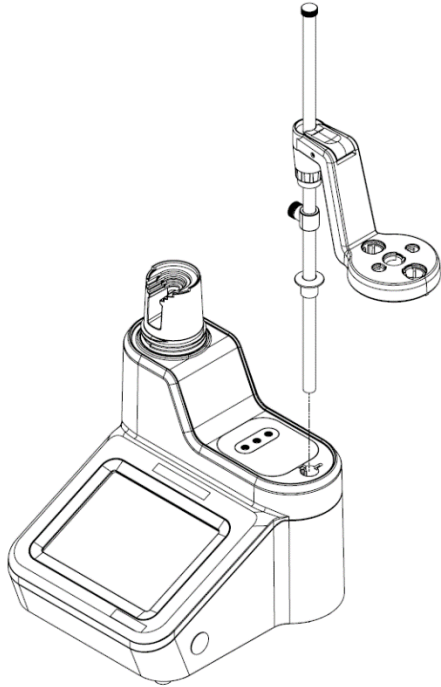

Figure 2. Electrode Holder Shaft Attachment

2. Access the bottom of the titrator and secure the shaft using the captive screw on the bottom of the titrator and the screwdriver included with the titrator. Refer to **Figure 3**.

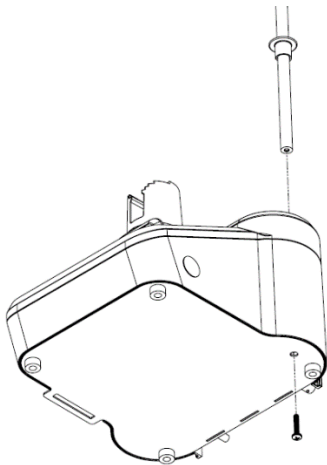

Figure 3. Screw Location for Securing Holder

3. Adjust the Electrode Holder Head location on the Electrode Holder Shaft by pressing the release button (3a) and sliding it to the appropriate location on the shaft. Refer to **Figure 4**.

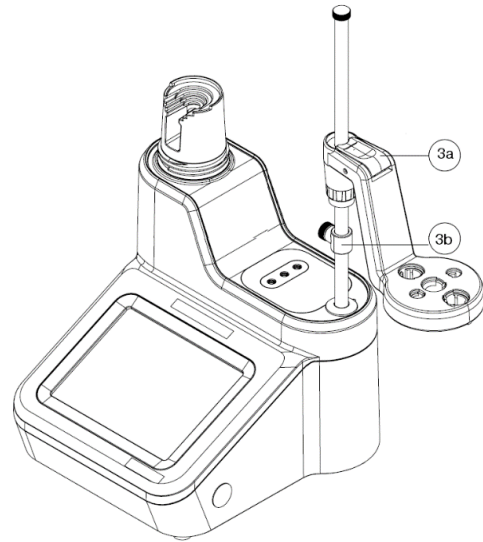

Figure 4. Positioning the Electrode Holder

4. Insert the electrodes and probes into the labeled slots on the electrode holder head:



5. As appropriate, adjust the location of the stopper (3b) on the electrode holder shaft to limit how far down the electrode holder head can be moved. This may be helpful to prevent electrode breakage.
6. As appropriate, use the cable management accessory to organize electrode cables and wires:



Installing the Burette

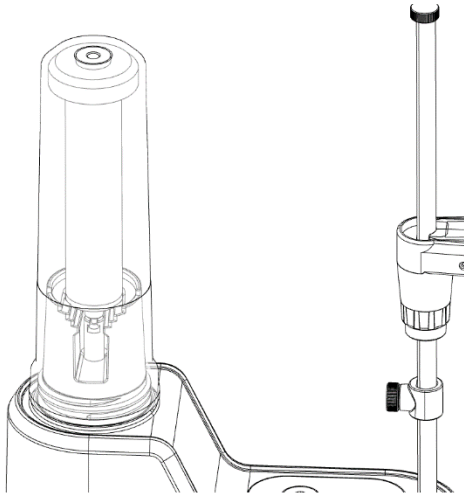
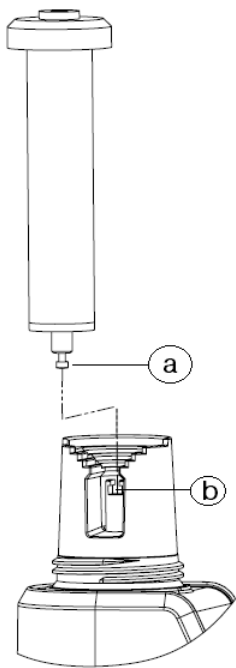
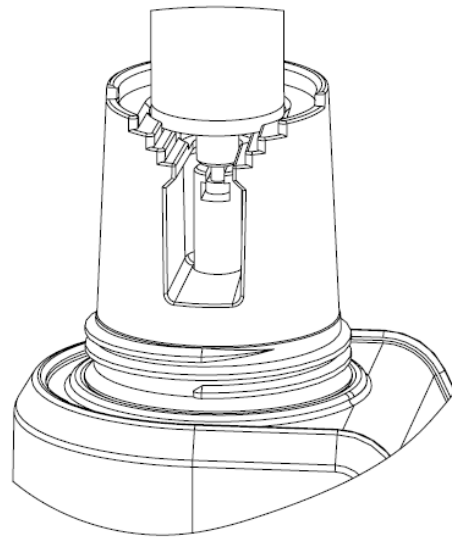

Figure 5. Positioning the Burette

1. Holding the center of the glass burette, gently align the piston ball on the bottom of burette (a) with the clasp on the titrator (b):



2. Seat the glass cylinder of the burette onto the alignment rings of the titrator by gently pressing down on the burette:



3. Place the burette cover over the burette, gently screw on the cover and ensure the top of the burette is aligned with the opening on the cover:

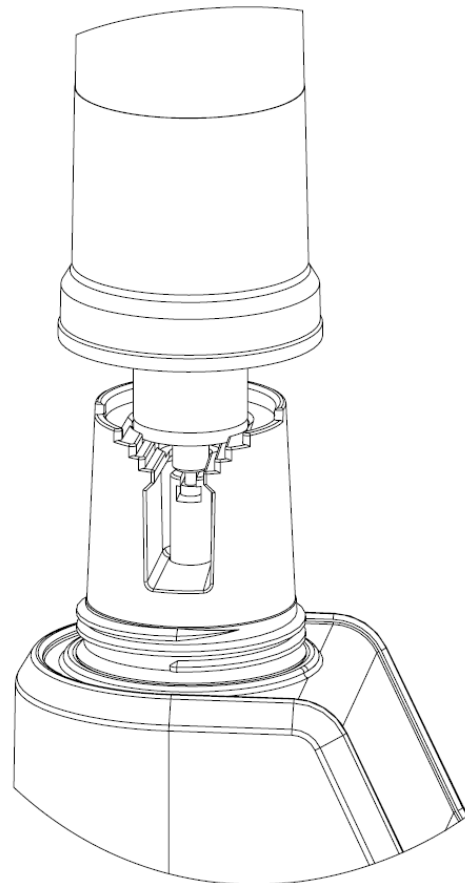

Installing the Tubing

Orion Star T900 series titrators include a standard tubing kit with three tubing sections – a burette to valve tubing with blue fittings, a reagent bottle cap to valve tubing with white fittings and dispenser probe to valve tubing with black fittings. The connection ports are shown in **Figure 6**.

1. Burette: Connect the tubing with blue fittings to the valve port labeled “burette” and the burette cap.
2. Bottle: Connect tubing with white fittings to the valve port labeled “bottle” and the reagent bottle cap.
3. Dispenser: Connect the tubing with black fittings to the valve port labeled “dispenser” and the dispenser probe.
4. See the [Titrant Preparation](#) section for instructions on how to prepare the titrator with the titrant.



Figure 6. Valve Connection Ports



Figure 7. Standard Tubing Set

Note: When replacing the tubing, always ensure that fittings are clean and free of debris prior to making connections with the titrator ports.

Installing Electrodes, Accessories and Devices

The back panel of titrator includes the connectors for the electrodes, probes, external devices and power supply. The ridge about these connectors is designed to protect the connectors from minor spills or leaks.

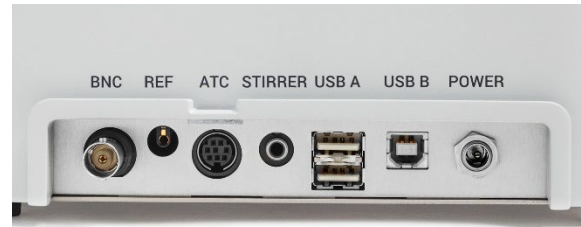

Figure 8. Titrator Back Panel Connectors

Connecting the Electrodes and Probes

1. Connect the sensing electrode to the BNC input.
2. If appropriate, connect the half-cell reference electrode to the REF input.
3. If appropriate, connect the ATC temperature probe to the ATC input.
4. Connect the stirrer probe to the STIRRER input.

Note: Care should be taken to properly use the locking feature on the ATC connector to lock on to the instrument housing.

For proper accuracy, the stirrer probe is required. The titrator includes an instrument-powered and instrument-controlled probe-style stirrer that should be connected to the 3.5 mm phono connector on the back panel of the titrator. The stirrer probe body should be placed into the middle position on the electrode holder arm. This arrangement of electrodes, dispensing probe and stirrer probe aids in effective stirring and accuracy. Stirrer speed is adjustable, depending on the sample characteristics and volume.

Connecting the Power Supply

The included power supply designed for universal use for voltage in the range 100-240 V AC, 50-60 Hz. The power supply consists of a universal power adapter and country specific AC power cords for US, EU, UK, AU and China.

1. Select the power cord that fits your regional power outlet and plug it into the IEC receptacle on the power adapter.

2. Connect the power supply to the POWER input on the back panel of the titrator.
3. Connect the power cord into the wall power outlet.

Note: Use of other power adapters can damage the titrator and will void the warranty.

Note: The use of a surge protector or uninterruptible power supply (UPS) is also recommended.

Connecting External Devices

Connect appropriate external devices to the USB A and USB B inputs on the back panel of the titrator.

1. Use the USB A connector to connect the titrator to the compact printer, catalog number STARA-106. After establishing physical connection with the printer using USB cable, the titrator will automatically detect the printer. No further setup is needed.
2. Use the USB A connector to connect the titrator to a USB flash drive. Methods can be imported and exported to a USB flash drive, data can be exported to a USB flash drive and titrator software updates can be imported from a USB flash drive.

Note: It is recommended to use a high-quality USB flash drive, such as the one included with the titrator, as a high-quality USB flash drive will make a tight-fitting, secure connection with the USB input on the titrator. To reorder the USB flash drive, use part number START-UM1.

3. Use the USB B connector on to connect the titrator to a computer using the included computer cable.
 - a. Download the Orion Star T900 series titrator computer software at www.thermofisher.com/orionsoftware.

Updating Titrator Software

Download the latest titrator software to access the latest features, enhancements and bug fixes for Thermo Scientific Orion Star T900 series titrators.

Note: Before installing a new software update on the titrator, make sure to backup and export all methods and data log files, as methods and data log files may be deleted from the titrator when the software update is performed.

1. Backup and export any saved methods to a USB flash drive. Export all data log files to a USB flash drive or printer.

2. Go to www.thermofisher.com/orionsoftware and download the latest version of the titrator software.
3. Save the titrator software to the root directory of a USB drive (not within a subfolder).
 - a. If the software is in a compressed/zipped format (.zip), extract/unzip the file and then save the software file to the USB drive.
 - b. Do not unzip/extract the actual titrator software (.swu or .tgz file format).

Note: It is recommended to use a high-quality USB flash drive, such as the one included with the titrator, to ensure a tight-fitting, secure connection with the titrator's USB input.

Note: The titrator must be at software version V2.10.0 to install the latest updates. If the titrator is at an earlier version, perform this procedure once to update to version V2.10.0 and a second time to update to version V3.0.0 or higher.

4. Insert the USB flash drive into the titrator.
5. Power on or restart the titrator and wait for the USB flash drive to mount with the titrator, indicated by the USB icon shown on the top of the titrator screen.
6. When prompted, press the "Update System" button.
 - a. For earlier software versions, manually start the update process: from the home screen, press the "General Settings" icon and then press the "Files and Info" button. Press the "Software Version" button and then press the "Check for Updates" button.
7. The update process will begin and take several minutes. Do not turn off the titrator during this time.
8. The titrator will automatically restart when the software update is complete.
 - a. Required system configuration changes will be applied on the first startup after the update is installed. During the configuration process, a sequence of three dots will be shown on the screen. This may take a few minutes. This is a one-time event and will not delay future restarts.
9. The titrator software update is now completed.

Chapter 3





Titrator Preparation

Instrument Setup Wizard

The first time the titrator is powered on, the Instrument Setup Wizard will be shown. Press the “Start Setup” button to initiate. The titrator will show general settings including language, time, date, temperature units and instrument name.

Titrator Home Screen

The left-side navigation area contains the icons for Back (navigation), Home, General Settings, Logs, Methods, Burette and Direct Measure:

Icon	Navigation
	The “Back” icon will navigate to the last displayed screen when it is active – it will be blue when active and grey when not active
	The “Home” icon will navigate back to the titrator home screen
	The “General Settings” icon will navigate to the general settings menu
	The “Logs” icon will navigate to the Titration, Titrant, Calibration and Direct Measure logs
	The “Methods” icon will navigate to the methods menu
	The “Burette” icon will navigate to the burette setup and maintenance menu
	The “Direct Measure” icon will navigate to the direct measure mode

The titrator home screen will display buttons and information appropriate for the current titrator conditions and settings, so not all buttons may be shown at all times.

For example, the first time the titrator is started, only the “Start a New Titration” button will be shown:

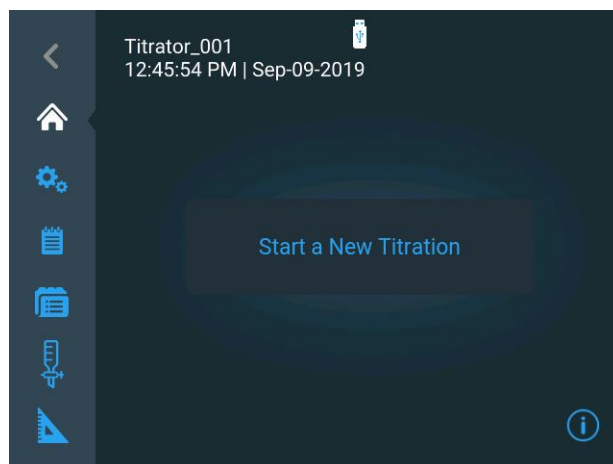

Once various titrator settings and actions are performed, the titrator home screen may look similar to this example:

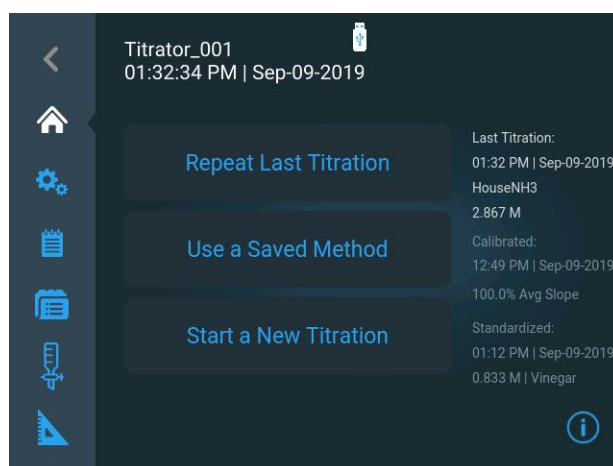

- The “Start a New Titration” button will access the step-by-step workflow for setting up a new titration, including setting electrode, titrant and titration parameters, which can then all be saved as a custom method.
 - See the [Titration Setup Wizard](#) section for detailed instructions on how to setup the titrator to run a sample titration.
- The “Repeat Last Titration” button will navigate directly to the Titration Pre-Check screen and the most recently used set of electrode, titrant and titration setup parameters, as well as electrode calibration and titrant standardization results (when appropriate), will be used to calculate the sample titration results.
- The “Use a Saved Method” button will navigate to the Methods section used to create, edit or run a method. Methods can also be imported from and exported to a USB flash drive.

- See the [Methods](#) section for instructions on using methods.
- Visit www.thermofisher.com/titrator for available application notes and corresponding preprogrammed method files that can be loaded onto the titrator.

electrode, titrant and titration parameters but the parameters are not saved as a method, the home screen will show direct links to the electrode, titrant and titration menus.

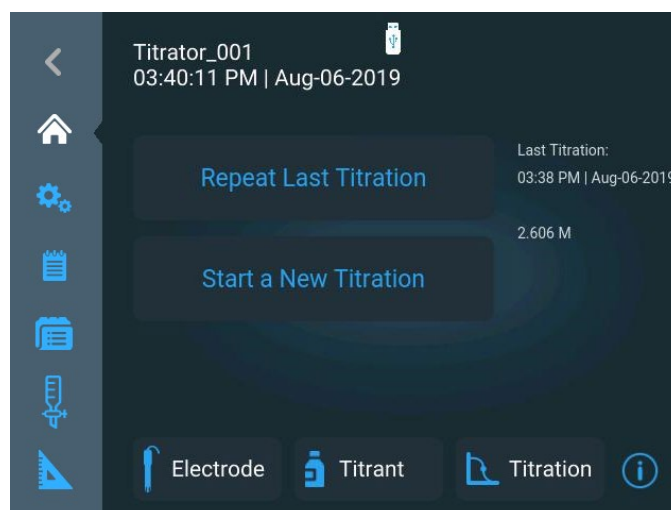

- The “Electrode” button will be shown and will navigate to the Electrode Setup section for an unsaved method
- The “Titrant” button will navigate to the Titrant Setup section for an unsaved method
- The “Titration” button will navigate to the Titration setup section for an unsaved method

The right-side navigation area will display the most recent titration data after a titration is performed, as well as electrode calibration data and titrant standardization data, when appropriate.



The lower right-hand corner of the home screen contains an “information” icon that provides screen-specific information and guidance.

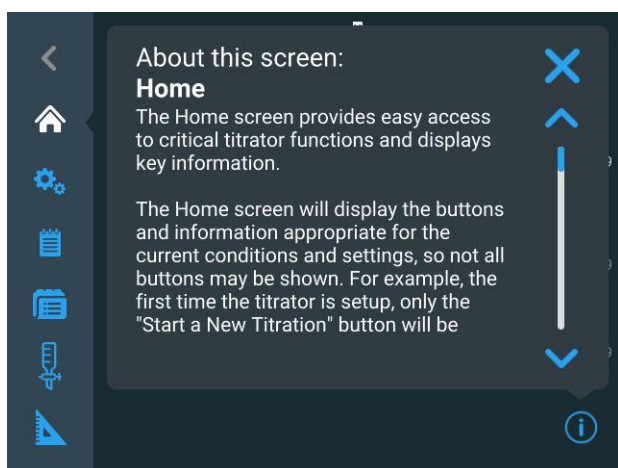

When the “Start a New Titration” button is used to set

Titration Preparation



1. Select and prepare the desired titrant.
 - a. Use the included GL38 bottle cap and plastic bottle, or the preferred titrant bottle and appropriate bottle cap.
 - b. Ensure the white bottle tubing is secured properly from the bottle cap to the labeled titrator valve input.
2. Place a waste beaker under the dispenser probe.
3. From the Home screen, press the “Burette” icon to access the Burette Setup and Maintenance screen.

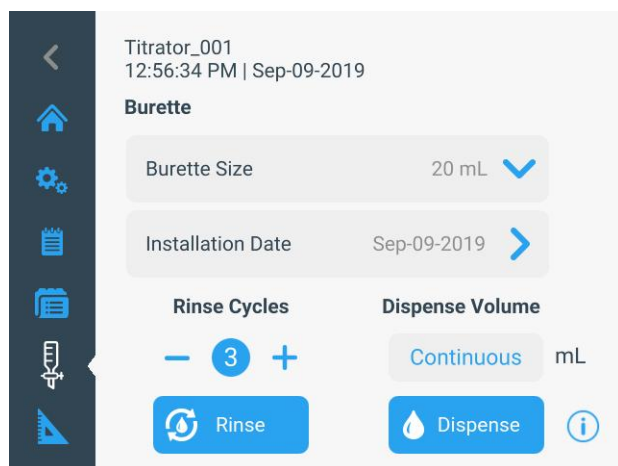

4. Perform 3-5 rinse cycles to flush the burette, tubing and dispenser probe with titrant before performing a titrant standardization or titration.

- a. In the “Rinse Cycles” section, press the – or + keys to adjust the number of rinse cycles and then press the “Rinse” button to start.
- b. The titrator will pull the titrant from the titrant bottle into the burette and then push the titrant from the burette into the dispenser probe and out into the waste beaker.

Note: While the rinse cycles are running, the “Rinse” button will update to show “Stop”. Press the “Stop” button at any time to abort the rinse cycles.

Changing the Titrant

When changing titrants, use the following procedure as a starting point and modifying depending on your requirements and the compatibility of existing and new titrants.

1. Disconnect the bottle tubing from the titrant bottle and leave the tubing disconnected and open to air.
 - a. Ensure the tubing is in a clean area, away from dirt or dust that may clog the tubing.
2. Perform 3 rinse cycles to remove the first titrant and flush the burette, tubing and dispenser with air.
3. Connect the bottle tubing to GL38 bottle cap and plastic bottle, or the preferred bottle, filled with deionized water.
4. Perform 3 rinse cycles to flush the burette, tubing and dispenser with deionized water.
5. Disconnect the bottle tubing from the titrant bottle and leave the tubing disconnected and open to air.
6. Perform 3 rinse cycles to flush the burette, tubing and dispenser with air.
7. Remove the burette from the titrator, in an appropriate location tip the burette upside down and gently shake as much of the remaining water out of the burette as possible and then reinstall the burette.
8. Connect the bottle tubing to GL38 bottle cap and plastic bottle, or the preferred bottle, filled with the new titrant.
9. Perform 3-5 rinse cycles to flush the burette, tubing and dispenser with the new titrant.

Titration Setup Wizard

From the Home screen, press the “Start a New Titration” button. The titrator will walk you through the setup parameters and actions needed to complete a titration.

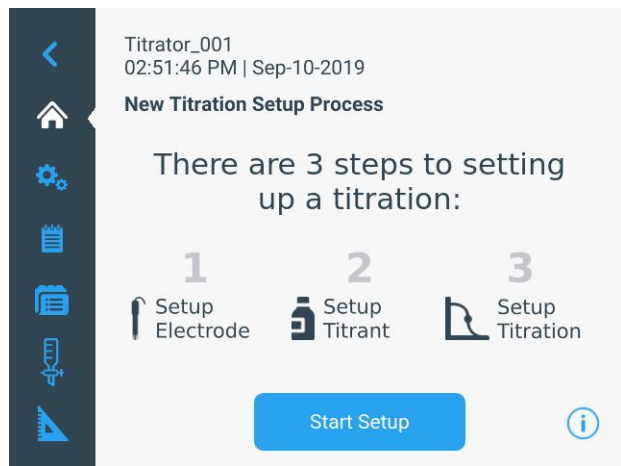

Step 1: Setup Electrode

Parameters related to the electrode are displayed and editable. Always scroll through the entire list of parameters when making changes, as the displayed parameters will update based on any changes made to previous parameters. Not all parameters in the following list may be shown on the titrator, depending on previous parameter selections.

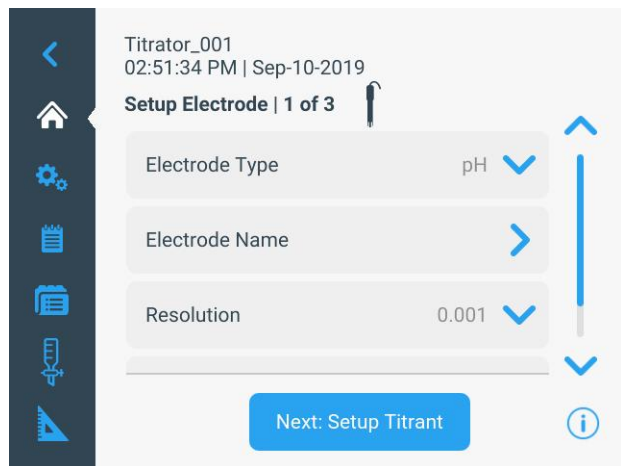

Orion Star T910 pH Titrator

- Electrode Name: Enter a name using up to 14 alphanumeric characters
- Resolution: Select 0.1, 0.01 or 0.001 pH resolution
- Buffer Group: Select USA (1.68, 4.01, 7.00, 10.01, 12.46) or DIN (1.68, 4.01, 6.86, 9.18) buffer groups for automatic buffer recognition during pH calibration

Orion Star T920 Redox Titrator

- Electrode Name: Enter a name using up to 14 alphanumeric characters

Orion Star T930 Ion Titrator

- Electrode Type: Select the analysis type to be done:
 - ISE-Titration = titration analysis using an ion selective electrode
 - ISE-MKA = Multiple Known Addition (MKA) analysis using an ion selective electrode
- ISE Type: Select the type of ion selective electrode that will be used for analysis from the displayed list, including generic ions such as X^- and X^+
- Electrode Name: Enter a name using up to 14 alphanumeric characters

Orion Star T940 All-in-One Titrator

- Electrode Type: Select the analysis type to be done:
 - pH = titration analysis using a pH electrode
 - Redox = titration analysis using a redox/ORP electrode
 - ISE-Titration = titration analysis using an ion selective electrode
 - ISE-MKA = Multiple Known Addition (MKA) analysis using an ion selective electrode
- Electrode Name: Enter a name using up to 14 alphanumeric characters
- If Electrode Type = pH
 - Resolution: Select 0.1, 0.01 or 0.001 pH resolution
 - Buffer Group: Select USA (1.68, 4.01, 7.00, 10.01, 12.46) or DIN (1.68, 4.01, 6.86, 9.18) buffer groups for automatic buffer recognition during pH calibration
- If Electrode Type = ISE-Titration or ISE-MKA
 - ISE Type: Select the type of ion selective electrode that will be used for analysis from the displayed list, including generic ions such as X^- and X^+

Step 2: Setup Titrant

Parameters related to the titrant are displayed and editable. Always scroll through the entire list of parameters when making changes, as the displayed parameters will update based on any changes made to previous parameters. Not all parameters in the following list may be shown on the titrator, depending on previous parameter selections.

Step 2: Setup Titrant Parameters for:

- Orion Star T910 pH Titrator
- Orion Star T920 Redox Titrator
- Orion Star T930 Ion and T940 All-in-One Titrators when Electrode Type = ISE-Titration

- Titrant Name: Select a common titrant from the list or select "User Defined" to enter the titrant name
 - Titrant Name: Enter the titrant name using up to 14 alphanumeric characters
 - In the User Defined Titrant Name entry field, the "back" icon can be used to return to the list of common titrants (entered name will not be saved)
- Titrant ID: Enter a titrant identification using up to 14 alphanumeric characters
 - Titrant ID can be useful to identify and track a titrant, such as entering the lot code
- Concentration Input Mode: Select how the concentration of the titrant will be determined
 - Manual Entry = enter the exact concentration of the titrant in M or mM
 - Standardization = run a titration to determine the exact concentration of the titrant using a known standard as the sample
- Titrant Concentration (Conc. Input Mode = Manual Entry): Enter the concentration value of the titrant in M or mM
- Nominal Concentration (Conc. Input Mode = Standardization): Enter the expected concentration value of the titrant to be standardized in M or mM
- Standardize Technique: Select Equivalence Point or Preset Endpoint as the titration type that will be used to determine the titrant concentration
- Number of Endpoints: Select 1 or 2 equivalence points or 1 preset endpoint
- Result Units: Select M or mM as the units displayed for the determined titrant concentration value
- Standardize Reaction Ratio: Enter the stoichiometric reaction value of the standard to titrant, as moles standard divided by moles titrant; see the [Calculating a Reaction Ratio](#) section for details.
- Standard Name: Select a common standard from the list or select "User Defined" to enter the standard name
 - Standard Name: Enter the standard name using up to 14 alphanumeric characters
 - In the User Defined Titrant Name entry field, the "back" icon can be used to return to the list of common titrants (entered name will not be saved)
- Standard Amount: Select how the amount of standard will be entered:
 - Select "Fixed Weight" or "Fixed Volume" if the amount of standard will be the same value for every standardization and then enter the standard amount value in grams for "Fixed Weight" or mL for "Fixed Volume"
 - Select "Variable Weight" or "Variable Volume" if the amount of standard will be different for each standardization, the titrator will prompt you to enter for the standard amount value before each standardization
- Standard Molecular Weight: Enter the molecular weight of the chemical used as the standard

- Standard Purity: Enter the percent purity of the chemical used as the standard
- Standard Concentration: Enter the concentration of the chemical used as the standard in M or mM
- Pre-dose Titrant Volume: Enter a volume of titrant to be added to the standard before the titration begins to shorten titration time when the endpoint volume is well known
- Maximum Total Titrant Volume: Enter the maximum amount of titrant to be added during the titration as a safety feature to stop the analysis if the endpoint is not detected
- Standardization Process Control: Select optimized settings for “Routine”, “Quick” or “Careful” endpoint determination for the standardization titration or customize settings for detecting the endpoint using the “User Defined” option
 - Routine – Select to run a moderate-paced titration with better endpoint determination using average doses of titrant, average time per dose and average stability criteria
 - Quick – Select to run a fast-paced titration with good endpoint determination using larger doses of titrant, shorter time per dose and less rigid stability criteria
 - Careful – Select to run a slow-paced titration with best endpoint determination using smaller doses of titrant, longer time per dose and strict stability criteria
 - User Defined – Set mV change per dose (ΔE), minimum and maximum volumes per dose (ΔV_{\min} and ΔV_{\max}), mV per minute stability criteria (dE/dt), minimum and maximum time per dose (t_{\min} and t_{\max}) and minimum mV per mL value at the equivalence point (threshold) for uncommon or hard-to-detect endpoint determinations
- Pre-stir Duration: Enter the time in seconds to stir the solution prior to the start of the titration to ensure thorough mixing of the standard before analysis
- Stir speed: Select the speed of the stirrer probe as “Very Slow”, “Slow”, “Medium”, “Fast” or “Very Fast” to mix the solution thoroughly without causing a vortex, bubbles or splashes

Step 2: Setup Titrant Parameters for:

- Orion Star T930 Ion and T940 All-in-One Titrators when Electrode Type = ISE-MKA

- Titrant Name: Select a common MKA titrant standard from the list or select "User Defined" to enter the MKA standard name
 - Titrant Name: Enter the MKA standard name using up to 14 alphanumeric characters
 - In the User Defined Titrant Name entry field, the “back” icon can be used to return to the list of common MKA standards (entered name will not be saved)
- Titrant ID: Enter a MKA titrant standard identification using up to 14 alphanumeric characters
 - Titrant ID can be useful to identify and track a standard, such as entering the lot code
- Titrant Concentration: Enter the concentration value of the MKA titrant standard in mg/L, M or mM
- Titrant Molecular Weight: Enter the molecular weight of the chemical used as the MKA titrant standard

Step 3: Setup Titration

Parameters related to the sample titration are displayed and editable. Always scroll through the entire list of parameters when making changes, as the displayed parameters will update based on any changes made to previous parameters. Not all parameters in the following list may be shown on the titrator, depending on previous parameter selections.

Step 3: Setup Titration Parameters for:

- Orion Star T910 pH Titrator
- Orion Star T920 Redox Titrator
- Orion Star T930 Ion and T940 All-in-One Titrators when Electrode Type = ISE-Titration

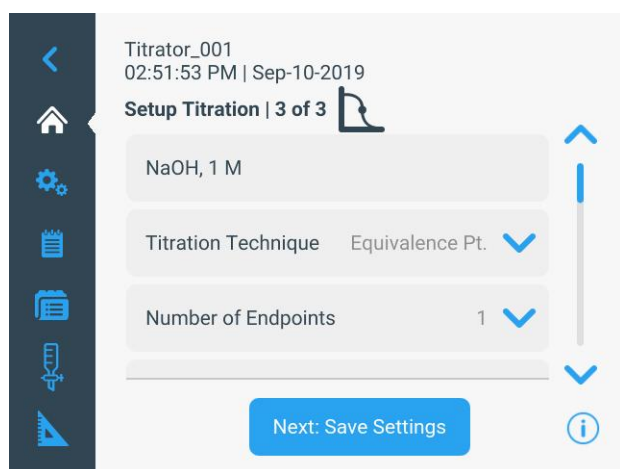

The screenshot shows a mobile application interface for setting up a titration. At the top, it displays 'Titrator_001' and the time '02:51:53 PM | Sep-10-2019'. The main heading is 'Setup Titration | 3 of 3'. Below this, there are three input fields: 'NaOH, 1 M', 'Titration Technique' set to 'Equivalence Pt.', and 'Number of Endpoints' set to '1'. A blue button at the bottom says 'Next: Save Settings'. A vertical scrollbar is on the right side of the form.

- The titrant information is shown for reference only
- Titration Technique: Select Equivalence Point or Preset Endpoint as the titration type that will be used to determine the sample concentration
- Number of Endpoints: Select 1 or 2 equivalence points or select 1, 2 or 3 preset endpoints
- Endpoint Values: If Preset Endpoint is selected, enter the values of the endpoints
- Display Units: For pH titrations only, select pH or mV as the units to be displayed for the endpoint value with endpoint volume and calculated concentration
- Titration Type: Select Direct Titration or Back Titration as the titration type that will be used to determine the sample concentration
 - If Back Titration is selected, the following parameters will be shown, some dependent on previous parameter selections:
 - Reagent Reaction Ratio

- Titrant Reaction Ratio
- Reagent Amount
- Reagent Molecular Weight
- Reagent Purity
- Reagent Weight
- Reagent Volume
- Reagent Concentration

- Blank Required: Select No, Fixed or Variable for the blank value entry method
 - Select No if no blank is required
 - Select Fixed if the blank value is already known and enter the blank amount in mmol
 - Select Variable to analyze one or more blanks to determine the blank value, the titrator will display the “Run a Blank” button on the Titration Pre-Check screen – use this button to run a blank titration as needed before sample titrations
- Result Units: Select the units from the list that will be used for the sample concentration results; see the [Selecting the Result Units](#) section for details
 - For F * consumption mmol: Enter a value for the factor and the entered factor value will be multiplied by the resulting millimoles consumed during the sample titration
- Reaction Ratio: Enter the stoichiometric reaction value of the sample to titrant, as moles sample divided by moles titrant; see the [Calculating a Reaction Ratio](#) section for details.
- Sample Molecular Weight: Enter the molecular weight of the chemical used as the sample
- Sample Amount: Select how the amount of sample will be entered:
 - Select “Fixed Weight” or “Fixed Volume” if the amount of sample will be the same value for every titration and then enter the sample amount value in grams for “Fixed Weight” or mL for “Fixed Volume”
 - Select “Variable Weight” or “Variable Volume” if the amount of sample will be different for each titration, the titrator will

prompt you to enter for the sample amount value before each titration

- Sample Density: Enter the density of the sample
- Pre-dose Titrant Volume: Enter a volume of titrant to be added to the sample before the titration begins to shorten titration time when the endpoint volume is well known
- Maximum Total Titrant Volume: Enter the maximum amount of titrant to be added during the titration as a safety feature to stop the analysis if the endpoint is not determined
- Titration Process Control: Select optimized settings for “Routine”, “Quick” or “Careful” endpoint determination for the sample titration or customize settings for detecting the endpoint using the “User Defined” option
 - Routine – Select to run a moderate-paced titration with better endpoint determination using average doses of titrant, average time per dose and average stability criteria
 - Quick – Select to run a fast-paced titration with good endpoint determination using larger doses of titrant, shorter time per dose and less rigid stability criteria
 - Careful – Select to run a slow-paced titration with best endpoint determination using smaller doses of titrant, longer time per dose and strict stability criteria
 - User Defined – Set mV change per dose (ΔE), minimum and maximum volumes per dose (ΔV_{\min} and ΔV_{\max}), mV per minute stability criteria (dE/dt), minimum and maximum time per dose (t_{\min} and t_{\max}) and minimum mV per mL value at the equivalence point (threshold) for uncommon or hard-to-detect endpoint determinations
- Pre-stir Duration: Enter the time in seconds to stir the solution prior to the start of the titration to ensure thorough mixing of the sample before analysis
- Stir speed: Select the speed of the stirrer probe as “Very Slow”, “Slow”, “Medium”, “Fast” or “Very Fast” to mix the solution thoroughly without causing a vortex, bubbles or splashes

- Sample ID: Select None, Auto-Incremental or Manual for the sample identification option
 - For Auto-Incremental Sample ID: enter up to 11 alphanumeric characters and three number places will be added that will automatically increase with each titration run, beginning with 001
 - For Manual Sample ID: the titrator will prompt you to enter for the sample ID value before each titration

The titrator will display the option to save the electrode, titrant and titration parameters as a method. We recommend saving the settings as a method so the same parameters can be easily accessed as needed.

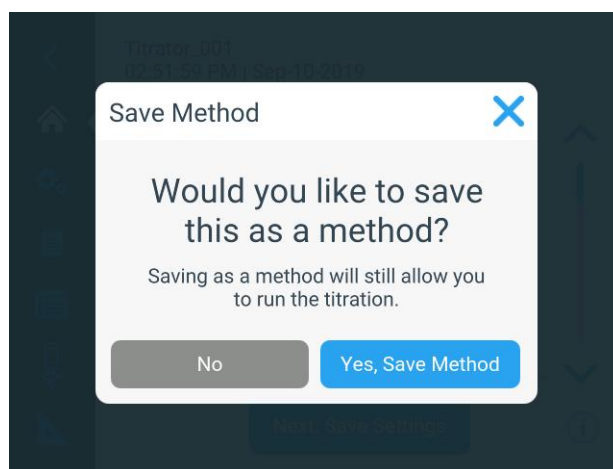

Step 3: Setup Titration Parameters for:

- Orion Star T930 Ion and T940 All-in-One Titrators when Electrode Type = ISE-MKA

- The MKA standard information is shown for reference only
- Result Units: Select the units from the list that will be used for the sample concentration results; see the [Selecting the Result Units](#) section for details
- Sample Amount: Select how the amount of sample will be entered:
 - Select “Fixed Weight” or “Fixed Volume” if the amount of sample will be the same value for every titration and then enter the sample amount value in grams for “Fixed Weight” or mL for “Fixed Volume”
 - Select “Variable Weight” if the amount of sample will be different for each titration, the titrator will prompt you to enter for the sample amount value before each titration
- Sample Density: Enter the density of the sample
- Total Solution Volume: Enter the total volume of the prepared sample in mL, including the sum of the sample volume, ISA volume, reagent volume, etc.
- Maximum Total Titrant Volume: Enter the maximum amount of MKA standard to be added during the titration as a safety feature to stop the analysis if the MKA result is not determined
- Blank Concentration Required: Select No or Manual Entry for the blank value.
 - Select No if no blank is required
 - If Manual Entry is selected, enter the blank value in M that will be used for every sample
- MKA Process Control: Select optimized settings for “Routine”, “Quick” or “Careful” sample concentration determination for the titration or customize settings for detecting the sample concentration using the “User Defined” option
 - Routine – Select to run a moderate-paced titration with better sample concentration determination using average doses of MKA standard, average time allowed per dose and average stability criteria
 - Quick – Select to run a fast-paced titration with good sample concentration determination using larger doses of MKA standard, shorter time allowed per dose and less rigid stability criteria
 - Careful – Select to run a slow-paced titration with best sample concentration determination using smaller doses of MKA standard, longer time allowed per dose and strict stability criteria
 - User Defined – Set mV constant increments, mV per minute measurement stability, minimum and maximum time per dose (t_{min} and t_{max}) and minimum and maximum volumes per dose (ΔV_{min} and ΔV_{max}) for uncommon or hard-to-detect MKA sample concentration determinations
- Precision Level: Enter the required precision level used to determine when the MKA sample concentration analysis is complete
- Pre-stir Duration: Enter the time in seconds to stir the solution prior to the start of the titration to ensure thorough mixing of the sample before analysis
- Stir speed: Select the speed of the stirrer probe as “Very Slow”, “Slow”, “Medium”, “Fast” or “Very Fast” to mix the solution thoroughly without causing a vortex, bubbles or splashes
- Sample ID: Select None, Auto-Incremental or Manual for the sample identification option
 - For Auto-Incremental Sample ID: enter up to 11 alphanumeric characters and three number places will be added that will

automatically increase with each titration run, beginning with 001

- For Manual Sample ID: the titrator will prompt you to enter for the sample ID value before each titration

The titrator will display the option to save the electrode, titrant and titration parameters as a method. We recommend saving the settings as a method so the same parameters can be easily accessed as needed.

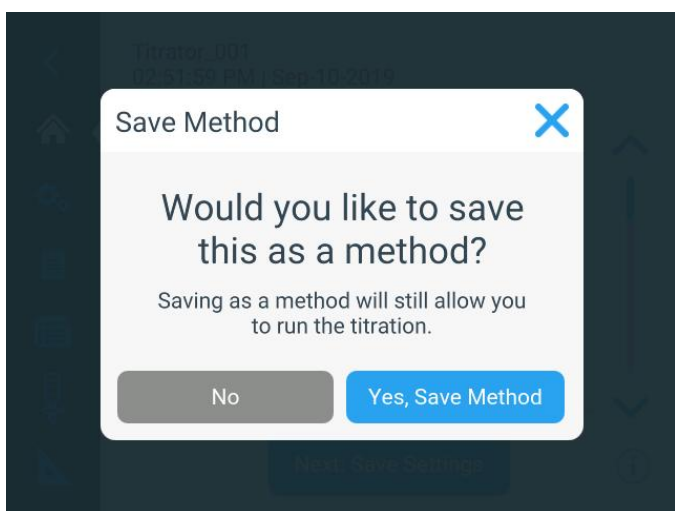

Example Parameter Settings from App Notes

The following tables show examples of the electrode, titrant and titration setup parameters from existing application notes with preprogrammed methods. These examples are intended to serve as a guide for creating custom methods.

To perform any of the titrations listed here, download the complete application note at www.thermofisher.com/titrator. These application notes contain required materials lists, sample preparation requirements, full titration instructions and helpful tips for performing successful titrations using the method parameters listed here.

T1 TitraAcidity Method:

The following setup parameters are recommended for performing a titratable acidity titration of orange juice (0.5 to 2% acid by weight as citric acid) using the Orion Star T910 pH titrator or Orion Star T940 all-in-one titrator. Visit www.thermofisher.com/titrator to download the complete application note with full instructions and recommendations.

T1 TitraAcidity Method	
Electrode	Parameter
Electrode Type	pH
Electrode Name	Edit as desired
Resolution	0.01
Buffer Group	USA
Titrant	Parameter
Titrant Name	NaOH
Titrant ID	Edit as desired
Conc. Input Mode	Standardization
Nominal Concentration	0.1 M
Standardize Tech.	Equivalence Pt.
Number of Endpoints	1
Results Units	M
Standardize Reaction Ratio	1
Standard Name	KHP
Standard Amount	Variable Weight
Standard Molecular Wt	204.2 g/mol
Standard Purity	100%
Pre-dose Titrant Volume	0 mL
Max. Total Titrant Volume	5 mL
Stand. Process Control	Routine
Pre-stir Duration	5 sec
Stir Speed	Fast

Titration	Parameter
Titration Technique	Preset End Pt.
Number of Endpoints	1
Endpoint Values	8.2
Display Units	pH
Titration Type	Direct Titration
Blank Required	No
Result Units	% w/w
Reaction Ratio	0.333
Sample Mol. Wt.	192.1 g/mol
Sample Amount	Variable Weight
Pre-dose Titrant Volume	0 mL
Max total titrant volume	10 mL
Titration Process Control	Routine
Pre-stir Duration	5 sec
Stir Speed	Fast
Sample ID	Manual

T1 TitraAcidity Method with Manual Titrant Concentration Input:

If the titrant has a certified concentration and manual input of the titrant concentration is preferred, the method can be modified to this:

T1 TitraAcidity Method (Modified)	
Electrode	Parameter
Electrode Type	pH
Electrode Name	Edit as desired
Resolution	0.01
Buffer Group	USA
Titrant	Parameter
Titrant Name	NaOH
Titrant ID	Edit as desired
Conc. Input Mode	Manual Entry
Titrant Concentration	0.1 M
Titration	Parameter
Titration Technique	Preset End Pt.
Number of Endpoints	1
Endpoint Values	8.2
Display Units	pH
Titration Type	Direct Titration
Blank Required	No
Result Units	% w/w
Reaction Ratio	0.333
Sample Mol. Wt.	192.1 g/mol
Sample Amount	Variable Weight

Pre-dose Titrant Volume	0 mL
Max total titrant volume	10 mL
Titration Process Control	Routine
Pre-stir Duration	5 sec
Stir Speed	Fast
Sample ID	Manual

T2 TotAlkalinity Method:

The following setup parameters are recommended for performing a total alkalinity titration of water (25 to 1000 mg/L total alkalinity as CaCO₃) using the Orion Star T910 pH titrator or Orion Star T940 all-in-one titrator. Visit www.thermofisher.com/titrator to download the complete application note with full instructions and recommendations.

T2 TotAlkalinity Method	
Electrode	Parameter
Electrode Type	pH
Electrode Name	Edit as desired
Resolution	0.01
Buffer Group	USA
Titrant	Parameter
Titrant Name	HCl
Titrant ID	Edit as desired
Conc. Input Mode	Standardization
Nominal Concentration	0.1 M
Standardize Tech.	Equivalence Pt.
Number of Endpoints	1
Results Units	M
Standardize Reaction Ratio	1
Standard Name	THAM (Tris)
Standard Amount	Variable Weight
Standard Molecular Wt	121.14 g/mol
Standard Purity	100%
Pre-dose Titrant Volume	0 mL
Max. Total Titrant Volume	15 mL
Stand. Process Control	Routine
Pre-stir Duration	5 sec
Stir Speed	Fast
Titration	Parameter
Titration Technique	Preset End Pt.
Number of Endpoints	1
Endpoint Values	4.5
Display Units	pH
Titration Type	Direct Titration
Blank Required	No

Result Units	mg/L
Reaction Ratio	0.5
Sample Mol. Wt.	100.09 g/mol
Sample Amount	Fixed Volume, 100 mL
Pre-dose Titrant Volume	0.05 mL
Max total titrant volume	20 mL
Titration Process Control	Routine
Pre-stir Duration	5 sec
Stir Speed	Fast
Sample ID	Manual

If the titrant has a certified concentration and manual input of the titrant concentration is preferred, the method can be modified similar to the example in the [T1 TitrAcidity Method with Manual Titrant Concentration Input](#) section.

T3 TAN Method:

The following setup parameters are recommended for performing a total acid number (TAN) titration of petroleum products (0.1 to 150 mg KOH/g, when using 0.1M KOH in IPA titrant) using the Orion Star T910 pH titrator or Orion Star T940 all-in-one titrator. Visit www.thermofisher.com/titrator to download the complete application note with full instructions and recommendations.

T3 TAN Method	
Electrode	Parameter
Electrode Type	pH
Electrode Name	Edit as desired
Resolution	0.01
Buffer Group	USA
Titrant	Parameter
Titrant Name	NaOH_IPA
Titrant ID	Edit as desired
Conc. Input Mode	Standardization
Nominal Concentration	0.1 M
Standardize Tech.	Equivalence Pt.
Number of Endpoints	1
Results Units	M
Standardize Reaction Ratio	1
Standard Name	KHP
Standard Amount	Variable Weight
Standard Molecular Wt	204.2 g/mol
Standard Purity	100%
Pre-dose Titrant Volume	2 mL
Max. Total Titrant Volume	8 mL

Stand. Process Control	Routine
Pre-stir Duration	5 sec
Stir Speed	Medium
Titration	Parameter
Titration Technique	Preset End Pt.
Number of Endpoints	1
Endpoint Values	11
Display Units	pH
Titration Type	Direct Titration
Blank Required	Variable
Result Units	TAN
Reaction Ratio	1
Sample Amount	Variable Weight
Pre-dose Titrant Volume	0 mL
Max total titrant volume	6 mL
Titration Process Control	Routine
Pre-stir Duration	20 sec
Stir Speed	Fast
Sample ID	Manual

If the titrant has a certified concentration and manual input of the titrant concentration is preferred, the method can be modified similar to the example in the [T1 TitrAcidity Method with Manual Titrant Concentration Input](#) section.

T4 TBN Back Method:

The following setup parameters are recommended for performing a total base number (TBN) back titration of petroleum products (up to 300 mg KOH/g, when using 0.1 M standard PCA reagent) using the Orion Star T910 pH titrator or Orion Star T940 all-in-one titrator. Visit www.thermofisher.com/titrator to download the complete application note with full instructions and recommendations.

T4 TBN Back Method	
Electrode	Parameter
Electrode Type	pH
Electrode Name	Edit as desired
Resolution	0.001
Buffer Group	USA
Titrant	Parameter
Titrant Name	Acetate in GAA
Titrant ID	Edit as desired
Conc. Input Mode	Standardization
Nominal Concentration	0.1 M
Standardize Tech.	Equivalence Pt.

Number of Endpoints	1
Results Units	M
Standardize Reaction Ratio	1
Standard Name	PCA
Standard Amount	Fixed Volume, 4 mL
Standard Concentration	0.1 M (or true value)
Pre-dose Titrant Volume	2 mL
Max. Total Titrant Volume	6 mL
Stand. Process Control	Routine
Pre-stir Duration	20 sec
Stir Speed	Fast
Titration	Parameter
Titration Technique	Equivalence Pt.
Number of Endpoints	1
Display Units	mV
Titration Type	Back
Result Units	TBN
Reagent Reaction Ratio	1
Titrant Reaction Ratio	1
Reagent Amount	Manual Volume
Reagent Concentration	0.1 M (or true value)
Reagent Volume	4 mL
Sample Amount	Variable Weight
Pre-dose Titrant Volume	0.1 mL
Max total titrant volume	5 mL
Titration Process Control	Routine
Pre-stir Duration	60 sec
Stir Speed	Fast
Sample ID	Manual

If the titrant has a certified concentration and manual input of the titrant concentration is preferred, the method can be modified similar to the example in the [T1 TitraAcidity Method with Manual Titrant Concentration Input](#) section.

T5 SO2 Wine Method:

The following setup parameters are recommended for performing free and total sulfur dioxide titrations of wine (25 to 250 mg/L of SO₂) using the Orion Star T920 redox titrator or Orion Star T940 all-in-one titrator. Visit www.thermofisher.com/titrator to download the complete application note with full instructions and recommendations.

T5 SO2 Wine Method	
Electrode	Parameter
Electrode Type	Redox

Electrode Name	Edit as desired
Titrant	Parameter
Titrant Name	I2
Titrant ID	Edit as desired
Conc. Input Mode	Standardization
Nominal Concentration	0.01 M
Standardize Tech.	Equivalence Pt.
Number of Endpoints	1
Results Units	M
Standardize Reaction Ratio	2
Standard Name	Na2S2O3
Standard Amount	Fixed Volume, 10 mL
Standard Concentration	0.01 M
Pre-dose Titrant Volume	4 mL
Max. Total Titrant Volume	10 mL
Stand. Process Control	User Defined
ΔE	10 mV
ΔV_{min}	0.02 mL
ΔV_{max}	0.10 mL
dE/dt	10 mV/min
Tmin	2 sec
Tmax	8 sec
Threshold	250 mV/mL
Pre-stir Duration	5 sec
Stir Speed	Medium
Titration	Parameter
Titration Technique	Equivalence Pt.
Number of Endpoints	1
Titration Type	Direct Titration
Blank Required	No
Result Units	mg/L
Reaction Ratio	1
Sample Mol. Wt.	64.07 g/mol
Sample Amount	Fixed Volume, 25 mL
Pre-dose Titrant Volume	0.1 mL
Max total titrant volume	10 mL
Titration Process Control	User Defined
ΔE	5 mV
ΔV_{min}	0.02 mL
ΔV_{max}	0.10 mL
dE/dt	10 mV/min
Tmin	2 sec
Tmax	4 sec
Threshold	250 mV/mL
Pre-stir Duration	10 sec
Stir Speed	Medium

Sample ID	Manual
-----------	--------

If the titrant has a certified concentration and manual input of the titrant concentration is preferred, the method can be modified similar to the example in the [T1 TitraAcidity Method with Manual Titrant Concentration Input](#) section.

T6 Salt Food Method:

The following setup parameters are recommended for performing salt (sodium chloride) content of food titrations by weight or by volume (0.5 to 20% w/w sodium chloride, when using 0.1 M silver titrant) using the Orion Star T930 ion titrator or Orion Star T940 all-in-one titrator. Visit www.thermofisher.com/titrator to download the complete application note with full instructions and recommendations.

T6 Salt Food Method	
Electrode	Parameter
Electrode Type	ISE-Titration
ISE Type	Silver (Ag+)
Electrode Name	Edit as desired
Titrant	Parameter
Titrant Name	AgNO ₃
Titrant ID	Edit as desired
Conc. Input Mode	Standardization
Nominal Concentration	0.1 M
Standardize Tech.	Equivalence Pt.
Number of Endpoints	1
Results Units	M
Standardize Reaction Ratio	1
Standard Name	KCl
Standard Amount	Fixed Volume, 2 mL
Standard Concentration	0.1 M
Pre-dose Titrant Volume	0 mL
Max. Total Titrant Volume	5 mL
Stand. Process Control	Routine
Pre-stir Duration	5 sec
Stir Speed	Medium
Titration	Parameter
Titration Technique	Equivalence Pt.
Number of Endpoints	1
Titration Type	Direct Titration
Blank Required	No
Result Units	% w/w (or % w/v)
Reaction Ratio	1
Sample Mol. Wt.	58.44 g/mol

Sample Amount	Variable Weight (or Variable Volume)
Pre-dose Titrant Volume	0 mL
Max total titrant volume	10 mL
Titration Process Control	Routine
Pre-stir Duration	5 sec
Stir Speed	Medium
Sample ID	Manual

If the titrant has a certified concentration and manual input of the titrant concentration is preferred, the method can be modified similar to the example in the [T1 TitraAcidity Method with Manual Titrant Concentration Input](#) section.

T7A Total Hard Method:

The following setup parameters are recommended for performing total hardness titrations of water (20 to 500 mg/L of hardness as mg/L CaCO₃ when using 0.01 M EDTA titrant) using the Orion Star T930 ion titrator or Orion Star T940 all-in-one titrator. Visit www.thermofisher.com/titrator to download the complete application note with full instructions and recommendations.

T7A Total Hard Method	
Electrode	Parameter
Electrode Type	ISE-Titration
ISE Type	Calcium (Ca ²⁺)
Electrode Name	Edit as desired
Titrant	Parameter
Titrant Name	EDTA
Titrant ID	Edit as desired
Conc. Input Mode	Standardization
Nominal Concentration	10 mM
Standardize Tech.	Equivalence Pt.
Number of Endpoints	1
Results Units	mM
Standardize Reaction Ratio	1
Standard Name	Calcium
Standard Amount	Fixed Volume, 1 mL
Standard Concentration	0.1 M
Pre-dose Titrant Volume	8 mL
Max. Total Titrant Volume	16 mL
Stand. Process Control	Routine
Pre-stir Duration	10 sec
Stir Speed	Fast
Titration	Parameter

Titration Technique	Equivalence Pt.
Number of Endpoints	1
Titration Type	Direct Titration
Blank Required	No
Result Units	mg/L
Reaction Ratio	1
Sample Mol. Wt.	100.1 g/mol
Sample Amount	Variable Volume
Pre-dose Titrant Volume	1.8 mL
Max total titrant volume	4 mL
Titration Process Control	User Defined
ΔE	15 mV
ΔV_{min}	0.10 mL
ΔV_{max}	0.10 mL
dE/dt	10 mV/min
Tmin	2 sec
Tmax	10 sec
Threshold	100 mV/mL
Pre-stir Duration	10 sec
Stir Speed	Fast
Sample ID	Manual

If the titrant has a certified concentration and manual input of the titrant concentration is preferred, the method can be modified similar to the example in the [T1 TitraAcidity Method with Manual Titrant Concentration Input](#) section.

T8 Chloride Water Method:

The following setup parameters are recommended for performing chloride titrations of water (5 to 500 mg/L chloride when using 0.01 M silver nitrate titrant) using the Orion Star T930 ion titrator or Orion Star T940 all-in-one titrator. Visit www.thermofisher.com/titrator to download the complete application note with full instructions and recommendations.

T8 Chloride Water Method	
Electrode	Parameter
Electrode Type	ISE-Titration
ISE Type	Silver (Ag+)
Electrode Name	Edit as desired
Titrant	Parameter
Titrant Name	AgNO3
Titrant ID	Edit as desired
Conc. Input Mode	Standardization
Nominal Concentration	0.01 M

Standardize Tech.	Equivalence Pt.
Number of Endpoints	1
Results Units	mM
Standardize Reaction Ratio	1
Standard Name	Chloride
Standard Amount	Fixed Volume, 1 mL
Standard Concentration	0.02821 M
Pre-dose Titrant Volume	1 mL
Max. Total Titrant Volume	5 mL
Stand. Process Control	User Defined
ΔE	10 mV
ΔV_{min}	0.05 mL
ΔV_{max}	0.30 mL
dE/dt	8 mV/min
Tmin	2 sec
Tmax	8 sec
Threshold	50 mV/mL
Pre-stir Duration	5 sec
Stir Speed	Fast
Titration	Parameter
Titration Technique	Equivalence Pt.
Number of Endpoints	1
Titration Type	Direct Titration
Blank Required	No
Result Units	mg/L
Reaction Ratio	1
Sample Mol. Wt.	35.45 g/mol
Sample Amount	Variable Volume
Pre-dose Titrant Volume	1 mL
Max total titrant volume	5 mL
Titration Process Control	User Defined
ΔE	10 mV
ΔV_{min}	0.05 mL
ΔV_{max}	0.30 mL
dE/dt	8 mV/min
Tmin	2 sec
Tmax	8 sec
Threshold	50 mV/mL
Pre-stir Duration	5 sec
Stir Speed	Fast
Sample ID	Manual

If the titrant has a certified concentration and manual input of the titrant concentration is preferred, the method can be modified similar to the example in the [T1 TitraAcidity Method with Manual Titrant Concentration Input](#) section.

T9 Na Veg Method:

The following setup parameters are recommended for performing sodium multiple known addition (MKA) analysis of canned vegetables (100 to 1000 mg sodium/100g, when using 1M sodium KAP standard titrant) using the Orion Star T930 ion titrator or Orion Star T940 all-in-one titrator. Visit www.thermofisher.com/titrator to download the complete application note with full instructions and recommendations.

T9 Na Veg Method	
Electrode	Parameter
Electrode Type	ISE-MKA
ISE Type	Sodium (Na+)
Electrode Name	Edit as desired
Titrant	Parameter
Titrant Name	Sodium (Na+)
Titrant ID	Edit as desired
Titrant Concentration	1 M
Titration	Parameter
Result Units	mg/100g
Sample Mol. Wt.	22.99 g/mol
Sample Amount	Variable Weight
Total Solution Volume	55 mL
Max total titrant volume	20 mL
Blank Conc. Required	No
MKA Process Control	Routine
Precision Level	2 %
Pre-stir Duration	10 sec
Stir Speed	Fast
Sample ID	Manual

T10 Ca Hard Method:

The following setup parameters are recommended for performing calcium hardness titrations of water (15 to 500 mg/L of hardness as mg/L CaCO₃ when using 0.01 M EDTA titrant) using the Orion Star T930 ion titrator or Orion Star T940 all-in-one titrator. Visit www.thermofisher.com/titrator to download the complete application note with full instructions and recommendations.

T10 Ca Hard Method	
Electrode	Parameter
Electrode Type	ISE-Titration
ISE Type	Calcium (Ca ²⁺)
Electrode Name	Edit as desired

Titrant	Parameter
Titrant Name	EDTA
Titrant ID	Edit as desired
Conc. Input Mode	Standardization
Nominal Concentration	10 mM
Standardize Tech.	Equivalence Pt.
Number of Endpoints	1
Results Units	mM
Standardize Reaction Ratio	1
Standard Name	Calcium
Standard Amount	Fixed Volume, 1 mL
Standard Concentration	0.1 M
Pre-dose Titrant Volume	8 mL
Max. Total Titrant Volume	16 mL
Stand. Process Control	Routine
Pre-stir Duration	10 sec
Stir Speed	Fast
Titration	Parameter
Titration Technique	Equivalence Pt.
Number of Endpoints	1
Titration Type	Direct Titration
Blank Required	No
Result Units	mg/L
Reaction Ratio	1
Sample Mol. Wt.	100.1 g/mol
Sample Amount	Variable Volume
Pre-dose Titrant Volume	2 mL
Max total titrant volume	4 mL
Titration Process Control	User Defined
ΔE	15 mV
ΔVmin	0.05 mL
ΔVmax	0.05 mL
dE/dt	10 mV/min
Tmin	2 sec
Tmax	10 sec
Threshold	100 mV/mL
Pre-stir Duration	10 sec
Stir Speed	Fast
Sample ID	Manual

If the titrant has a certified concentration and manual input of the titrant concentration is preferred, the method can be modified similar to the example in the [T1 TitraAcidity Method with Manual Titrant Concentration Input](#) section.

General Settings

The General Settings screen will display a list of titrator settings for Diagnostics, Display, Files and Info and Notifications.

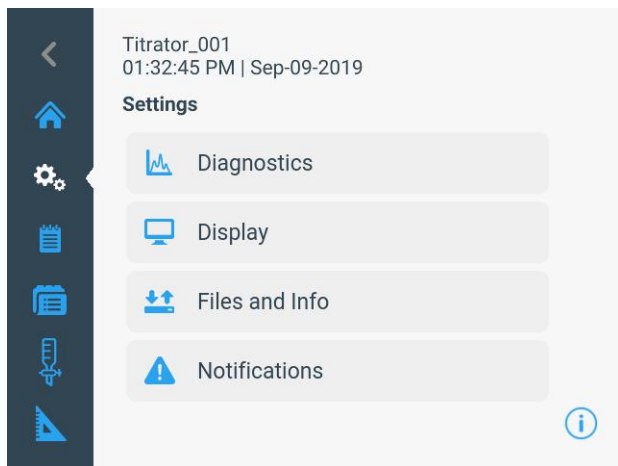

Diagnostics

Press the “Diagnostics” button to access the factory reset option for the titrator. Performing a factory reset will erase all custom settings and logs and return the titrator to the default general settings.

Display

Press the “Display” button to access settings for the display brightness, instrument name, date value and date format, time value and time format, language, temperature input and temperature units.

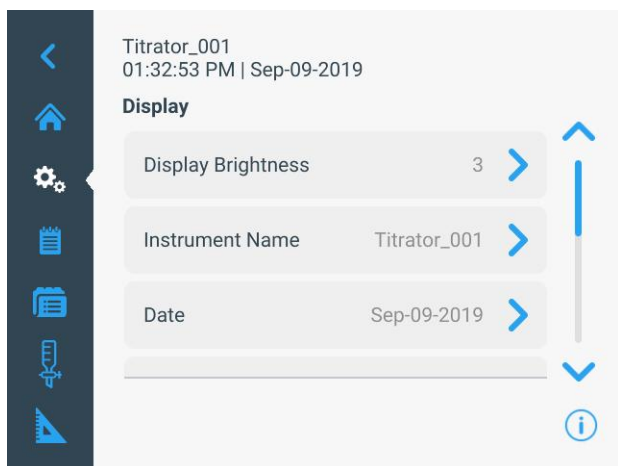

Temperature Input

Press the “Temperature Input” button to manually input the

sample temperature or perform a one-point temperature adjustment when using an ATC temperature probe.

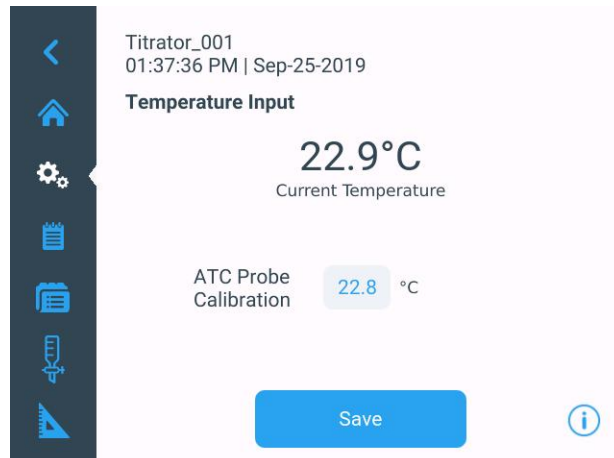

Files and Info

Press the “Files and Info” button to view the serial number, model number and firmware revision for the titrator and to perform an update on the titrator firmware.

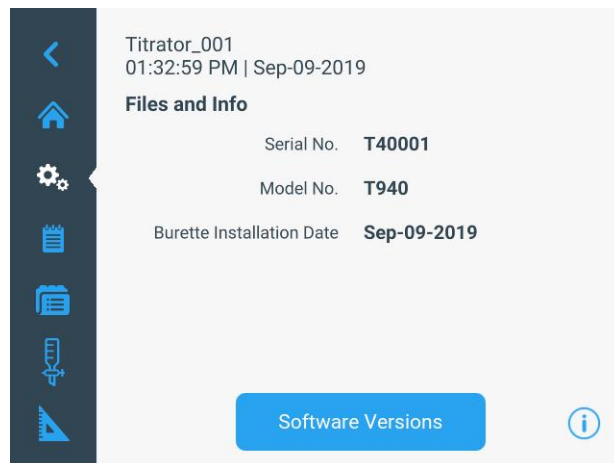

Notifications

Press the “Notifications” button to access the Titration Cycle Complete, Maximum Titrant Volume, Data Log Full, Calibration Due and Maintenance Due settings. Each setting can be turned off or on. When a notification is on, an audible beep is transmitted, with a popup warning as needed, when the appropriate conditions are met.

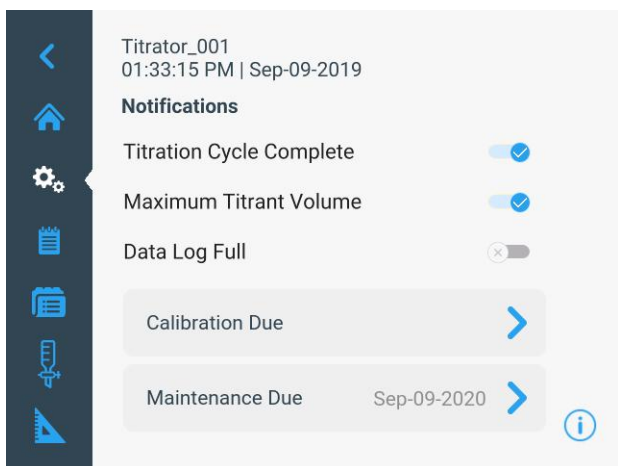

- Titration Cycle Complete – Audible beep when the titration cycle is done
- Maximum Titrant Volume – Audible beep when the titration maximum volume is reached
- Data Log Full – Audible beep and warning popup when any of the available data logs (Titration, Titrant, Calibration and Direct Measure) are within 5% of being full
- Calibration due – Audible beep and warning popup when the entered number of hours has elapsed without a calibration being performed for the selected electrode type



- Maintenance Due - Audible beep and warning popup when the selected maintenance time interval of 1 month, 3 months, 6 months or 12 months has elapsed, designed as general reminder for changing items such as the tubing, valve, burette or electrode

Logs

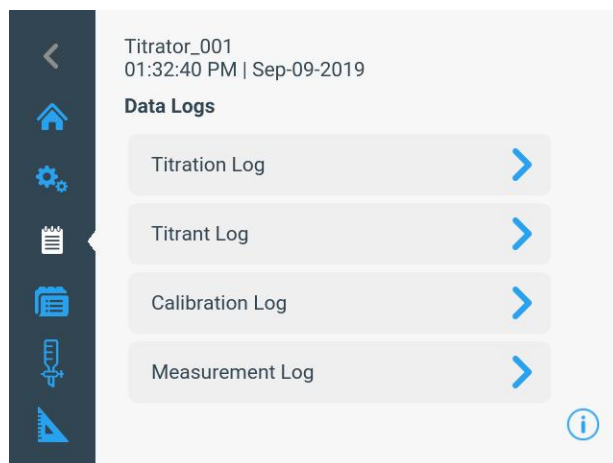

The Logs screen will display the active data logs: Titration Log, Titrant Log, Calibration Log and Direct Measure Log.

Each data log will save up to 100 data sets and once full, the oldest data set will be overwritten with the newest data set.

Exporting Data Logs

Data logs can be exported to a USB flash drive as a CSV or Report (PDF) file, exported to the Orion Star T900 series computer software or printed on the Orion compact printer (Cat. No. STARA-106) in short or long format.

The following is an example titration report file:

thermo scientific		Orion Star T940 All-in-One	
Report: Titration Results			
Instrument Name	Titrator_001		
Date & Time	Sep-04-2019 01:23 PM		
Method Name	HouseNH3_ab		
Sample ID	NH3_003		
Titrant Name	Vinegar		
Calibration Log Number	1		
Calibration Date & Time	Sep-04-2019 01:00 PM		
Average Slope Value	100.0 %		
Titrant Concentration	0.8330 M		
Titrant Input Date & Time	Sep-04-2019 01:08 PM		
Titration Technique	Equivalence Pt.		
Titration Type	Direct Titration		
Blank Required	No		
Reaction Ratio	1.000		
Sample Amount	Variable Volume		
Titrant Pre-dose Volume (Titration)	4.000 mL		
Titrant Max Volume	20.000 mL		
Titration Process Control (Titration)	Quick		
Analysis Results:			
Cycle Number	1		
Excluded	No		

Sample Amount	3.000 mL
Sample Concentration (1)	2.835 M
End Point Volume (1)	10.208 mL
End Point Value (1)	7.998 pH
Initial pH	11.849
Temperature	24.5 C
Titration Duration (Minutes)	00:02:42
Cycle Number	2
Excluded	No
Sample Amount	3.000 mL
Sample Concentration (1)	2.743 M
End Point Volume (1)	9.880 mL
End Point Value (1)	8.044 pH
Initial pH	11.82
Temperature	24.4 C
Titration Duration (Minutes)	00:02:53
Cycle Number	3
Excluded	No
Sample Amount	3.000 mL
Sample Concentration (1)	2.913 M
End Point Volume (1)	10.489 mL
End Point Value (1)	7.844 pH
Initial pH	12.337
Temperature	24.3 C
Titration Duration (Minutes)	00:03:34

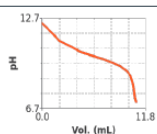
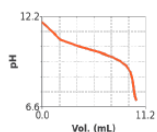
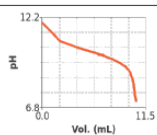

Result Summary	
Average Sample Concentration (1)	2.830 M
RSD (1)	2.99%
Temperature	24.4 C
Titration Duration (Minutes)	00:03:03

To view individual readings taken during the titration, export the data as a CSV file or export the data to the computer software and select the tabular data view.

Orion Star T900 Series Computer Software

The Orion Star T900 series computer software is designed to work with Orion Star T910 pH, T920 redox, T930 ion and T940 all-in-one titrators. The computer software facilitates the transfer of method, titration, standardization, calibration and direct measure data from the titrator to a computer for data viewing, data backup and report generation.

System Requirements

- The titrator must have a compatible software revision installed to communicate with the computer software, check info posted with the software file.
- Microsoft® Windows® 7 and higher computer

operating systems are supported

- The computer should have the latest Windows updates installed
- The operator must have administrative computer access to use the computer software

Connecting the Titrator to a Computer

The titrator connects to a computer via a virtual Ethernet over USB connection.

1. Ensure the titrator has the latest software revision and then power on the titrator.
2. Using the computer cable included with the titrator, connect the type B (square) end of the USB cable to the USB B connector on the titrator. Then connect the type A (rectangular) end to any available USB type A connector on the computer.
3. Windows should automatically detect the titrator and install the required driver, which may take a few minutes when a titrator is connected for the first time. You do not need to manually download or install any drivers, as the required RNDIS driver is included with Windows operating systems.

Installing the Computer Software

1. Download the computer software at www.thermofisher.com/orionsoftware, save the file to any convenient location on the computer and unzip/extract the folder to the same location on the computer.
2. Double click the **setup.exe** file to launch the installer.
3. If anti-virus software is installed, it may not recognize the computer software. If any warnings appear, click to allow the files to install.
4. Follow the on-screen instructions to finish installing the computer software.
5. Once the software is installed, an **OrionStarT900** icon will appear on the computer desktop. Double click this icon to launch the computer software.
6. When launching the software for the first time, a message may be shown from the Windows firewall regarding what types of networks to allow. It is recommended that you select all network types before clicking "allow access". The RNDIS network over USB connection is considered a "public"

network by Microsoft and the computer software must be allowed to access public networks to function.

- a. If your company has 3rd party firewall software or other non-standard configuration, contact your IT department to make sure the connection is allowed. The software will not function if it cannot connect to the RNDIS network.

7. Restart the computer to ensure the Orion Star T900 series computer software is fully installed before opening the program.

Using the Computer Software

Note: The computer display size of text and other items on the screen must be set to the default percentage to properly view the computer software.

1. Double click the OrionStarT900 icon on the computer desktop to launch the computer software.

- a. When launching the software for the first time, a message may be shown from the Windows firewall regarding what types of networks to allow. It is recommended that you select all network types before clicking “allow access”. The RNDIS network over USB connection is considered a “public” network by Microsoft and the computer software must be allowed to access public networks to function.

- b. If your company has 3rd party firewall software or other non-standard configuration, contact your IT department to make sure the connection is allowed. The software will not function if it cannot connect to the RNDIS network.

2. Once you select your language, the software will open to the “home” screen. The home screen shows a list of all titrators it has previously connected to, along with their serial number, instrument name and connection status.

- a. It may take a few moments for newly connected titrators to be visible on the network. Wait a few moments and then press the “Refresh” icon.

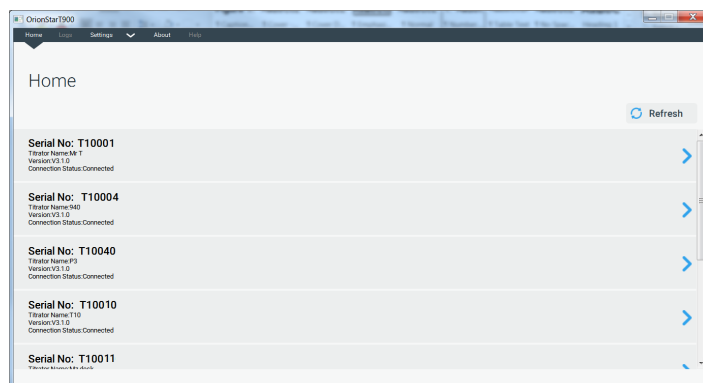

3. Click on the desired titrator to access its Logs screen.
4. Click the “Import” button to download the selected titrator’s data as a history file. Once a history file has been downloaded, you can view it again at any time without connecting to the titrator.
 - a. Press the “Import” button again to download a new history file when updated data is available on the titrator.

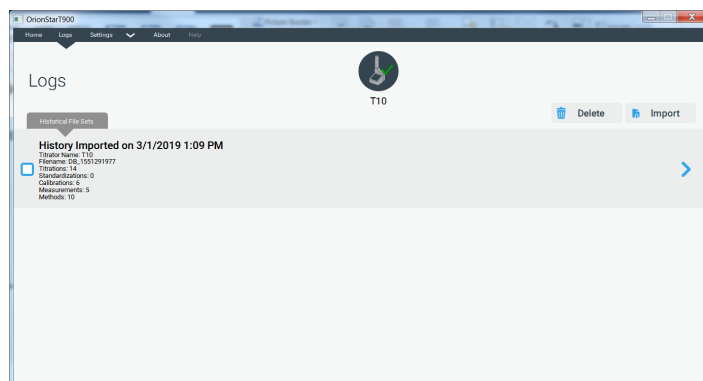

5. Click on a history file to open it and browse the titrator data. You can return to the home screen at any time by clicking “Home” in the upper navigation bar.

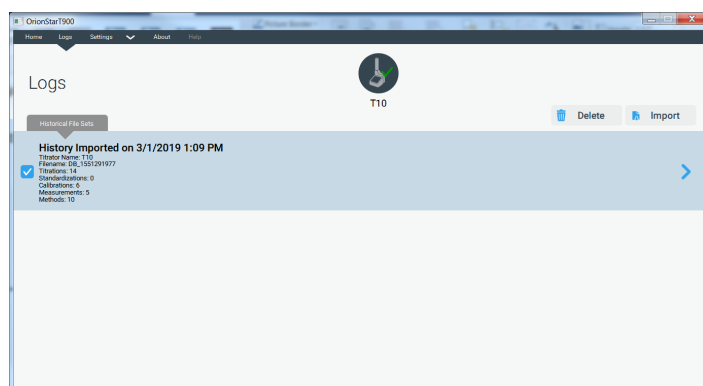

6. Click the Titration tab to view the titration data. Expand the summary line to view the individual cycle

data. Click on an individual cycle data line to view its data, graph results and setup parameters.

- a. Scroll right to view all data associated with the individual cycle data lines.

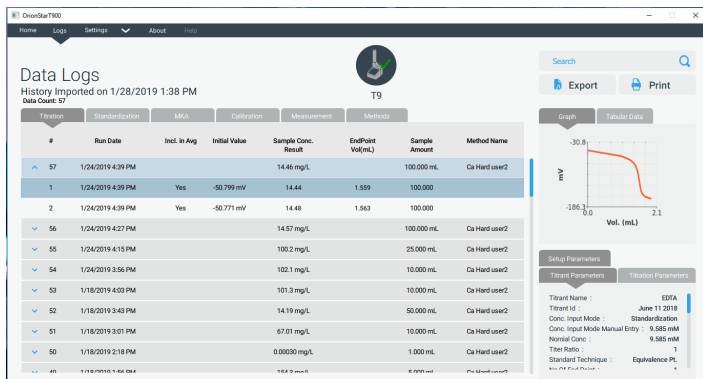

7. Click the Standardization tab to view the titrant standardization data. Expand the summary line to view the individual cycle data. Click on an individual cycle data line to view its data, graph results and setup parameters.

- a. Scroll right to view all data associated with the individual cycle data lines.

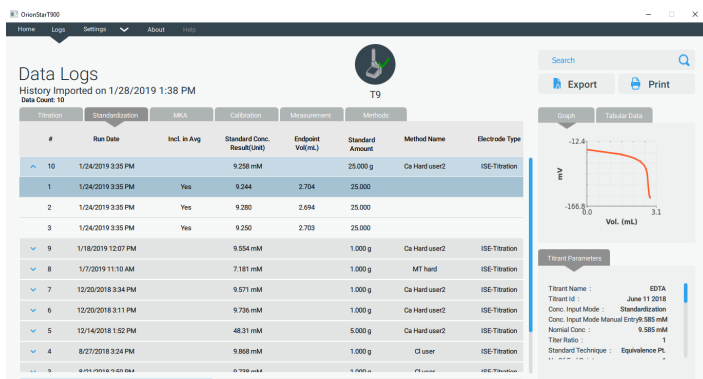

8. Click the MKA tab to view the multiple known addition data. Expand the summary line to view the individual cycle data. Click on an individual cycle data line to view its data, tabular results and setup parameters.

- a. Scroll right to view all data associated with the individual cycle data lines.

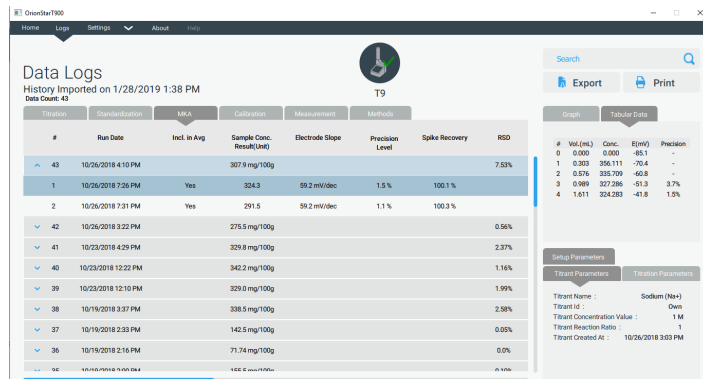

9. Click the Calibration tab to view the calibration data. Expand the summary line to view the individual calibration point data.

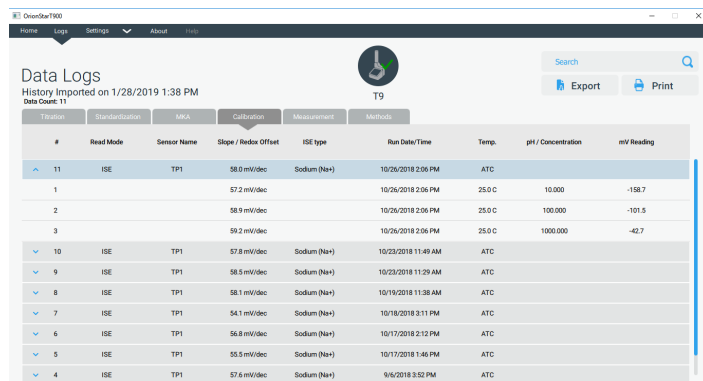

10. Click the Measurement tab to view the direct measure data. Scroll right to view all data associated with the direct measure data lines.

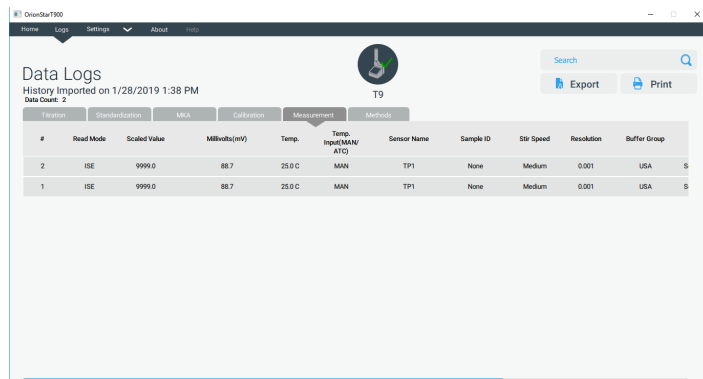

11. Click the Methods tab to view the methods data. Click on an individual method line to view its electrode, titrant and titration setup parameters data.

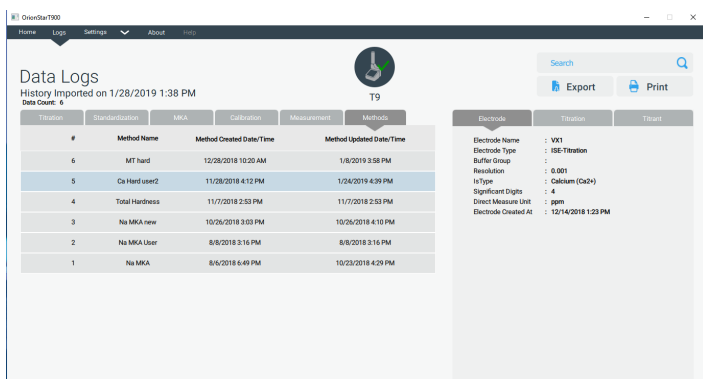

12. Click the “Export” button to save the data to your computer as a PDF or CSV file.
13. Click the “Print” button to print the data to your default network printer.

Methods

The Methods screen will display a list of all available methods followed by the “Create a New Method” button

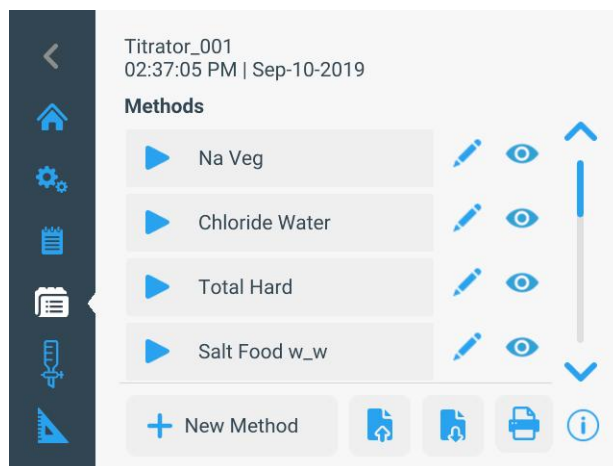

A total of ten unique methods may be saved, edited, imported or exported.

When a saved method is password protected, a Lock icon will be shown in addition to the Edit icon to the right of the method name

- Press an existing method to directly proceed to the Pre-Check screen of the titration using the selected method
- Press the "Edit" icon to the right of a saved method name to edit the method including Edit Name and Password, Edit Electrode, Edit Titrant, Edit Titration, Copy Method and Delete Method
 - To delete one or more methods from the methods list at the same time, swipe left on the method name to mark it for deletion
- Press the “View” icon to view a popup Quick View window with a summary of key method information
- Press the "+ New Method" button to create a new method. See the [Titration Setup Wizard](#) section for detailed instructions on how to setup the titrator to run a sample titration.
- Press the “Import” icon to import existing methods from a USB flash drive to the titrator
- Press the “Export” icon to export existing methods from the titrator to a USB flash drive – exported methods can be saved as a backup or imported onto another titrator

- Press the "Print" icon to print a summary of the existing methods on the titrator

Using Preprogrammed Methods

To download preprogrammed methods from the www.thermofisher.com/titrator website and load the methods onto the titrator, use the following procedure.

Note: If one or more methods are exported to a USB flash drive from the titrator, the titrator will automatically format the USB flash drive with the correct file folders and steps 1 and 2 can be skipped.

1. Create a folder named "OrionStar" on the root directory of a USB flash drive (not within a subfolder).
2. Create a folder named "methods_backup" within the "OrionStar" folder on the USB flash drive.
3. Download the preprogrammed methods file from the www.thermofisher.com/titrator website.
4. If the method files are in a compressed/ziped format (.zip), extract/unzip the files.
5. Save the method files to the "methods_backup" folder on the USB flash drive.
6. Connect the USB flash drive to the titrator and the titrator will show a popup message prompting to select and import the method files.

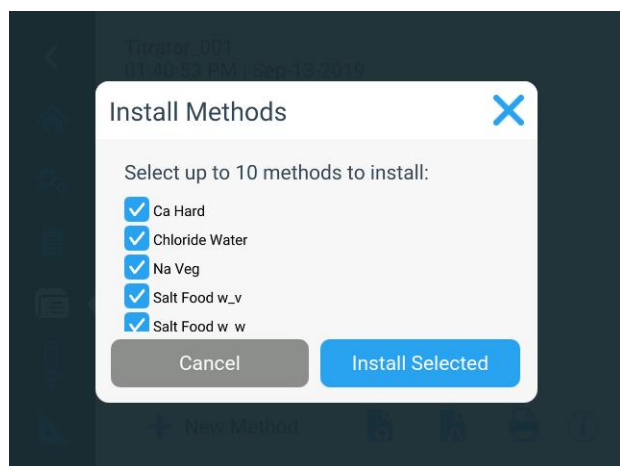

Burette

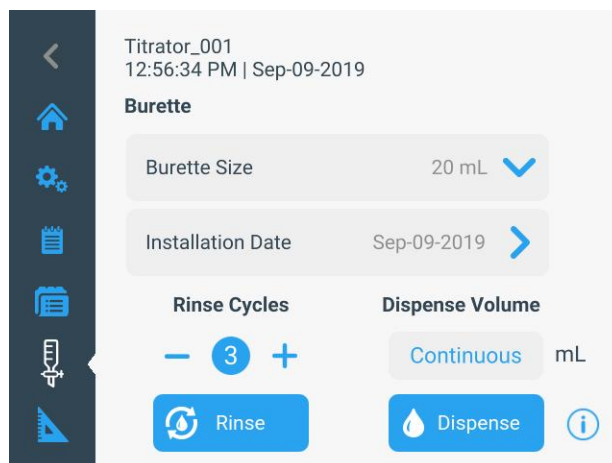

The Burette screen will display burette setup and maintenance items.

- Burette Size: Tap to select the burette size from the dropdown list of 10mL, 20mL or 50mL
- Installation Data: Tap to enter the installation data of the burette, designed as general reminder for changing the burette
- Rinse Cycles: Press the decrease (-) or increase (+) icons to change the number of rinse cycles for the burette and then press the "Rinse" button to start the rinse cycles.

Note: Place a waste beaker under the dispenser probe before starting the rinse cycles!

- Dispense Volume: Tap the field below Dispense Volume to select "Continuous" or "Preset Value".
 - For the Continuous setting, press and hold the "Dispense" button to manually flush a desired amount of solution through the burette
 - For the Preset Value setting, enter a volume of solution and then press the "Dispense" button to dispense the set volume through the burette

See the [Titrant Preparation](#) section for instructions on how to prepare the titrator with the titrant.

Note: Update the titrator software to version V3.2.0 or higher and the burette will allow refilling during titrations so titrant volumes greater than the burette volume can be used during the analysis.

Direct Measure



The Direct Measure screen will display a live electrode reading, helpful for checking sample measurements before performing a titration.

- Press the "Electrode" icon to edit the electrode parameters for the direct measure screen only
 - For the Orion T940 all-in-one titrator, use the "Electrode" icon to change the measurement mode for the direct measure screen to pH, mV or ion concentration
- Press the "Calibrate" icon to start a calibration for the direct measure screen only
- Press the "Save" icon save the displayed reading to the direct measure log
- Press the "Stirrer" icon to set the stirrer probe speed

pH Calibration for Direct Measure Mode

Note: Calibrations performed in the direct measure mode are separate from calibrations performed for titration methods. If you need to perform a calibration for a titration, for example a pH electrode calibration before performing a preset endpoint titration, start the calibration from the Methods menu, not the direct measure screen.

Always use fresh pH buffers and select buffers that are one to three pH units apart and bracket the expected sample pH.

1. In the Direct Measure screen and pH mode, press the "Calibrate" icon to start the calibration.
2. Rinse the pH electrode with distilled water, blot gently with a lint-free tissue to remove excess water and place into the pH buffer.

3. When the electrode and buffer are ready, press the "Start" button.
 - a. When using a stirrer probe, the probe will start stirring when "Start" is pressed and stop stirring when the reading is stable.
4. Wait for the pH value to stabilize, indicated by the green check icon, and perform one of the following actions:
 - a. Press the "Accept" button to accept the pH buffer value determined by the automatic buffer recognition function.

or

- b. Press the "Edit" button to access the popup numeric entry screen, manually enter the pH buffer value at its measured temperature, press the "Save" button and then press the "Accept" button.
5. Once the "Accept" button is pressed, the titrator will confirm that the calibration point was saved successfully.
 6. Press the "Next" button to proceed to the next pH buffer and repeat steps 3-5 or press the "Done" button to save and end the calibration.
 - a. When performing a one point calibration, the titrator will display a field where the slope can be entered. Use the numeric entry screen to enter the slope value and then press the "Save" button.
 7. The titrator will display the calibration summary including the average and segmented slope values. Press the "Done" button to return to the direct measure screen.

Redox Calibration for Direct Measure Mode

Note: Calibrations performed in the direct measure mode are separate from calibrations performed for titration methods. If you need to perform a calibration for a titration, for example a pH electrode calibration before performing a preset endpoint titration, start the calibration from the Methods menu, not the direct measure screen.

One standard can be used for a relative mV calibration. Always use fresh standard for calibration.

1. In the Direct Measure screen and mV mode, press the "Calibrate" icon to start the calibration.

2. Rinse the redox electrode with distilled water, blot gently with a lint-free tissue to remove excess water and place into the standard.
3. When the electrode and standard are ready, press the “Start” button.
 - a. When using a stirrer probe, the probe will start stirring when “Start” is pressed and stop stirring when the reading is stable.
4. Wait for the mV value to stabilize, indicated by the green check icon, and perform one of the following actions:
 - a. Press the “Accept” button to accept the displayed mV value for the standard.

or

- b. Press the “Edit” button to access the popup numeric entry screen, manually enter the mV value of the standard, press the “Save” button and then press the “Accept” button.
5. The titrator will confirm that the calibration point was saved successfully. Press the “Done” button to save and end the calibration.
6. The titrator will display the calibration summary including the entered, raw and offset mV values. Press the “Done” button to return to the direct measure screen.

1. In the Direct Measure screen and ISE mode, press the “Calibrate” icon to start the calibration.
2. Rinse the ion selective electrode with distilled water or rinse solution specified in the electrode manual, blot gently with a lint-free tissue to remove excess water and place into the standard.
3. When the electrode and standard are ready, press the “Start” button.
 - a. When using a stirrer probe, the probe will start stirring when “Start” is pressed and stop stirring when the reading is stable.
4. Wait for the concentration value to stabilize, indicated by the green check icon, and perform one of the following actions:

or

- a. Press the “Accept” button to accept the displayed standard value.
 - b. Press the “Edit” button to access the popup numeric entry screen, manually enter the standard value, press the “Save” button and then press the “Accept” button.
5. Once the “Accept” button is pressed, the titrator will confirm that the calibration point was saved successfully.
6. Press the “Next” button to proceed to the next standard and repeat steps 3-5 or press the “Done” button to save and end the calibration.
 - a. When performing a one point calibration, the titrator will display a field where the slope can be entered. Use the numeric entry screen to enter the slope value and then press the “Save” button.
7. The titrator will display the calibration summary including the average and segmented slope values. Press the “Done” button to return to the direct measure screen.

Ion Selective Electrode (ISE) Calibration for Direct Measure Mode

Note: Calibrations performed in the direct measure mode are separate from calibrations performed for titration methods. If you need to perform a calibration for a titration, for example a pH electrode calibration before performing a preset endpoint titration, start the calibration from the Methods menu, not the direct measure screen.

If more than one standard is used for calibration, start with the lowest concentration standard and work up to the highest concentration standard last. Always use fresh standards. Select standards that bracket the sample concentration and are one decade (10 times) apart in concentration. To accurately prepare calibration standards from a stock solution, serial dilution is recommended using calibrated pipettes. If ISA will be added to samples, the same ISA must be added to all standards prior to calibration to ensure a consistent dilution factor.

Chapter 4

Titration Use and Maintenance

Titration Mode

There are several ways to start a sample titration on the titrator, use the way that works best for your workflow.

- Press the “Repeat Last Titration” button on the home screen to perform a titration using the last used set of electrode, titrant and titration setup parameters, which can be helpful when performing the same titration over and over again
- To run a different titration using a saved method, press the “Use a Saved Method” button on the home screen to access the list of saved methods and then tap the desired method from the list.
- To enter a new set of electrode, titrant and titration parameters to run a new titration, press the “Start a New Titration” button on the home screen. See the [Titration Setup Wizard](#) section for instructions.

Once you have selected the method to start a sample titration, use the following procedure:

1. Before starting the titration, the titrator will display the pre-check screen. Prepare the sample and place the sample beaker under the electrode holder with the sensing electrode(s), stirrer probe and dispenser probe all immersed in the sample.
 - a. It is recommended that the stirrer probe be slightly below the dispenser probe and the same height as the sensing electrode(s).

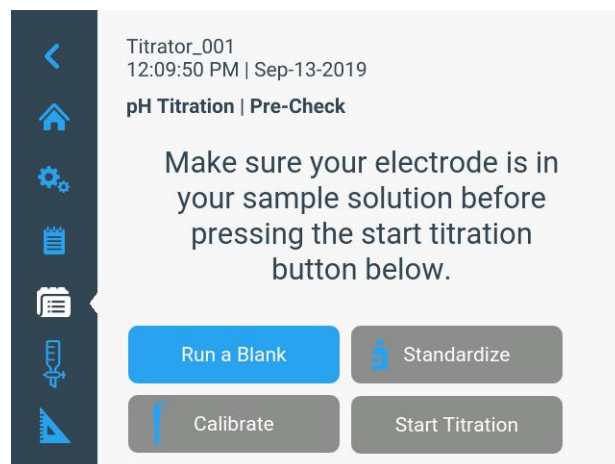

2. Press the “Start Titration” button.

Note: The titrator will immediately start dispensing titrant and taking readings, so the electrode, stirrer probe and dispenser probe must be in the sample beaker before pressing the “Start Titration” button.

- a. If manual sample entry is selected, a popup box will be displayed prompting you to enter the sample ID. Enter the ID using the alphanumeric keypad, press the “Save” button and then the titrator will start the titration.
- b. If variable weight or variable volume is selected for the sample amount, the titrator will display a popup box prompting you to enter the sample amount value. Enter the value using the numeric keypad, press the “Save-Run” button and then the titrator will start the titration.

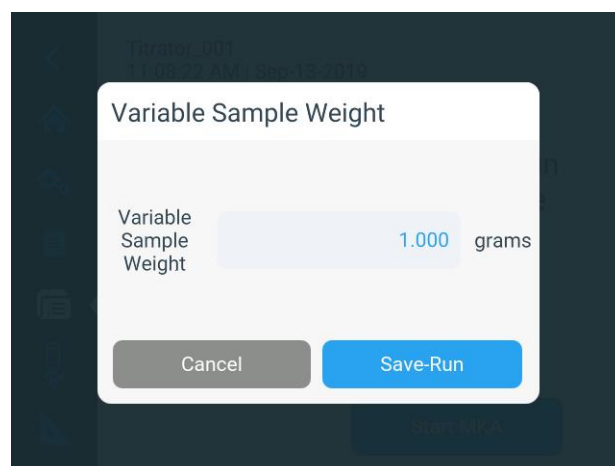

3. When the titration is started, the titrator will display the active measurements above the graph and the graph will update as the titration progresses.



Note: Press and hold the “Stirrer” icon at any time during the titration to adjust the stirrer probe speed.

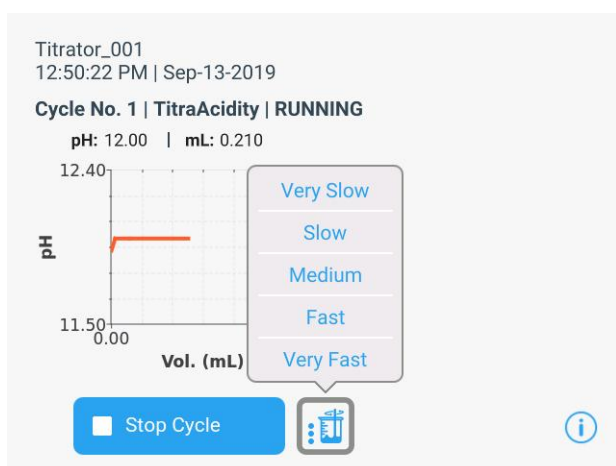

4. The titrator will continue to dispense titrant, take readings and analyze the data until it determines that the endpoint criteria have been met.



5. When the titration is complete, the titrator will display “STOPPED” and the calculated concentration and volume consumed during the titration will be shown on the right of the screen.

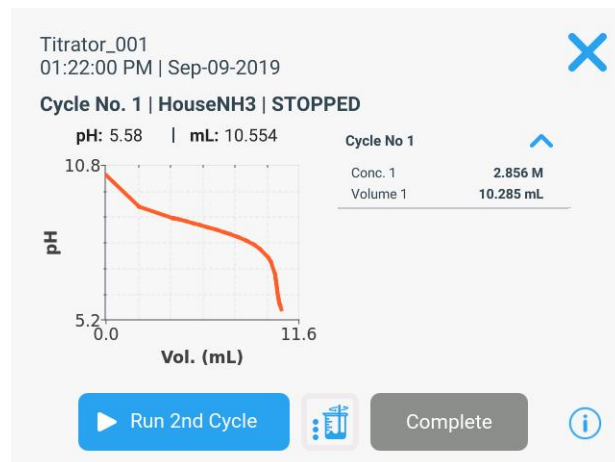

6. Press the “Run # Cycle” to perform another titration on a new aliquot of the same sample or press the “Complete” button to save and end the analysis.

Note: If the “Run # Cycle” button is selected, the titrator will immediately start dispensing titrant and taking readings, so the electrode, stirrer probe and dispenser probe must be in the next sample beaker before pressing this button.

- a. If the “Run # Cycle” button is selected, the titrator will repeat steps 3-5 on the next aliquot of sample.

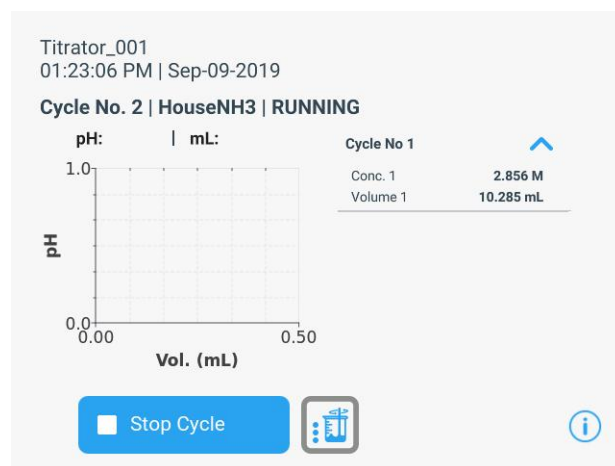

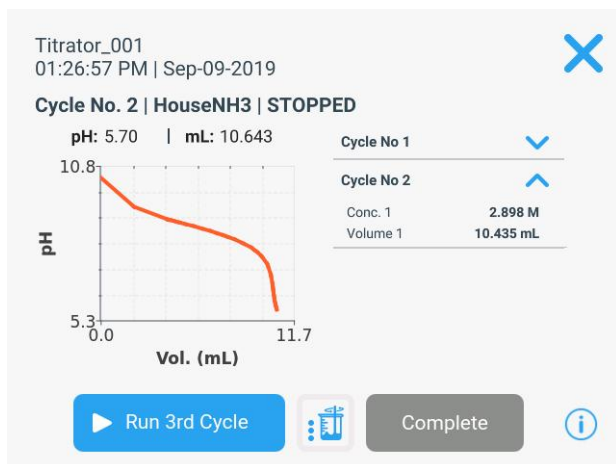

- b. Press the “Run # Cycle” to perform another titration on a new aliquot of the same sample or press the “Complete” button to save and end the analysis. The titrator can perform up to 5 cycles per sample.



7. Once the “Complete” button is pressed, the titrator will display the data summary screen. Scroll down to see the average concentration and RSD calculations.

- a. Individual cycles can be unchecked to be omitted from these calculations.

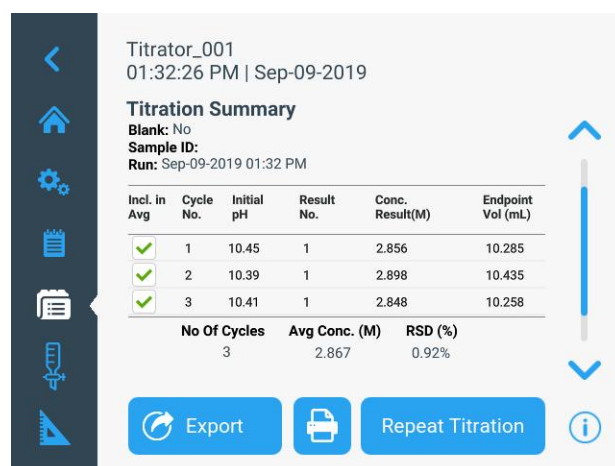
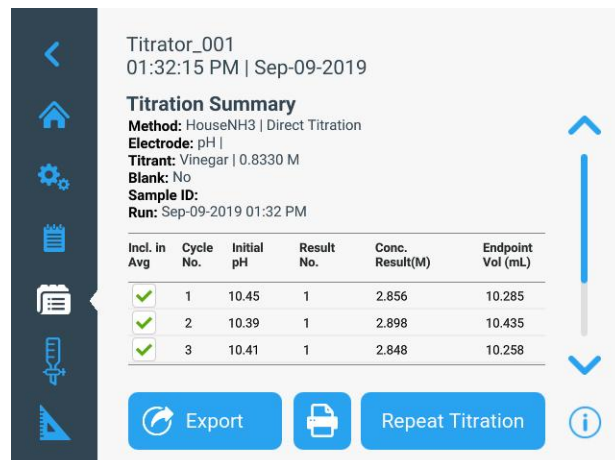

8. The titration data will be automatically saved to the titration data log.
- Press the “Export” button to export the titration data to a USB flash drive or press the “Print” icon to print the titration data to the compact printer, Cat. No. STARA-106.
 - Press the “Repeat Titration” button to go to the pre-check screen and use the same set of electrode, titrant and titration setup parameters to run a new sample titration.
 - Press the “Home” icon to return to the main titrator home screen.

Note: Update the titrator software to version V3.2.0 or higher and the burette will allow refilling during titrations so titrant volumes greater than the burette volume can be used during the analysis.

Standardization Mode

Over time, standard titrant solutions age and can change concentration. For higher accuracy, determine the exact concentration by standardizing the titrant. It is common to standardize on a weekly basis, but other standardization frequencies may be suitable.

1. Access the titration pre-check screen.
 - a. Press the “Repeat Last Titration” button on the home screen to perform a titration using the last used set of electrode, titrant and titration setup parameters
 - b. To run a different titration using a saved method, press the “Use a Saved Method” button on the home screen to access the list of saved methods and then tap the desired method from the list.
2. Before starting the standardization, the titrator will display the pre-check screen. Prepare the standard and place the standard beaker under the electrode holder with the sensing electrode(s), stirrer probe and dispenser probe all immersed in the sample.
 - a. It is recommended that the stirrer probe be slightly below the dispenser probe and the same height as the sensing electrode(s).

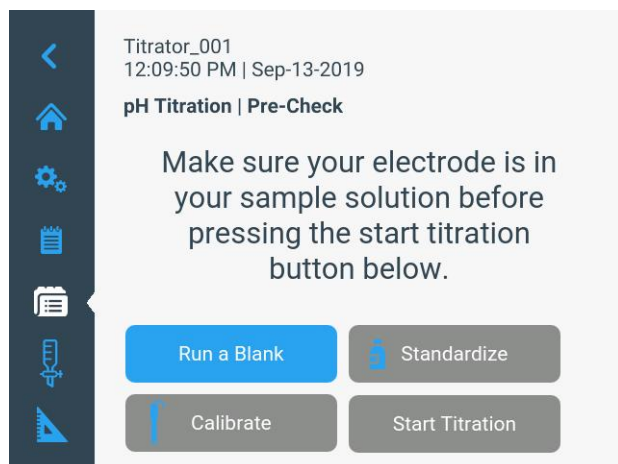

3. Press the “Standardize” button.

Note: The titrator will immediately start dispensing titrant and taking readings, so the electrode, stirrer probe and dispenser probe must be in the sample beaker before pressing the “Standardize” button.

- a. If variable weight or variable volume is selected for the standard amount, the

titrator will display a popup box prompting you to enter the standard amount value. Enter the value using the numeric keypad, press the “Save-Run” button and then the titrator will start the standardization.

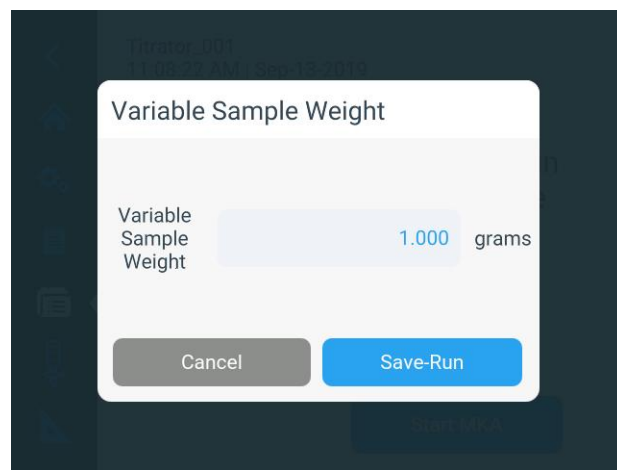

4. When the standardization is started, the titrator will display the active measurements as they are taken above the graph and the graph will update as the titration progresses.

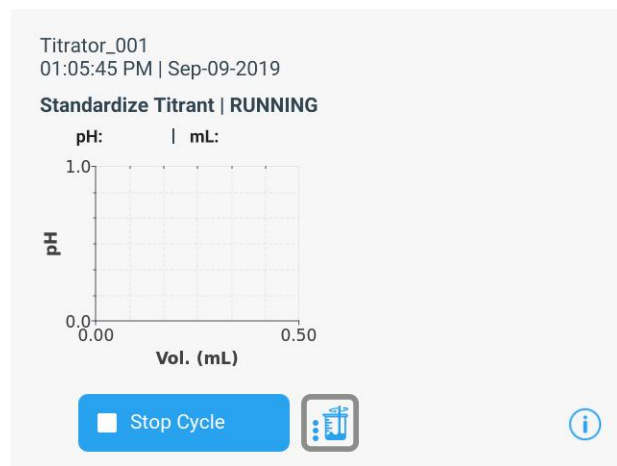

Note: Press and hold the “Stirrer” icon at any time during the titration to adjust the stirrer probe speed.

5. The titrator will continue to dispense titrant, take readings and analyze the data until it determines that the endpoint criteria have been met.



6. When the standardization is complete, the titrator will display “STOPPED” and the calculated concentration and volume consumed during the standardization will be shown on the right of the screen.

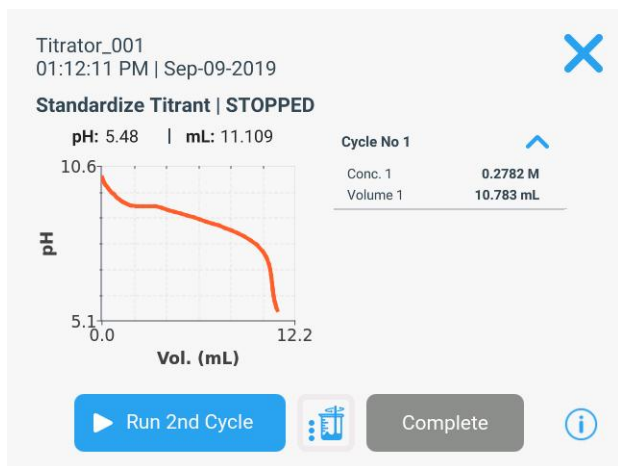

7. Press the “Run # Cycle” to perform another standardization on a new aliquot of the same standard or press the “Complete” button to save and end the analysis.

Note: If the “Run # Cycle” button is selected, the titrator will immediately start dispensing titrant and taking readings, so the electrode, stirrer probe and dispenser probe must be in the next standard beaker before pressing this button.

- a. If the “Run # Cycle” button is selected, the titrator will repeat steps 4-6 on the next aliquot of standard.
- b. Press the “Run # Cycle” to perform another standardization on a new aliquot of the same standard or press the “Complete” button to save and end the analysis. The titrator can perform up to 5 cycles per

standard.

8. Once the “Complete” button is pressed, the titrator will display the data summary screen. Scroll down to see the average concentration and RSD calculations. Individual cycles can be unchecked to be omitted from these calculations.

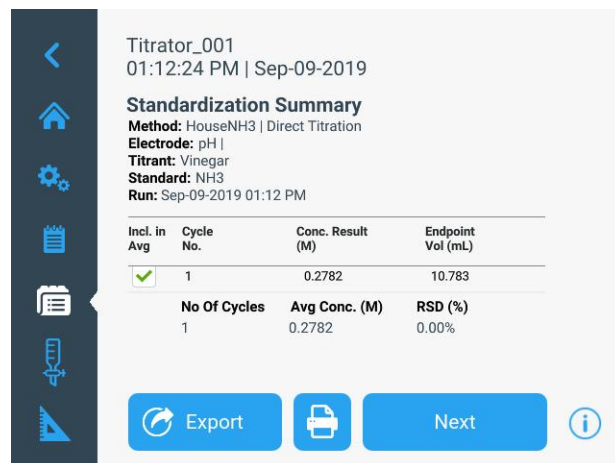

9. The standardization data will be automatically saved to the standardization data log.
 - a. Press the “Export” button to export the standardization data to a USB flash drive or press the "Print" icon to print the data to the compact printer, Cat. No. STARA-106.
 - b. Press the “Next” button to go to the pre-check screen and run a sample titration.

Calibrate Mode

It is strongly recommended to perform a pH calibration prior to performing a preset pH endpoint titration and helpful to perform a pH calibration prior to performing an equivalence point pH titration when the tabular data will be reported.

Always use fresh pH buffers and select buffers that bracket the expected pH range of the titration and are one to three pH units apart.

1. Access the titration pre-check screen.
 - a. Press the “Repeat Last Titration” button on the home screen to perform a titration using the last used set of electrode, titrant and titration setup parameters
 - b. To run a different titration using a saved method, press the “Use a Saved Method” button on the home screen to access the list of saved methods and then tap the desired method from the list.

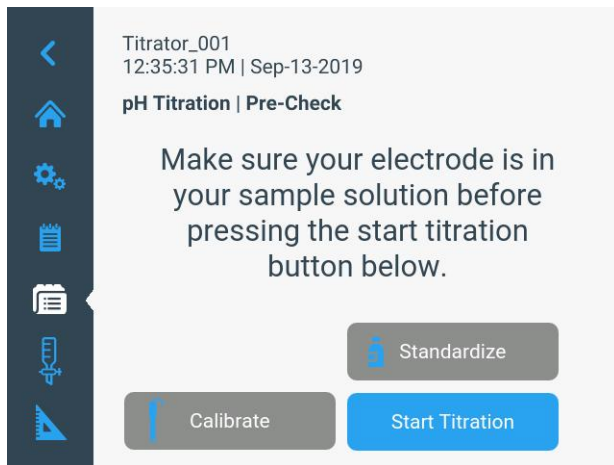

2. Press the “Calibrate” button.

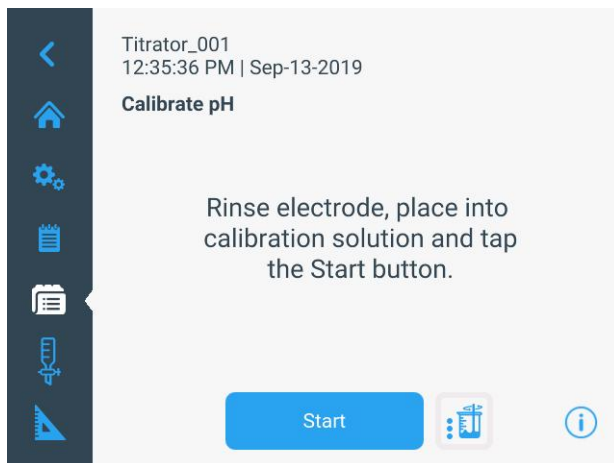

3. Rinse the pH electrode with distilled water, blot gently with a lint-free tissue to remove excess water and place into the pH buffer. When the electrode and buffer are ready, press the “Start” button.
 - a. If using a stirrer probe, the stirrer probe will start stirring when the “Start” button is pressed and stop stirring when the reading stabilizes.

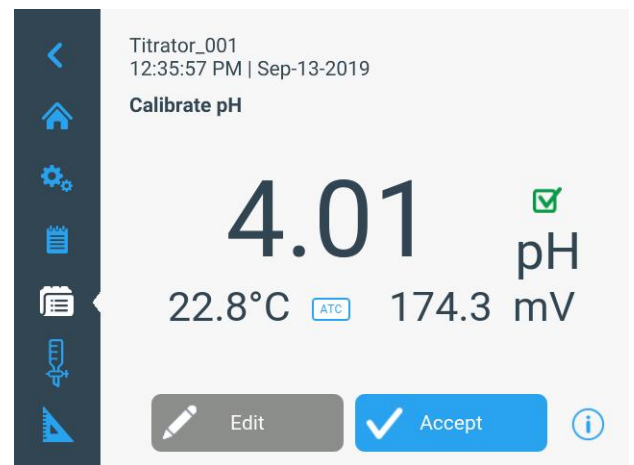

4. Wait for the pH value to stabilize, indicated by the green check icon, and perform one of the following actions:
 - a. Press the “Accept” button to accept the pH buffer value determined by the automatic buffer recognition function.
 - b. Press the “Edit” button to access the popup numeric entry screen, manually enter the pH buffer value at its measured temperature, press the “Save” button and then press the “Accept” button.

or

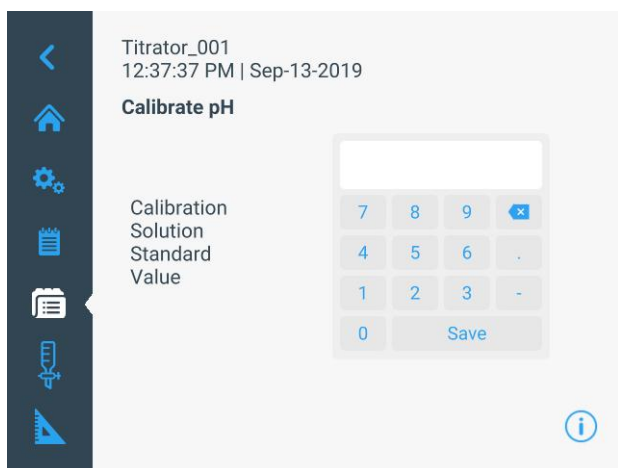
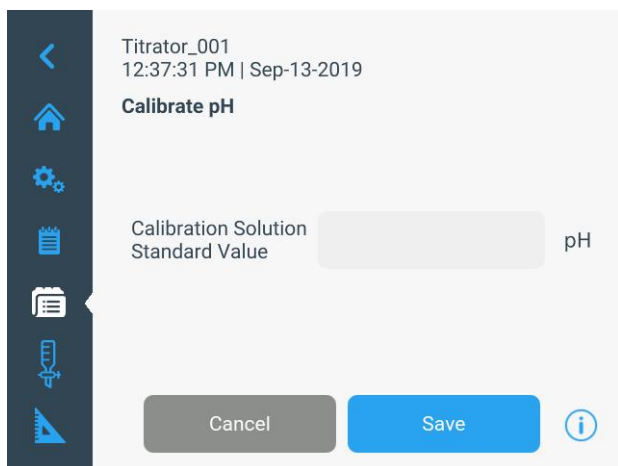

5. Once the “Accept” button is pressed, the titrator will confirm that the calibration point was saved successfully.

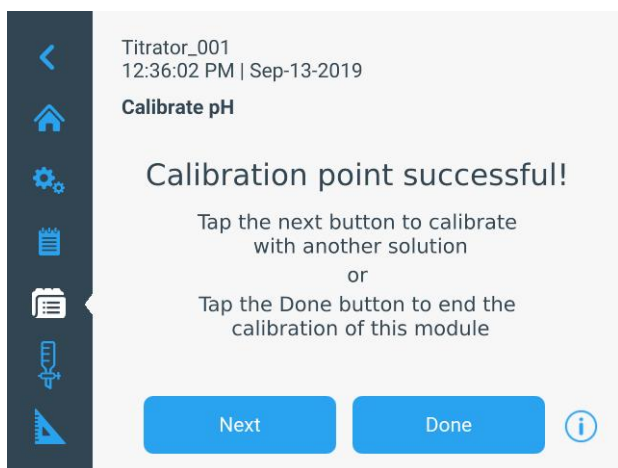

6. Press the “Next” button to proceed to the next pH buffer and repeat steps 3-5 or press the “Done” button to save and end the calibration.
 - a. When performing a one point calibration, the titrator will display a field where the slope can be entered. Use the numeric entry

screen to enter the slope value and then press the “Save” button.

7. The titrator will display the calibration summary including the average and segmented slope values.
 - a. Press the “Export” button to export the calibration data to a USB flash drive or press the "Print" icon to print the data to the compact printer, Cat. No. STARA-106.
 - b. Press the “Done” button to go to the pre-check screen and perform a titrant standardization or sample titration.

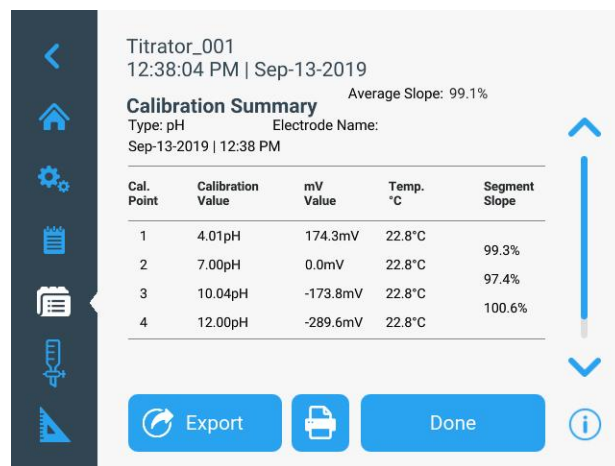

MKA Mode

Multiple known addition (MKA) is a technique of adding small, known amounts of a standard solution containing the ion or compound of interest to a sample and determining the sample concentration from the observed changes in potential after each dose addition. An ion selective electrode (ISE) is used to sense the potential changes due to concentration changes and the titrator calculates the amount of the ion or compound of interest in the sample. MKA can be used to enhance measurements normally performed by direct calibration and measurement. This technique can provide faster results more conveniently than traditional direct measurements and also helps to minimize matrix effects and offers greater precision than direct measurements.

In multiple known addition, three or more additions are made to the sample, allowing electrode slope, E_0 offset, sample concentration and a spike recovery to be calculated. This is a very precise technique because the calibration is performed directly in the sample matrix during analysis and there is no need for independent calibration (and periodic recalibration).

The Orion T900 series titrator automates the addition of small, known amounts of standard until the results calculated after each addition agree within the precision level selected by the method and each sample analysis is automatically verified by a spike recovery analysis.

1. Access the titration pre-check screen.
 - a. Press the “Repeat Last Titration” button on the home screen to perform a titration using the last used set of electrode, titrant and titration setup parameters
 - b. To run a different titration using a saved method, press the “Use a Saved Method” button on the home screen to access the list of saved methods and then tap the desired method from the list.

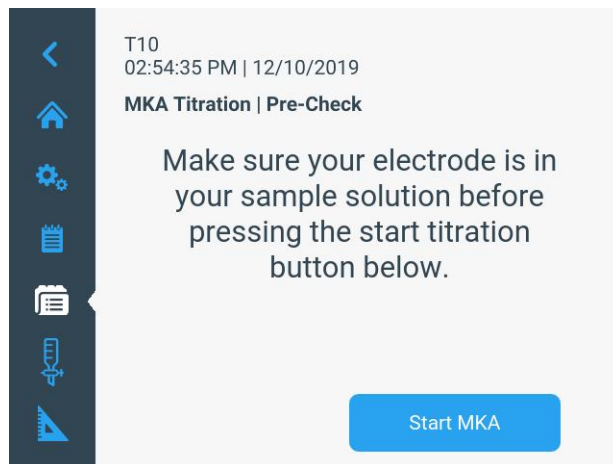

2. Prepare the sample and place the sample beaker under the electrode holder with the sensing electrode(s), stirrer probe and dispenser probe all immersed in the sample.
 - a. It is recommended that the stirrer probe be slightly below the dispenser probe and the same height as the sensing electrode(s).
3. Press the “Start MKA” button.

Note: *The titrator will immediately start dispensing titrant and taking readings, so the electrode, stirrer probe and dispenser probe must be in the sample beaker before pressing the “Start MKA” button.*

- a. If manual sample entry is selected, the titrator will display a popup box prompting you to enter the sample ID. Enter the ID using the alphanumeric keypad, press the “Save” button and then the titrator will start the MKA analysis.
- b. If variable weight is selected for the sample amount, the titrator will display a popup box prompting you to enter the sample amount value. Enter the value using the numeric keypad, press the “Save-Run” button and then the titrator will start the MKA analysis.

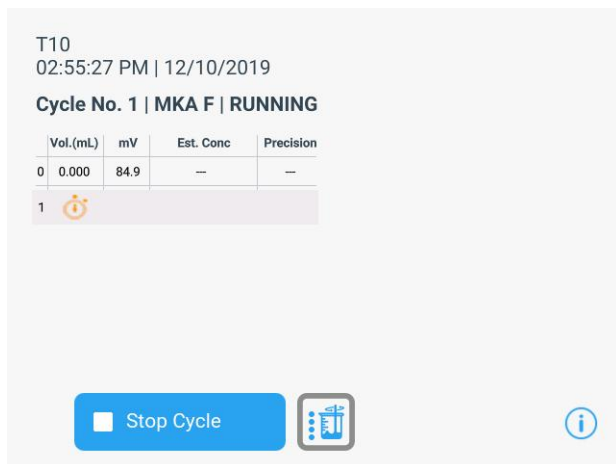

- When the MKA analysis is started, the titrator will display a wait icon until the added amount of standard is analyzed and the titrator determines that the MKA criteria has been met for that addition.

Note: Press and hold the “Stirrer” icon at any time during the titration to adjust the stirrer probe speed.

- The information shown in the table will update as the titrator makes more standard additions and analyzes the sample readings.

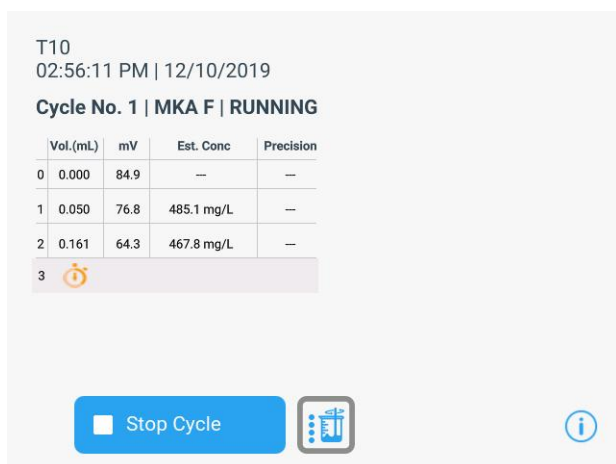

- When the MKA analysis is complete, the titrator will display “STOPPED” and the calculated concentration and slope value will be shown on the right of the screen.

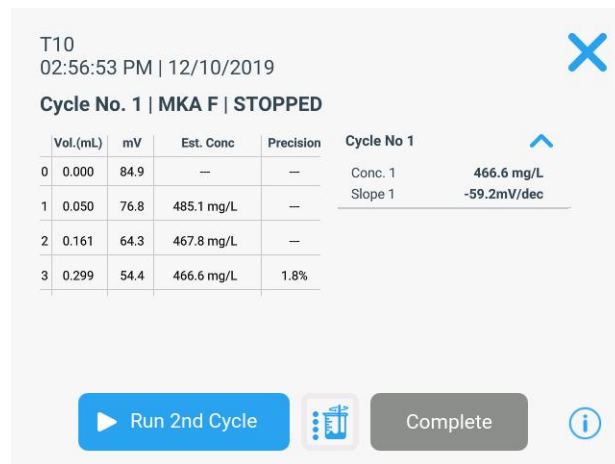

- Press the “Run # Cycle” to perform another MKA analysis on a new aliquot of the same sample or press the “Complete” button to save and end the analysis.

Note: If the “Run # Cycle” button is selected, the titrator will immediately start dispensing titrant and taking readings, so the electrode, stirrer probe and dispenser probe must be in the next sample beaker before pressing this button.

- If the “Run # Cycle” button is selected, the titrator will repeat steps 4-6 on the next aliquot of sample.
- Press the “Run # Cycle” to perform another MKA analysis on a new aliquot of the same sample or press the “Complete” button to save and end the analysis. The titrator can perform up to 5 cycles per sample.

- Once the “Complete” button is pressed, the titrator will display the data summary screen. Scroll down to see the average concentration and RSD calculations.

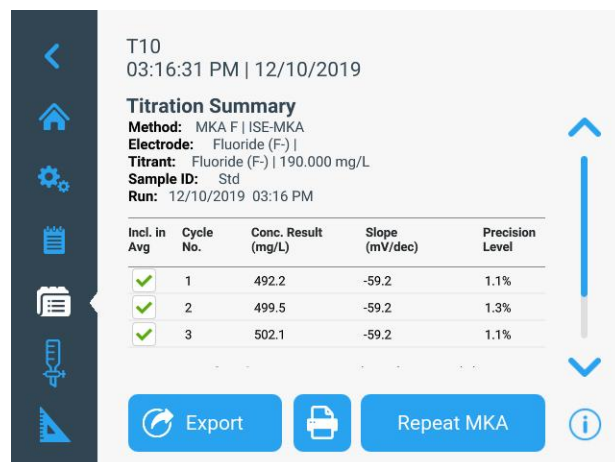

T10
03:16:23 PM | 12/10/2019

Titration Summary
Run: 12/10/2019 03:16 PM

Incl. in Avg	Cycle No.	Conc. Result (mg/L)	Slope (mV/dec)	Precision Level
✓	1	492.2	-59.2	1.1%
✓	2	499.5	-59.2	1.3%
✓	3	502.1	-59.2	1.1%

No Of Cycles	Avg Conc. (mg/L)	RSD (%)
3	497.9	1.03%

Export Print Repeat MKA

9. The MKA analysis data will be automatically saved to the titration data log.
 - a. Press the “Export” button to export the MKA analysis data to a USB flash drive or press the "Print" icon to print the data to the compact printer, Cat. No. STARA-106.
 - b. Press the “Repeat MKA” button to go to the pre-check screen and use the same set of electrode, titrant and titration setup parameters to run a new MKA analysis.
 - c. Press the “Home” icon to return to the main titrator home screen.

Maintenance Schedule

Help ensure the accuracy of your dispensing system by performing regular maintenance on your titrator.

- Conduct a thorough inspection of the titrator and perform any necessary maintenance every 3 months for normal operation.
 - For strong acids, strong bases or other aggressive titrants, increase the inspection and maintenance frequency as needed.
- Check for cleanliness and tight seal of the burette piston. Check whether moisture has penetrated below the piston. If any damage or leaking is noticed, replace the burette. Pay special attention to the edges of the glass and inspect for chips or other damage.
 - Burette should be replaced as needed, typically every 12 months.
- Check for cleanliness, connections and the seals of the tubing are securely fastened. Check for damage to the fittings and the tubing, including the tubing flare at the ends, which is required to be complete and uniform in order to maintain a seal.
 - Tubing should be replaced as needed, typically every 3 months.
- Check for cleanliness of the dispenser probe, especially at the tip. Make sure there is no particle blockage, no leaks at the tubing connections and no leaks at the dispenser tip. If damage or contamination is found, replace the component.
 - Dispenser probe should be replaced as needed, typically every 12 months.
- Check for visible damage or contamination of the electrical connections.
- Wipe off chemical spills immediately to avoid damage or discoloration of the titrator.
- The bottom and rear sides of the titrator must be kept dry. Liquid must not penetrate the interior of the instrument.
- The solenoid valve should last the life of the titrator; however, it may become clogged or damaged if proper maintenance is not performed on the titrator - in the event of failure, a valve replacement kit is

available using catalog number START- VK1.

- Store and maintain all electrodes per the manufacturer's instructions.

General pH Electrode Maintenance

Daily

- Rinse the electrode well and store every night in true pH electrode storage solution
- Remove the electrode from storage and rinse well with clean dionized water before use, between every measurement and after use
- Fill refillable electrodes up to the fill hole every day before use and make sure to open the fill hole during measurements and close the fill hole before storage

Biweekly

- Discard old pH electrode storage solution, wash out the storage bottle/container and fill it with fresh storage solution to prevent contamination and mold
- Drain and refill a refillable electrode with fresh fill solution and afterwards, soak the electrode overnight in storage solution

Monthly or As Needed

Clean the pH electrode when response is slow or calibration or verification does not meet criteria after corrective actions

- Use a general cleaner like Orion cleaning solution C, catalog number 900023, and follow the instructions
- Orion cleaning solution are also available for oil and grease, protein or bacteria

Dispense Verification Procedure

This procedure is recommended to verify the operation of the Orion Star T900 series titrator dispensing system. It is designed for operators to perform a check of the dispensing system in a laboratory environment for verification and troubleshooting purposes only. For certified validation of the dispensing system, which requires high-precision equipment in a controlled environment, please contact our technical support team at wlp.techsupport@thermofisher.com or your local Thermo Scientific Orion product distributor for titrator service options.

The Dispense Verification Kit (Cat. No. START-DVK) is an optional accessory for Orion Star T900 series titrators. The kit includes five plastic vials with caps, see an example below.

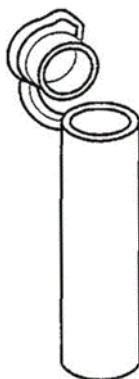

Note: To avoid fingerprints, wear clean, dry plastic gloves when handling the vials.

Note: Ensure that environmental conditions are between 15-30°C with less than 50% relative humidity.

1. Label the vials 1 through 5.
2. Record the ambient temperature and air pressure.
3. Rinse and fill the titrator dispensing system with deionized water.
 - a. Connect the filling tube to a bottle of deionized water
 - b. Place a large container (e.g., 500 mL beaker) under the dispensing probe.
 - c. Press the “Burette” icon to go to the Burette screen.
 - d. Press the “+” icon under Rinse Cycles to set

5 cycles.

- e. Press the “Rinse” button to start the rinse cycles.
 - f. At the completion of the rinse cycles, make sure the burette is fully filled with the deionized water and the tubing is fully filled and bubble-free.
4. Set the dispense volume for the verification test.
 - a. Press the button under Dispense Volume.
 - b. Select “Preset Value”.
 - c. Enter 5.00 mL using the numerical keypad and then press the “Save” button to return to the Burette screen.
 5. Weigh the empty vials and record the weights.
 - a. Ensure the vials are clean and dry.
 - b. Weigh each vial in grams using a calibrated analytical balance readable to 4 decimals (e.g. 0.0001 grams).
 - c. Record the weight values as $W_{\text{empty}\#1}$, $W_{\text{empty}\#2}$, $W_{\text{empty}\#3}$, $W_{\text{empty}\#4}$, and $W_{\text{empty}\#5}$.
 6. Press the “Dispense” button to dispense 5.00 mL water and discard the water. Make sure there is no water droplet suspended on the dispensing tip.
 7. Dispense 5.00 mL of deionized water into each vial.
 - a. Place the first weighed vial under the dispensing tip and press “Dispense” to dispense 5.00 mL of deionized water into the vial.

Note: Make sure there is no water droplet suspended on the dispensing tip and that all 5.00 mL has been collected into the vial.

- b. Cap the vial.
 - c. Repeat the process for all five vials.
8. Weigh the filled vials and record the weights.
 - a. Weigh each of the filled and capped vials using the same analytical balance used in Step 5.
 - b. Record the weight values as $W_{5\text{mL}\#1}$, $W_{5\text{mL}\#2}$, $W_{5\text{mL}\#3}$, $W_{5\text{mL}\#4}$, and $W_{5\text{mL}\#5}$.
 9. Calculate the amount of water collected in each vial:

$$\Delta W_i = (W_{5\text{mL}\#i}) - (W_{\text{empty}\#i})$$

Where i is the identification number of the vial, 1 - 5

10. Find the conversion factor Z value based on the recorded temperature and air pressure per the [Z Value Table](#) (Reference: ISO 8655-6:2002E). The Z value is for converting the weight of the pure water to volume at test temperature and air pressure. A typical value is 1.0032 mL/g at 22 °C and 95 kPa.
11. Calculate the volume values V_i , the average value of V_i , the Accuracy, the Standard Deviation (SD) and the Relative Standard Deviation (RSD).
 - a. $V_i = Z \times \Delta W_i$
 - b. $AverageV = \frac{\sum_{i=1}^5 V_i}{5}$
 - c. $Accuracy = \frac{AverageV - 5.00}{5.00} \times 100\%$
 - d. $SD = \sqrt{\frac{\sum_{i=1}^5 (V_i - AverageV)^2}{4}}$
 - e. $RSD = \frac{SD}{AverageV} \times 100\%$

Z Value Table

Z correction factors for distilled water as a function of temperature and air pressure

Z Values in mL/g or $\mu\text{L}/\text{mg}$

Temp	Air Pressure (kPa)						
°C	80	85	90	95	100	101.3	105
15.0	1.0017	1.0018	1.0019	1.0019	1.0020	1.0020	1.0020
15.5	1.0018	1.0019	1.0019	1.0020	1.0020	1.0020	1.0021
16.0	1.0019	1.0020	1.0020	1.0021	1.0021	1.0021	1.0022
16.5	1.0020	1.0020	1.0021	1.0021	1.0022	1.0022	1.0022
17.0	1.0021	1.0021	1.0022	1.0022	1.0023	1.0023	1.0023
17.5	1.0022	1.0022	1.0023	1.0023	1.0024	1.0024	1.0024
18.0	1.0022	1.0023	1.0023	1.0024	1.0025	1.0025	1.0025
18.5	1.0023	1.0024	1.0024	1.0025	1.0025	1.0026	1.0026
19.0	1.0024	1.0025	1.0025	1.0026	1.0026	1.0027	1.0027
19.5	1.0025	1.0026	1.0026	1.0027	1.0027	1.0028	1.0028
20.0	1.0026	1.0027	1.0027	1.0028	1.0028	1.0029	1.0029
20.5	1.0027	1.0028	1.0028	1.0029	1.0029	1.0030	1.0030
21.0	1.0028	1.0029	1.0029	1.0030	1.0031	1.0031	1.0031
21.5	1.0030	1.0030	1.0031	1.0031	1.0032	1.0032	1.0032
22.0	1.0031	1.0031	1.0032	1.0032	1.0033	1.0033	1.0033
22.5	1.0032	1.0032	1.0033	1.0033	1.0034	1.0034	1.0034

23.0	1.0033	1.0033	1.0034	1.0034	1.0035	1.0035	1.0036
23.5	1.0034	1.0035	1.0035	1.0036	1.0036	1.0036	1.0037
24.0	1.0035	1.0036	1.0036	1.0037	1.0037	1.0038	1.0038
24.5	1.0037	1.0037	1.0038	1.0038	1.0039	1.0039	1.0039
25.0	1.0038	1.0038	1.0039	1.0039	1.0040	1.0040	1.0040
25.5	1.0039	1.0040	1.0040	1.0041	1.0041	1.0041	1.0042
26.0	1.0040	1.0041	1.0041	1.0042	1.0042	1.0043	1.0043
26.5	1.0042	1.0042	1.0043	1.0043	1.0044	1.0044	1.0044
27.0	1.0043	1.0044	1.0044	1.0045	1.0045	1.0045	1.0046
27.5	1.0045	1.0045	1.0046	1.0046	1.0047	1.0047	1.0047
28.0	1.0046	1.0046	1.0047	1.0047	1.0048	1.0048	1.0048
28.5	1.0047	1.0048	1.0048	1.0049	1.0049	1.0050	1.0050
29.0	1.0049	1.0049	1.0050	1.0050	1.0051	1.0051	1.0051
29.5	1.0050	1.0051	1.0051	1.0052	1.0052	1.0052	1.0053
30.0	1.0052	1.0052	1.0053	1.0053	1.0054	1.0054	1.0054

Titrator and Burette Storage

For short and long term storage, the burette should be flushed with the following procedure and then all components should be rinsed with deionized water, dried thoroughly and stored in the original titrator box or similar secure packaging.

1. Disconnect the bottle tubing from the titrant bottle and leave the tubing disconnected and open to air.
 - a. Ensure the tubing is in a clean area, away from dirt or dust that may clog the tubing.
2. Perform 3 rinse cycles to remove the first titrant and flush the burette, tubing and dispenser with air.
3. Connect the bottle tubing to GL38 bottle cap and plastic bottle, or the preferred bottle, filled with deionized water.
4. Perform 3 rinse cycles to flush the burette, tubing and dispenser with deionized water.
5. Disconnect the bottle tubing from the titrant bottle and leave the tubing disconnected and open to air.
6. Perform 3 rinse cycles to flush the burette, tubing and dispenser with air.
7. Remove the burette from the titrator and in an appropriate location tip the burette upside down and gently shake as much of the remaining water out of the burette as possible.
8. The burette can be stored in the included protective storage box or similar secure packaging.
9. Disconnect all tubing and then rinse all components with deionized water, dry all components thoroughly and store all components in the original titrator box or similar secure packaging.

See the [Changing the Titrant](#) section for the recommended procedure for swapping titrants on the titrator.

Recommended Verification Criteria

- The recommended accuracy specification is $\pm 0.3\%$
- The recommended RSD specification is 0.1% or less

Actual dispense verification results will depend on environment conditions, equipment handling and balance accuracy.

This procedure is designed for operators to perform a check of their dispensing system in a laboratory environment for verification and troubleshooting purposes only.

For certified validation of the dispensing system, which requires high-precision equipment in a controlled environment, please contact the Thermo Scientific Orion technical support team or your local Thermo Scientific Orion product distributor for titrator service options.

Chapter 5

Customer Services

Troubleshooting

Troubleshooting Checklist

1. Inspect the titrator and all components for any obvious visual indicators of issues including:
 - a. Check that there are no bubbles in each of the tubing sections.
 - b. Check that all tubing is fully and properly connected to the correct ports.
 - c. Check that the titrant bottle is sufficiently full so that the titrant level is above the tubing inside the bottle.
 - d. Check that the burette is filled with titrant.
 - e. Check that all electrodes are fully and properly connected to the correct connections on the back of the titrator.
 - f. Check that the dispenser probe is operating correctly and that there is no buildup or clogging on the dispenser probe tip.
 - g. Check that the electrodes are clean with no cracks or buildup and if using a refillable sensing electrode, make sure the electrode fill solution level is at least one inch above the sample level and the fill hole is open during analysis.
2. Perform the general maintenance listed in the [Maintenance Schedule](#) section.
3. Perform maintain on all electrodes according to the manufacturer's instructions.
4. For issues that may be calculation related, review the electrode, titrant and titration setup parameters to ensure all settings are entered correctly.

5. For issues that may be software related, update the titrator to the latest software revision – see the [Updating Titrator Software](#) section for detailed instructions – and then perform a factory reset.
 - a. Before performing a factory reset on the titrator, backup and export all data log files to a USB flash drive or printer, as data log files will be deleted from the titrator when the reset is performed. It is also recommended to backup and export all saved methods to a USB flash drive.
 - b. From the home screen, press the “General Settings” icon and then press the “Diagnostics” button to access the factory reset option for the titrator.
 - c. Press the “Factory Reset” button and then the “Start” button.
 - d. Wait while the titrator is reset to factory default settings. Once complete, the titrator will launch the Instrument Setup Wizard.

Frequently Asked Questions

What is titration?

Titration is an analytical technique which allows the quantitative determination of a specific substance (analyte) dissolved in a sample. It is based on a complete chemical reaction between the analyte and a reagent (titrant) of known concentration which is added to the sample:

Analyte (Sample) + Titrant (Reagent) → Reaction Products

The titrant is added until the analyte is either neutralized or completely reacted. In order to be suitable for determination, the end of the titration reaction has to be observable. This means that the reaction has to be monitored (indicated) by appropriate techniques such as a sensor or by color change. The volume of the dispensed titrant is used in the calculation of the analyte concentration based on the stoichiometry of the chemical reaction. Titration reactions ideally are fast, complete, unambiguous and observable. A well-known example is the titration of acetic acid in vinegar with sodium hydroxide.

Which types of chemical reactions are used in titration?

Some more common titration reactions are:

- Acid/Base reactions, for example, total acidity of wine, juice, milk or ketchup
- Ion selective reactions, for example, chloride content in foods such as potato crisps/chips or ketchup
- Precipitation reactions, for example, salt content in foods such as potato crisps/chips or ketchup, sulfate content in mineral water, sulfate content in electroplating bath
- Redox reactions, for example, copper, chromium and nickel content in electroplating baths
- Complexometric reactions, for example, total hardness of water (magnesium and calcium), calcium content in milk, cheese and cement
- Colloidal precipitation reaction, for example, anionic surfactant content in detergents, washing powders or liquid cleanser

What is the difference between preset endpoint and equivalence point titration?

The equivalence point is the exact point in a titration when moles of titrant equal moles of analyte. The preset endpoint is the point where the system changes when the moles of the reacting titrant exceed the moles of the analyte.

Preset Endpoint Titration Mode (EP):

The preset endpoint is when the sample is titrated until a predefined mV or pH value is reached. A designated mV or pH value is chosen to represent this point, for example when the pH is 8.2. This predefined value is assumed to represent the point where the full reaction of the analyte with titrant is complete.

Equivalence Point Titration Mode (EQP):

The equivalence point, or stoichiometric point, of a chemical reaction is the point at which chemically equivalent quantities of titrant and analyte have been mixed. It is assumed to be where the inflection point of the titration curve occurs.

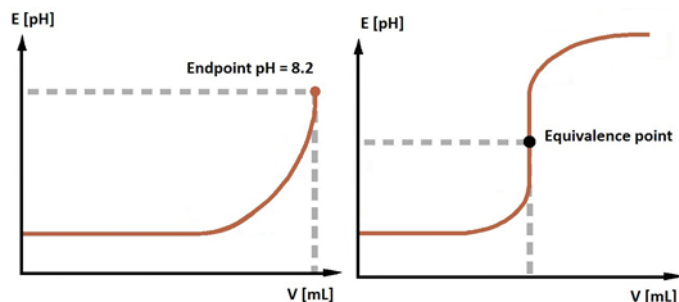

What are the common sensor indication methods

used in titration?

Titration can be classified according to the indication principles and the chemical reaction occurring:

Potentiometry

The concentration-dependent potential (mV) of a solution is measured against a reference potential. Examples: acid/base (aqueous/non-aqueous), ion selective electrode (ISE), redox, precipitation reactions. The Orion Star T900 series titrators are potentiometric titrators.

Voltammetry

The concentration-dependent potential of a solution (mV) is measured at a constant polarizing electric current. Example: Karl Fischer moisture/water determination.

Amperometry

The concentration-dependent electric current of a solution is measured at a constant applied potential. Examples: chlorine and chlorine dioxide amperometric titrations.

What is an automated titrator?

Automated titrators are microprocessor-controlled instruments which allow the automation of all operations involved in titration:

1. Calibration of electrode
2. Standardize the titrant
3. Titration setup
4. Titration run (cycle)
 - a. Titrant addition
 - b. Monitoring of the reaction (signal acquisition)
 - c. Recognition of the reaction progress
 - d. Results calculation
 - e. Data and results storage
 - f. Transfer of data to printer, computer or USB flash drive

How does an automated titrator work?

Automated titrators follow a defined sequence of operations. This sequence is basically the same for all point of the titration reaction is reached (titration cycle). The titration cycle consists mainly of 4 steps:

1. Titrant addition
2. Titration reaction

3. Signal acquisition

4. Evaluation

Each step has different specific parameters (i.e. increment size), which have to be defined according to the specific titration method. Additional steps are included when running complex applications. For example, pre-dose dispense reagent to adjust pH value to a starting point, dispense of an additional reagent for back titrations, and dilution of the sample. These steps and the corresponding parameters are defined in the titration method.

How can I find out what the software version is of my instrument?

At the home screen, press the "General Settings" icon. In the general settings screen, press the "Files and Info" button.

The serial number, model number and firmware revision for the titrator will be displayed.

How should my electrode be stored?

pH and redox electrodes should be stored in pH electrode storage solution or solution matching the electrode filling solution composition.

Ion selective electrodes should be stored according to instructions in the electrode manual, as each ion selective electrode has a specific storage solution recommended for best performance.

Stirrer probes and ATC temperature probes and can be stored dry.

Dispense probes can be stored in the same solution as the pH, redox or ion selective electrode and then rinsed in deionized water before use.

How often do I need to standardize my titrant?

This depends on the stability of the titrant and its storage conditions. Light sensitive titrants, like iodine, should be stored in light blocking bottles, for example amber glass bottles. Strong bases, like sodium hydroxide, should be protected from absorption of carbon dioxide. Commonly, titrants will be standardized once per week but the frequency should be determined by the individual lab requirements.

How often should I calibrate my electrode?

This depends on the samples that are being measured with the electrode, but as a general rule, pH electrodes should be calibrated at least once per day or eight hour shift.

Redox and ion selective electrodes do not need to be calibrated before performing a titration, but if the direct

measure mode will be used, the same once per day or eight hour shift is recommended.

Why is temperature compensation important in pH measurements?

When measuring the pH of a solution there are three main temperature influences that should be considered.

The first influence is that the slope of the pH electrode calibration curve given by the Nernst equation is temperature dependent. Provided the temperature of the buffers is taken into account during calibration, any difference between this temperature and that of the actual samples being measured can be mathematically compensated for with the active pH electrode calibration curve when using most current pH meters and titrators.

A second influence involves changes in the pH value of a sample with temperature changes. For example, a weak acid that only partly dissociates in solution – the higher the temperature of the solution, the greater will be the degree of dissociation of the acid, and therefore the lower the pH of the solution. This influence is completely sample dependent and cannot be compensated for by a pH meter or titrator. For this reason, all measured sample pH values should be reported with the specific sample temperature.

The third influence relates to the first and second but involves the pH electrode calibration with pH buffers. As pH buffers are often made up of acids and bases, their pH is also temperature dependent. In order for a pH meter or titrator to be calibrated correctly, it is necessary for the actual pH value at the measured temperature to be entered or automatically recognized by the meter or titrator during the calibration.

Why are my results half or double those expected?

There are two main possibilities.

Confirm the burette size has been correctly defined, for example, the titrator has been told that there is a 10 mL burette in use when in fact the burette in use is a 20 mL burette. In this case, the results will be roughly half of the expected results.

Confirm the reaction ratio, equivalent number or valency is correct. Make sure that you are titrating to the correct equivalence point.

Why is the result of my equivalence point titration different from my manual color titration?

This discrepancy in results is primarily noticeable when performing acid/base titrations using one of the pH color

indicators. The pH indicators change color over a pH range rather than at a fixed value. The actual point at which the color change occurs is very much sample dependent and may not coincide with the chemical equivalence point. This can result in a small discrepancy. Make sure to standardize the titrant.

The second reason for this difference is primarily one of the sensitivity of the human eye to color change. While a color change may have already started to occur, the human eye has still not detected any change. In the typical acid/base titration using potentiometric indication with a pH sensor, the sharp change in signal occurs at the first instance of excess acid (or base).

What electrode should I use for non-aqueous titrations?

Generally there are three main electrode problems when performing a non-aqueous titration.

The first is the problem of having an aqueous fill solution with a non-aqueous sample. Replacing the fill solution in the electrode with one that more closely matches the sample composition can solve this problem.

The second problem relates to the fact that the sample is non-conductive, resulting in a poor electrical circuit between the measuring sensor and reference half-cell. This results in a noisy signal, particularly when using a sensor with a standard ceramic junction in the reference.

The third problem is associated with handling of the pH electrode. In order for a glass (pH) sensor to function correctly, it is necessary that the glass membrane (bulb of electrode) be hydrated. This is achieved by conditioning the electrode in pH buffer or recommended aqueous solution. During non-aqueous titrations, the glass membrane of the pH electrode is gradually dehydrated, reducing the response of the electrode. To improve performance, make sure to recondition the electrode between non-aqueous sample measurements.

Warranty Information

Thermo Fisher Scientific warrants to the original purchaser of any new merchandise that all items will be free of defects in material and workmanship for the periods set forth below, when used under specified and normal operating conditions, in accordance with the operating limitation and procedures given in the instruction manuals, and when not subjected to accident, alteration, abuse or misuse of Thermo Fisher Scientific's products in unspecified applications, for unauthorized procedures, or with third-party products may void the warranty.

Thermo Scientific Orion Star T900 series titrators are warranted as follows:

Orion Star T900 series titrators are warranted for a period of one (1) year from the date of purchase. This warranty covers the instrument (including display, touchscreen, connections, boards) and integrated dispensing components (including burette drive assembly, valve assembly, burette). All consumable parts (including tubing, dispensing probe, reagent bottle cap) in contact with the sample are warranted for a period of ninety (90) days from the date of purchase.

Sample must be chemically compatible with the product. If parts are not compatible or if a question exists regarding compatibility, notify the factory before placing the product in service to maintain the warranty

THE WARRANTIES DESCRIBED ABOVE ARE EXCLUSIVE AND IN LIEU OF ALL OTHER WARRANTIES WHETHER STATUTORY, EXPRESSED OR IMPLIED. ALL OTHER WARRANTIES OF MERCHANTABILITY AND FITNESS FOR A PARTICULAR PURPOSE, AND ALL OTHER WARRANTIES ARISING FROM COURSE OF DEALING OR USAGE OF TRADE, EXCEPT TITLE, ARE HEREBY OVERRIDDEN AND EXCLUDED. NO LIABILITY SHALL ATTACH TO THERMO SCIENTIFIC EITHER IN CONTRACT OR IN TORT, FOR ANY PERSONAL INJURY, DEATH, DAMAGE TO PROPERTY, LOSS OF PROFITS, DAMAGES, COSTS, CHARGES, LIABILITIES OR EXPENSES, WHETHER DIRECT OR INDIRECT, CONSEQUENTIAL OR OTHERWISE, WHICH ARISE OUT OF OR IN CONJUNCTION WITH THE SALE OR USE OF THIS PRODUCT.

The customer's sole and exclusive remedy is the return of defective components or sub assemblies to Thermo Fisher Scientific for repair or replacement or, at Thermo Fisher Scientific's option, refund of the purchase price.

Warranty Shipments/ Returns/Adjustments

A warranty claim must be made promptly and must be received during the applicable warranty period by Thermo Fisher Scientific or your authorized Thermo Fisher Scientific distributor. If it becomes necessary to return a product for repair and/or adjustment, prior authorization from Thermo Fisher Scientific or your Thermo Fisher Scientific- authorized distributor must be obtained. Instructions as to how and where these products should be shipped will be provided by Thermo Scientific or your Thermo Scientific-authorized distributor.

Any product or component returned for examination and/or warranty repair shall be sent to Thermo Fisher Scientific in MA, or any of their authorized representatives. All items must be returned at the customer's cost (freight prepaid), quoting a return authorization number that is available from the Service department. All products or components repaired or replaced under warranty will be returned to the customer at Thermo Fisher Scientific's cost using UPS (United Parcel Service) or an equivalent service.

In all cases, Thermo Fisher Scientific or your Thermo Fisher Scientific-authorized distributor has sole responsibility for determining the cause and nature of failure, and Thermo Fisher Scientific's or the distributor's determination with regard thereto shall be final.

All parts that are replaced under warranty will become the property of Thermo Fisher Scientific.

Replacement Parts

Replacement parts can be ordered from Thermo Fisher Scientific or your Thermo Fisher Scientific-authorized distributor. Use only Thermo Fisher Scientific products or Thermo Fisher Scientific-approved products. Thermo Fisher Scientific shall not be liable for damage to or malfunction of the system, which it deems was caused by the use of unauthorized materials.

Technical Support Assistance

For any questions or if you require assistance, contact our Technical Support Specialists:

- Email wlp.techsupport@thermofisher.com
- Within the United States, call 1-800-225-1480
- Outside the United States, call +1-978-232-6000

For additional product information, contact your local authorized dealer, Thermo Scientific Orion technical sales representative or contact us using the contact information on the page back of this user manual.

Visit www.thermofisher.com/water to view Thermo Scientific Orion products and download product literature, user manuals and manuals, software updates, and additional application and technical resources.

Regulatory Statements

FCC USA

“This equipment has been tested and found to comply with the limits for a Class A digital device, pursuant to part 15 of the FCC Rules. These limits are designed to provide reasonable protection against harmful interference when the equipment is operated in a commercial environment. This equipment generates, uses, and can radiate radio frequency energy and, if not installed and used in accordance with the instruction manual, may cause harmful interference to radio communications. Operation of this equipment in a residential area is likely to cause harmful interference in which case the user will be required to correct the interference at his own expense.”

Industry Canada

“This ISM device complies with Canadian ICES-001. Cet appareil ISM est conforme à la norme NMB-001 du Canada

Korea EMC Warning Statement

EMC Registration is done on this equipment for business use only. It may cause interference when the product would be used in home.

This warning statement applies a product for business use.

사용자안내문

사 용 자 안 내 문
이 기기는 업무용 환경에서 사용할 목적으로 적합성평가를 받은 기기로서 가정용 환경에서 사용하는 경우 전파간섭의 우려가 있습니다.

※ 사용자 안내문은 “업무용 방송통신기자재”에만 적용한다.

Titrator Specifications

	T910 pH Titrator	T920 Redox Titrator	T930 Ion Titrator	T940 All-in-one Titrator
Titration Technique	Equivalence point or preset endpoint			
Incremental Technique	---	---	Multiple known addition (MKA)	
Equivalence Points	1 or 2			
Preset Endpoints	1, 2 or 3			
MKA Points	---	---	Up to 5	
Titration Types	Direct or back titration			
Blank Options	Fixed value or variable value using titration			
Cycles Per Titration Run	Up to 5 cycles per sample, option to exclude cycle results from average results and RSD calculations			
Titrant Determination	Standardization titration or manual concentration input			
Titration Process Control	Routine, quick, careful or user defined			
Titration Precision	±0.5 % RSD, dependent on environment and handling conditions			
Stirrer Probe Speeds	5 selectable speeds, 250 to 3700 RPM			
Sample ID	Auto-incremental, manual or off			
Titration Setup Wizard	Yes, using Start a New Titration workflow			
Customizable Methods	Up to 10 methods with optional password protection			
Methods Transfer	Import/export via USB flash drive, summary to computer software or compact printer			
Data Logs	Sample titration, titrant standardization, calibration, direct measure – 100 data sets each			
Data Log Export	CSV or Report (PDF) file			
Time and Date	Yes, with nonvolatile battery backup			
Direct Measure Modes	pH	Redox	Ion	pH, Redox, Ion
pH Range	-2.000 to 20.000 pH	---	---	-2.000 to 20.000 pH
pH Resolution	0.001, 0.01, 0.1 (user selectable)	---	---	0.001, 0.01, 0.1 (user selectable)
pH Relative Accuracy	±0.002 pH	---	---	±0.002 pH
mV Range	-2000.0 to +2000.0 mV	-2000.0 to +2000.0 mV	-2000.0 to +2000.0 mV	-2000.0 to +2000.0 mV
mV Resolution	0.1 mV	0.1 mV	0.1 mV	0.1 mV
mV Relative Accuracy	±0.2 mV	±0.2 mV	±0.2 mV	±0.2 mV
ISE Range	---	---	0.0001 to 19990	0.0001 to 19990
ISE Resolution	---	---	0.0001 minimum, 1 to 4 significant digits (user selectable)	0.0001 minimum, 1 to 4 significant digits (user selectable)
ISE Relative Accuracy	---	---	±0.2 mV or ±0.05% of reading, whichever is greater	±0.2 mV or ±0.05% of reading, whichever is greater
Temperature Range	-5.0 to 100.0 °C; 23.0 to 212 °F	-5.0 to 100.0 °C; 23.0 to 212 °F	-5.0 to 100.0 °C; 23.0 to 212 °F	-5.0 to 100.0 °C; 23.0 to 212 °F
Temperature Resolution	0.1 °C; 0.1 °F	0.1 °C; 0.1 °F	0.1 °C; 0.1 °F	0.1 °C; 0.1 °F

	T910 pH Titrator	T920 Redox Titrator	T930 Ion Titrator	T940 All-in-one Titrator
Temperature Relative Accuracy	±0.2 °C	±0.2 °C	±0.2 °C	±0.2 °C
Calibration Modes	1 to 5 point pH	1 point relative mV	1 to 5 point ion	1 to 5 point pH, 1 point relative mV, 1 to 5 point ion
Temperature Input	Manual or automatic with optional 1 point ATC probe offset calibration			
Display Type	5.7" color capacitive touchscreen, 640 x 480 resolution, with adjustable backlight and lab glove compatibility			
Languages	Chinese, English, French, German, Italian, Japanese, Korean, Portuguese, Russian, Spanish			
Audible Notifications	Titration Cycle Complete, Maximum Titrant Volume, Data Log Full, Calibration Due, Maintenance Reminder			
Updateable Firmware	Yes, using USB flash drive			
Burette Sizes	10 mL, 20 mL (included), 50 mL			
Burette Resolution	Advanced micro-step technology provides 25,600 micro-steps per motor revolution for smooth and precise burette positioning (2 million micro-steps over full burette stroke range)			
Burette Dosing Accuracy	Meets ISO8655-3 requirements			
Burette Functions	Automatic rinse cycles for flushing and discrete dispense volume with continuous option			
Certifications	CE, cTUVus, KC, NOM, RCM, Kvalitet, FCC, EN/EIC61326-1, IEC 61010, IP-51			
Weight and Dimensions	12.5 lbs, 10" x 16" x 14" (L x W x H); 5.67 kg, 25.4 cm x 40.6 cm x 35.6 (L x W x H)			
Power Requirements	100 to 240 V, 50/60 Hz			
Titrator Warranty	1 year			

Ordering Information

Titrators	
Cat. No	Description
START9100	Orion Star T910 pH titrator, includes 20 mL burette, stirrer probe, dispenser probe, standard tubing kit, 1 L plastic bottle, GL38 bottle cap with drying tube, computer cable, literature on USB flash drive, 110-240 V power supplies
START9101	Orion Star T910 pH titrator standard ROSS kit, includes 8102BNUWP ROSS Ultra pH electrode, 927007MD ATC probe, 20 mL burette, stirrer probe, dispenser probe, standard tubing kit, 1 L plastic bottle, GL38 bottle cap with drying tube, computer cable, literature on USB flash drive, 110-240 V power supplies
START9102	Orion Star T910 pH titrator ROSS Sure-Flow kit, includes 8172BNWP ROSS Sure-Flow pH electrode, 927007MD ATC probe, 20 mL burette, stirrer probe, dispenser probe, standard tubing kit, 1 L plastic bottle, GL38 bottle cap with drying tube, computer cable, literature on USB flash drive, 110-240 V power supplies
START9200	Orion Star T920 redox titrator, includes 8172BNWP ROSS Sure-Flow pH electrode, 927007MD ATC probe, 20 mL burette, stirrer probe, dispenser probe, standard tubing kit, 1 L plastic bottle, GL38 bottle cap with drying tube, computer cable, literature on USB flash drive, 110-240 V power supplies
START9201	Orion Star T920 redox titrator kit, includes 9778BNWP glass-body redox electrode, 20 mL burette, stirrer probe, dispenser probe, standard tubing kit, 1 L plastic bottle, GL38 bottle cap with drying tube, computer cable, literature on USB flash drive, 110-240 V power supplies
START9300	Orion Star T930 ion titrator, includes 20 mL burette, stirrer probe, dispenser probe, standard tubing kit, 1 L plastic bottle, GL38 bottle cap with drying tube, computer cable, literature on USB flash drive, 110-240 V power supplies
START9301	Orion Star T930 ion titrator chloride/salt kit, includes 9780SC silver billet electrode, 91CBNC electrode cable, 20 mL burette, stirrer probe, dispenser probe, standard tubing kit, 1 L plastic bottle, GL38 bottle cap with drying tube, computer cable, literature on USB flash drive, 110-240 V power supplies
START9302	Orion Star T930 ion titrator chloride multiple known addition (MKA) kit, includes 9617BNWP chloride electrode, 20 mL burette, stirrer probe, dispenser probe, standard tubing kit, 1 L plastic bottle, GL38 bottle cap with drying tube, pint bottle cap, computer cable, literature on USB flash drive, 110-240 V power supplies
START9303	Orion Star T930 ion titrator sodium multiple known addition (MKA) kit, includes 8611BNWP ROSS sodium electrode, 20 mL burette, stirrer probe, dispenser probe, standard tubing kit, 1 L plastic bottle, GL38 bottle cap with drying tube, pint bottle cap, computer cable, literature on USB flash drive, 110-240 V power supplies
START9304	Orion Star T930 ion titrator ammonia multiple known addition (MKA) kit, includes 9512HPBNWP high performance ammonia electrode, 20 mL burette, stirrer probe, dispenser probe, standard tubing kit, 1 L plastic bottle, GL38 bottle cap with drying tube, pint bottle cap, computer cable, literature on USB flash drive, 110-240 V power supplies
START9305	Orion Star T930 ion titrator surfactant kit, includes 9342BN surfactant electrode, 900200 reference electrode, 20 mL burette, stirrer probe, dispenser probe, standard tubing kit, 1 L plastic bottle, GL38 bottle cap with drying tube, computer cable, literature on USB flash drive, 110-240 V power supplies
START9306	Orion Star T930 ion titrator total hardness kit, includes 9720BNWP calcium electrode, 20 mL burette, stirrer probe, dispenser probe, standard tubing kit, 1 L plastic bottle, GL38 bottle cap with drying tube, computer cable, literature on USB flash drive, 110-240 V power supplies
START9400	Orion Star T940 all-in-one titrator, includes 20 mL burette, stirrer probe, dispenser probe, standard tubing kit, 1 L plastic bottle, GL38 bottle cap with drying tube, computer cable, literature on USB flash drive, 110-240 V power supplies
START9401	Orion Star T940 all-in-one titrator standard ROSS kit, includes 8102BNUWP ROSS Ultra pH electrode, 927007MD ATC probe, 20 mL burette, stirrer probe, dispenser probe, standard tubing kit, 1 L plastic bottle, GL38 bottle cap with drying tube, computer cable, literature on USB flash drive, 110-240 V power supplies

START9402	Orion Star T940 all-in-one titrator ROSS Sure-Flow kit, includes 8172BNWP ROSS Sure-Flow pH electrode, 927007MD ATC probe, 20 mL burette, stirrer probe, dispenser probe, standard tubing kit, 1 L plastic bottle, GL38 bottle cap with drying tube, computer cable, literature on USB flash drive, 110-240 V power supplies
-----------	--

Titration Accessories and Consumables

Cat. No	Description
STARA-106	Orion compact ink ribbon printer, 100-240 V
STARA-108	Replacement ink ribbon for Orion compact ink ribbon printer, 6 pack
STARA-109	Replacement paper rolls for Orion compact ink ribbon printer, 5 pack
096019	Orion stirrer probe
096021	Replacement stirrer paddles for Orion stirrer probe
START-B00	Orion Star T900 series burette cover
START-B10	Orion Star T900 series 10 mL burette
START-B20	Orion Star T900 series 20 mL burette
START-B50	Orion Star T900 series 50 mL burette
START-BT0	Orion Star T900 series reagent bottle holder
START-BT1	Orion Star T900 series 1 L plastic bottle
START-BT2	Orion Star T900 series 1 L glass amber bottle
START-BT3	Orion Star T900 series 1 L plastic bottles, 12 pack
START-BT4	Orion Star T900 series 1 L glass amber bottles, 12 pack
START-CP1	Orion Star T900 series GL38 reagent bottle cap
START-CP2	Orion Star T900 series GL45 reagent bottle
START-CP3	Orion Star T900 series Orion pint bottle cap
START-DS1	Orion Star T900 series dispenser probe
START-DVK	Orion Star T900 series dispense verification kit
START-EH1	Orion Star T900 series electrode holder assembly
START-EH2	Orion Star T900 series stopper for electrode holder
START-EH3	Orion Star T900 series cable management clips
START-PS1	Orion Star T900 series 110 V US/Japan power supply
START-PS2	Orion Star T900 series 220 V Euro power supply
START-PS3	Orion Star T900 series 240 V UK/Singapore power supply
START-PS4	Orion Star T900 series 230 V Australia/New Zealand power supply
START-PS5	Orion Star T900 series 220 V China power supply
START-TB1	Orion Star T900 series standard tubing kit, one each of burette, reagent bottle and dispenser tubing
START-TB2	Orion Star T900 series light blocking tubing kit, one each of burette, reagent bottle and dispenser tubing with light blocking opacity
START-TB3	Orion Star T900 series drying tube
START-TB4	Orion Star T900 series burette tubing
START-TB5	Orion Star T900 series reagent bottle tubing
START-TB6	Orion Star T900 series dispenser tubing

START-UM1	Orion Star T900 series user manual on USB flash drive
START-USB	Orion Star T900 series USB computer cable
START-VK1	Orion Star T900 series valve replacement kit

pH Electrodes and Solutions

Cat. No	Description
8102BNUWP	ROSS Ultra glass-body refillable pH electrode, BNC connector
8172BNWP	ROSS Sure-Flow glass-body refillable pH electrode, BNC connector
8156BNUWP	ROSS Ultra epoxy-body refillable pH electrode, BNC connector
8165BNWP	ROSS Sure-Flow epoxy-body refillable pH electrode, BNC connector
8302BNUMD	ROSS Ultra Triode glass-body refillable pH/ATC electrode, BNC & MiniDIN connectors
8157BNUMD	ROSS Ultra Triode epoxy-body refillable pH/ATC electrode, BNC & MiniDIN connectors
927006MD	Orion ATC temperature probe with glass body, MiniDIN connector
927007MD	Orion ATC temperature probe with stainless steel body, MiniDIN connector
810199	ROSS All-in-One pH buffer and storage solution kit, includes pH 4, 7, 10 buffers; ROSS storage solution; pH electrode cleaning solution; pH electrode storage bottle
810001	ROSS pH electrode storage solution, 475 mL
810007	ROSS pH electrode filling solution, 5 x 60 mL
900023	pH electrode cleaning solution C for general cleaning, 4 x 30 mL, beaker and pipette
910168	Orion pH 1.68 buffer, 475 mL
910104	Orion pH 4.01 buffer, 475 mL
910686	Orion pH 6.86 buffer, 475 mL
910107	Orion pH 7.00 buffer, 475 mL
910918	Orion pH 9.18 buffer, 475 mL
910110	Orion pH 10.01 buffer, 475 mL
910112	Orion pH 12.46 buffer, 475 mL

ORP / Redox Electrodes and Solutions

Cat. No	Description
9778BNWP	Orion ORP / redox glass-body refillable electrode, BNC connector
9678BNWP	Orion ORP / redox Sure-Flow epoxy-body refillable electrode, BNC connector
9180BNMD	Orion ORP / redox / ATC Triode epoxy-body refillable electrode, BNC & MiniDIN connectors
900011	Orion ORP / redox electrode filling solution, 5 x 60 mL
967901	Orion ORP standard solution, 475 mL

Ion Selective Electrodes (ISE) and Solutions

Cat. No	Description
9780SC	Orion Silver Billet argentometric titration endpoint indicator, screw cap
91CBNC	Orion screw cap electrode to BNC meter cable
900011	Orion Silver Billet electrode filling solution, 5 x 60 mL
9720BNWP	Orion calcium ion selective electrode, BNC connector
922006	Orion 0.1 M CaCl ₂ calcium standard, 475 mL

932011	Orion calcium ionic strength adjuster (ISA), 475 mL
900061	Orion calcium electrode filling solution, 5 x 60 mL
9617BNWP	Orion chloride ion selective electrode, BNC connector
941706	Orion 0.1 M NaCl chloride standard, 475 mL
940011	Orion chloride ionic strength adjuster (ISA), 475 mL
900062	Orion chloride electrode filling solution, 5 x 60 mL
9609BNWP	Orion fluoride ion selective electrode, BNC connector
940906	Orion 0.1 M NaF fluoride standard, 475 mL
940909	Orion TISAB II total ionic strength adjustment buffer for fluoride analysis, 3.8 L
900061	Orion fluoride electrode filling solution, 5 x 60 mL
9707BNWP	Orion nitrate ion selective electrode, BNC connector
920706	Orion 0.1 M NaNO ₃ nitrate standard, 475 mL
930711	Orion nitrate ionic strength adjuster (ISA), 475 mL
930710	Orion nitrate interference suppressor solution, 475 mL
900046	Orion nitrate electrode filling solution, 5 x 60 mL
9719BNWP	Orion potassium ion selective electrode, BNC connector
921906	Orion 0.1 M KCl potassium standard, 475 mL
931911	Orion potassium ionic strength adjuster (ISA), 475 mL
900065	Orion potassium electrode filling solution, 5 x 60 mL
9616BNWP	Orion silver/sulfide ion selective electrode, BNC connector
940011	Orion silver ionic strength adjuster (ISA), 475 mL
941609	Orion sulfide ionic strength adjuster (ISA), 475 mL
900062	Orion silver/sulfide electrode filling solution, 5 x 60 mL
8611BNWP	ROSS sodium ion selective electrode, BNC connector, includes solutions and standards for MKA
650700	Orion sodium known addition kit, includes 1 M NaCl sodium standard with ISA (3 x 475 mL) and sodium ionic strength adjuster (475 mL)
941706	Orion 0.1 M NaCl sodium standard, 475 mL
841111	Orion sodium ionic strength adjuster (ISA), 475 mL
900010	Orion sodium electrode filling solution, 5 x 60 mL
9342BN	Orion surfactant half-cell ion selective electrode, BNC connector
900200	Orion double junction reference half-cell electrode, pin-tip connector
654201	Orion hyamine surfactant standard, 475 mL
654202	Orion SLS surfactant standard, 60 mL
810007	Orion ROSS fill solution for double junction reference electrode used with surfactant ISE, 5 x 60 mL

Chapter 6

Appendix

Calculating a Reaction Ratio

- Write down the chemical reaction involved in the analysis you will be performing, then balance the equation. Here are some examples:

Sample	Titrant	Products
NaCl	+ AgNO ₃	= AgCl + NaNO ₃
CaCl ₂	+ 2 AgNO ₃	= 2 AgCl + Ca(NO ₃) ₂
NaOH	+ HCl	= NaCl + H ₂ O
2 NaOH	+ H ₂ SO ₄	= Na ₂ SO ₄ + 2 H ₂ O

- To calculate the reaction ratio, divide the number of moles of titrant by the number of moles of sample.

Sample	Titrant	Products	Reaction Ratio
NaCl	+ AgNO ₃	= AgCl + NaNO ₃	1
CaCl ₂	+ 2 AgNO ₃	= 2 AgCl + Ca(NO ₃) ₂	0.5
NaOH	+ HCl	= NaCl + H ₂ O	1
2 NaOH	+ H ₂ SO ₄	= Na ₂ SO ₄ + 2 H ₂ O	2

For example, when performing a titratable acidity titration with orange juice, the sample is citric acid (C₆H₈O₇) and the titrant is sodium hydroxide (NaOH), so the chemical reaction is C₆H₈O₇ + 3 NaOH = 3 H₂O + Na₃C₆H₅O₇ and the reaction ratio is 0.333.

When performing a titratable acidity titration with wine, the sample is tartaric acid (C₄H₆O₆) and the titrant is sodium hydroxide (NaOH) so the chemical reaction is C₄H₆O₆ + 2 NaOH = 2 H₂O + Na₂C₄H₂O₄ and the reaction ratio is 0.5.

Selecting the Result Units

Select the result units from the list shown on the titrator. The selected units will determine which parameters need to be entered to calculate the titration sample concentration results. Available result units include those listed here and new result units are added through titrator software updates.

Titration Result Units

Units	Definition
M	Molar, moles per liter
mM	Millimolar, millimoles per liter
mg/100mL	Milligrams per 100 milliliters
mg/L	Milligrams per liter
g/100mL	Grams per 100 milliliters
g/L	Grams per liter
ppm	Parts per million
ppb	Parts per billion
oz/gal	Ounces per gallon
% w/v	Percent weight per volume
mol/kg	Moles per kilogram
mmol/kg	Millimoles per kilogram
mmol/g	Millimoles per gram
mg/100g	Milligrams per 100 grams
mg/g	Milligrams per gram
mg/kg	Milligrams per kilogram
g/100g	Grams per 100 grams
g/kg	Grams per kilogram
ppm by weight	Parts per million on a weight basis
% w/w	Percent weight per weight
TAN	Total acid number - quantity of base, expressed in milligrams of potassium hydroxide (KOH) required to neutralize all acidic constituents present in 1 gram of sample
TBA	Total base number - quantity of acid, expressed in the equivalent number of milligrams of potassium hydroxide (KOH) required to neutralize all basic constituents present in 1 gram of sample
Consumption mmol	Millimoles of sample consumed during the titration
F * consumption mmol	Enter a value for the F factor and the entered factor value will be multiplied by the millimoles of sample consumed during the titration

MKA Result Units

Units	Definition
M	Molar, moles per liter
mM	Millimolar, millimoles per liter
mg/100mL	Milligrams per 100 milliliters
mg/L	Milligrams per liter
g/100mL	Grams per 100 milliliters
g/L	Grams per liter
ppm	Parts per million
ppb	Parts per billion
oz/gal	Ounces per gallon
% w/v	Percent weight per volume
% w/w	Percent weight per weight
ppm (w)	Parts per million on a weight basis
mg/g	Milligrams per gram
mg/serving	Milligrams per serving
mg	Milligrams

Titrator Calculations

The Orion Star T900 series titrators calculate concentrations of samples based on the equivalent amounts of titrants consumed at the determined endpoints; the titrators can report and print results in a number of different units.

Direct Titration Calculations

In direct titration, the titrant directly reacts with the sample:



Calculations are based on equivalent amount of sample and titrant following relationship:

$$\text{Moles of Sample} = \text{Fdr} * (\text{Moles of Titrant Consumed})$$

where **Fdr** is the reaction ratio of the titration reaction; it is equal to the number of sample molecules required to react with one molecule of the titrant

For example, in the titration reaction below using NaOH as the titrant to titrate a sample of H₂SO₄, the **Fdr** is 0.5:

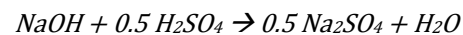

Orion Star T900 series titrators require that titrant concentration be in molarity (M) or millimolarity (mM) units.

Assuming that the titrant concentration **Ct** is in molarity (M) and the volume of the titrant consumed to reach the endpoint is **VtEP** in milliliters (mL), the following is true:

$$\text{Sample (millimoles)} = \text{Ct} * \text{VtEP} * \text{Fdr}$$

If the sample is measured by **Vs** in mL, then:

$$\text{Cs} * \text{Vs} = \text{Ct} * \text{VtEP} * \text{Fdr}$$

Concentration of the sample **Cs** in M can be calculated by:

$$\text{Cs} = \frac{\text{Ct} * \text{VtEP} * \text{Fdr}}{\text{Vs}}$$

Blank Correction in Direct Titration

Sometimes, sample preparation may introduce a blank value. For the most accurate results, the blank value should be subtracted from the determined total concentration. In Orion Star T900 series titrators, the amount of blank may be entered in millimoles if it is known to the user, or it may be determined by running a blank titration before the sample titration is performed. The following titration results are then blank corrected.

$$\text{Blank} = \text{Ct} * (\text{VtEP})_{\text{blk}} * \text{Fdr}$$

$$C_s = \frac{(C_t * V_{tEP} * F_{dr}) - Blank}{V_s}$$

If the sample is measured by weight and/or concentration results other than M is required, the titrator will require that the user to enter the necessary information about the sample, such as density (**Ds**) and molecular weight (**MWs**), in the titration setup and the results are automatically calculated and reported at the end of the titration. Here are a few examples of calculations based on the selected units:

Calculation Examples, Assuming Ct is in Molar (M)

For sample units of Vs in mL and result units of Cs in mM:

$$C_s = \frac{(C_t * V_{tEP} * F_{dr}) - Blank}{V_s} * 1000$$

For sample units of Ws in grams and result units of Cs in M:

$$C_s = \frac{(C_t * V_{tEP} * F_{dr}) - Blank}{W_s / D_s}$$

For sample units of Vs in mL and result units of Cs in g/L:

$$C_s = \frac{(C_t * V_{tEP} * F_{dr}) - Blank}{V_s} * MW_s$$

For sample units of Ws in grams and result units of Cs in ppm (mg/Kg):

$$C_s = \frac{(C_t * V_{tEP} * F_{dr}) - Blank}{W_s} * MW_s * 1000$$

For sample units of Vs in mL and result units of TAN (mg KOH/g):

$$C_s = \frac{(C_t * V_{tEP} * F_{dr}) - Blank}{V_s * D_s} * 56.106$$

For sample units of Ws in grams and result units of TBN (mg KOH/g):

$$C_s = \frac{(C_t * V_{tEP} * F_{dr}) - Blank}{W_s} * 56.106$$

Back Titration Calculations

Back titrations involve (1) adding excessive, known amount of reagent to the sample solution to react with the sample followed by (2) titrating the residual amount of reagent by titrant. The approach provides a way to avoid using a sluggish reaction for titration. Both analysis speed and accuracy can be greatly improved.

For example, the total base number (TBN) of an oil sample can be determined by adding extra amount of a strong acid to the sample, after sample reaction is completed, back titrating the residual strong acid with a strong base. The difference between the total amount of the strong acid added to the sample and the residual amount of the strong acid determined by titration is used to calculate the amount of TBN in the sample.

Reaction Ratios in Back Titration

In back titrations, the reaction ratio **Fdr** is the number of the residual reagent molecules required to react with one molecule of titrant. In addition, there is a reagent reaction ratio, **Fbk**, the stoichiometry of the reaction between the sample and the reagent. It is equal to the number of sample molecules required to react with one molecule of reagent.

Looking at a possible back titration case, in which the sample is sodium phosphate Na_3PO_4 . An extra amount of reagent of silver nitrate $AgNO_3$ is added to the sample to form silver phosphate Ag_3PO_4 precipitate. The residual reagent of $AgNO_3$ is titrated by titrant sodium sulfide Na_2S .

Reagent reaction:

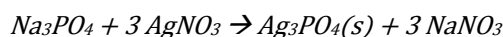

Titration reaction:

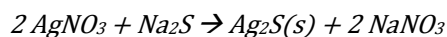

$$F_{bk} = Sample / Reagent = Na_3PO_4 / AgNO_3 = 1/3 = 0.3333$$

$$F_{dr} = Reagent / Titrant = AgNO_3 / Na_2S = 2/1 = 2$$

Amount of Reagent in Back Titration

In Orion Star T900 series titrators, the amount of reagent **Rbk** in back titrations can be entered in different ways or can be determined by running a blank titration in which the sample is absent. The value can be calculated in millimoles (mmol). One of the following formula can be used.

$$R_{bk} = C_{bk} * V_{bk}$$

where **C_{bk}** and **V_{bk}** are the concentration in M and volume in mL of the reagent used

$$C_s = \frac{R_{bk} - (C_t * V_{tEP} * F_{dr})}{W_s} * F_{bk} * 56.106$$

$$R_{bk} = \frac{W_{bk} * (\%Purity)_{bk}}{(MW)_{bk}} * 1000$$

where **W_{bk}**, **(%Purity)_{bk}** and **(MW)_{bk}** are the weight in grams, purity in % and the molecular weight of the reagent

$$R_{bk} = C_t * V_{tEP0} * F_{dr}$$

where **V_{tEP0}** is the endpoint volume determined in the blank titration

Concentration Calculation in Back Titration

The difference between **R_{bk}** and the consumed titrant is used to calculate the sample concentration. Here are a few examples of calculations based on the selected units:

Back Titration Calculation Examples, Assuming **C_t** is in Molar (M)

For sample units of **V_s** in mL and result units of **C_s** in mM:

$$C_s = \frac{R_{bk} - (C_t * V_{tEP} * F_{dr})}{V_s} * F_{bk} * 1000$$

For sample units of **W_s** in grams and result units of **C_s** in M:

$$C_s = \frac{R_{bk} - (C_t * V_{tEP} * F_{dr})}{W_s / D_s} * F_{bk}$$

For sample units of **V_s** in mL and result units of **C_s** in g/L:

$$C_s = \frac{R_{bk} - (C_t * V_{tEP} * F_{dr})}{V_s} * F_{bk} * MW_s$$

For sample units of **W_s** in grams and result units of **C_s** in ppm (mg/Kg):

$$C_s = \frac{R_{bk} - (C_t * V_{tEP} * F_{dr})}{W_s} * F_{bk} * MW_s * 1000$$

For sample units of **V_s** in mL and result units of TAN (mg KOH/g):

$$C_s = \frac{R_{bk} - (C_t * V_{tEP} * F_{dr})}{V_s * D_s} * F_{bk} * 56.106$$

For sample units of **W_s** in grams and result units of TBN (mg KOH/g):

Multiple Endpoints

For titrations having multiple endpoints, the Orion Star T900 titrators report the concentration determined at each endpoint. More specific information can then be calculated by the user from the results.

For example, the total hardness of a sample can be determined by titrating with EDTA titrant. If both calcium and magnesium ions are present in the sample, two endpoints will be determined. One example is illustrated below.

Chart 6.3: Total Hardness Titration by EDTA Indicated by Calcium Ion Selective Electrode with Acetylacetone Reagent

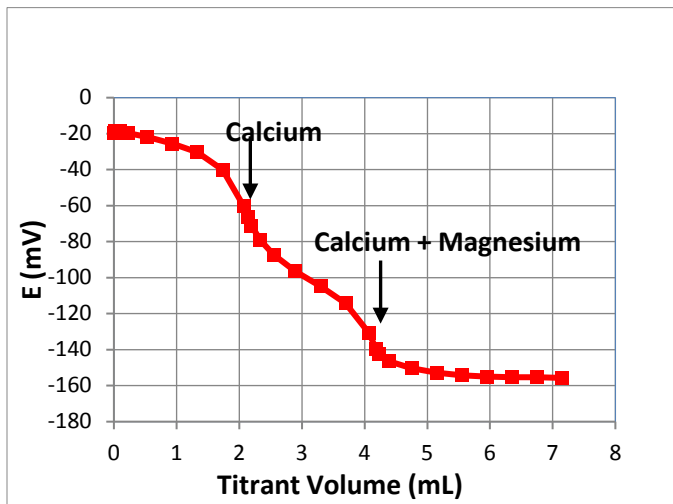

The titrator will report two concentrations, C1 and C2.

C1 = Calcium concentration in sample as CaCO₃

C2 = Calcium concentration + Magnesium concentration in sample as CaCO₃

The user can easily calculate the magnesium concentration in the sample by subtracting C1 from C2 and converting from units of CaCO₃ to units of Mg.

Titration Standardization

In Orion Star T900 series titrators, the concentration of the titrant can be entered in M or mM if the value is known. The concentration of the titrant can also be determined by standardization. Standardization is to determine the exact concentration of a titrant by using it to titrate a known amount of standard.

Standardization reaction ratio **Fstd** is the stoichiometry of the reaction between the standard and the titrant. It is equal to the number of standard molecules required to react with one molecule of titrant.

The amount of standard used in a standardization can be entered in different ways. The value Std (mmoles) can be calculated by one of the following formulas:

$$Std(\text{mmoles}) = C_{std} * V_{std}$$

where **Cstd** and **Vstd** are the concentration in M and volume in mL of the standard used

$$Std(\text{mmoles}) = \frac{W_{std} * (\%Purity)_{std}}{(MW)_{std}} * 1000$$

where **Wstd**, **(%Purity)std** and **(MW)std** are the weight in gram, purity in % and the molecular weight of the standard

At the end of standardization titration, based on the endpoint volume **VtEP**, the concentration of the titrant Ct in M can be calculated by the formula below

$$C_t = \frac{Std(\text{mmoles})}{V_{tEP} * F_{std}}$$

Multiple Known Addition (MKA)

Multiple Known Addition (MKA) is a method that by adding known standard of the species and measuring the signal change to estimate the unknown concentration of the species in the original sample.

Orion Star T900 series titrators offer a special analysis tool called MKA for analytes that are not "titratable" because they do not readily react with other chemicals to change chemical signals. Two of the examples are sodium (Na^+) and ammonia (NH_3). MKA has the advantages versus direct measurement of reducing or eliminating matrix effects and improving tolerance to electrode calibration drift.

In MKA, concentration determination is based on linear relationship of measured potential $E(\text{mV})$ versus the logarithm of concentration $\log C$.

Sample only:

$$E_0 = E' + \text{Slope} * \log (C_0)$$

After 1st addition:

$$E_1 = E' + \text{Slope} * \log \frac{C_0 * V_{tot} + C_t * V_1}{V_{tot} + V_1}$$

After 2nd addition:

$$E_2 = E' + \text{Slope} * \log \frac{C_0 * V_{tot} + C_t * (V_1 + V_2)}{V_{tot} + V_1 + V_2}$$

After 3rd addition:

$$E_3 = E' + \text{Slope} * \log \frac{C_0 * V_{tot} + C_t * (V_1 + V_2 + V_3)}{V_{tot} + V_1 + V_2 + V_3}$$

where E' and **Slope** are the calibration constants of the electrodes in the run; V_{tot} is the total solution volume after sample preparation; V_1 , V_2 , V_3 , ..., are the added volume of the titrant at each step

Solving equations by nonlinear regression analysis can obtain E' and **Slope** as well as the sample concentration (**C_0 in M**).

The titrator will conclude the analysis based on the precision criteria set by the user. It is noted that more additions can improve the precision, but more additions take the the solution further away from the initial sample concentration, which would demand the electrode to have a perfect linearity over a large range.

If there is a blank concentration (**$(\text{Blank})_{KA}$**) that needs to be corrected for, the value can be entered in setup or can be determined by a blank run. In this case, C_0 is replaced by $C_0 - (\text{Blank})_{KA}$ in the above equations

From $C_0 - (\text{Blank})_{KA}$ the concentration of the original sample C_s is calculated. Here are a few examples of calculations based on the selected units:

Calculation Examples in MKA, C_0 is Determined Concentration from MKA in M

For sample units of V_s in mL and result units of C_s in mM:

$$C_s = \frac{(C_0 - (\text{Blank})_{KA}) * V_{tot}}{V_s} * 1000$$

For sample units of W_s in gram and result units of C_s in M:

$$C_s = \frac{(C_0 - (\text{Blank})_{KA}) * V_{tot}}{W_s / D_s}$$

For sample units of V_s in mL and result units of C_s in g/L:

$$C_s = \frac{(C_0 - (\text{Blank})_{KA}) * V_{tot}}{V_s} * MW_s$$

For sample units of W_s in gram and result units of C_s in ppm (mg/ Kg):

$$C_s = \frac{(C_0 - (\text{Blank})_{KA}) * V_{tot}}{W_s} * MW_s * 1000$$

For sample units of Serving No. and result units of C_s in mg/serving:

$$C_s = \frac{(C_0 - (\text{Blank})_{KA}) * V_{tot}}{\text{Serving No.}} * MW_s * 1000$$

User Defined Results

In some cases, users may want to set up a special unit for their results. Orion Star T900 titrators offer an option of User Defined to allow the flexibility.

When the unit is User Defined, the user is asked to enter a **Factor**. The titration will first determine the amount of sample based on the consumed titrant or reagent, Consumption, in millimoles, then reports the result by multiplying the amount by the Factor.

In Direction Titration:

$$Consumption = \frac{(Ct * VtEP) - Blank}{Fdr}$$

In Back Titration:

$$Consumption = Rbk - (Ct * VtEP * Fdr)$$

In Either Titration:

$$C(Sample) = Factor * Consumption$$

User Notes

thermo scientific



Find out more at thermofisher.com/titrator

Water and Lab Products | wlp.techsupport@thermofisher.com

This product is intended for General Laboratory Use in accordance with our performance claims. It is the customers responsibility to ensure the performance is suitable for their specific use or application. © 2019 Thermo Fisher Scientific Inc. All rights reserved. All trademarks are the property of Thermo Fisher Scientific and its subsidiaries unless otherwise specified.

ThermoFisher
SCIENTIFIC