

I/O Module System

for Infrared Linescanners and Thermal Imagers



Users Manual

PN 4994027, English, Rev. 1.1, May 2018

© 2018 Fluke Process Instruments. All rights reserved. Printed in Germany. Specifications subject to change without notice.
All product names are trademarks of their respective companies.

Warranty

The manufacturer warrants this instrument to be free from defects in material and workmanship under normal use and service for the period of two years from date of purchase. This warranty extends only to the original purchaser. This warranty shall not apply to fuses, batteries, or any product which has been subject to misuse, neglect, accident, or abnormal conditions of operation.

In the event of failure of a product covered by this warranty, the manufacturer will repair the instrument when it is returned by the purchaser, freight prepaid, to an authorized Service Facility within the applicable warranty period, provided manufacturer's examination discloses to its satisfaction that the product was defective. The manufacturer may, at its option, replace the product in lieu of repair. With regard to any covered product returned within the applicable warranty period, repairs or replacement will be made without charge and with return freight paid by the manufacturer, unless the failure was caused by misuse, neglect, accident, or abnormal conditions of operation or storage, in which case repairs will be billed at a reasonable cost. In such a case, an estimate will be submitted before work is started, if requested.

The foregoing warranty is in lieu of all other warranties, expressed or implied, including but not limited to any implied warranty of merchantability, fitness, or adequacy for any particular purpose or use. The manufacturer shall not be liable for any special, incidental or consequential damages, whether in contract, tort, or otherwise.

Software Warranty

The manufacturer does not warrant that the software described herein will function properly in every hardware and software environment. This software may not work in combination with modified or emulated versions of Windows operating environments, memory-resident software, or on computers with inadequate memory. The manufacturer warrants that the program disk is free from defects in material and workmanship, assuming normal use, for a period of one year. Except for this warranty, the manufacturer makes no warranty or representation, either expressed or implied, with respect to this software or documentation, including its quality, performance, merchantability, or fitness for a particular purpose. As a result, this software and documentation are licensed "as is," and the licensee (i.e., the User) assumes the entire risk as to its quality and performance. The liability of the manufacturer under this warranty shall be limited to the amount paid by the User. In no event shall the manufacturer be liable for any costs including but not limited to those incurred as a result of lost profits or revenue, loss of use of the computer software, loss of data, the cost of substitute software, claims by third parties, or for other similar costs. The manufacturer's software and documentation are copyrighted with all rights reserved. It is illegal to make copies for another person.

Table of Contents

Chapter	Page
TABLE OF CONTENTS	3
LIST OF TABLES	5
LIST OF FIGURES	6
COMPLIANCE STATEMENT	7
SAFETY INFORMATION	8
CONTACTS	11
1 DESCRIPTION	12
1.1 Part Numbers	13
1.2 Power Supply	13
1.2.1 Isolation	13
1.2.2 Field Supply	14
1.2.2.1 Connection.....	14
1.3 Grounding.....	14
1.3.1 Grounding the DIN Rail.....	14
1.3.1.1 Framework Assembly	14
1.3.1.2 Insulated Assembly.....	15
1.3.2 Grounding Function	15
1.3.3 Grounding Protection	15
1.4 Shielding (Screening)	16
1.4.1 General	16
1.4.2 Bus Conductors	16
1.4.3 Signal Conductors.....	16
2 FIELDBUS COUPLER	17
2.1 View.....	17
2.2 Connectors	17
2.2.1 Device Supply	17
2.2.2 Fieldbus Connection	18
2.3 Display Elements.....	19
2.3.1 Indicators.....	19
2.3.2 Fieldbus Status	20
2.3.3 Node Status	20
2.4 Address Selection Switch.....	21
3 ASSEMBLY	22
3.1 Installation Position	22
3.2 Total Extension.....	22

3.3 Assembly onto Carrier Rail	22
3.3.1 Carrier Rail Properties	22
3.4 Spacing	23
3.5 Assembly Sequence	23
3.6 Inserting and Removing Devices	24
3.6.1 Inserting the Fieldbus Coupler	24
3.6.2 Removing the Fieldbus Coupler	25
3.6.3 Inserting I/O Module	25
3.6.4 Removing the I/O Module	26
4 CONNECT DEVICES	27
4.1 Data Contacts / Internal Bus	27
4.2 Power Contacts / Field Supply	27
4.3 Connecting a conductor to the CAGE CLAMP®	28
5 COMMISSIONING	29
5.1 Connecting Client PC and Fieldbus Nodes	29
5.2 Allocating the IP Address to the Fieldbus Node	29
5.2.1 Assigning the IP Address with a BootP Server	29
5.2.2 Assigning IP Address via Address Selection Switch	29
5.3 Restoring Factory Settings	30
6 SYSTEM COMPONENTS	31
6.1 Fieldbus Coupler 750-352	31
6.1 Relay Output Module 750-513	33
6.2 Relay Output Module 750-517	34
6.3 Digital Output Module 750-1504	35
6.4 Analog Output Module 750-562	36
6.5 Analog Output Module 750-563	37
6.6 Passive Isolator 857-452	38
6.7 Digital Input Module 750-1406	39
6.8 Supply Module 750-602	40
6.9 End Module 750-600	41
6.10 Power Supply 787-1002	42
7 APPLICATION EXAMPLES	43
7.1 Example 1: Relays	43
7.2 Example 2: Analog Out	44
7.3 Example 3: Relays, Analog Out, Digital Out	45

List of Tables

Table	Page
Table 2-1: RJ-45 Connector and RJ-45 Connector Configuration.....	18
Table 2-2: Display Elements Fieldbus Status.....	19
Table 2-3: Display Elements Node Status.....	19
Table 2-4: Fieldbus Diagnostics	20
Table 2-5: Node Status Diagnostics.....	20

List of Figures

Figure	Page
Figure 1-1: I/O Module System for the Infrared Device (Principle).....	12
Figure 1-2: I/O Fieldbus Coupler with I/O Modules, Example	12
Figure 1-3: Isolation	13
Figure 1-4: Field Supply (sensor/actuator).....	14
Figure 1-5: Carrier Rail Contact	15
Figure 1-6: Ring-feeding	16
Figure 2-1: View Ethernet TCP/IP Fieldbus Coupler.....	17
Figure 2-2: Device Supply.....	18
Figure 2-3: Display Elements	19
Figure 2-4: Address Selection Switch	21
Figure 3-1: Spacing.....	23
Figure 3-2: Unlocking Lug.....	24
Figure 3-3: Insert I/O module	25
Figure 3-4 Snap the I/O module into place	25
Figure 3-5 Removing the I/O module	26
Figure 4-1: Data Contacts.....	27
Figure 4-2: Example for the arrangement of power contacts	28
Figure 4-3: Connecting a conductor to a CAGE CLAMP®.....	28
Figure 5-1: Address selection switch	30
Figure 6-1: Fieldbus Coupler	31
Figure 6-2: Principle Circuit.....	31
Figure 6-3: Relay Output Module.....	33
Figure 6-4: Relay Output Module.....	34
Figure 6-5: Digital Output Module	35
Figure 6-6: Analog Output Module, V.....	36
Figure 6-7: Analog Output Module, mA.....	37
Figure 6-8: Passive Isolator	38
Figure 6-9: Digital Input Module.....	39
Figure 6-10: Supply Module.....	40
Figure 6-11: End Module	41
Figure 6-12: Power Supply Module.....	42

Compliance Statement

This document summarizes the relevant information on the I/O module system for Infrared Linescanners and Thermal Imagers. In case of missing information be referred to the full product description of the manufacturer WAGO for the WAGO I/O system 750.

Text and images courtesy of WAGO Kontakttechnik GmbH & Co. KG

Safety Information

These operating instructions are part of the Thermoview user manual. This document contains important information, which should be kept at all times with the instrument during its operational life. Other users of this instrument should be given these instructions with the instrument. Eventual updates to this information must be added to the original document. The instrument can only be operated by trained personnel in accordance with these instructions and local safety regulations.

Acceptable Operation

This documentation is only applicable to the I/O module system for Infrared Linescanners and Thermal Imagers. The system components shall only be installed and operated according to the instructions in this manual. The I/O modules receive digital and analog signals from the infrared device and transmit them to the actuators or higher-level control systems.















The components have been developed for use in an environment that meets the IP20 protection class criteria. Unless otherwise specified, operation of the components in wet and dusty environments is prohibited. Appropriate housing (per 94/9/EG) is required when operating the I/O module system in hazardous environments.

Unacceptable Operation

The instrument should not be used for medical diagnosis.

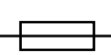
Replacement Parts and Accessories

Use only original parts and accessories approved by the manufacturer. The use of other products can compromise the operation safety and functionality of the instrument.

Safety Symbol	Description
	Read all safety information before in the handbook
	Hazardous voltage. Risk of electrical shock.
	Warning. Risk of danger. Important information. See manual.
	Laser warning
	AC (Alternating Current)
	DC (Direct Current)
	Earth (ground) terminal
	Protective conductor terminal
	Switch or relay contact
	Normally-open (NO) relay
	Normally-closed (NC) relay
	Fuse
	DC power supply
	Conforms to European Union directive.
	Disposal of old instruments should be handled according to professional and environmental regulations as electronic waste.



To prevent possible electrical shock, fire, or personal injury follow these guidelines:

- Read all safety information before you use the product.
- Use the product only as specified, or the protection supplied by the product can be compromised.
- **Do not work on components while energized!**
All power sources to the device shall be switched off prior to performing any installation, repair or maintenance work.
- **Installation only in appropriate housings, cabinets or in electrical operation rooms!**
The I/O modules and its components are an open system. As such, install the system and its components exclusively in appropriate housings, cabinets or in electrical operation rooms. Allow access to such equipment and fixtures to authorized, qualified staff only by means of specific keys or tools.
- **Replace defective or damaged devices!**
Replace defective or damaged device/module (e.g., in the event of deformed contacts), since the long-term functionality of fieldbus station involved can no longer be ensured.

Contacts

Fluke Process Instruments

America

Everett, WA USA

Tel: +1 800 227 8074 (USA and Canada, only)

+1 425 446 6300

solutions@flukeprocessinstruments.com

EMEA

Berlin, Germany

Tel: +49 30 478 0080

info@flukeprocessinstruments.de

China

Beijing, China

Tel: +86 10 6438 4691

info@flukeprocessinstruments.cn

Worldwide Service

Fluke Process Instruments offers services, including repair and calibration.

For more information, contact your local office.

www.flukeprocessinstruments.com

1 Description

The following figure shows the principle I/O Module System for Infrared Linescanners and Thermal Imagers based on a modular I/O system.

Figure 1-1: I/O Module System for the Infrared Device (Principle)

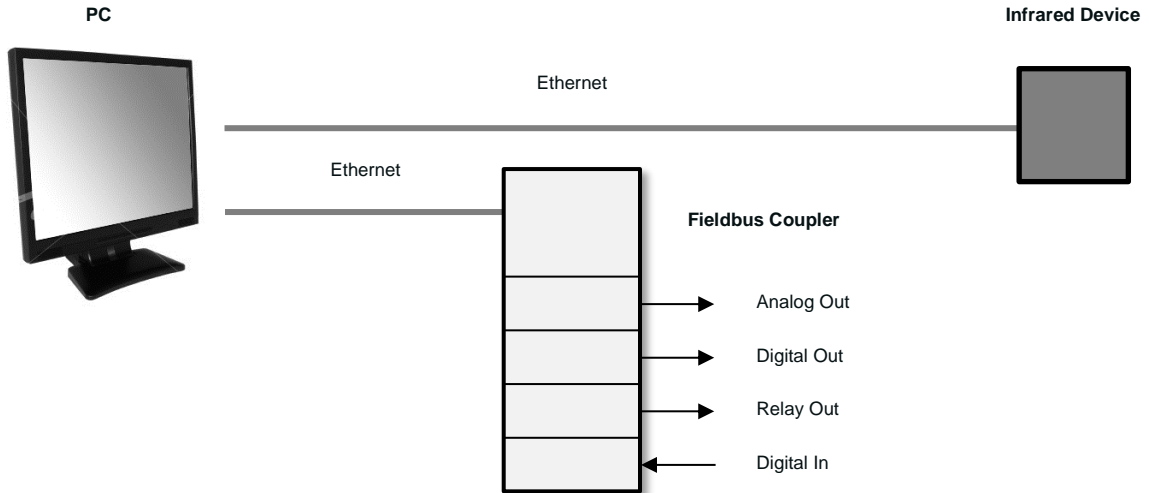

It is comprised of a fieldbus coupler (1) and connected fieldbus modules (2) for any type of signal. Together, these make up the fieldbus node. The end module (3) completes the node.

Figure 1-2: I/O Fieldbus Coupler with I/O Modules, Example

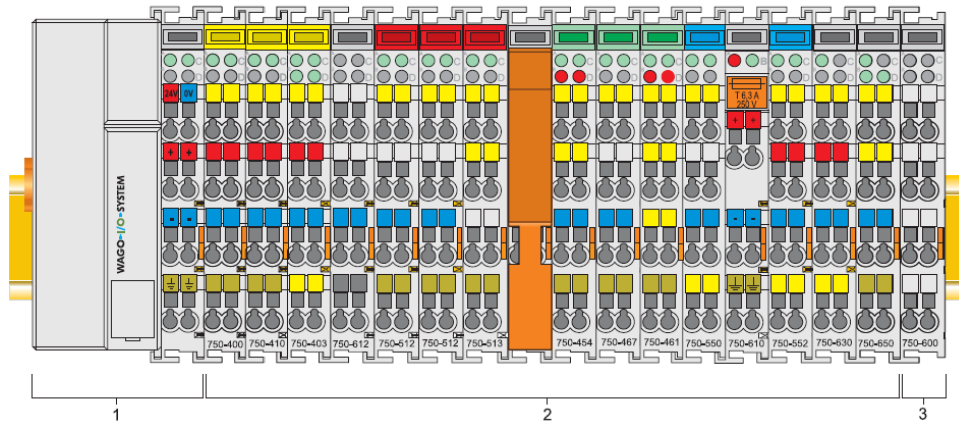

Bus modules for diverse digital and analog I/O functions can be connected to the fieldbus coupler. The communication between the coupler and the bus modules is carried out via an internal bus.

1.1 Part Numbers

The following components of the I/O module system are available through Fluke Process Instruments:

- Fieldbus Coupler 750-352
- Supply Module 750-602
- End Module 750-600
- Relay Output Module 750-513
- Relay Output Module 750-517
- Digital Output Module 750-1504
- Analog Output Module 750-562
- Analog Output Module 750-563
- Passive Isolator 857-452
- Digital Input Module 750-1406
- Power Supply 787-1002

1.2 Power Supply

1.2.1 Isolation

Within the fieldbus node, there are three electrically isolated potentials:

- electrically isolated fieldbus interface via transformer
- Electronics of the couplers and the bus modules (internal bus)
- All bus modules have an electrical isolation between the electronics (internal bus, logic) and the field electronics. Some digital and analog input modules have each channel electrically isolated.

Figure 1-3: Isolation

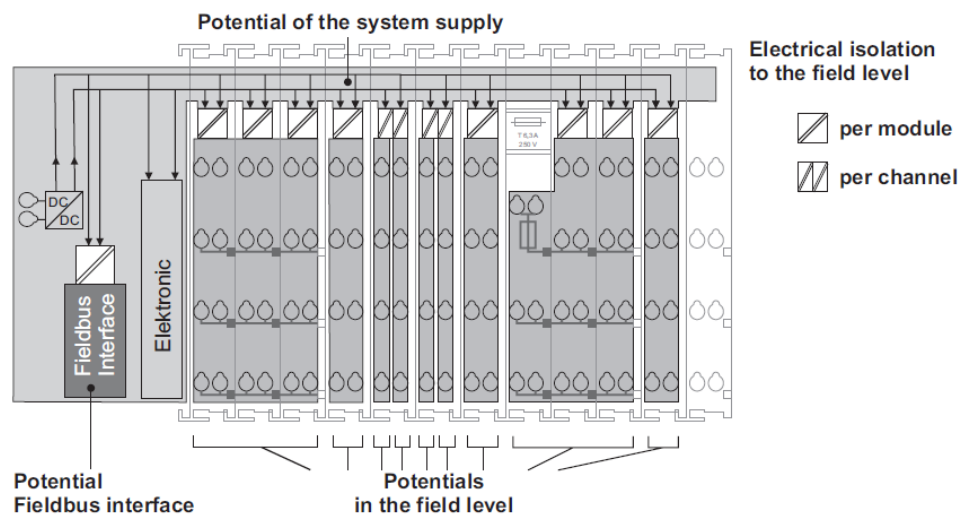

Ensure protective conductor function is present (via ring feeding if required)!

Pay attention, that the ground wire connection must be present in each group. In order that all protective conductor functions are maintained under all circumstances, it is recommended that a ground wire be connected at the beginning and the end of a potential group. Thus, if a bus module comes loose from a composite during servicing, then the protective conductor connection is still guaranteed for all connected field devices.

When you use a joint power supply unit for the 24 V system supply and the 24 V field supply, the electrical isolation between the internal bus and the field level is eliminated for the potential group.

1.2.2 Field Supply

1.2.2.1 Connection

Sensors and actuators can be directly connected to the relevant channel of the bus module in 1/4 conductor connection technology. The bus module supplies power to the sensors and actuators. The input and output drivers of some bus modules require the field side supply voltage.

For the field side power, a power supply module is necessary. Likewise, with the aid of the power supply modules, various potentials can be set up. The connections are linked in pairs with a power contact.

Figure 1-4: Field Supply (sensor/actuator)

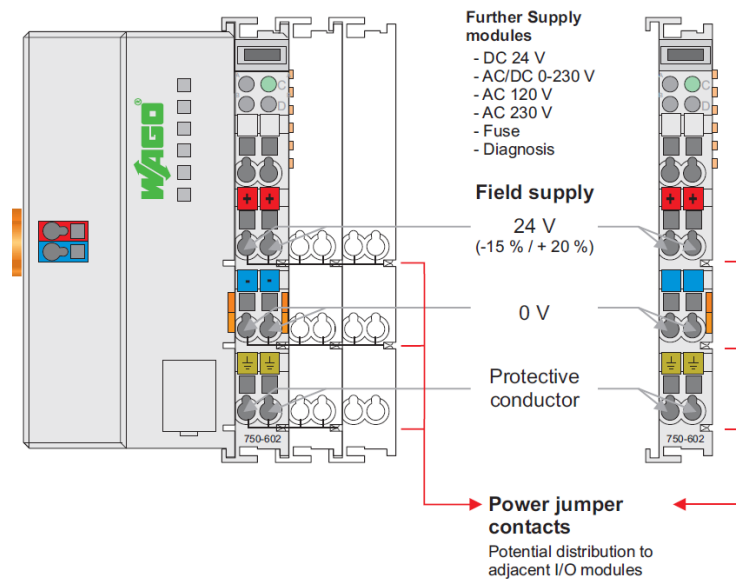

In exceptional instances, I/O modules can be directly connected to the field supply!

The 24 V field supply can be connected also directly to a bus module, if the connection points are not needed for the peripheral device supply. In this case, the connection points need the connection to the power jumper contacts.

1.3 Grounding

1.3.1 Grounding the DIN Rail

1.3.1.1 Framework Assembly

When setting up the framework, the carrier rail must be screwed together with the electrically conducting cabinet or housing frame. The framework or the housing must be grounded. The electronic connection is established via the screw. Thus, the carrier rail is grounded.



Ensure sufficient grounding is provided!

You must take care to ensure the flawless electrical connection between the carrier rail and the frame or housing in order to guarantee sufficient grounding.

1.3.1.2 Insulated Assembly

Insulated assembly has been achieved when there is constructively no direct conduction connection between the cabinet frame or machine parts and the carrier rail. Here the earth ground must be set up via an electrical conductor according to valid national safety regulations.

Recommendation

The optimal setup is a metallic assembly plate with grounding connection with an electrical conductive link with the carrier rail.

1.3.2 Grounding Function

The grounding function increases the resistance against disturbances from electromagnetic interferences. All components for the I/O module system have a carrier rail contact that dissipates electro-magnetic disturbances to the carrier rail.

Figure 1-5: Carrier Rail Contact

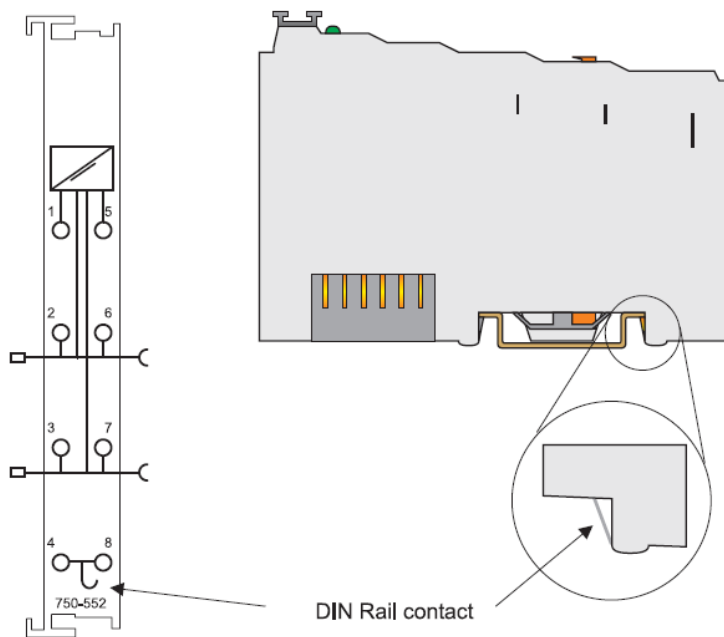

Ensure sufficient grounding is provided!

You must take care to ensure the direct electrical connection between the carrier rail contact and the carrier rail. The carrier rail must be grounded.

1.3.3 Grounding Protection

For the field side, the ground wire is connected to the lowest connection terminals of the power supply module. The ground connection is then connected to the next module via the Power Jumper Contact. If the bus module has the lower power jumper contact, then the ground wire connection of the field devices can be directly connected to the lower connection terminals of the bus module.

Re-establish the ground connection when the connection to the power jumper contacts is disrupted!

Should the ground conductor connection of the power jumper contacts within the node become disrupted, e. g. due to a 4-channel bus terminal, the ground connection will need to be re-established.

The ring feeding of the grounding potential will increase the system safety. When one bus module is removed from the group, the grounding connection will remain intact. The ring feeding method has the grounding conductor connected to the beginning and end of each potential group.

Figure 1-6: Ring-feeding

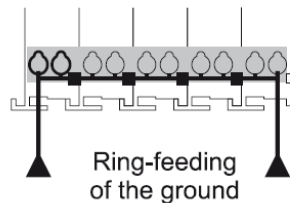

Observe grounding protection regulations!

You must observe the regulations relating to the place of assembly as well as the national regulations for maintenance and inspection of the grounding protection.

1.4 Shielding (Screening)

1.4.1 General

The shielding of the data and signal conductors reduces electromagnetic interferences thereby increasing the signal quality. Measurement errors, data transmission errors and even disturbances caused by overvoltage can be avoided.

Lay the shielding throughout the entrance and over a wide area!

Constant shielding is absolutely required in order to ensure the technical specifications in terms of the measurement accuracy.

The cable shield should be potential. With this, incoming disturbances can be easily diverted.

You should place shielding over the entrance of the cabinet or housing in order to already repel disturbances at the entrance.

Lay high-voltage cables separately!

Separate the data and signal conductors from all high-voltage cables.

1.4.2 Bus Conductors

The shielding of the bus conductor is described in the relevant assembly guidelines and standards of the bus system.

1.4.3 Signal Conductors

Bus modules for most analog signals along with many of the interface bus modules include a connection for the shield.

Improve shield performance by placing the shield over a large area!

For a better shield performance, you should place the shield previously over a large area.

2 Fieldbus Coupler

The 750-352 fieldbus coupler connects the I/O Module System with the infrared device via Ethernet.

Equipped with two RJ-45 ports, which both work as 2-channel switches, the fieldbus coupler enables easy and cost-effective cabling.

With the DIP switch the last byte of the IP address, as well as the assignment of the IP address (BootP, firm setting) can be given.

In the fieldbus coupler, all input signals from the sensors are combined. After connecting the fieldbus coupler, the fieldbus coupler determines which I/O modules are on the node and creates a local process image from these. The data of the analog modules is mapped first into the process image. The modules are mapped in the order of their physical position after the coupler. The digital modules are then mapped after the analog ones in the process image.

Process data linking is performed in the PC software for the infrared device automatically.

2.1 View

The view below shows the different parts of the device:

- The fieldbus connection is within the lower range on the left side.
- Over the fieldbus connection is a power supply unit for the system supply.
- LEDs for bus communication, error messages and diagnostics are within the upper range on the right side.
- Downright the service interface is to be found.

Figure 2-1: View Ethernet TCP/IP Fieldbus Coupler

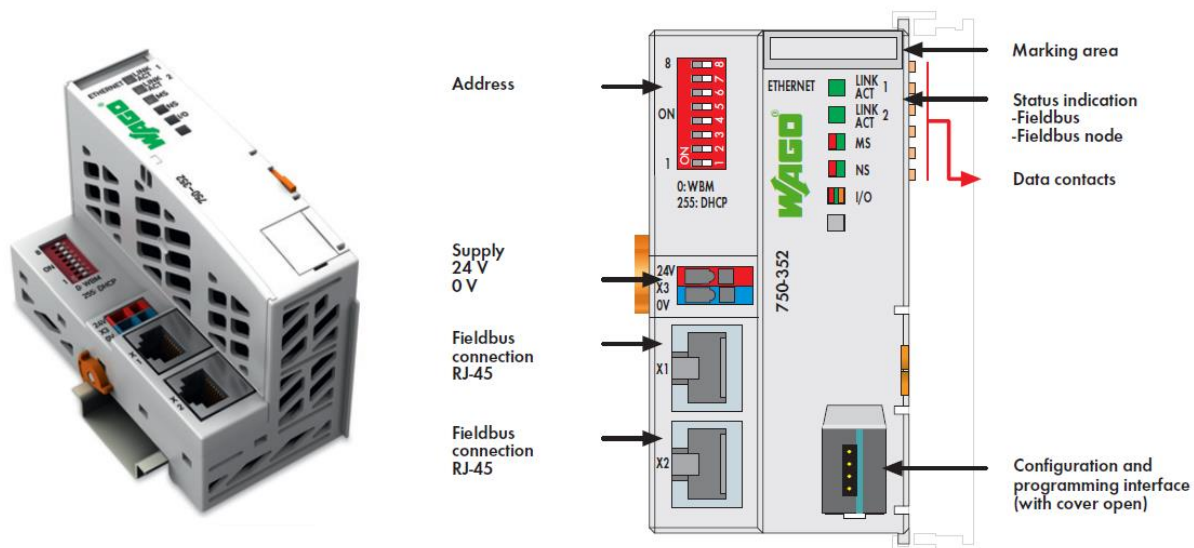

2.2 Connectors

2.2.1 Device Supply

The device is powered via terminal blocks with CAGE CLAMP® connections. The device supply generates the necessary voltage to power the electronics of the device and the internal electronics of the connected I/O modules. The fieldbus interface is galvanically separated from the electrical potential of the device via the transducer.

Figure 2-2: Device Supply

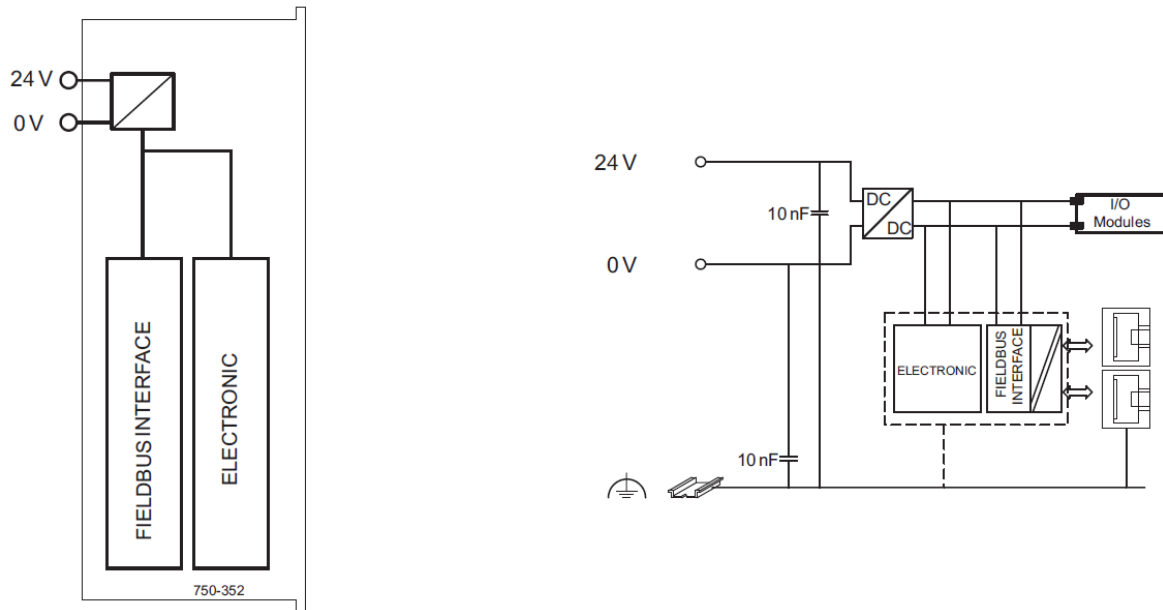

2.2.2 Fieldbus Connection

The connection to the fieldbus is made via two RJ-45 plugs, which are connected to the fieldbus controller via an integrated switch.

The integrated switch works in store-and-forward operation and for each port, supports the transmission speeds 10/100 Mbit as well as the transmission modes full and half-duplex and auto-negotiation. The wiring of these plugs corresponds to the specifications for 100BaseTX, which prescribes a category 5 twisted pair cable as the connecting cable. Cable types S-UTP (Screened Unshielded Twisted Pair) and STP (Shielded Twisted Pair) with a maximum segment length of 100 m (328 ft) can be used. The RJ-45 socket is physically lower, allowing the coupler to fit in an 80 mm (3.1 in) high enclosure once connected.

Table 2-1: RJ-45 Connector and RJ-45 Connector Configuration

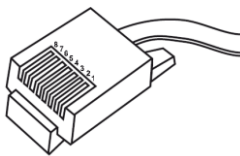
View	Pin	Signal	Meaning
	1	TD +	Transmit Data +
	2	TD -	Transmit Data -
	3	RD +	Receive Data +
	4		n.a.
	5		n.a.
	6	RD -	Receive Data -
	7		n.a.
	8		n.a.

Not for use in telecommunication circuits!

Only use devices equipped with ETHERNET or RJ-45 connectors in LANs. Never connect these devices with telecommunication networks.

2.3 Display Elements

2.3.1 Indicators

The operating condition of the coupler or the node is displayed with the help of illuminated indicators in the form of light-emitting diodes (LEDs). The LED information is routed to the top of the case by light fibers. In some cases, these are multi-colored (red/green or red/green/orange).

Figure 2-3: Display Elements

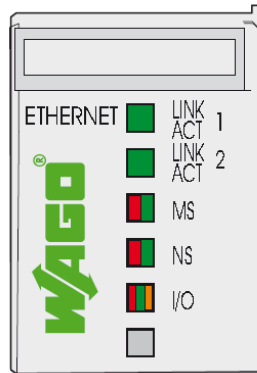

For the diagnostics of the different ranges fieldbus and node, the LED's can be divided into groups:

Table 2-2: Display Elements Fieldbus Status

LED	Color	Meaning
LINK ACT 1	green	indicates a connection to the physical network at port 1
LINK ACT 2	green	indicates a connection to the physical network at port 2
MS	red/green	indicates the status of the node (Module Status)
NS	red/green	indicates the status of the node (Network Status)

Table 2-3: Display Elements Node Status

LED	Color	Meaning
I/O	red/green/orange	indicates the operation of the node and signals via a blink code faults encountered

2.3.2 Fieldbus Status

The health of the ETHERNET fieldbus is signaled through the top LED group (“LINK ACT 1”, “LINK ACT 2”, “MS”, and “NS”). The two-colored LED’s “MS” (module status) and “NS” (network status) are solely used by the Ethernet/IP protocol. These two LED’s conform to the Ethernet/IP specifications.

Table 2-4: Fieldbus Diagnostics

LED Status	Meaning	Solution
LINK ACT 1, 2		
green	The fieldbus node is connected to the physical network.	
green flashing	The fieldbus node sends and receives Ethernet telegrams	
off	The fieldbus node is not connected to the physical network.	Check the fieldbus cable.
MS		
green	Normal operation	
green flashing	The system is not yet configured.	
red	The system indicates a not remediable error.	Restart the device by turning the power supply off and on again. If the error still exists, please contact the technical support.
red/green flashing	Self-test	
off	No system supply voltage	Check the supply voltage
NS		
green	Connection is developed (also connection to the Message rout applies)	
green flashing	No connection.	
red	The system indicates a double IP address in the network	Use an IP address that is not used yet.
red flashing	Connection announced a Timeout, where the controller functions as target.	Restart the device by turning the power supply off and on again. Develop a new connection.
red/green flashing	Self-test	
off	No IP address is assigned to the system.	Assign to the system an IP address for example by BootP or DHCP.

2.3.3 Node Status

The communication status between fieldbus coupler/controller is indicated by the “I/O” LED.

Table 2-5: Node Status Diagnostics

LED Status	Meaning	Solution
I/O		
green	The fieldbus node is operating correctly.	
orange flashing	The internal data bus is initialized, 1-2 s of rapid flashing indicate start-up.	
red	Controller hardware defect	Replace the fieldbus coupler/controller
red flashing	General internal bus error	Please contact the technical support.
red cyclical flashing	Up to three successive blinking sequences indicate internal data bus errors. There are short intervals between the sequences.	Please contact the technical support.
off	No data cycle on the internal bus.	The fieldbus coupler/controller supply is off.

Device boot-up occurs after turning on the power supply. The I/O LED is orange.

After a trouble-free start-up, the I/O LED is green.

In the event of an error, the I/O LED continues to blink red. Blink codes indicate detailed error messages. An error is indicated cyclically by up to 3 blinking sequences.

After elimination of the error, restart the node by turning the power supply of the device off and on again.

2.4 Address Selection Switch

The configuration of the IP address via the address selection switch takes place when you set the host ID (last digit of the IP address). The coding of the host ID is bit by bit and begins with address selection switch 1 for bit 0 (LSB) and ends with address selection switch 8 for bit 7 (MSB). The base address used depends on the IP address currently saved in the coupler.

With the original factory settings, the IP address is configured to the value 0.0.0.0 by default. In this case, the static base address 192.168.42.x is used.

Figure 2-4: Address Selection Switch



3 Assembly

3.1 Installation Position

Along with horizontal and vertical installation, all other installation positions are allowed. In the case of vertical assembly, an end stop has to be mounted as an additional safeguard against slipping.

3.2 Total Extension

The length of the module assembly (including one end module of 12 mm/0.47 in width) that can be connected to the fieldbus coupler is 780 mm (31 in). When assembled, the I/O modules have a maximum length of 768 mm (30 in).

Examples:

- 64 I/O modules of 12 mm (0.47 in) width can be connected to one coupler/controller.
- 32 I/O modules of 24 mm (0.94 in) width can be connected to one coupler/controller.

3.3 Assembly onto Carrier Rail

3.3.1 Carrier Rail Properties

All system components can be snapped directly onto a carrier rail in accordance with the European standard EN 50022 (DIN 35).

Do not use any third-party carrier rails without approval by WAGO!

The manufacturer supplies standardized carrier rails that are optimal for use with the I/O module system. If other carrier rails are used, then a technical inspection and approval of the rail by WAGO Kontakttechnik GmbH & Co. KG should take place.

Carrier rails have different mechanical and electrical properties. For the optimal system setup on a carrier rail, certain guidelines must be observed:

- The material must be non-corrosive.
- Most components have a contact to the carrier rail to ground electromagnetic disturbances. In order to avoid corrosion, this tin-plated carrier rail contact must not form a galvanic cell with the material of the carrier rail which generates a differential voltage above 0.5 V (saline solution of 0.3% at 20°C/68°F).
- The carrier rail must optimally support the EMC measures integrated into the system and the shielding of the bus module connections.
- A sufficiently stable carrier rail should be selected and, if necessary, several mounting points (every 20 cm/7.9 in) should be used in order to prevent bending and twisting (torsion).
- The geometry of the carrier rail must not be altered in order to secure the safe hold of the components. In particular, when shortening or mounting the carrier rail, it must not be crushed or bent.
- The base of the I/O components extends into the profile of the carrier rail. For carrier rails with a height of 7.5 mm (0.3 in), mounting points are to be riveted under the node in the carrier rail (slotted head captive screws or blind rivets).
- The medal springs on the bottom of the housing must have low-impedance contact with the DIN rail (wide contact surface is possible).

3.4 Spacing

The spacing between adjacent components, cable conduits, casing and frame sides must be maintained for the complete fieldbus node.

Figure 3-1: Spacing

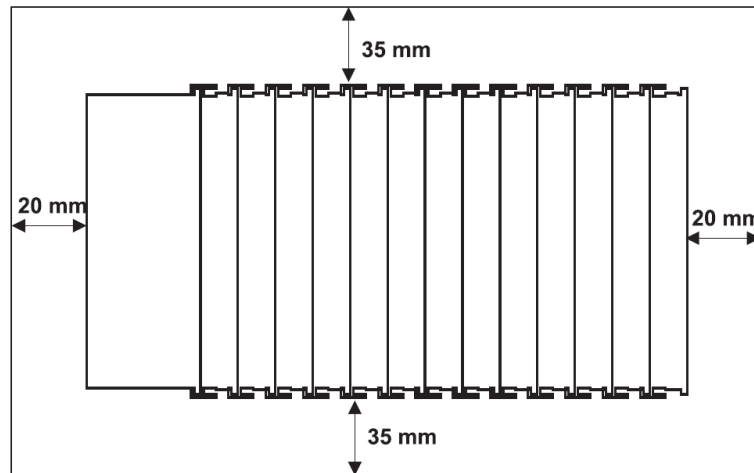

The spacing creates room for heat transfer, installation or wiring. The spacing to cable conduits also prevents conducted electromagnetic interferences from influencing the operation.

3.5 Assembly Sequence

All system components can be snapped directly on a carrier rail in accordance with the European standard EN 50022 (DIN 35).

The reliable positioning and connection is made using a tongue and groove system. Due to the automatic locking, the individual components are securely seated on the rail after installation.

Starting with the fieldbus coupler, the bus modules are assembled adjacent to each other according to the project design. Errors in the design of the node in terms of the potential groups (connection via the power contacts) are recognized, as the bus modules with power contacts (male contacts) cannot be linked to bus modules with fewer power contacts.



Risk of injury due to sharp-edged male contacts!

The male contacts are sharp-edged. Handle the module carefully to prevent injury.



Connect the I/O modules in the required order!

Never plug bus modules from the direction of the end terminal. A ground wire power contact, which is inserted into a terminal without contacts, e.g. a 4-channel digital input module, has a decreased air and creepage distance to the neighboring contact in the example DI4.

Assemble the I/O modules in rows only if the grooves are open!



Please take into consideration that some bus modules have no or only a few power jumper contacts. The design of some modules does not allow them to be physically assembled in rows, as the grooves for the male contacts are closed at the top.

Don't forget the bus end module!

Always plug a bus end module 750-600 onto the end of the fieldbus node to guarantee proper data transfer.

3.6 Inserting and Removing Devices



Use caution when interrupting the PE!

Make sure that people or equipment is not placed at risk when removing an I/O module and the associated PE interruption. To prevent interruptions, provide ring feeding of the ground conductor.



Perform work on devices only if the system is de-energized!

Working on devices when the system is energized can damage the devices. Therefore, turn off the power supply before working on the devices.

3.6.1 Inserting the Fieldbus Coupler

1. When replacing the fieldbus coupler for an already available fieldbus coupler, position the new fieldbus coupler/controller so that the tongue and groove joints to the subsequent I/O module are engaged.
2. Snap the fieldbus coupler/controller onto the carrier rail.
3. Use a screwdriver blade to turn the locking disc until the nose of the locking disc engages behind the carrier rail (see the following figure). This prevents the fieldbus coupler from canting on the carrier rail.

With the fieldbus coupler snapped in place, the electrical connections for the data contacts and power contacts (if any) to the possible subsequent I/O module are established.

Figure 3-2: Unlocking Lug

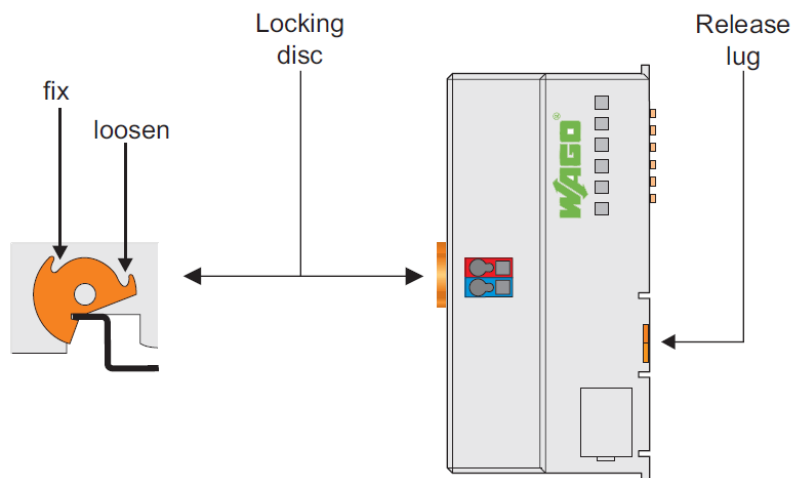

3.6.2 Removing the Fieldbus Coupler

1. Use a screwdriver blade to turn the locking disc until the nose of the locking disc no longer engages behind the carrier rail.
2. Remove the fieldbus coupler/controller from the assembly by pulling the release tab.

Electrical connections for data or power contacts to adjacent I/O modules are disconnected when removing the fieldbus coupler/controller.

3.6.3 Inserting I/O Module

1. Position the I/O module so that the tongue and groove joints to the fieldbus coupler or to the previous or possibly subsequent I/O module are engaged.

Figure 3-3: Insert I/O module



2. Press the I/O module into the assembly until the I/O module snaps into the carrier rail.

Figure 3-4 Snap the I/O module into place

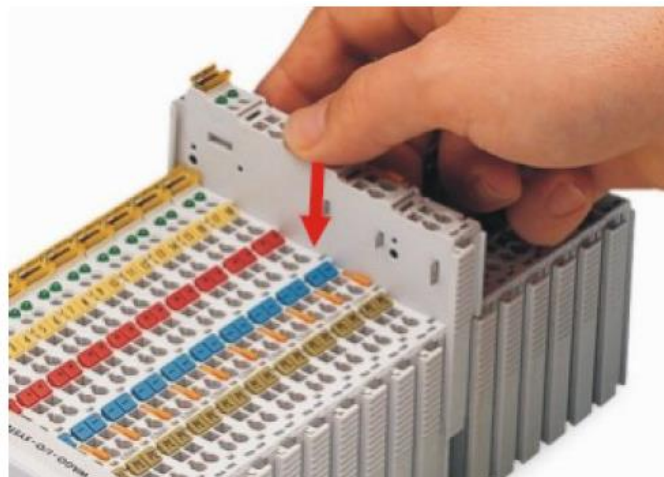

With the I/O module snapped in place, the electrical connections for the data contacts and power contacts (if any) to the fieldbus coupler or to the previous or possibly subsequent I/O module are established.

3.6.4 Removing the I/O Module

1. Remove the I/O module from the assembly by pulling the release tab.

Figure 3-5 Removing the I/O module

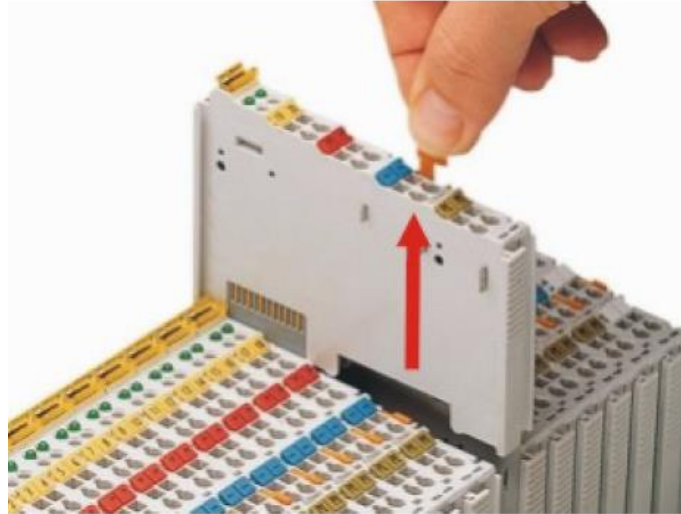

Electrical connections for data or power contacts are disconnected when removing the I/O module.

4 Connect Devices

4.1 Data Contacts / Internal Bus

Communication between the coupler/controller and the bus modules as well as the system supply of the bus modules is carried out via the internal bus. It is comprised of 6 data contacts, which are available as self-cleaning gold spring contacts.

Figure 4-1: Data Contacts



4.2 Power Contacts / Field Supply



Risk of injury due to sharp-edged male contacts!

The male contacts are sharp-edged. Handle the module carefully to prevent injury.

Self-cleaning power jumper contacts used to supply the field side are located on the right side of both couplers and some of the I/O modules. These contacts come as touch-proof spring contacts. As fitting counterparts the I/O modules have male contacts on the left side.

Figure 4-2: Example for the arrangement of power contacts

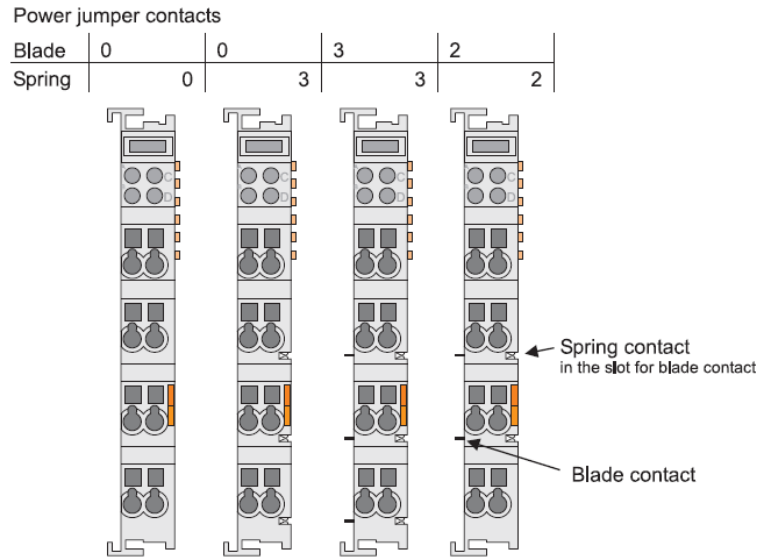

4.3 Connecting a conductor to the CAGE CLAMP®

The CAGE CLAMP® connection is appropriate for solid, stranded and finely stranded conductors.

Only connect one conductor to each CAGE CLAMP® connection!

Only one conductor may be connected to each CAGE CLAMP® connection. Do not connect more than one conductor at one single connection!

If more than one conductor must be routed to one connection, these must be connected in an up-circuit wiring assembly.

1. To open the CAGE CLAMP® insert the actuating tool into the opening above the connection.
2. Insert the conductor into the corresponding connection opening.
3. To close the CAGE CLAMP® simply remove the tool - the conductor is then clamped firmly in place.

Figure 4-3: Connecting a conductor to a CAGE CLAMP®

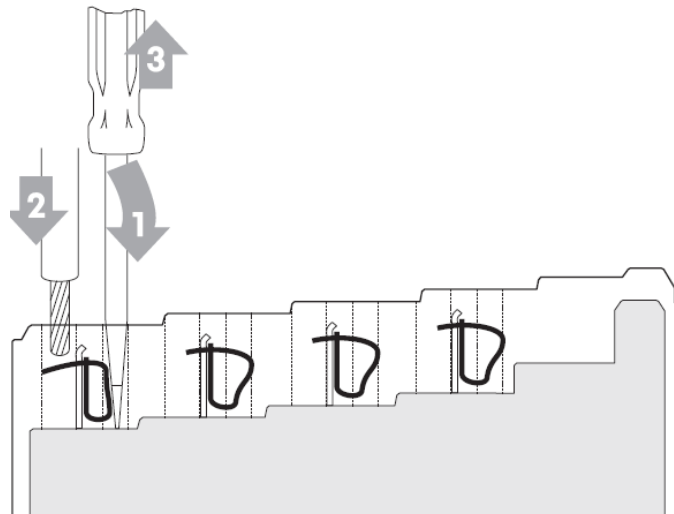

5 Commissioning

This chapter shows a step-by-step procedure for starting up exemplarily a fieldbus node.

Good example!

This description is just an example and only serves to describe the procedure for a local start-up of a single fieldbus node with a non-networked computer under Windows.

Two work steps are required for start-up. The description of these work steps can be found in the corresponding following sections.

- Connecting client PC and fieldbus nodes
- Assigning the IP address to the fieldbus node

The IP address must occur in the network only once!

For error-free network communication, note that the assigned IP address must occur only once in the network! In the event of an error, the error message "IP address configuration error" (error code 6 - error argument 6) is indicated by 'I/O' LED at the next power-on.

There are various ways to assign the IP address. The various options are described in the following sections individually.

5.1 Connecting Client PC and Fieldbus Nodes

1. Mount the fieldbus node on the TS 35 carrier rail. Follow the assembly instructions found see section 3 [Assembly](#), page 22.
2. Connect the 24V power supply to the supply terminals.
3. Connect the PC's Ethernet interface to the fieldbus coupler's Ethernet interface.
4. Turn the operating voltage on.

The fieldbus coupler is initialized. The coupler determines the I/O module configuration and creates a process image. During start-up, the I/O LED (red) flashes. If the I/O LED lights up green after a brief period, the fieldbus coupler is operational. If an error has occurred during startup, a fault code is flashed on the I/O LED.

5.2 Allocating the IP Address to the Fieldbus Node

- Assigning IP Address via BootP server
- Use address selection switch (DIP switch) to assign IP address (manually).

5.2.1 Assigning the IP Address with a BootP Server

A BootP server can be used to assign a fixed IP address. The BootP server capability is managed by the PC software of the infrared device and is set as the default address mode.

Set the address selection switch to 0!

Set the address selection switch to 0 to disable the DIP switch and to enable the software configuration via BootP. Restart the fieldbus node after adjusting the address selection switch to apply the configuration changes.

To assign a fixed IP address via a BootP server, the MAC ID must be known to the PC software. The MAC ID is applied to the back of the fieldbus coupler or on the selfadhesive peel-off strip on the side of the fieldbus coupler. MAC ID of the fieldbus coupler: `00:30:DE:__:__:__`

5.2.2 Assigning IP Address via Address Selection Switch

Use the address selection switch to set the host ID, i.e., the last byte ("X") of the IP address saved in the fieldbus coupler with values between 1 and 254 binary coded.

Example:

IP address saved in the fieldbus coupler:	192.168.42.20
Set DIP switch value:	50 (binary coded: 00110010)
Resulting IP address:	192.168.42.50

Host ID 1 - 254 via address selection switch freely adjustable!

Use the address selection switch to set the last byte ("X") of the IP address to a value between 1 and 254. The DIP switch is then enabled and the IP address is composed of the base address stored in the fieldbus coupler and the host ID set on the DIP switch.

Address selection switch values 0 and 255 are predefined, address selection switch disabled!

If you use the address selection switch to set the value 0 or 255, the address selection switch is disabled and the setting configured in the fieldbus coupler is used. With the value 0, the settings of the BootP server apply. If you set the value 255, the configuration via DHCP would be activated but is not supported with the PC software.

The base address used consists of the first three bytes of the IP address. This always depends on the IP address currently saved in the fieldbus coupler.

If there is still no static IP address in the fieldbus coupler, the default value **192.168.42.X** defined by the firmware as the base address is used when setting the DIP switch to 1 - 254. The address selection switch setting then overwrites the value of the host ID "X".

1. To configure the IP address via the address selection switch by setting the host ID (last position of the IP address) to a value that does not equal 0/255, first convert the host ID to the binary representation. For example, host ID 50 results in a binary code of 00110010.
2. Set the bits in sequence using the 8 address switches. Start with address switch 1 to set bit 0 (LSB) and end with address switch 8 for bit 7 (MSB).

Figure 5-1: Address selection switch



3. Restart the fieldbus coupler after adjusting the address selection switch to apply the configuration changes.

5.3 Restoring Factory Settings

To restore the factory settings, proceed as follows:

1. Switch off the supply voltage of the fieldbus coupler.
2. Connect the communication cable 750-920 to the configuration interface of the fieldbus coupler and to a vacant serial port on your computer.
3. Switch on the supply voltage of the fieldbus coupler.
4. Start the WAGO-ETHERNET-Settings program.
5. In the top menu bar, select <Default> and click [Yes] to confirm.

A restart of the fieldbus node is implemented automatically. The start takes place with the default settings.

6 System Components

6.1 Fieldbus Coupler 750-352

Figure 6-1: Fieldbus Coupler

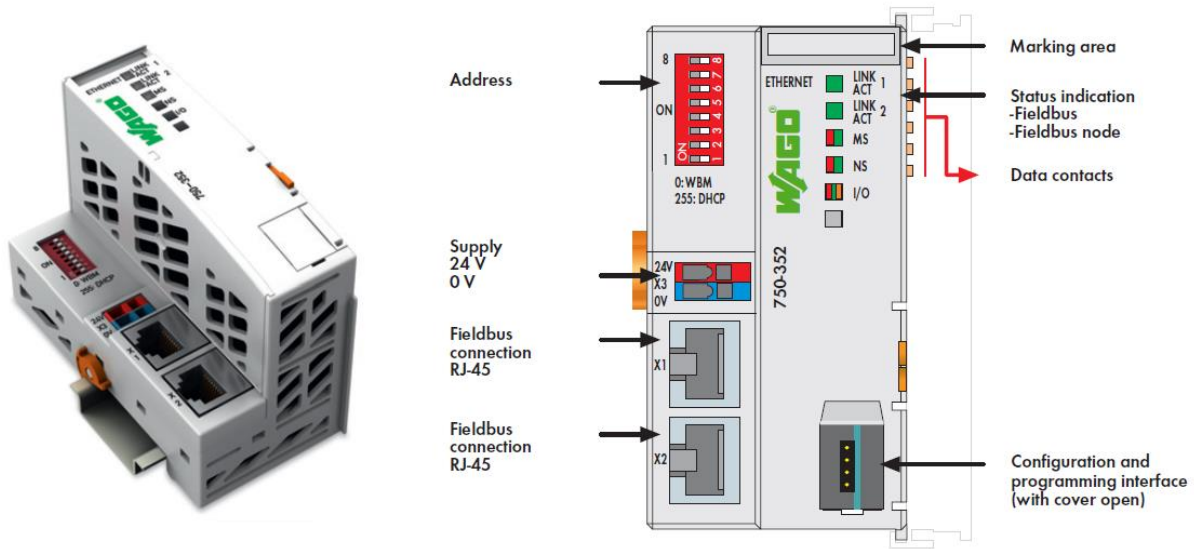
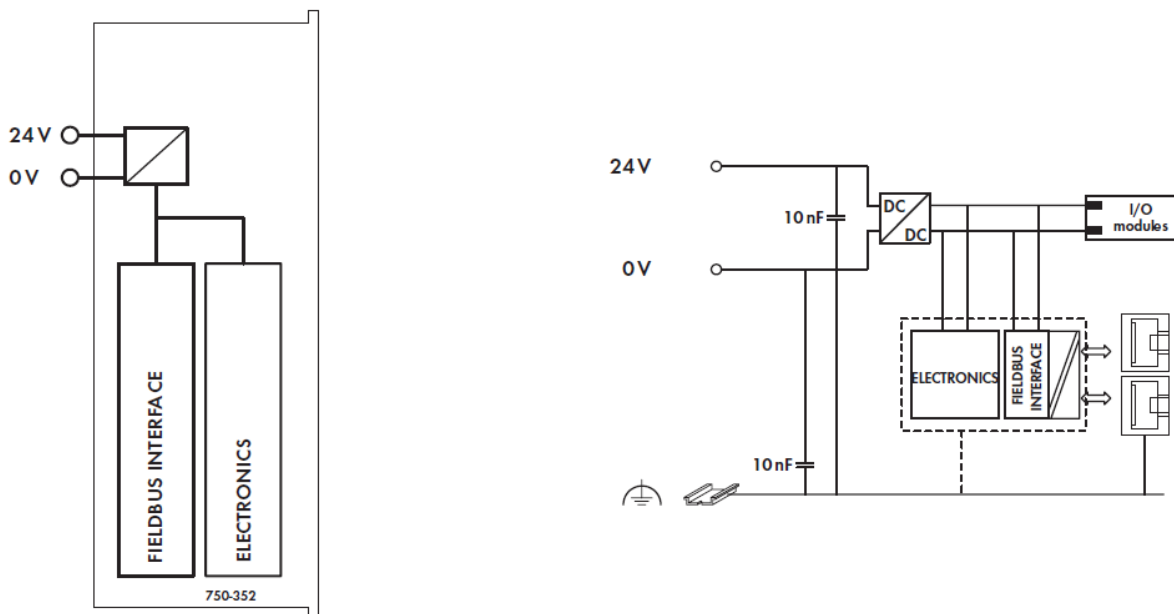

Figure 6-2: Principle Circuit



I/O Module System

Users Manual, Rev. 1.1, May 2018

Type	750-352
Fieldbus coupler connection	2 x RJ-45
Baud rate	10/100 Mbit/s
Length of fieldbus segment	max 100 m (328 ft)
Number of I/O modules	64
Degree of protection	IP 20
Voltage supply	24 VDC (-25 % ... +30 %)
Input current	max. 280 mA at 24 V
Total current for I/O modules	700 mA at 5 V
Isolation	500 V system/supply
Operating temperature range	0 to 55°C (32 to 131°F)
Wire connection	CAGE CLAMP®
Cross section	0.08 mm ² ... 1.5 mm ² (AWG 28-16)
Relative humidity	95% (without condensation)
Special conditions	Ensure that additional measures for components are taken, which are used in an environment involving: <ul style="list-style-type: none">– dust, caustic vapors or gases– ionization radiation
Vibration resistance	acc. to IEC 60068-2-6
Shock resistance	acc. to IEC 60068-2-27
Dimensions W x H x L	50 mm x 65 mm x 97 mm (1.97 in x 2.56 in x 3.82 in) Height from upper-edge of DIN 35 rail

6.1 Relay Output Module 750-513

Figure 6-3: Relay Output Module

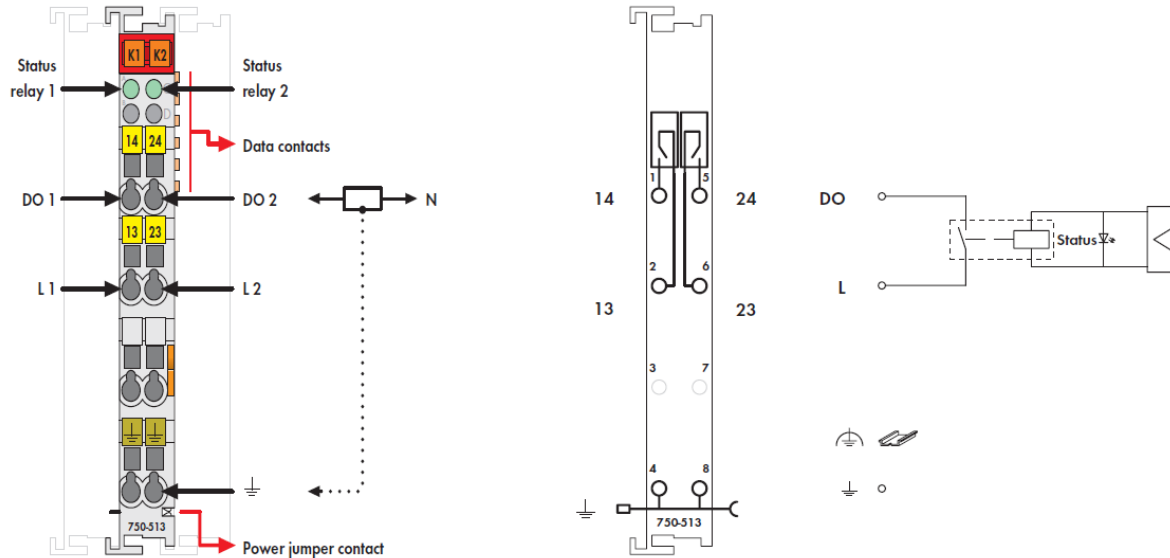

Type	750-513
No. of outputs	2 closing contacts (potential free)
Max. current consumption (internal)	100 mA
Max. switching voltage	250 VAC / 30 VDC
Switching power	500 VA / 60 W (resistive load) ($\cos \phi$ max. = 0.4; L/R max = 7 ms)
Max. switching current	2 A AC / DC
Max. switching frequency	30/min (at nominal load)
Pull-in time (max.)	10 ms
Isolation	1.5 kV eff. (field/system), 2.5 kV rated surge voltage; Overvoltage category III
Wire connection	CAGE CLAMP®
Cross sections	0.08 mm ² ... 2.5 mm ² / AWG 28 ... 14
Width	12 mm (0.47 in)

6.2 Relay Output Module 750-517

Figure 6-4: Relay Output Module

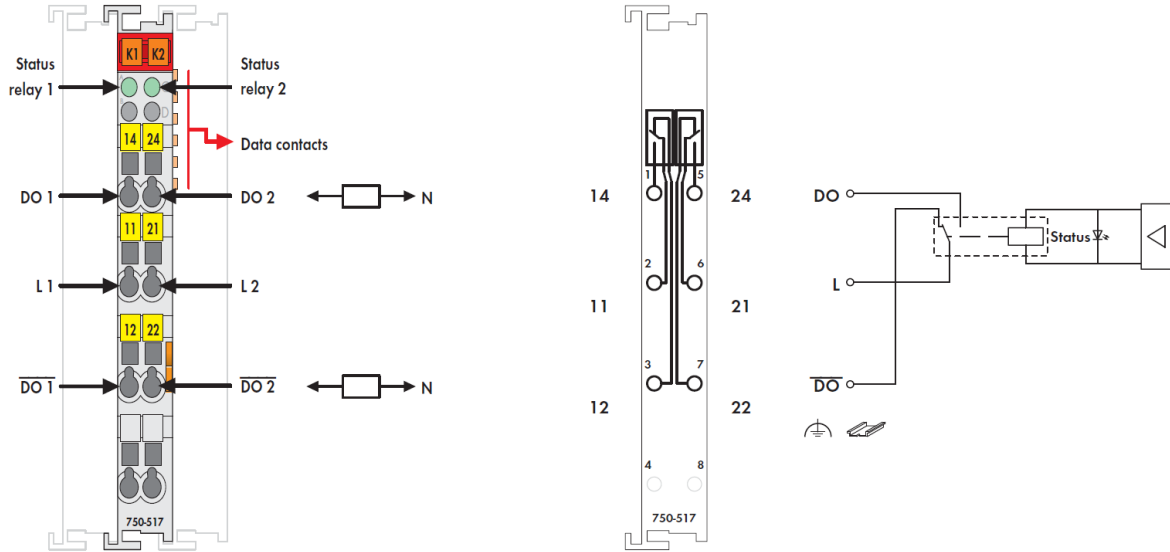

Type	750-517
No. of outputs	2 changeover contacts (potential free)
Max. current consumption (internal)	90 mA
Max. switching voltage	250 VAC / 300 VDC
Min. switching current	100 mA / 12 VDC
Max. switching current	1 A AC, 1 A at 40 VDC, 0.15 A at 300 VDC
Max. switching frequency	6 per min (at nominal load)
Pull-in time (max.)	8 ms
Isolation	1.5 kV eff. (field/system), 2.5 kV rated surge voltage
Wire connection	CAGE CLAMP®
Cross sections	0.08 mm ² ... 2.5 mm ² / AWG 28 ... 14
Width	12 mm (0.47 in)

6.3 Digital Output Module 750-1504

Figure 6-5: Digital Output Module

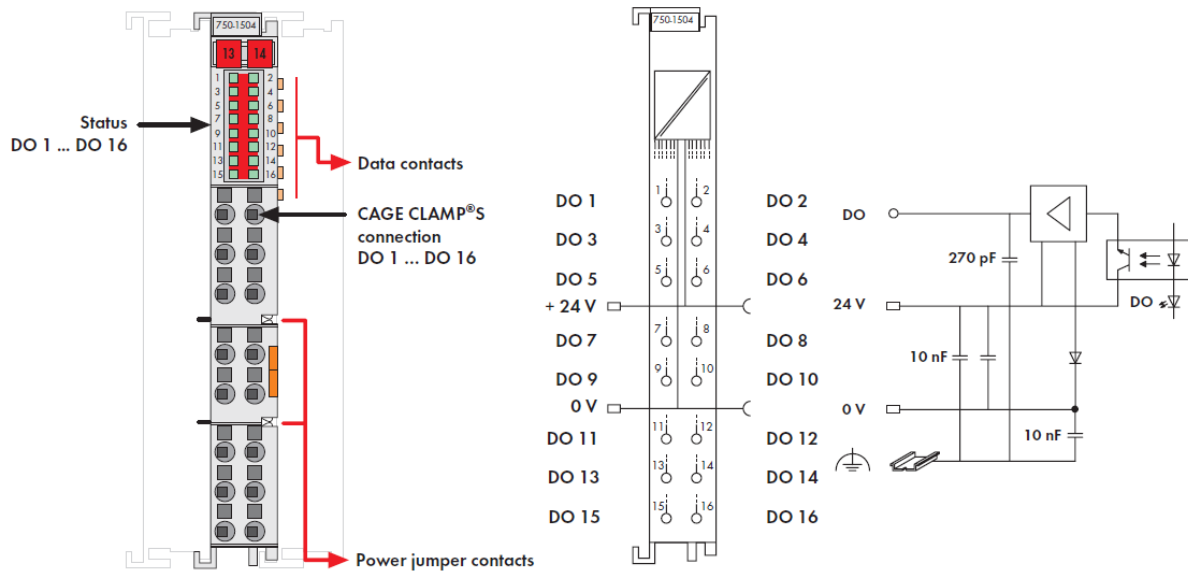

The digital output module provides 16 channels. A green LED indicates the switched status of each channel. An optocoupler provides electrical isolation between the bus and the field side.

Type	750-1504
No. of outputs	16
Max. current consumption (internal)	40 mA
Voltage via power jumper contacts	24 V DC (-25 % ... +30 %)
Type of load	resistive, inductive, lamps
Max. switching frequency	1 kHz
Output current (max.)	0.5 A, short-circuit protected
Current consumption typ. (field side)	29 mA
Isolation	500 V system/supply
Wire connection	CAGE CLAMP®
Cross sections	0.08 mm ² ... 1.5 mm ² / AWG 28 ... 16
Width	12 mm (0.47 in)

6.4 Analog Output Module 750-562

Figure 6-6: Analog Output Module, V

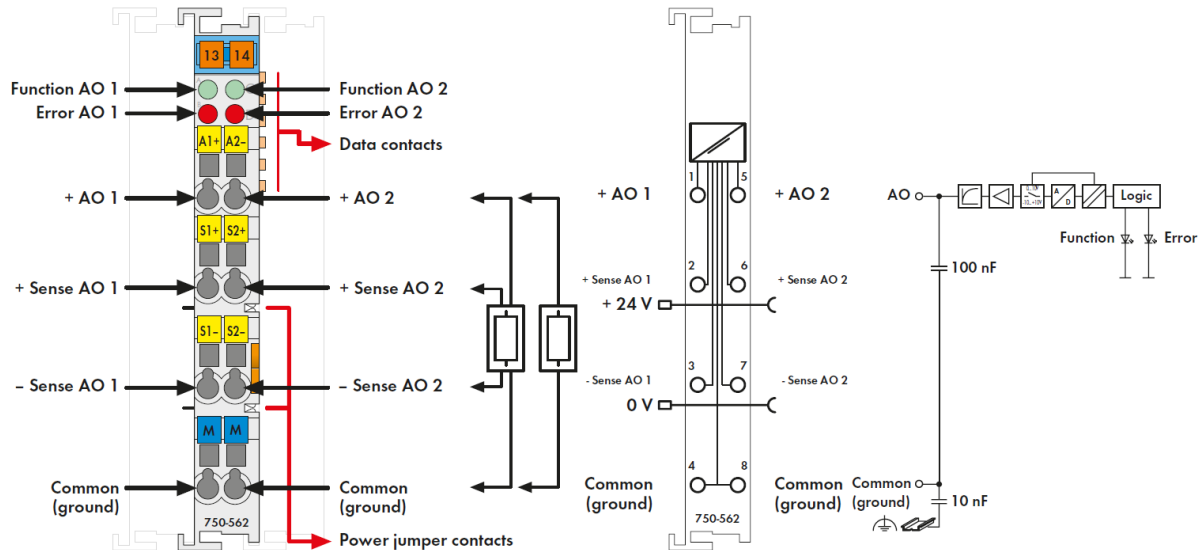

The analog output module 750-562 generates output voltages ranging from 0–10 V for the field. The output range is preset by the manufacturer but can be changed later via WAGO-I/O-CHECK. The module has two short circuit-proof output channels and enables direct connection of two 2-line actuators on the connections AO 1 and ground or AO 2 and ground. Signals are output via AO 1 or AO 2. In addition, the sense lines from 4-line actuators can be connected to the connections Sense AO1 and +Sense AO1 or Sense AO2 and +SenseAO2. Both output channels have a common ground potential. The output signal is electrically isolated.

Type	750-562
Signal voltage	0 V ... 10 V
Current consumption (internal)	80 – 170 mA
Load impedance	> 5 k Ω
Resolution	16 bits
Conversion time (typ.)	5 ms
Measuring error 25°C (77°F)	< \pm 0.05 % of the scale end value
Isolation	500 V system/supply
Wire connection	CAGE CLAMP®
Cross sections	0.08 mm ² ... 2.5 mm ² / AWG 28 ... 14
Width	12 mm (0.47 in)

6.5 Analog Output Module 750-563

Figure 6-7: Analog Output Module, mA

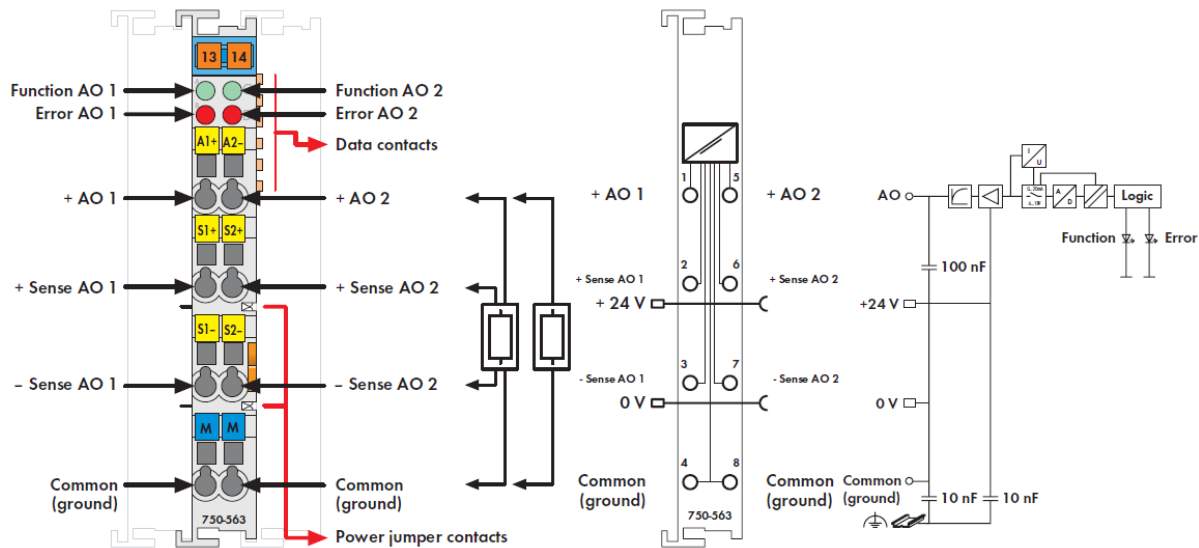

The analog output module generates output currents ranging from 0/4 to 20 mA for the field. Output ranges are preset by the manufacturer but can be changed later via WAGO-I/O-CHECK software. The module has two short circuit-proof output channels and enables direct connection of two 2-line actuators on the connections AO 1 and ground or AO2 and ground. Signals are output via AO 1 or AO 2. In addition, the sense lines from 4-line actuators can be connected to the connections Sense AO1 and +Sense AO1 or Sense AO2 and +Sense AO2. Both output channels have a common ground potential. The output signal is electrically isolated.

Type	750-563
No. of outputs	2
Output current	0/4 mA ... 20 mA
Current consumption (internal)	80 – 110 mA
Load impedance	< 500 Ω
Resolution	16 bits
Conversion time (typ.)	5 ms
Measuring error 25°C (77°F)	< ± 0.05 % of the scale end value
Isolation	500 V system/supply
Wire connection	CAGE CLAMP®
Cross sections	0.08 mm ² ... 2.5 mm ² / AWG 28 ... 14
Width	12 mm (0.47 in)

Note

It is strongly recommended to use a [Passive Isolator 857-452](#) for each analog output module 750-563.

6.6 Passive Isolator 857-452

Figure 6-8: Passive Isolator

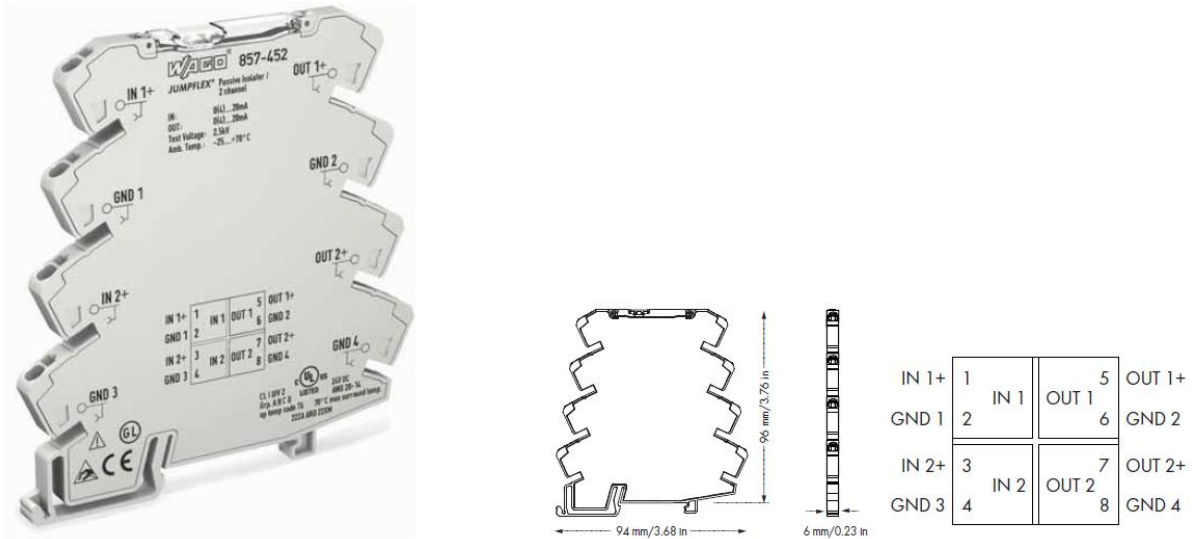

The 2-channel passive isolator filters and electrically isolates 0(4)–20 mA analog standard signals, while drawing power for signal transmission from the input circuit. The connected sensor supplies the passive isolator with the required power, while powering the connected load.

Characteristics:

- No additional supply voltage required
- Safe 3-way isolation with 2.5 kV test voltage to EN 61140

Type	857-452
No. of channels	2
Input signal	0(4) ... 20 mA
Output signal	0(4) ... 20 mA
Load impedance	≤ 600 Ω
Wire connection	CAGE CLAMP®
Cross sections	0.08 mm ² ... 2.5 mm ² / AWG 28 ... 14
Dimensions W x H x L	6 mm x 96 mm x 94 mm (0.24 in x 3.78 in x 3.7 in)

6.7 Digital Input Module 750-1406

Figure 6-9: Digital Input Module

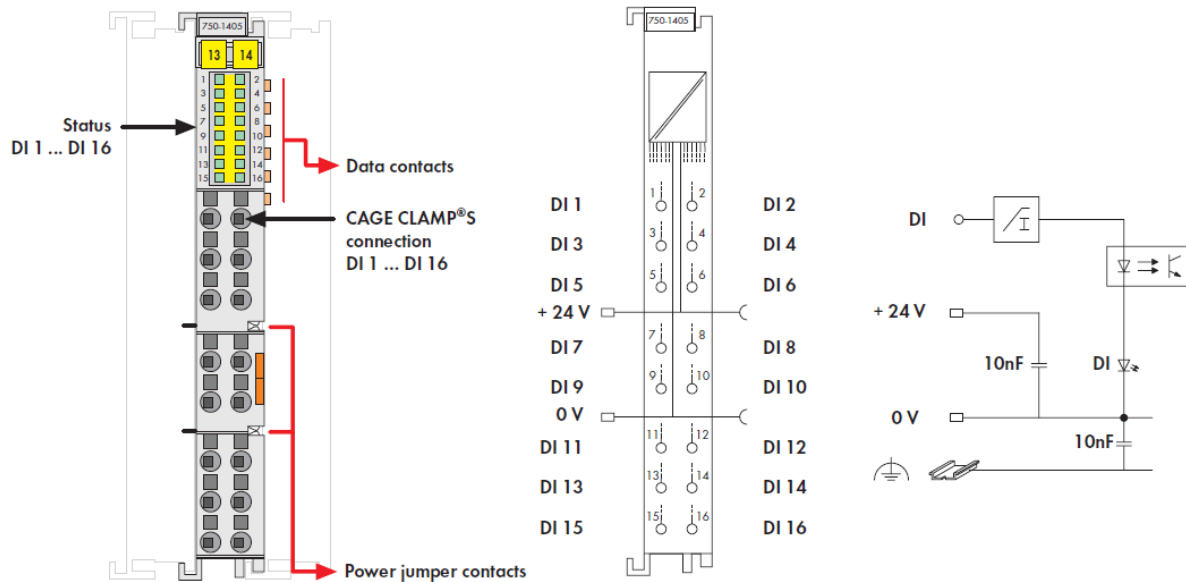

The digital input module provides 16 channels. A green LED indicates the switched status of each channel. An optocoupler provides electrical isolation between the bus and the field side.

Type	750-1406
No. of inputs	16
Max. current consumption (internal)	25 mA
Signal voltage (0)	-3 V ... +5 V DC
Signal voltage (1)	+15 V ... +30 V DC
Isolation	500 V system/supply
Wire connection	CAGE CLAMP®
Cross sections	0.08 mm ² ... 1.5 mm ² / AWG 28 ... 16
Width	12 mm (0.47 in)

6.8 Supply Module 750-602

Figure 6-10: Supply Module

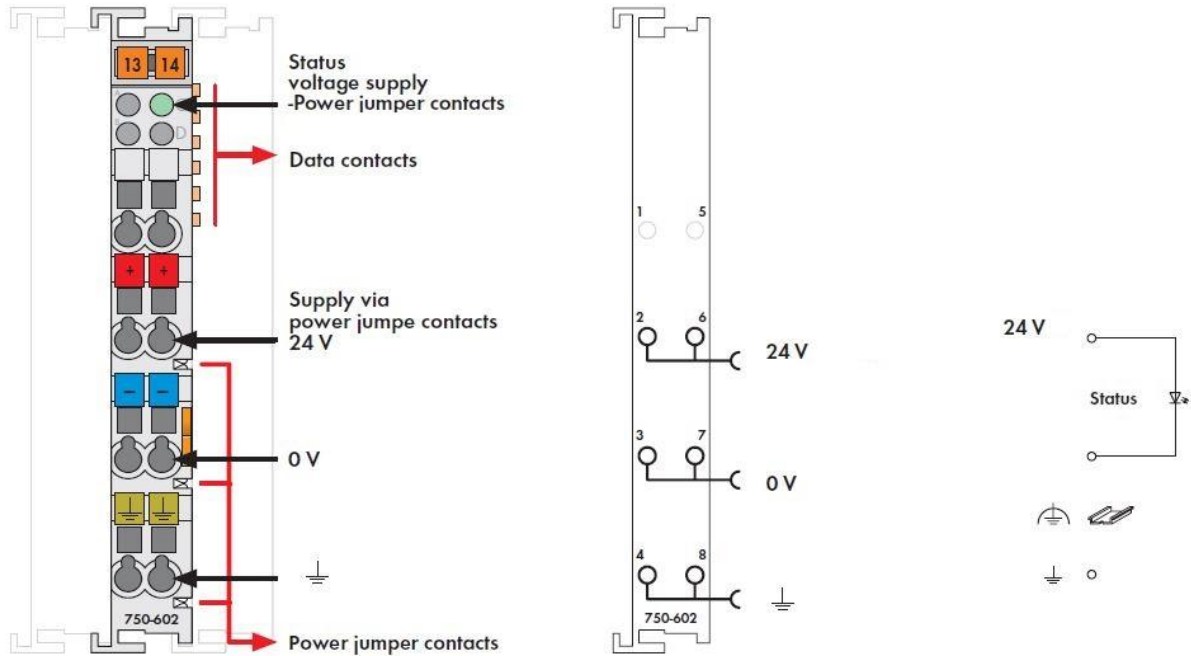

The supply module provides the I/O modules with the corresponding supply potential. The maximum current at the supply module is 10 A. When configuring the system, it must be ensured that this total current is not exceeded. Should higher currents be necessary, intermediate supply modules must be added in the assembly.

Type	750-602, passive
Voltage via power jumper contacts	max. 24 V DC
Current via power jumper contacts	max. 10 A DC
Wire connection	CAGE CLAMP®
Cross sections	0.08 mm ² ... 2.5 mm ² / AWG 28 ... 14
Width	12 mm (0.47 in)

6.9 End Module 750-600

Figure 6-11: End Module

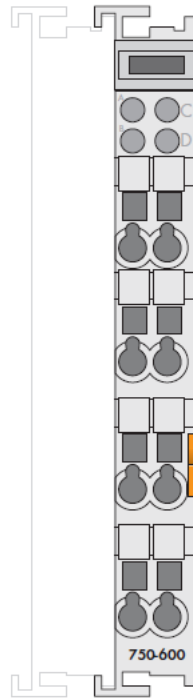

After the fieldbus node is assembled with the correct bus coupler and I/O modules, the end module is snapped onto the assembly. It completes the internal data circuit and ensures correct data flow.

Type	750-600
Width	12 mm (0.47 in)

6.10 Power Supply 787-1002

Figure 6-12: Power Supply Module

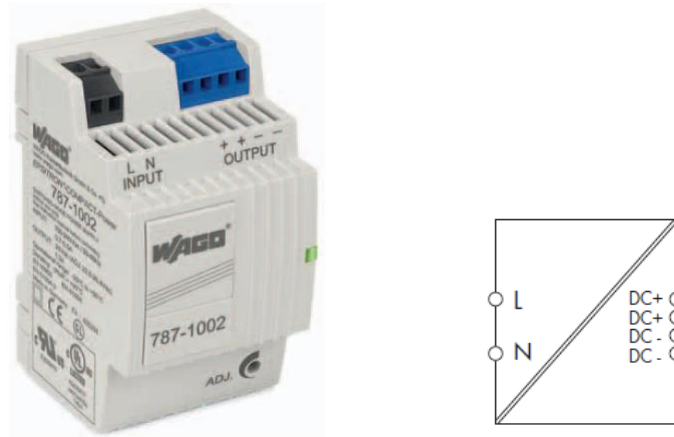

The switched mode power supply provides 24 VDC / 1.3 A. The output voltage is electrically isolated. Operation is indicated with a green LED.

Type	787-1002
Nominal input voltage	100 ... 240 VAC
Input voltage range	85 ... 264 VAC; 120 ... 373 VDC
Frequency	44 ... 66 Hz
Input current	0.7 A at 110 VAC / 0.5 A at 230 VAC
Nominal output voltage	24 VDC
Output voltage range	22.8 ... 26.4 VDC adjustable
Output current	1.3 A at 24 VDC max. 0.9 A in any mounting position
Internal fuse	T 2 A / 250 V
External fuse	Circuit breakers 10 A, 16 A characteristic: B or C
Operating temperature range	-25 to 60°C (-13 to 140°F)
Protection class	Prepared for class II equipment
Degree of protection	IP20 (acc. to EN 60529)
Short circuit protection	yes
Wire connection	WAGO 740 Series
Cross sections	0.08 mm ² ... 2.5 mm ² / AWG 28 ... 12
Type of mounting	DIN-rail mount (EN 60715)
Standards / Specifications	EN 60950, EN 61204-3, UL 60950, UL 508, GL
Dimensions W x H x L	54 mm x 89 mm x 59 mm (2.13 in x 3.5 in x 2.32 in) Height from upper-edge of DIN 35 rail

7 Application Examples

The following scenarios show application examples for the interconnection of different I/O modules with the fieldbus coupler.

Note

No matter which I/O modules are used at the beginning (left) is always the fieldbus coupler and at the end (right) is the end module as a termination!

7.1 Example 1: Relays

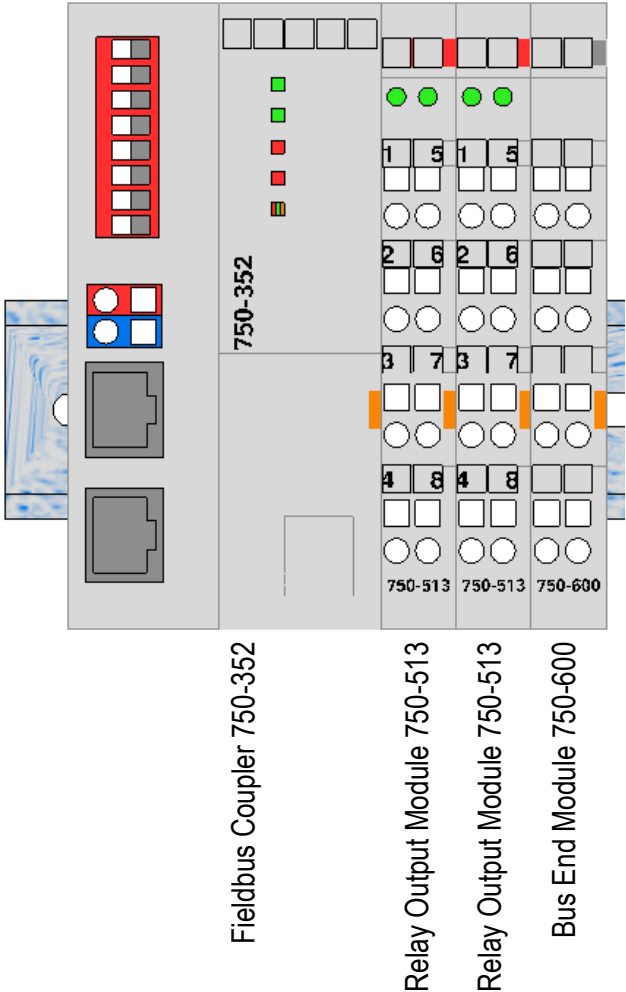

7.2 Example 2: Analog Out

Note

With analog and digital output modules a supply module 750-602 is always to be employed left of the first analog or digital output module!

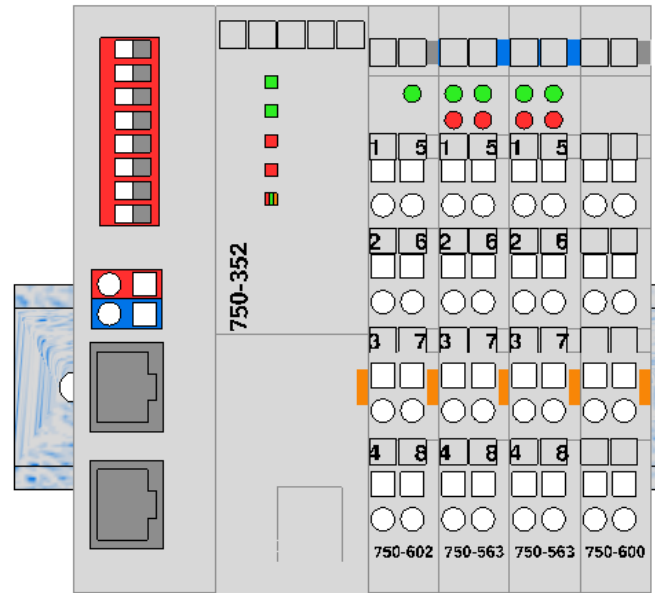

Fieldbus Coupler 750-352

Supply Module 750-602

Analog Out Module 750-563

Analog Out Module 750-563

Bus End Module 750-600

7.3 Example 3: Relays, Analog Out, Digital Out

Note

With analog and digital output modules a supply module 750-602 is always to be employed left of the first analog or digital output module!

If a relay module is in the installation, the supply module is always to use right from the relay module!

