



# Operating Manual for Universal Centrifuge Z 306



<b>+1. PRODUCT DESCRIPTION .....</b>	<b>1</b>
1.1 Safety Instructions .....	1
1.2 Intended Purpose .....	1
1.3 Brief Description.....	1
1.4 Delivery Package .....	1
1.5 Installation of the Centrifuge .....	2
1.5.1 Unpacking the Centrifuge .....	2
1.5.2 Space Requirements .....	2
1.5.3 Installation .....	2
1.6 Operating and Display Elements.....	3
1.6.1 LCD-Display .....	4
1.7 Signs and Indications of the Centrifuge .....	5
1.7.1 General.....	5
1.7.2 Product Nameplate (Example) .....	5
1.7.3 Warning and Information Signs .....	6
1.7.4 Danger, Precautions and Warranty .....	6
1.7.5 Following Rules Must Strictly be Adhered To:.....	7
1.7.6 Warranty.....	7
1.7.7 Basic Adjustments .....	9
1.7.8 Access to Mode: "Operating Data" .....	9
1.7.9 Sound Signal Turn On / Off .....	10
1.7.10 Volume Pre-Selection of Sound Signal .....	10
1.7.11 Song Selection - End of Run.....	11
1.7.12 Keyboard Sound Turn On / Off .....	11
1.7.13 Retrieving Operating Data (operated by skilled personnel or service engineer only!).....	12
<b>2. OPERATION .....</b>	<b>13</b>
2.1 Mounting and Loading the Angle Rotor .....	13
2.1.1 Installation of Rotors.....	13
2.1.2 Loading Angle Rotors.....	13
2.1.3 Loading Swing Out Rotors.....	14
2.1.4 Loading and Overloading of Rotors .....	14
2.1.5 Removing the Rotor .....	15
2.2 Lid .....	16
2.2.1 Lid Release .....	16
2.2.2 Lid Lock.....	16
2.3 Pre-Selection.....	17
2.3.1 Pre-Selection of Speed / RCF-Value .....	17
2.3.2 Pre-Selection of Running Time.....	17
2.3.3 Pre-Selection of Brake Intensity and Acceleration.....	18
2.4 Radius Correction.....	19
2.5 Program .....	19
2.5.1 Storage of Programs .....	19
2.5.2 Recall of Stored Programs .....	20

2.5.3	Leaving Program Mode .....	20
<b>2.6</b>	<b>Starting and Stopping the Centrifuge .....</b>	<b>21</b>
2.6.1	Starting the Centrifuge.....	21
2.6.2	The "STOP" Key.....	21
<b>2.7</b>	<b>Imbalance Detection.....</b>	<b>22</b>
<b>2.8</b>	<b>Timer Function.....</b>	<b>22</b>
<b>3.</b>	<b>Maintenance.....</b>	<b>24</b>
<b>3.1</b>	<b>Maintenance and Cleaning.....</b>	<b>24</b>
3.1.1	General Care:.....	24
3.1.2	Cleaning and Disinfecting of the Unit .....	25
3.1.3	Cleaning and Disinfecting of the Rotor .....	25
3.1.4	Disinfection of Aluminum Rotors .....	25
3.1.5	Disinfection of PP-Rotors .....	25
3.1.6	Glass Breakage.....	26
<b>3.2</b>	<b>Lifetime of Rotors, Round and Rectangular Buckets, Accessories.....</b>	<b>26</b>
<b>4.</b>	<b>Trouble Shooting.....</b>	<b>27</b>
<b>4.1</b>	<b>Error Messages: Problem / Solution .....</b>	<b>27</b>
<b>4.2</b>	<b>Survey of Possible Error Messages and Solutions .....</b>	<b>27</b>
4.2.1	Lid Release during Power Failure (Emergency Lid Release) .....	27
4.2.2	Description of the Error Message System .....	28
4.2.3	Procedure while error 14, from software version 1.76 .....	28
4.2.4	Procedure while error 38 – Lid motor is blocked .....	29
<b>5.</b>	<b>Receipt of Centrifuges for Repair.....</b>	<b>30</b>
<b>6.</b>	<b>TRANSPORT, STORAGE AND DISPOSAL.....</b>	<b>31</b>
<b>6.1</b>	<b>Transport.....</b>	<b>31</b>
<b>6.2</b>	<b>Storage .....</b>	<b>31</b>
<b>6.3</b>	<b>Disposal.....</b>	<b>31</b>
<b>7.</b>	<b>APPENDIX.....</b>	<b>III</b>
EC - Conformity Declaration .....	IV	
Table 1: Technical Data .....	V	
Table 2: Permissible Net Weight.....	VI	
Table 3: Max. Speed and RCF-Values for Permissible Rotors .....	VII	
Table 4: Acceleration and Deceleration Times.....	VII	
Table 5: Error Messages.....	VIII	
Tabelle 6: Radius Correction.....	IX	
Table 7: Abbreviations .....	XI	
Redemption Form / Decontamination Certificate .....	XII	

# 1. PRODUCT DESCRIPTION

## 1.1 Safety Instructions



This symbol indicates safety instructions and points of potential dangerous situations. Before using the centrifuge for the first time, please read the operating manual.

Failure to follow these instructions can result in personal injury and/or property damage .

Intended use includes: the observation of all instructions, in the instruction manual, and administering inspection and maintenance.

## 1.2 Intended Purpose

This Hermle centrifuge was designed only for the separation of materials or mixtures with different densities, specifically for the preparation and processing of samples, from the human body, in context of an in-vitro-diagnostic use, to allow the use of in-vitro-diagnostic in accordance to its' intended purpose. The designated device and its' accessories listed, in the technical documentation, are in compliance with Directive 98/79/EC for In-Vitro-Diagnostic Medical Devices.

Hermle Centrifuges are intended exclusively for indoor use and for the use of qualified personnel.

Only Hermle original rotors and accessories should be used. Any other use or intended use is strictly prohibited. For any resulting damage, the company, Hermle Labortechnik, is not liable.

## 1.3 Brief Description

The unit type Z 306, is a non-refrigerated universal centrifuge, which we offer in two voltage variations 230V or 120V.

The centrifuge can be used with swing-out rotors and angle rotors.

All parameters are accessible via buttons, and selected with a central adjuster. All pre-selected and current values will be shown, permanently, on the LCD-Display.

The centrifuge is powered by a Maintenance-Free Induction Motor.

Detailed technical data are in Table 1: "Technical Data" (see APPENDIX P.V).

## 1.4 Delivery Package

- 1 Centrifuge Z 306
- 1 Operating Manual Z 306
- 1 Rotor key

\*Rotor(s) / Accessories will be packaged separately.

### 1.5 Installation of the Centrifuge

#### 1.5.1 Unpacking the Centrifuge

Model Z 306 is supplied in a carton.

Remove the strap retainer, open the carton, and remove the padding.

Lift the centrifuge on both sides (see Figure2) with an appropriate number of helpers and place it on the laboratory table.



**Attention! Do not lift the centrifuge from under the lid or by the front panel!**



*Figure 1*

The instruction manual must be kept with the centrifuge, at all times!

#### 1.5.2 Space Requirements

The centrifuge should be installed on an even, solid surface, if possible on a laboratory cabinet / table or some other solid vibration free surface.

During centrifugation, the centrifuge must be placed in a way, that there is a minimum space of 30 cm/11.81in on each side of the unit, according to EN 61010-2-020 standards.

Do not place the centrifuge next to a window or a heater where it could be disposed to excessive heat, as the performance of the unit is based on an ambient temperature of 23°C/73.4°F.

#### 1.5.3 Installation

Follow These Steps:

- Check whether the power supply corresponds with the one specified on the manufacturer's rating label, mounted on the rear panel.
- The power connection for the centrifuge requires a **separate** one-site protection, with 16 A (Type K)
- In case of emergency, there must be an emergency switch off installed outside of the room, in order to disconnect the power supply from the unit.
- Connect the centrifuge, with the mains.

(The socket for the power cord must be easy to reach, respectively easy to disconnect).

Switch on, by using the mains power switch (I).

Open the lid, by using the button LID.

- Remove the transport securing device of the motor.

## 1.6 Operating and Display Elements

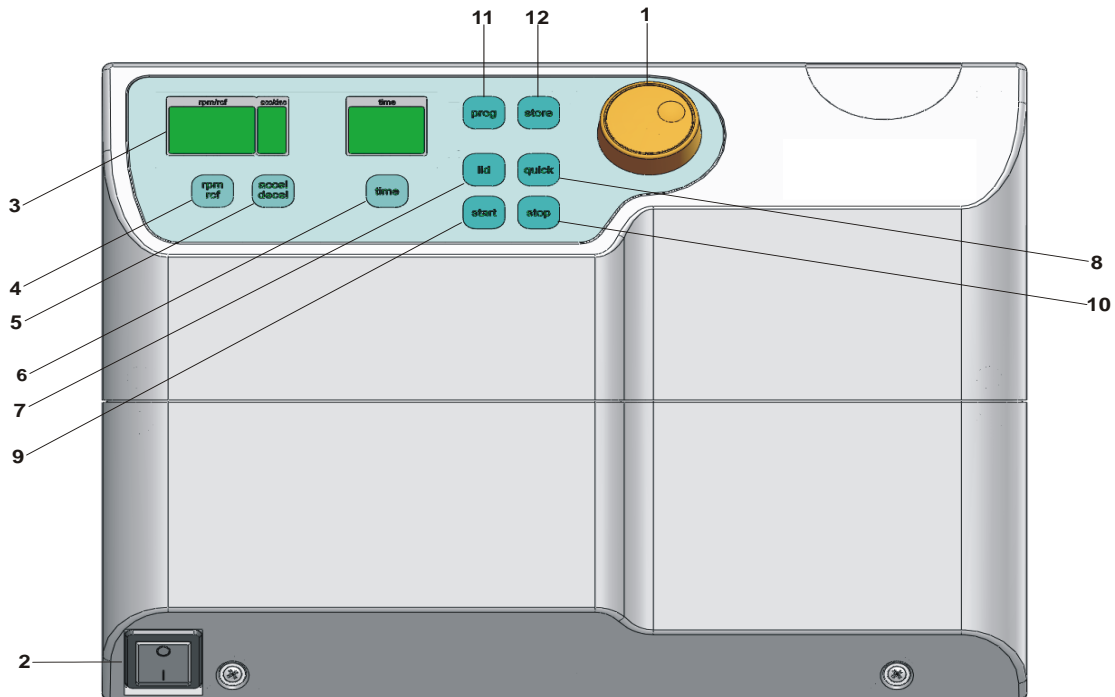

- |    |                         |                                       |
|----|-------------------------|---------------------------------------|
| 1  | <b>central adjuster</b> | Run Parameters                        |
| 2  | <b>0-I</b>              | Power Switch                          |
| 3  | <b>LCD</b>              | Control Panel Display                 |
| 4  | <b>rpm/rcf</b>          | Speed/ g-force                        |
| 5  | <b>accel/decel</b>      | Acceleration / Deceleration Intensity |
| 6  | <b>time</b>             | Centrifugation Time                   |
| 7  | <b>lid</b>              | Lid Release                           |
| 8  | <b>quick</b>            | Short Running                         |
| 9  | <b>start</b>            | Start Centrifugation                  |
| 10 | <b>stop</b>             | Stop Centrifugation                   |
| 11 | <b>prog</b>             | Retrieving Programs                   |
| 12 | <b>store</b>            | Program Store                         |

**Indication:**

After switching on the centrifuge, the display, "rpm/rcf"(A-1) shows the loading status, the current software version and finally the model type (e.g. Z 36 HK).



**1.6.1 LCD-Display**

The following picture shows the individual elements of the LCD-display.

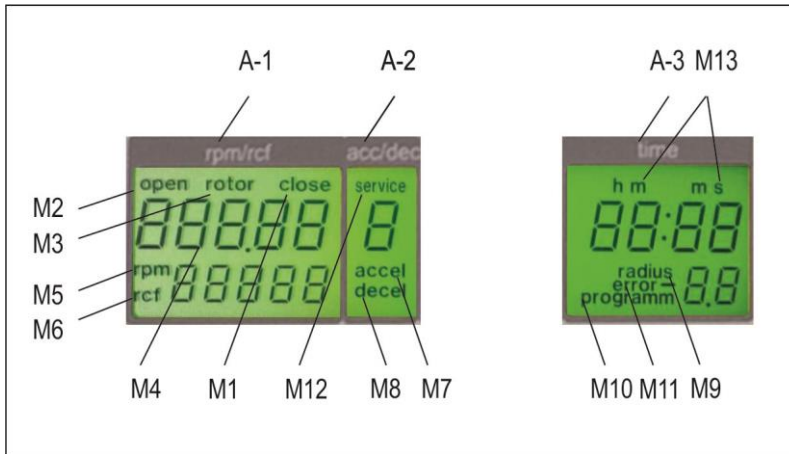

**Figure2**

**Display Fields:**

- A-1 Display Field – "rpm/rcf"
- A-2 Display Field – "acc/dec"
- A-3 Display Field – "time"

**Messages/Logos of the Display Fields:**

M1	"close"	M8	"decel"
M2	"open"	M9	"radius"
M3	"rotor"	M10	"program"
M4	Rotor-No.	M11	"error"
M5	"rpm"	M12	"service"
M6	"rcf"	M13	h m s
M7	"accel"		



## 1.7 Signs and Indications of the Centrifuge

### 1.7.1 General



Instructions for Disposal, (see Chapter 6, P. 28)



Direction of Rotation – clockwise rotation for the rotor drive



Reference for Loading Rotors

### 1.7.2 Product Nameplate (Example)



Company Address: Hermle Labortechnik GmbH, Siemensstr. 25, D-78564 Wehingen

TYPE: Type Designation of the Product

REF: Order No. of the Product

SN: Serial No. of the Product



Manufacturer



Date of Manufacture

MAX. Drehzahl: Max. Speed Allowed of the Unit

KIN. EN.: Max. Kinetic Energy with Corresponding Roto

U/I/f: Allowable Voltage / Max. Current / Frequency

P: Electrical Input Power



Operating Manual Indication



Labeling, Standards and Guidelines



RoHS Conformity

### 1.7.3 Warning and Information Signs

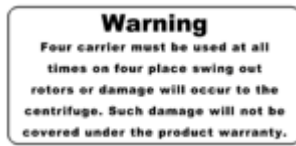

Four carrier must be used at all times on four places swing out rotors or damage will occur to the centrifuge. Such damage will not be covered under the product warranty



Attention! Check the fastening of the rotor nut before each run



Take off mains plug before opening the housing or the emergency release

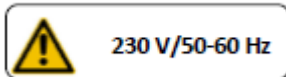

Power Input



Rotation Direction Emergency Release



Biohazard Warning

### 1.7.4 Danger, Precautions and Warranty

 **This device may only be operated by a trained professional. Carefully, read the operating manual and be familiar with the functions of the device.**

To protect people and the environment, the following precautions must be taken:

- During centrifugation, the presence of people and the arrangement of hazardous materials is strictly prohibited, within 30 cm/12 in around the centrifuge, according to the regulations of EN 61010-2-020.
- The HERMLE **Z 306**, is "non-explosion proof" and must not be operated in explosion-endangered areas or locations. Centrifugation of flammable, explosive, radioactive, or such substances, which chemically react with high energy, is strictly prohibited. If used in such environment, this is at the users own expense.
- Never spin toxic or pathogenic material without adequate safety precautions, i.e. centrifugation of buckets / tubes with or without defective hermetic sealing, is strictly prohibited. The user is obliged to perform appropriate disinfection procedures, in case dangerous substances have contaminated the centrifuge and/or its' accessories. When centrifuging infectious substances, always pay attention to the General Laboratory Precautions. If necessary, contact your safety officer!
- It is prohibited to run the centrifuge, with rotors not manufactured for this unit.
- Under no circumstances open the lid of the centrifuge, while the rotor is still running or rotating with a speed of > 2m/s

### 1.7.5 Following Rules Must Strictly be Adhered To:

- Do not operate the centrifuge if not installed correctly.
- Do not operate the centrifuge when dismantled (e.g. without housing).
- Do not run the centrifuge, if mechanical or electrical assembly groups have been tampered with, by unauthorized personnel.
- Do not use accessories such as rotors and buckets, that are not approved by HERMLE Labortechnik GmbH, except commercially available centrifuge tubes, made of glass or plastic.
- Do not spin extremely corrosive substances, as they may cause material damages and impair mechanical resistance.
- Do not operate the centrifuge with rotors or buckets, that show any signs of corrosion or mechanical damage.

The manufacturer is responsible for safety and reliability, of the centrifuge, only if:

- The unit is operated in accordance to this instruction manual.
- Modifications, repairs or other adjustments are performed by HERMLE-authorized personnel and the electrical installation of the related location corresponds to the IEC-regulations.

### 1.7.6 Warranty

The centrifuge has been subjected to thorough testing and quality control. In the unlikely case of any manufacturing faults occurring, the centrifuge and rotors are covered by warranty, for a period of two years, from date of delivery. This warranty becomes invalid in any case of mishandling, damage and/or negligence and further in any case of usage of inappropriate spare parts and / or accessories or unauthorized modification of the unit.

**Technical modification rights are reserved, by the manufacturer, in regards to technical improvement!**

## PRODUCT DESCRIPTION

Attention before first use!

Depending on how the motor shaft of your centrifuge is looking like, some action must be taken before the first operation. Please note the shape of the motor shaft of your centrifuge.

There are two different versions:

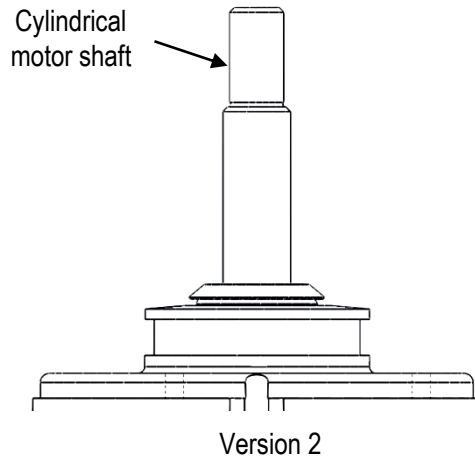
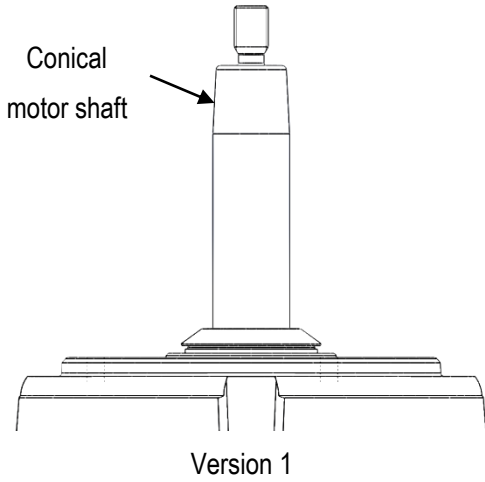

<p>If the motor shaft is conical</p>	<p>remove the collet from the rotor by turning it counter clockwise</p>	<p>The collet is no longer needed</p>	
<p>If the motor shaft is cylindrical</p>	<p>Let the collet inside the rotor</p>		

### 1.7.7 Basic Adjustments

At commissioning of the centrifuge, you have the options to make the following basic changes:

- Acoustic Signal Turn on / off
- Keyboard Sound Turn on / off
- Volume Pre-Selection of Sound Signal
- Song Selection of Sound Signal "end of run"

### 1.7.8 Access to Mode: "Operating Data"

If the centrifuge is still turned off, press the keys, "time" (6) and "lid" (7) simultaneously, turning on the main switch of the centrifuge. Now release both keys. As a result, a display test is administered for approx. 5 seconds. All possible indications will appear at the same time (Figure 3).

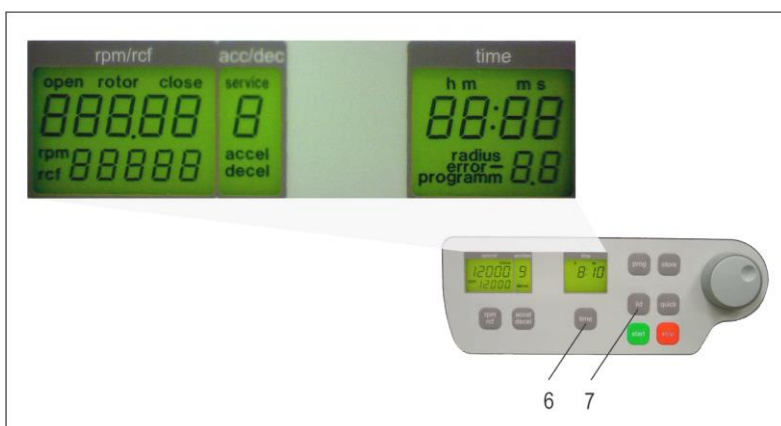

Figure 3

Attention:

- Please notice that you must enter the program as described, under point 1.7.8, to change the adjustments of the points 1.8.2 - 1.8.6. After the settings have been stored by user, the normal program mode can be changed back again by switching off the centrifuge, for a short period.
- All changed settings must be confirmed by the key, "start" (9). A confirmation screen will appear with the word; "store" in the display box, "rpm/rcf"(A-1) - Only then, the pre-selections are valid, (see Figure 4)!

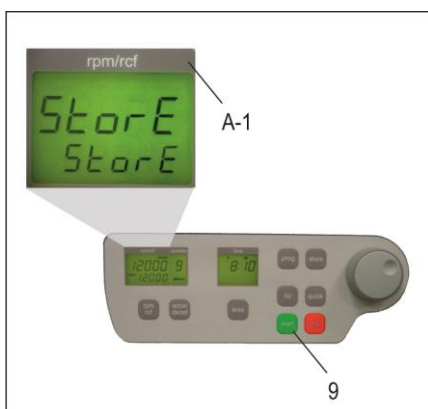

Figure 4

**1.7.9 Sound Signal Turn On / Off**

Proceed as illustrated, under point 1.8.1, to enter this program mode, press the key; "accel/decel" (5). In the display, "accel/decel" (A-2) flashes the word, "service". Select the letter, "L" with the adjustable knob (1). As a result, appearing in the display "rpm/rcf" (4), are the words, "On Sound". By pressing the key, "rpm/rcf" (4), the word "On" flashes, and the sound can be switched off with the adjustable knob (1), (see Figure 5).

After the settings have been stored by user, the normal program mode can be changed back again by switching off the centrifuge, for a short period.

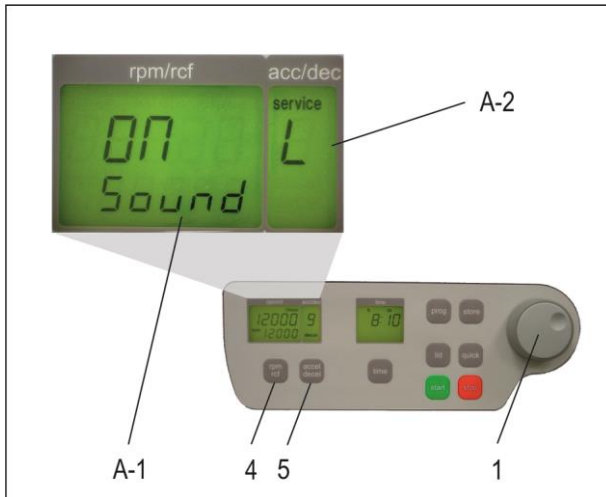

Figure 5

**1.7.10 Volume Pre-Selection of Sound Signal**

Proceed as illustrated, under point 1.8.1, to enter this program mode, press the key "accel/decel" (5). In the display, "accel/decel" (A-2), flashes the word, "service". Select the letter, "U" with the adjustable knob (1). As a result, appearing in the display, "rpm/rcf" (A-1), are the words, "Vol=0-9/Sound". By pressing the key, "rpm/rcf" (4), the desired volume can be adjusted between 0 (low) and 9 (loud), with the adjustable knob (1), (see Figure 6).

After the settings have been stored by user (see 1.8.1), the normal program mode can be changed back again by switching off the centrifuge, for a short period.

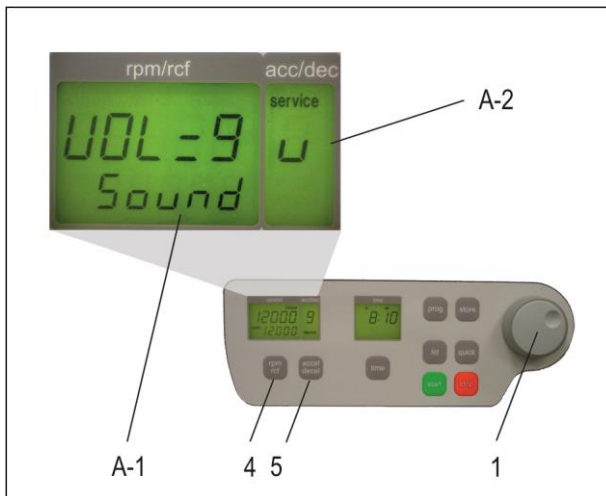

Figure 6

### 1.7.11 Song Selection - End of Run

Proceed as illustrated, under point 1.8.1, to enter this program mode, press the key, "accel/decel" (5). In the display, "accel/decel" (A-2) flashes the word, "service". Select the letter, "G" with the adjustable knob (1). As a result, appearing in the display, "rpm/rcf" (A-1), the word "SonGo/Sound". After pressing the key „rpm/rcf“ (4), select a song with the adjusting knob (1), (see Figure 7).

After the settings have been stored by user, (see 1.8.1), the normal program mode can be changed back again by switching off the centrifuge, for a short period.

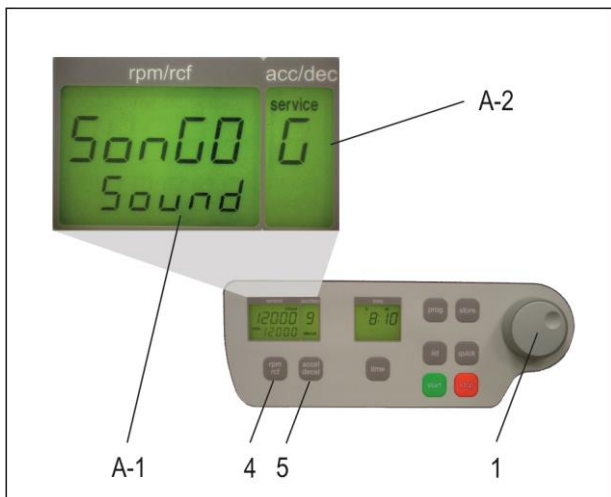

Figure 7

### 1.7.12 Keyboard Sound Turn On / Off

Proceed as illustrated, under point 1.8.1, to enter this program mode, press the key, "accel/decel" (5). In the display; "accel/decel" (A-2) flashes the word, "service". Select the letter, "b" with the adjustable knob (1). As a result, appearing in the display, "rpm/rcf" (A-1), the word "ON/BEEP". By pressing the key, "rpm/rcf" (4), the keyboard sound (On) or (Off) can be turned on, with the adjustable knob (1), (see Figure 8).

After the settings have been stored by user, (see 1.8.1), the normal program mode can be changed back again by switching off the centrifuge, for a short period.

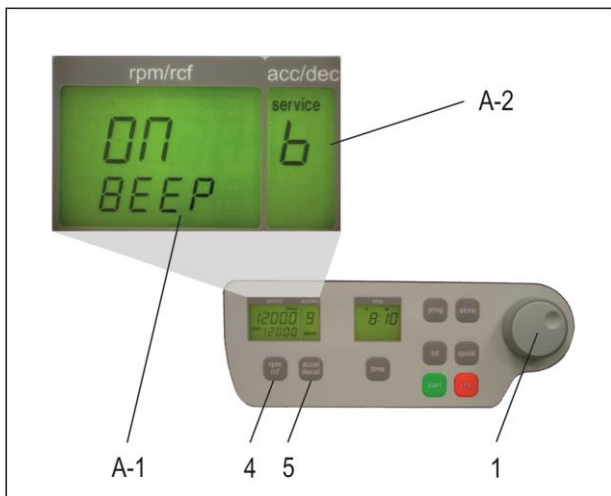

Figure 8

**1.7.13 Retrieving Operating Data (operated by skilled personnel or service engineer only!)**

In the function, "Basic Adjustments", retrieving the operating data of the centrifuge is an available option. Please proceed as illustrated, under point 1.8.1, to enter this program mode, press the key, "accel/decel" (5). In the display, "accel/decel" (A-2) flashes the word, "service".

With the adjustable knob (1), the following information can be retrieved:

- A = Previous Starts of the Centrifuge
- H = Previous Operating Hours
- S = Software Version
- r = Converter Software
- E = List of Previous Error Message
- h = Running Time of the Motor

The list of the last 99 error messages can be reviewed by pressing the key, "rpm/rcf" (4) and scroll through, with the adjustable knob (1). The respective error codes appear in the display, "rpm/rcf" (A-1). Please refer to Table 5: "Error Messages", (see APPENDIX P.IX).

Switch off the centrifuge, to return to the normal program mode.

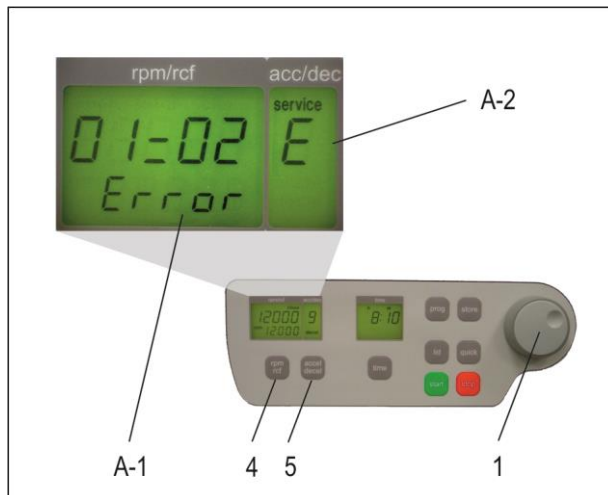

**Figure 9**



## 2. OPERATION

### 2.1 Mounting and Loading the Angle Rotor

#### 2.1.1 Installation of Rotors

Clean the drive shaft and the collet with a clean, grease-free piece of cloth. Place the rotor onto the drive shaft, (see Figure 10). Please be sure that the rotor is fully installed onto the motor shaft.



Figure 10

Hold the rotor with one hand and secure the rotor to the shaft, by turning the fixing nut clockwise. Tighten the fixing nut with the provided Allen key, (see Figure 11).



Figure 11

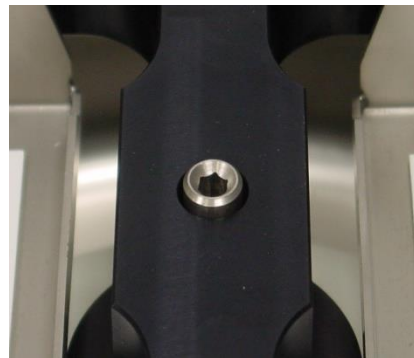

Figure 12

**⚠ ATTENTION:** For safety, always ensure that the rotor fixing screw is tightened before each run,(see Figure 12).

#### 2.1.2 Loading Angle Rotors

Rotors must be loaded symmetrically and with equal weight, (see Figures 12 and 13). The adapter may only be loaded with the appropriate vessels. The weight differences between the filled vessels should be kept as low as possible. Therefore, we recommend to weigh with a balance. This reduces the wear of drive and the acoustic operating noise.

Each rotor indicates what the maximum capacity is per hole. (It is allowed to operate e.g. a 12-place-rotor with 2 or 4 loaded tubes only, but the loaded borings must be opposite of each other).

Figure 13 *WRONG*Figure 14 *RIGHT*

### 2.1.3 Loading Swing Out Rotors

Loading of the buckets / vessels must be done in accordance to Figure 14.

It is allowed to operate e.g. a 4-place-rotor with 2 loaded buckets only. The loaded buckets must be opposite of each other. Make sure that the unloaded buckets are placed inside the rotor, (see Figure 16).

**In principle, swing out rotors cannot be removed during operation, until all buckets or racks are placed inside the rotor.**

**The bolts of the rotor must be greased with the HERMLE Rotorgrease (Order No. 38-5656).** The sample tubes have to be filled evenly, by eye, and set into the drillings or tube racks. The weight difference of the loaded buckets should not exceed 1.0 g.

#### **ATTENTION!**

**Swing Out Rotors can be removed during operation, only if all locations are filled in with either 4 buckets or 4 carriers – do not mix up buckets and carriers!**

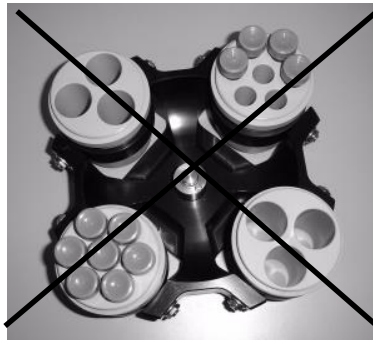
Figure 15: *WRONG*Figure 16: *RIGHT*

#### **ATTENTION!**

**Do not operate the centrifuge with rotors or buckets that show any signs of corrosion or mechanical damage.**

**Do not operate with extremely corrosive substances, which could damage the rotor and buckets.**

**In case of any questions, please contact the manufacturer!**

### 2.1.4 Loading and Overloading of Rotors

All approved rotors are listed with their maximum speed and maximum filling weight, in Table 2: "Permissible Net Weight", (see APPENDIX P. VI).

The maximum load permitted for a rotor is determined by the manufacturer, as well as the maximum speed allowed for this rotor (see label on rotor), must not be exceeded. The liquid the rotors are loaded with, should have a max. homogeneous density of 1.2 g/ml or less when the rotor is running at maximum speed.

In order to spin liquids with a higher density, the speed has to be reduced, according to the following formula:

$$\text{Reduced speed } n_{\text{red}} = \sqrt{\frac{1,2}{\text{higher density}}} \times \text{max. speed } (n_{\text{max}}) \text{ of the rotor}$$

Example:

$$n_{\text{red}} = \sqrt{\frac{1,2}{1,7}} \times 4.000 = 3.360 \text{ rpm}$$

**In case of any questions, please contact the manufacturer!**

### 2.1.5 Removing the Rotor

Completely, untighten the rotor fixing nut (2. screw over the stiff point) and lift the rotor vertically out of the centrifuge, (see Figures 10 and 11).

## 2.2 Lid

### 2.2.1 Lid Release

After the run, properly close the lid of the centrifuge, appearing in the display, "rpm/rcf"(A-1) with the word, "close" (M1). If there is a rotor in the centrifuge, the word, "rotor" (M3) appears, as well as the code number of the specified rotor, which is in the centrifuge, for example "221.72" (M4). If there is no rotor in the centrifuge, it flashes the word, "rotor" (M3) and an additional word, "no" (M4). By pressing the key, "lid" (7), the lid of centrifuge can be released. As soon as the electromagnetic lid is completely released, the word, "open" (M2) appears. The lid of the centrifuge is now able to be opened.

For all number marked text, please refer to Figure 17.

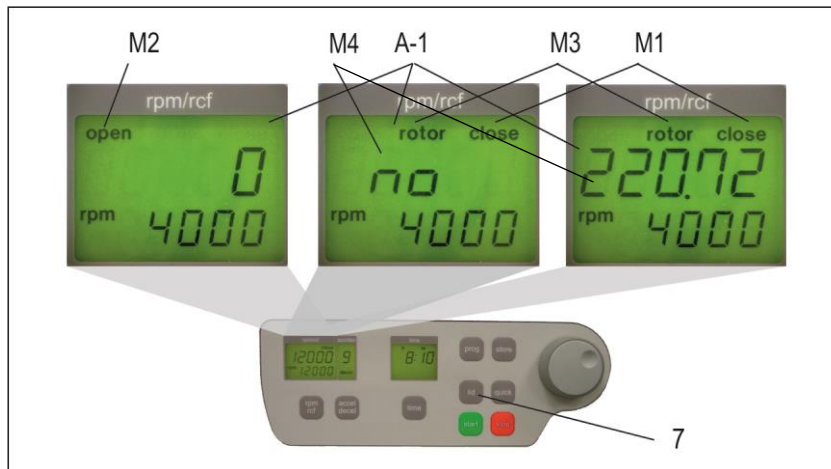

Figure 17

During the run, you can retrieve the rotor type at any time, by pressing the key, "lid" (7).

### 2.2.2 Lid Lock

The lid must only be closed slightly. An electromagnetic lid lock closes the lid, the word "open" (M2) will no longer be displayed.

As a sign that the centrifuge is ready for starting, appearing in the display, "rpm/rcf"(A-1), the word "close" (M1). Simultaneously, the word "rotor" (M3) appears, as well as the code number of the rotor, which is in the centrifuge, i. e. "nr 220.72" (M4), along with all rotor specific data, for example: max. speed, acceleration etc., are available.

For all number marked text, please refer to Figure 17.

**⚠ ATTENTION:** Don't grip your fingers between the lid and the device or the locking mechanism, when closing the lid!

## 2.3 Pre-Selection

### 2.3.1 Pre-Selection of Speed / RCF-Value

Selecting the key, "rpm/rcf" (4), pre-selection is activated. By pressing the key once, the word "rpm" (M5) flashes. By pressing the key again, the pre-selection of the centrifugal forces can be chosen. The flashing word, "rcf" (M6), will appear. The desired values can be selected, with the adjustable knob (1). In the display (A-1), the regulated value is shown permanently: before, during and after the run.

For all number marked text, please refer to Figure 18.

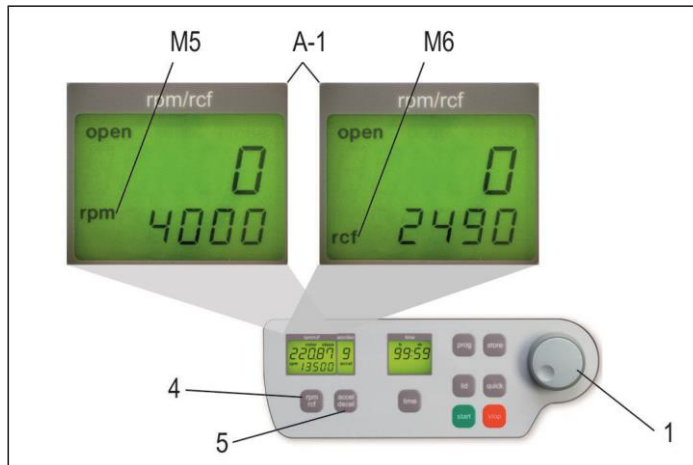

Figure 18

As long as no rotor is inserted, the speed is adjustable between 200 rpm and the maximum revolution of the centrifuge.

If there is a rotor in the centrifuge, the speed can only be pre-selected up to the maximum permissible revolution of that rotor. It is the same with the pre-selection of the RCF-Value. The setting range is between 20 xg and the maximum permissible centrifugal force of the rotor.

See Table 3: "Max. Speed and RCF-Values for Permissible Rotor", (see APPENDIX P. VII). All important values are listed on this table.



#### ATTENTION:

**Please check the maximum permissible revolutions of your test tubes! (Producer Indication)**

### 2.3.2 Pre-Selection of Running Time

The running time can be pre-selected in 3 different ranges: from 10 seconds up to 99 hours 59 minutes.

1. Range from: 10 seconds up to 59 minutes 50 seconds, in steps of 10 seconds
2. Range from: 1 hour up to 99 hours 59 minutes, in steps of 1 minutes
3. Range: Continuous Run "cont", can be interrupted by the key, "stop" (10).

-The running time can be pre-selected, with the lid opened or closed.

-To activate the setting of the running time, press the key "time" (6).

-In the display, "time" (A-3) flashes the indication: "m : s" or "h : m", depending on the previous setting.

To set the desired value, use the adjustable knob (1). After exceeding 59 min 50 sec, the indication changes automatically to, "h : m". After exceeding 99 hours 59 min, the word "cont" appears in the display, "time" (A-3). The continuous run can only be interrupted by pressing the key, "stop" (10). The time counts down, as soon as the set speed is reached.

The display will always show the remaining running time, (see Figure 19).

For all number marked text, please refer to Figure 18.

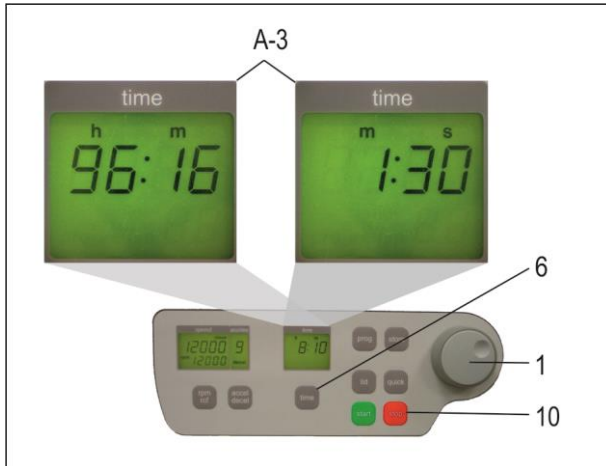

Figure 19

### 2.3.3 Pre-Selection of Brake Intensity and Acceleration

Selecting the key, "accel/decel" (5), this function is activated.

By pressing the key once, the word "accel" (M7) flashes, in the display "accel/decel" (A-2). The desired acceleration can be pre-selected, with the adjustable knob (1). The value 0 is equivalent to the lowest acceleration and the value 9 is equivalent to the highest acceleration.

By pressing the key "accel/decel" (5) twice, in the display "accel/decel" (A-2), indicates the word "decel" (M8). Now the desired brake intensity can be pre-selected, with the adjustable knob (1). The value 9 is equivalent to the shortest possible brake time and the value 0 to longest possible brake time.

For all number marked text, please refer to Figure 20.

See Table 4: "Acceleration and Deceleration Times", (APPENDIX P. VIII). This table shows the acceleration and deceleration times, for the acceleration and deceleration stages 0 to 9, for permissible rotors.

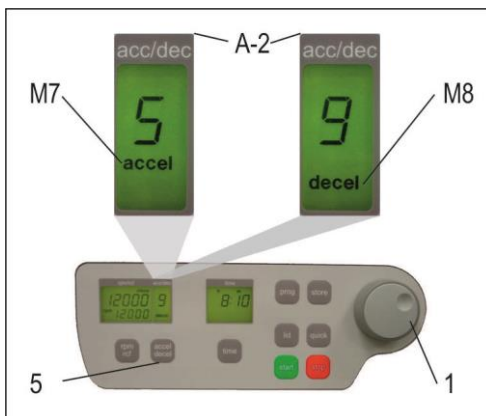

Figure 20

## 2.4 Radius Correction

If adapters or reducers are being used, it could change the centrifugal radius of the respective rotor. In that case, the radius can be corrected manually.

Please proceed as follows:

First close the centrifuge lid and press afterwards the key "time" (6) and the key "prog" (11) at the same time and hold down.

In the display, "time" (A-3), appears the word "radius" (M9). With the adjustable knob (1), pre-select the respective radius correction, (see Table 6, APPENDIX P. X), in steps of 0.1cm.

As soon as the radius correction is set, the word "radius" (M9) appears. This text remains visible until the radius correction is set back to 0.

For all number marked text, please refer Figure 21.

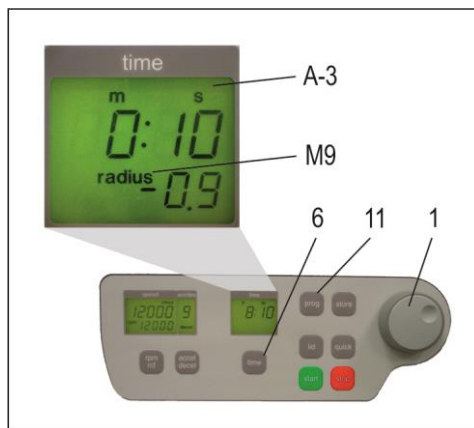

Figure 21

## 2.5 Program

### 2.5.1 Storage of Programs

The program stores up to 99 runs, with all relevant parameters, including the used rotors. Any free program number is available and can be retrieved.

Put the desired rotor into the centrifuge. By pressing the key, "prog" (11), in the display "time" (A-3) appears the word "program", (see Figure 22). With the adjustable knob (1), choose the desired program number.

If a program number is already occupied, in the display "rpm/rcf" (A-1), the words "rotor" (M3) and "22x.xx" (M4) will appear, (see Figure 24). Free program numbers will appear as 0.

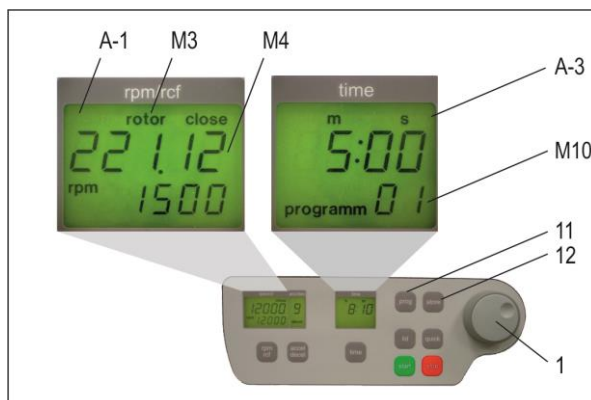

Figure 22



Close the lid of the centrifuge, now proceed as described above, to set all important run parameters. If the lid isn't closed, when storing the program in the display "rpm/rcf" (A-1), flashes alternately the word "FirSt" and "CLOSE Lid" (see Figure 23). When starting the run without storing the program, in the display "rpm/rcf" (A-1), flashes alternately the word "First" and "PrESS StoreE", (see Figure 24).



Figure 23

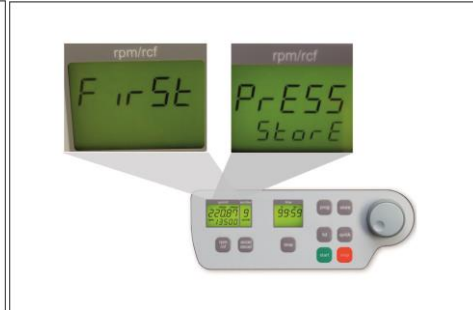

Figure 24

### 2.5.2 Recall of Stored Programs

To recall stored programs, press the key "prog" (11), with the lid already closed. Inside the display "time" (A-3), appears "programm --"(M10). With the adjustable knob (1), pre-select the desired program number.

In the respective displays, the stored values, for that program, will appear.

If there is not the correct rotor inside the centrifuge, for the pre-selected program, in the display "rpm/rcf" (A-1) flashes the word "rotor" (M3). At the same time, the word "FALSE" and the stored rotor number "22x. xx"(M4) flash in sequence of one another.

For all number marked text, please refer to Figure 25.

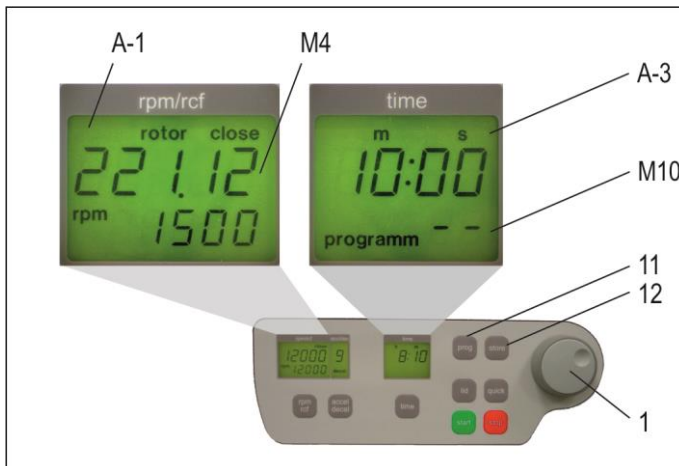

Figure 25

### 2.5.3 Leaving Program Mode

To leave the program mode, press the key, "prog" (11). Then, inside the display "time", appears the word "programm".

Set the display to "programm--" (M10) with the adjustable knob (1).



## 2.6 Starting and Stopping the Centrifuge

### 2.6.1 Starting the Centrifuge

Start the centrifuge with either the "start" key (9), or the "quick" key (8).

With the "start" key (9), stored runs or runs with manually pre-selected parameters can be started.

When the respective pre-selected running time has ended, the centrifuge will stop automatically.

With the "quick" key (8), start runs, which will last a few seconds, can be initiated.

By pressing the "quick" key (8), the centrifuge accelerates up to the pre-selected revolution.

In the display "time" (A-3), the passed running time is indicated from the moment the "quick" key (8) is pressed.

By releasing the "quick" key (8), the centrifuge stops and the running time is indicated, until the lid is opened.

For all number marked text, please refer to Figure 26.

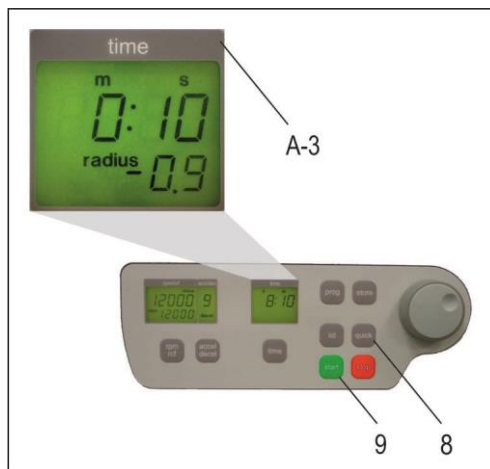

Figure 26

### 2.6.2 The "STOP" Key

With the "stop" key (10), the run time can be interrupted, at any time, (see Figure 27). After pressing the key, the centrifuge decelerates with the respective pre-selected intensity, down to a standstill.

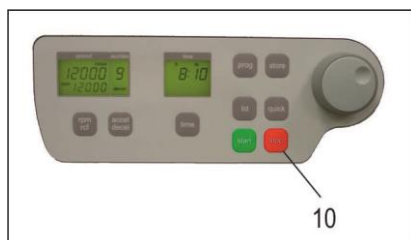

Figure 27

### 2.7 Imbalance Detection

In case the rotor is not equally loaded, the drive will turn off, during acceleration. The rotor decelerates to a standstill.

When in the display "time" (A-3), the word "error" (M11) along with the number "01" appears, the weight difference of the samples are too large. Weigh out the samples exactly!

Load the rotor as described in Chapters: 2.1.1 and 2.1.2.

When inside the display "time" (A-3), the word "error" along with the number "02" appear, (see Figure 28).

Potential Reason for the Error Screen: The imbalance switch is defective.

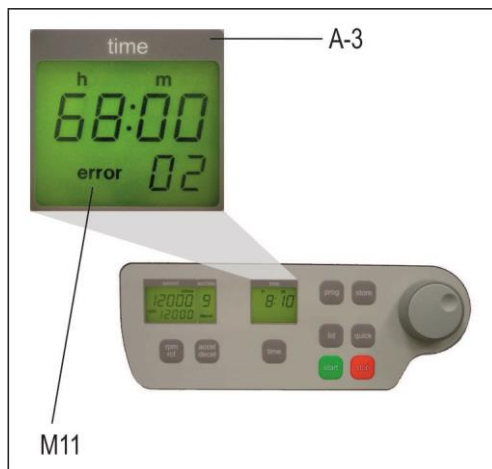

Figure 28

### 2.8 Timer Function

This timer function enables to program a planned ending or start of centrifugation. After closing the centrifuge lid and setting all the needed values, the timer function can be activated.

For this purpose press the bottom „time“ (6) for five seconds. This will take you to the time setting of the timer and the display "rpm/rcf" (A-1) shows the words "End in". The display „time“ (A-3) shows the remaining time until the **end** of the centrifugation. The remaining time can be set between 1 min and 99 h 59 min by pressing the bottom "time" (6) and turning the adjusting knob (1).

Alternatively to the "End in" mode, you can choose the "Start in" mode by pressing the bottom „rpm/rcf“ (4). The display „time“ (A-3) shows the remaining time until the **start** of the centrifugation.

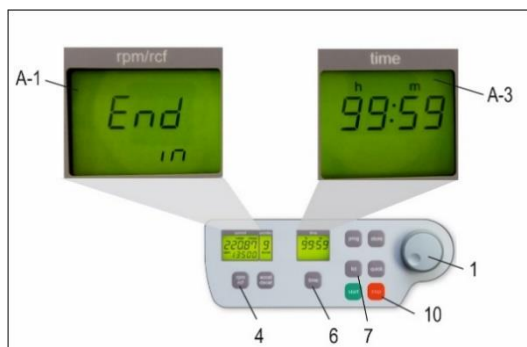

Figure 29

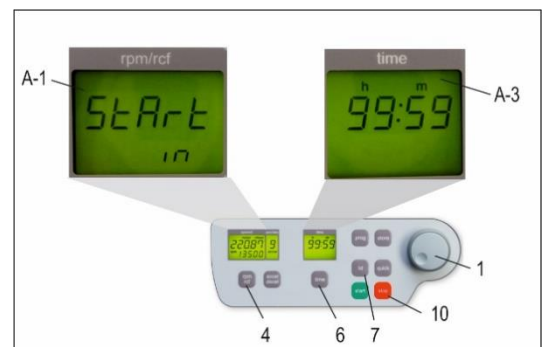

Figure 30

The timer starts automatically after setting the needed value. The set time can be adjusted by pressing again the bottom "time" (6) and turning the adjusting knob (1).

You can interrupt this function by pressing the bottom "stop" (10) or the bottom "lid" (11). During the timer mode, all the other bottoms have no function.

For all number marked text, please refer to Figures 29 and 30.

### 3. Maintenance

#### 3.1 Maintenance and Cleaning

##### 3.1.1 General Care:

Maintenance of the centrifuge is dependent on prolonging the life of the rotor, the rotor chamber and the rotor accessories. Please be sure to clean the accessories, especially the sealing of the aerosol-tight rotors and insert bolts, of swing out rotors. Following, lubricate the bolts or sealing, with the recommended HERMLE Rotorgrease - Order No.: 38-5656.

Please pay special attention to anodized aluminum parts. Breakage of rotors can be caused by the slightest damages.

In case of rotors, buckets or tube racks becoming in touch with corrosive substances, the affected area must be cleaned, thoroughly.

Corrosive substances, such as, must be avoided: alkalis, alkaline soap solutions, alkaline amines, concentrated acids, solutions containing heavy metals, water-free chlorinated solvents, saline solutions, e.g. salt water, phenol, halogenated hydrocarbons.



##### **Cleaning – Units, Rotors, Accessories:**

- Turn the device off and disconnect from the power supply, before beginning any cleaning or disinfecting. Do not pour liquids into the housing interior.
- Spray disinfectant on the device.
- Thorough cleaning not only has its purpose in hygiene, but also in avoiding pollution based corrosion.
- In order to avoid damaging anodized parts, such as rotors, reduction plates etc.; only pH-neutral Detergents, with a pH-value of 6-8, may be used for cleaning. Alkaline cleaning agents must not be used, (pH-value > 8).
- After cleaning, please ensure all parts are dried thoroughly, either by hand or in a hot-air cabinet (Max. Temperature + 50°C/122°F).
- It is necessary to coat anodized aluminium parts with anti-corrosion oil regularly, in order to increase their life-span and reduce corrosion predisposition.
- Due to humidity or not hermetically sealed samples, condensation may form. The condensation has to be removed from the rotor chamber, with a soft cloth regularly.



##### **The maintenance procedure has to be repeated every 10 to 15 runs, but at least once a week!**

- Connect the unit to the power supply, after the equipment is completely dry.
- Do not implement disinfection with UV-, beta- and gamma-rays or other high energy radiation.
- Metal rotors can be autoclaved.
- Rotor lid and adapters can also be autoclaved, (Max. 121°C/250°F, 20 min).
- The tube racks are made of PP and **cannot** be autoclaved, at 134°C/273°F.

### 3.1.2 Cleaning and Disinfecting of the Unit

1. Open the lid, before turning off the unit. Disconnect from the power supply.
2. Open the rotor nut, by turning the rotor key counter-clockwise.
3. Remove the rotor.
4. For cleaning and disinfection of the unit and the rotor chamber, use the above mentioned cleaner.
5. Clean all accessible areas of the device and its accessories, including the power cord, with a damp cloth.
6. Wash the rubber seals and rotor chamber thoroughly, with water.
7. Rub the dry rubber seals with glycerol or talc, to prevent these from becoming brittle. Other components of the unit, e.g. the lid lock, motor shaft and rotor, should **not** be greased.
8. Dry the motor shaft with a soft, dry and lint-free cloth.
9. Examine the unit and accessories for damage.

Remove adherent dust, at least every 6 months, from the ventilation slots in the centrifuge, by using a soft brush.

### 3.1.3 Cleaning and Disinfecting of the Rotor

1. Clean and disinfect: the rotors, rotor lids and adapters, with the cleaner previously mentioned above.
2. Use a bottle brush to clean and disinfect the rotor bores.
3. Rinse the rotors, rotor lid and adapter, with clear water. Particularly, the drillings of the angle rotors.
4. When drying the rotors and accessories, set on a towel. Place the angle rotors, with bores down, to dry.
5. Dry the rotor cone with a soft, dry and lint-free cloth, check for damage. Do not grease the rotor cone.

### 3.1.4 Disinfection of Aluminum Rotors

In case of infectious material spilling into the centrifuge, the rotor and rotor chamber have to be disinfected, promptly after the run. Rotors may be autoclaved, at a maximum temperature of 121°C/250°F.

### 3.1.5 Disinfection of PP-Rotors

#### Autoclaving

The recommended time for autoclaving: 15 – 20 min at 121°C/250°F, (1 bar)



**ATTENTION: The sterilization time of 20 min. must not be exceeded. Continuous sterilization will cause reduction in the mechanical resistance, of the plastic material.**

Before autoclaving the PP-rotor and adapter, thoroughly clean to avoid the burning of dirty residue.

Please disregard any consequences of chemical residues to plastic materials, at ambient temperatures. At high temperatures, autoclaving residue may corrode and destroy the plastic. The objects must be thoroughly washed with distilled water, after the cleaning, but before the autoclaving. Residues of any cleaning liquids, may cause fissures, whitening and stains.

#### Gas Sterilization

Adapters, bottles and rotors may be gas sterilized, with Ethylenoxyd. According to the duration of the application, allow items to properly air out, after the sterilization and before usage



**ATTENTION:** The temperature may rise during the sterilization; rotors, adapters and bottles should not be fully closed, keep completely unscrewed.

### Chemical Sterilization

Bottles, adapters and rotors may be treated, with the usual liquid disinfectants.



**ATTENTION:** Before applying any other, Cleaning Resp. Decontamination Method, other than what was recommended by the manufacturer, contact the manufacturer to ensure that it will not damage the unit or the rotor.

### 3.1.6 Glass Breakage

With high g-values, the rate of glass tube breakage increases. Glass splinters have to be removed immediately from rotor, buckets, adapters and the rotor chamber itself. Fine glass splinters will scratch and therefore damage the protective surface coating of a rotor. If glass splinters remain in the rotor chamber, fine metal dust will build up, due to air circulation. This very fine, black metal dust will severely pollute the rotor chamber, the rotor, the buckets, and the samples.

If necessary, replace the adapters, tubes and accessories, to avoid further damage. Check the rotor bores regularly, for residue and damage.



**ATTENTION:** Please check the relevant specifications of the tubes centrifuges with the manufacturer!

### 3.2 Lifetime of Rotors, Round and Rectangular Buckets, Accessories

Rotors and rotor lid made of aluminum or stainless steel, have a operating time of **max. 7 years** from first use.

Transparent rotor lids and caps, made of PC or PP, as well as rotors, tube racks and adapters of PP, have a maximum operating time of up to **3 years**, from first time use.

Conditions For the Operating Time:

Proper use, damage-free condition, recommended care.

### For additional information on aerosol-tight rotors, lids and buckets, please see below

The aerosol tightness of rotors, rotor lids, buckets and caps have been tested and certified by the "TÜV Nord CERT GmbH, Certification Body Consumer Products, Essen (Germany)", in accordance with Annex AA of IEC 61010-2-020. The certificates can be downloaded on our webpage, [www.hermle-labortechnik.de](http://www.hermle-labortechnik.de). Aerosol-tight rotors and buckets are marked with the label, "aerosol-tight".



**ATTENTION:** Autoclaving, mechanical stresses and contamination, by chemicals or other aggressive solvents, can impair the aerosol-tightness of the rotors and buckets.

- Check the integrity of the seals of the aerosol-tight rotor lids or caps, before each use.
- Use only aerosol-tight rotor lids or caps, if the seals are undamaged and clean.
- Replace the seals of aerosol-tight lids and caps, after 5 autoclaving cycles.
- **Never** store aerosol-tight rotors or buckets closed.

## 4. Trouble Shooting

### 4.1 Error Messages: Problem / Solution

The error messages are listed to help localize possible errors faster.

The possible error referred to in this chapter may not always be the case, as they are only theoretically occurring errors and solutions.

Always keep us informed about any kind of error occurring, which is not listed in this chapter. With this information provided, we are able to improve and complete this operation manual.

Many thanks in advance for your support.

HERMLE Labortechnik GmbH

### 4.2 Survey of Possible Error Messages and Solutions

#### 4.2.1 Lid Release during Power Failure (Emergency Lid Release)

In case of power failure or malfunction, the lid of the centrifuge can be opened manually, in order to protect samples.

Please proceed as follows (see Figure 28):



- **Switch the centrifuge off and unplug the power cord, wait until the rotor is at a standstill, (this may take several minutes).**

At the right side of the centrifuge, there is a plastic stopper, ( Figure 31. Remove this stopper, which is connected to the lid lock, horizontally from the housing until the centrifuge lid opens.

- Now, open the lid of the centrifuge.



Figure 31

#### 4.2.2 Description of the Error Message System

The error message, "error" (M11), is shown in the "time" (A-3) display, (see Figure 32). For more detailed information, refer to Table 6: "Error Messages", (see Appendix P.IX).

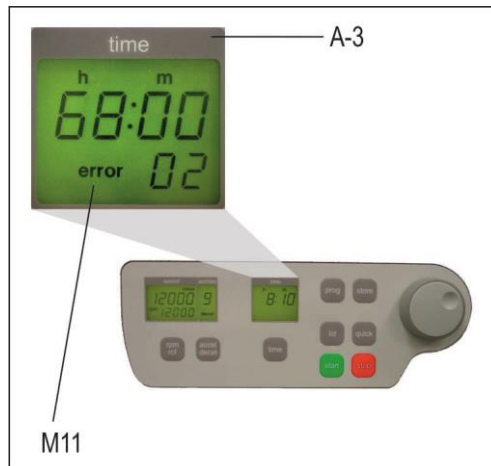

Figure 32

#### 4.2.3 Procedure while error 14, from software version 1.76

If Error 14 occurs, there is a problem with the speed sensor. The centrifuge lid is closed for undefined period of time and in the "rpm/rcf" (A-1) display shows the lettering "USER GuidE" (see Figure 33).

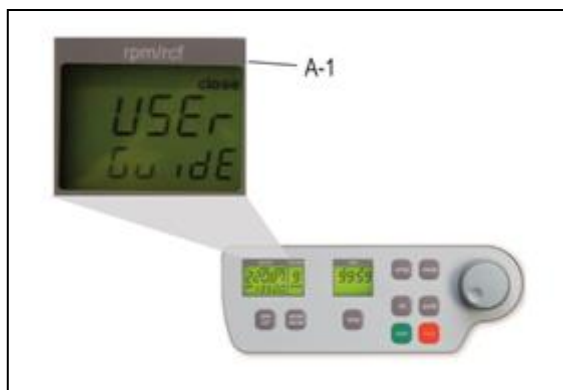

Figure 33

To reopen the centrifuge lid, switch off the device and wait until the rotor has come to a **standstill**. Take from "Table 4: Acceleration and Deceleration Times" the maximum deceleration time of the respective rotor. Level 0 corresponds to unbroken rundown, which occurs at error 14. If the centrifuge lid is opened before standstill of the rotor, a following error can occur.

Once the rotor has come to a standstill, open the centrifuge lid with the emergency release. Proceed as described in chapter 4.2.1, p 26. After opening the centrifuge lid, switch on the device again. Error 14 and the lettering "USER GuidE" should be eliminated.



#### 4.2.4 Procedure while error 38 – Lid motor is blocked

The lid motor is blocked and for 10 seconds the error message “error 38” is shown in the display “time” (A-3). After expiring of this error message please press the key “lid” (7). If the lid lock doesn't loose, repeat this procedure two or three more times. If the lid lock still doesn't loose, the lid must be opened by using the manual emergency release. Proceed as described in chapter 4.2.1. After opening the centrifuge lid, switch on again the device. The lid lock adjusts itself in the basic position. The closing process can be carried out normally again.

If these errors occurs again, please contact the service.

## 5. Receipt of Centrifuges for Repair



### Health risk from contaminated equipment, rotors and accessories

In case of returning the centrifuge for repairing, to the manufacturer, please know the following:

The centrifuge **must** be decontaminated and cleaned, before shipment, for the protection of persons, environment and material.

### Decontamination certificate at goods return delivery, (see APPENDIX P. XIV)

We reserve the right to accept contaminated centrifuges.

Furthermore, all costs that may have occurred during the cleaning and disinfection of the units, will go to the debit of the customer's account.



### Return of Power Cords

In case of a return of a centrifuge, we also ask you to send its power cord. This eliminates the risk of a faulty power cord. If no power cord is attached to the centrifuge, a new one will be delivered and charged.

We ask for your understanding.

## 6. TRANSPORT, STORAGE AND DISPOSAL

### 6.1 Transport

Before transporting, take out the rotor.  
 Only transport the unit in its' original packaging.  
 Use a transport aid, for transporting over longer distances, to fix the motor shaft.

	Air Temperature	Rel. Humidity	Air Pressure
General Transportation	-25 to 60 °C	10 to 75 %	30 to 106 kPa
	-13°F to 140°F		

### 6.2 Storage

During storage of the centrifuge, the following environmental conditions must be observed:

	Air Temperature	Rel. Humidity	Air Pressure
Transport Packaging	-25 to 55 °C	10 to 75 %	70 to 106 kPa
	-13°F to 131°F		

### 6.3 Disposal

In the event of disposing of the product, please observe the applicable legal requirements.

#### Information on the disposal of the electrical and electronic devices, in the European Community:

disposal of the electrical devices is regulated within the European Community, by national regulations, based on EU Directive 2002/96/EC pertaining to waste electrical and electronic equipment (WEEE).

In accordance with this, any devices delivered after 08/13/2005 on a business-to-business basis, including the product, may no longer be disposed of, as a household waste. To document this, the devices have been marked with the following identification:



Because disposal regulations may differ from one country to another, within the EU, please contact your supplier, if necessary.

#### RoHS II Compliance

HERMLE Labortechnik GmbH, Siemensstraße 25, 78564 Wehingen, hereby declares and certifies that all components manufactured are RoHS II compliant, according to the definition and restrictions given by the European Parliament Directive 2011/65/EC. This restricts the use of certain hazardous substances in electrical and electronic equipment.



## 7. APPENDIX

<b>EC - Conformity Declaration.....</b>	<b>IV</b>
<b>Table 1: Technical Data.....</b>	<b>V</b>
<b>Table 2: Permissible Net Weight .....</b>	<b>VI</b>
<b>Table 3: Max. Speed and RCF-Values for Permissible Rotors .....</b>	<b>VII</b>
<b>Table 4: Acceleration and Deceleration Times .....</b>	<b>VII</b>
<b>Table 5: Error Messages .....</b>	<b>VIII</b>
<b>Tabelle 6: Radius Correction .....</b>	<b>IX</b>
<b>Table 7: Abbreviations .....</b>	<b>XI</b>
<b>Redemption Form / Decontamination Certificate.....</b>	<b>XII</b>

**EC - Conformity Declaration****EG Konformitätserklärung  
EC Conformity Declaration**

**Hermle Labortechnik GmbH - Siemensstr. 25 - D-78564 Wehingen – Germany**

Das bezeichnete Produkt entspricht den einschlägigen grundlegenden Anforderungen der aufgeführten EG-Richtlinien und Normen. Bei einer nicht mit uns abgestimmten Änderung des Produktes oder einer nicht bestimmungsgemäßen Anwendung verliert diese Erklärung ihre Gültigkeit.

The Product named below fulfills the relevant fundamental requirements of the EC directives and standards listed. In the case of unauthorized modifications to the product or an unintended use this declaration becomes invalid.

Produkttyp  
Product Type

**Laborzentrifugen mit Zubehör nach „IVD (sonstige Produkte)“  
Laboratory centrifuge with accessories to “IVD (other device)”**

Typenbezeichnung  
Typ Designation

**Z 206 A; Z 207 A; Z 207 H, Z 167 M; Z 207 M, Z 216 M; Z 287 A; Z 306; Z 326; Z 366; Z 446;  
Z 216 MK; Z 32 HK; Z 326 K; Z 366 K; Z 36 HK; Z 446 K, ZK 496**

Einschlägige EG-Richtlinien / Normen  
Relevant EC Directives / Standards

**98/79/EG (Anhang/Annex III); 2014/35/EU; 2014/30/EU, RoHS II 2011/65/EG,  
2006/42 EG ; DIN EN 61010-1: 2011-07; DIN EN 61010-2-020: 2017;  
DIN EN 61010-2-101: 2002  
DIN EN ISO 14971: 2013-04; DIN EN ISO 13485: 2016-08**

**HERMLE**  
LABORTECHNIK

Wehingen, 22.12.2018  
(gültig bis/valid until 21.12.2021)

**Alexander Hermle**  
Geschäftsführer - Managing Director

**Table 1: Technical Data**

Weight without rotor	30 kg			
Max. Speed	14000 min <sup>-1</sup>			
Max. Volume	4 x 100 ml			
Max. RCF	18624 x g			
allowable density	1,2 kg/dm <sup>3</sup>			
allowable kinetic energy	5692 Nm			
Mains Power Connection AC	230 V / 50 Hz 1 ph	120 V / 60 Hz 1 ph		
Voltage Fluctuation	± 10%	± 10%		
Current Consumption	1,3 A	2,4 A		
Power Consumption	0,24 KW	0,3 KW		
Radio Interference	IEC 61326-1			
Audit Requirement (BGR 500)	no			
Ambient Conditions (EN/IEC 61010-1)				
Environment	for indoor use only			
High	Use up to an altitude of 2000 m above MSL			
Ambient Temperature	2°C up to 35 °C			
Max. Relative Humidity	Max. relative humidity 80 % for temperatures up to 31°C, decreasing linearly to 50% relative humidity up to 35°C			
Overvoltage Category (IEC60364-4-443)	II			
Degree of Contamination	2			
Class of Protection I	Class of protection (DIN EN 60529) IP 20			
Notsuitable for use in hazardous environments				
EMV	EN /	FCC Class B	EN /	FCC Class B
Interference Emission, Noise Immunity	IEC		IEC	
	61326-		61326-	
Noise Level (depending on the rotor)	≤ 63dB(A)			
Write from Operator				
Inventory-No.:				
Monitoring-Nr.:				
Environment:				
Maintenance Contract:				
Responsible Service Office	HERMLE Labortechnik GmbH Siemensstraße 25 78564 Wehingen Tel.: (49)7426 / 96 22-17 Fax: (49)7426 / 96 22-49		or dealer service office	
Responsible Dealer				

**Table 2: Permissible Net Weight**

<b>Rotor Number</b>	<b>Max. Speed</b>	<b>Permissible Net Weight</b>
220.50 V20	3500 min-1	4 x 200 g
220.72 V20	4000 min-1	4 x 465 g
220.87 V21	14000 min-1	24 x 3,4 g
220.87 V20	14000 min-1	24 x 3,4 g
221.54 V20	6000 min-1	300 g
221.55 V20	6000 min-1	432 g
221.12 V20	4500 min-1	4 x 340 g
221.16 V20	4500 min-1	2 x 400 g
221.17 V20	12000 min-1	30 x 3,4 g
221.19 V20	4500 rpm	30 x 32 g
221.24 V20	3250 rpm	2 x 70 g
221.25 V20	5000 rpm	6 x 110 g



Table 3: Max. Speed and RCF-Values for Permissible Rotors

Rotor Number	Max. Speed	RCF Value
220.50 V20	3500 min <sup>-1</sup>	1424 xg
220.72 V20	4000 min <sup>-1</sup>	2611 xg
220.87 V21	14000 min <sup>-1</sup>	18624 xg
220.87 V20	14000 min <sup>-1</sup>	18626 xg
221.54 V20	6000 min <sup>-1</sup>	4427 xg
221.55 V20	6000 min <sup>-1</sup>	4427 xg
221.17 V20	12000 min <sup>-1</sup>	15131 xg
221.19 V20	4500 min <sup>-1</sup>	2830 xg
221.16 V20	4500 min <sup>-1</sup>	2716 xg
221.12 V20	4500 min <sup>-1</sup>	3350 xg
221.24 V20	3250 min <sup>-1</sup>	1700 xg
221.25 V20	5000 min <sup>-1</sup>	3801 xg

Table 4: Acceleration and Deceleration Times

Rotor-Number	Acceleration Values		Deceleration Values	
	Level 0	Level 9	Level 0	Level 9
220.50 V20	110	14	250	19
220.72 V20	110	14	170	17
220.87 V21	200	22	230	35
220.87 V20	200	25	230	35
221.54 V20	102	11	167	14
221.55 V20	101	11	206	14
221.12 V20	110	14	170	19
221.16 V20	230	25	340	26
221.17 V20	250	27	280	34
221.19 V20	157	19	370	20
221.24 V20	95	12	230	15
221.25 V20	206	24	870	30
in seconds				
Acceleration Time		Deceleration Time		
from 0 min <sup>-1</sup> -> U <sub>max</sub>		from U <sub>max</sub> -> 0 min <sup>-1</sup>		

Table 5: Error Messages

Error-No.:	Description
1	Imbalance arose
2	Imbalance sensor is defective
4	Imbalance switch has been activated for longer than 5 seconds
8	Transponder in the rotor is defective
14 USEr GuideE	Leap of speed is too large between two measurements. Centrifuge lid is closed for undefined period of time
16	Standstill detection defective
33	Open lid while motor is running
38	Lid motor is blocked
40	Communication with frequency converter disturbed during start
41	Communication with frequency converter disturbed during stop
42	Short circuit in the frequency converter
43	Under-voltage frequency converter
44	Overvoltage frequency converter
45	Over temperature frequency converter
46	Over temperature motor
47	Over current frequency converter
48	Timeout between control unit and frequency converter
49	Other error frequency converter
55	Over Speed
99	Rotor is not allowed in this centrifuge
FALSE	Inserted rotor does not exist in the program
rotor no	Rotor is not detected

Tabelle 6: Radius Correction

<i>Rotor No.</i>	<i>Adapter/Tube-Rack Order-No.</i>	<i>Radius (cm)</i>	<i>Correction (cm)</i>
Swing Out Rotor <b>220.72</b>	605.004	14.6	0
	605.005	14.6	<b>0.0</b>
	605.000/001	14.2	<b>0.4</b>
	705.000	13.7	<b>0.9</b>
	705.001	14.0	<b>0.6</b>
	705.002	14.0	<b>0.6</b>
	705.003	14.0	<b>0.6</b>
	705.005	14.1	<b>0.5</b>
	705.006	14.2	<b>0.4</b>
	705.007	14.0	<b>0.6</b>
	705.008	14.0	<b>0.6</b>
	705.009	14.0	<b>0.6</b>
	705.010	14.0	<b>0.6</b>
	705.011	14.0	<b>0.6</b>
	705.012	14.0	<b>0.6</b>
705.013	13.9	<b>0.7</b>	
Angle Rotor <b>220.87</b>		8.5	0
	704.004	8.2	<b>0.3</b>
	704.005	7.5	<b>1.0</b>
Angle Rotor <b>221.54</b>		11	0
	701.011	10.6	<b>0.4</b>
	701.012	9.1	<b>1.9</b>
	701.015	7.7	<b>3.4</b>
Angle Rotor <b>221.55</b>		11	
	708.019	10.7	<b>0.3</b>
	708.003	10.3	<b>0.7</b>
	708.004	10.6	<b>0.4</b>
	701.011	10.2	<b>0.8</b>
	701.012	8.3	<b>2.7</b>
	701.015	6.7	<b>4.3</b>
Swing Out Rotor <b>220.50</b>		10.2	0

Table 6 (Part 2): Radius Correction

<i>Rotor No.</i>	<i>Adapter/Tube-Rack Order No.</i>	<i>Radius (cm)</i>	<i>Correction (cm)</i>
Swing Out Rotor <b>221.12</b>	626.003	14.8	<b>0</b>
	626.000	13.8	<b>1.0</b>
	626.001	14.0	<b>0.8</b>
	626.002	14.5	<b>0.3</b>
	626.004	14.4	<b>0.4</b>
	626.005	13.5	<b>1.3</b>
	626.006	14.1	<b>0.7</b>
	626.007	13.9	<b>0.9</b>
	626.008	14.1	<b>0.7</b>
	626.009	14.1	<b>0.7</b>
	626.010	14.2	<b>0.6</b>
	626.011	13.7	<b>1.1</b>
	626.012	14.3	<b>0.5</b>
	626.013	14.4	<b>0.4</b>
	626.014	9.3	<b>5.5</b>
	626.015	11.5	<b>3.3</b>
Swing Out Rotor <b>221.16</b>		12.0	<b>0.0</b>
	706.000	12.0	<b>0.0</b>
Angle Rotor <b>221.17</b>		9.4	<b>0.0</b>
	704.004	9.1	<b>0.4</b>
	704.005	8.4	<b>1.1</b>
	707.000	7.5	<b>1.7</b>
	707.001	8.5	<b>0.7</b>
	707.002	8.4	<b>0.8</b>
	707.003	8.9	<b>0.3</b>
	707.004	8.6	<b>0.6</b>
	707.014	8.3	<b>0.9</b>

**Table 7: Abbreviations**

Symbol / Abbreviation	Unit	Description
U (=rpm)	[min <sup>-1</sup> ]	Revolutions per Minute
RZB(=rcf)	[x g]	Relative Centrifugal Force
PP	-	Polypropylene
PC	-	Polycarbonate
accel	-	Acceleration
decel	-	Deceleration

Redemption Form / Decontamination Certificate

## Decontamination Certificate of Goods Returned upon Delivery

Enclose all returned shipping items and modules necessary!

The complete, full declaration about the decontamination is a prerequisite for the assumption and further processing of the return. If no corresponding explanation is enclosed, we carry out decontamination with costs at your expense.

Surname; Last Name: \_\_\_\_\_

Organization / Company: \_\_\_\_\_

Street: \_\_\_\_\_

ZIP CODE: \_\_\_\_\_ place: \_\_\_\_\_

Telephone: \_\_\_\_\_ fax: \_\_\_\_\_

E-Mail: \_\_\_\_\_

Please fill out in block capitals!

Pos.	Quantity	Decontaminated Object	Serial No.	Description/Comment
1				
2				
3				
4				

**Are the parts listed above in touch with the following substances?**

Health endangering watery solutions, buffers, acids, alkalis:.....  Yes  No

Potentially infectious agents: .....  Yes  No

Organic reagents and solvent: .....  Yes  No

Radioactive substances: .....  α..  β..  γ..  Yes  No

Health endangering proteins: .....  Yes  No

DNA: .....  Yes  No

Have these substances reached the equipment/assembly? .....  Yes  No

If so, which ones: \_\_\_\_\_

Description of the measures for the decontamination of the listed parts:  
 \_\_\_\_\_  
 \_\_\_\_\_  
 \_\_\_\_\_  
 \_\_\_\_\_

I confirm the proper decontamination:

Company/Dept . \_\_\_\_\_ Place and Date: \_\_\_\_\_

Signature of the authorized person: \_\_\_\_\_



**HERMLE**   
LABORTECHNIK  
HERMLE Labortechnik GmbH  
Siemensstraße 25  
78564 Wehingen  
Tel: 0 74 26-96 22-17  
Fax: 0 74 26-96 22-49  
Email: [vertrieb@hermleLT.de](mailto:vertrieb@hermleLT.de)  
Internet: <http://www.hermle-labortechnik.de>

Technical modification rights reserved.  
©HERMLE Labortechnik GmbH 2019