



TDR100 Cable Length Tester



Introduction

Congratulations on your purchase of Tripplett's TDR100 Cable Length Tester. The TDR100 uses TDR (Time Domain Reflectometer) Technology to measure cable length.

Safety

Safety Procedures

Please read this manual carefully and completely before you use the device for the first time. The device may only be used by qualified personnel. Damage or injuries caused by non-observance of the manual are excluded from our liability and not covered by our warranty.

- The device must only be used as described in this instruction manual. If used otherwise, this can cause dangerous situations for the user and damage to the meter.
- The instrument may only be used if the environmental conditions (temperature, relative humidity) are within the ranges stated in the technical specifications. Do not expose the device to extreme temperatures, direct sunlight, extreme humidity or moisture.
- Do not expose the device to shocks or strong vibrations.
- The case should only be opened by qualified Instruments personnel.
- Never use the instrument when your hands are wet.
- You must not make any technical changes to the device.
- The appliance should only be cleaned with a damp cloth. Use only pH-neutral cleaner, no abrasives or solvents.
- Before each use, inspect the case for visible damage. If any damage is visible, do not use the device.
- Do not use the instrument in explosive atmospheres.
- The measurement range as stated in the specifications must not be exceeded under any circumstances.
- Non-observance of the safety notes can cause damage to the device and injuries to the user.

Meter Description

1. BNC socket – to measure cable length via Coax option
2. RJ45 socket - to measure cable length via network option
3. LCD
4. OK / measuring key
5. Coax-network switch key
6. Set key
7. ▲ key (up / increase value)
8. ▼ key (down / decrease value)
9.  key (On/off / in menu: back)

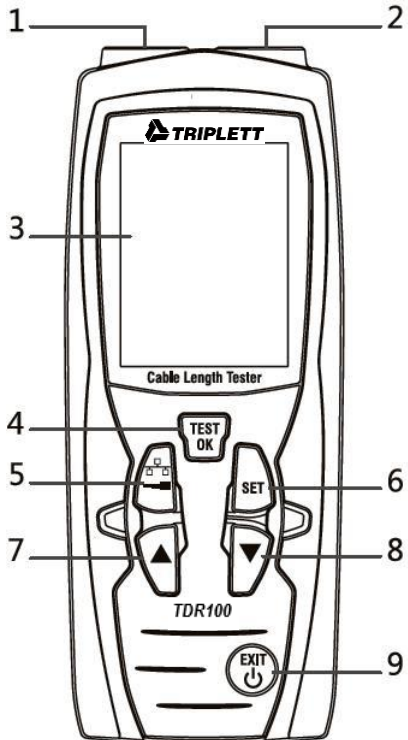

Operating Instructions



Installing Batteries

To run the cable length meter, the included batteries must be inserted first. To do so, turn around the meter and open the battery compartment cover at the rear side. Insert the batteries as marked in the battery compartment. Then close the battery compartment cover.

Note:

Replace the batteries as soon as the battery icon in the display glows in red. Only use 1.5 V AA Alkaline batteries. If you will not use the cable fault tester for a longer period of time, remove the batteries.



Powering ON/OFF



Press and hold the  key for approx. 3 seconds to turn on the meter. To turn off the meter, press and hold the  key for approx. 3 seconds again.

Note:

The meter has an automatic power off function to save battery power. The cable length meter will turn off automatically after 10 minutes of inactivity.







Function Menus

After powering on, the cable fault meter will be in the mode to measure network cables. To enter the main menu, short-press the  key. To return to measuring mode, short-press  again.

When you are in the main menu, you can use the  and  keys to select one of the following functions which you can confirm with

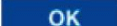

Menu Structure and Navigation

	Cable Test	Cable length measurement
	History	History of past Measurements
	Velocity of propagation	Setting Velocity Propagation
	Setting	System settings
		Up in the menu
		Down in the menu
	OK	Confirm selection

with  key

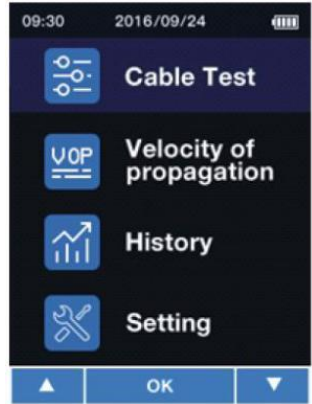



Cable Length Measurement - Setup

Connect the cable to be measured to the meter. If you wish to measure a network cable with RJ45, use the RJ45 socket. If you wish to measure a coaxial cable or measure a cable via the coaxial adaptors, use the BNC socket. Press the  button to select the Network (RJ45) or Coaxial Cable Mode.

It is also possible to make a cable length measurement via the main menu. To do so, select the upper menu item and confirm your selection with the  key.

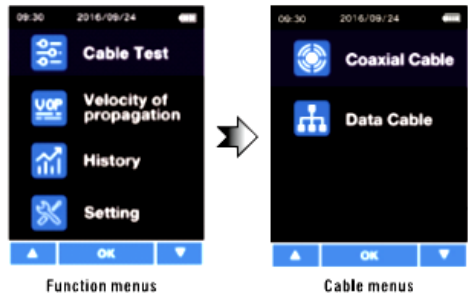
Now select in the following screen whether you wish to use the RJ45 or the BNC socket to measure a cable.



Items	Description
 Coaxial Cable	Coaxial cable measurement
 Data Cable	Network cable measurement

Confirm your selection with the  key. As soon as you have entered the mode for cable length measurements, the screen will look as follows after making a selection:

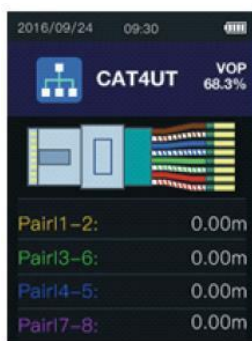



Measuring mode for coaxial cables and cables connected to the meter with a measuring adaptor





Measuring mode for the length measurement of cables connected to the RJ45 socket

NOTE: Do not use on any cables carrying current.

Selecting the cable type



To measure the cable length accurately, it is necessary to select the correct cable type and propagation velocity of the measuring signal (VOP) prior to the measurement.

1. Press the  key to be able to select the cable type from the database of the cable length tester with the  key.
2. The velocity of propagation of the selected cable can only be changed manually for this

measurement. To do so, press and hold the  key in measuring mode. In the upper right part of the display, the VOP value will now be displayed with a black background. This VOP value can now be changed via the  and  keys. To confirm the change, short-press the  key.

Cable length measurement

If you have selected the correct cable setup as previously described you can now make a measurement

by pressing the  button. After the cable length measurement, the reading will be displayed. To leave measuring mode, short-press the  key.

Cable VOP library

To open the VOP library, first go to the menu. Select the menu item "Velocity of propagation". Then select "VOP Library". Then select the library you wish to open. You can select either the library "Coaxial Cable" or "Data Cable".



09:30 2016/09/24

Coaxial Library

Num	Name	Producer
1	CoaxFo	MBBNM
2	CoaxSo	ADHD
3	CW1308	EFDG
4	BT2002	S24R
5	RJ58	GFERTD
6	coAXA	SOUTHW

▲ OK SET ▼

09:30 2016/09/24

Data Library

Num	Name	Producer
1	cAT4UT	MBBNM
2	cAT5UT	ADHD
3	cAT5ST	EFDG
4	cAT6ST	S24R
5	cAT6UT	GFERTD
6	cAT7ST	SOUTHW

▲ OK SET ▼



As a last step, select your cable with the  key.

09:30 2016/09/24

CAT4UT

Name:	CAT4UT
Type:	Data
Producer	MBBNM
V.O.P:	68.3%
Impedance:	75

OK CLR

You can go back to the library by pressing the current cable. With the  key, you can delete the current cable. To confirm the deletion, press . To cancel the deletion, press the  key.

Pre-set cable types					
The cable types pre-set in the TDR100 are:					
Network cable			Coaxial cable		
No.	Name	Producer	No.	Name	Producer
1	CAT3UT	HANWEI	1	CW1308	PE
2	CAT4UT	HANWEI	2	CFPE50	FOAMED
3	CAT4ST	DINTEK	3	CFPE75	FOAMED
4	CAT5UT	DINTEK	4	CSPE50	SOLLID
5	CAT5ST	SHIP	5	CSPE75	SOLLID
6	CAT6UT	SHIP	6	ET9901	PVC
7	CAT6ST	DINTEK	7	ET9903	PVC
8	CAT6ES	DINTEK	8	IBME3	TELLON
9	CAT6EU	DINTEK	9	IBME9	FOAMED
10	CAT7ST	DINTEK	10	BT2002	FOAMED
11	CAT3UT	NEXAN	11	COR50	AIR
12	CAT4UT	NEXAN	12	COR75	AIR
13	CAT4ST	NEXAN	13	COR550	AIRPE
14	CAT5UT	IBDN	14	COR575	AIRPE
15	CAT5ST	IBDN	15	RG6U	FOAMED
16	CAT6UT	IBDN	16	RG59BU	VBFH
17	CAT6ST	SIEMON	17	RG62AU	PVC
18	CAT6ES	SIEMON	18	TPPVC	PVC
19	CAT6EU	SIEMON	19	EPPE	PE
20	CAT7ST	SIEMON	20	BS6500	PP

Adding cables of known lengths

Each cable has its own VOP. If the VOP of the cable is unknown, it can be determined by making a measurement. To do so, the cable length must be known. To make a measurement, follow these steps:

First connect the cable to be measured. It is recommended to use a cable that is longer than 10 m. Now enter the menu. Select "Velocity of propagation". Then select "VOP Test".







Under "length", enter the length of the connected cable. You can select a value between 5 ...

999 m. To change the value, first press the  key to select the box. The value can then be

changed with the keys  / . Press  to confirm the entered value. The VOP value will be displayed directly.

In the "Name" box, you can assign a name to the cable, for instance "NYM 1.5". Up to six digits

are possible. To select the input field, press the  key. With the  /  keys you can select

the number or letter. You can go to the next digit with the  key.

Confirm your entry with the  key.

In the "Type" box, you can select the type of cable. You can choose "Coaxial cable" or "Network

cable". To change the value, press the  key to select the box. The value can then be

changed with the keys  / . Press  to confirm the entered value.

In the "Producer" box, you can enter the manufacturer of the cable. Up to six digits are possible.

To select the input field, press the  key. With the  /  keys you can select the number

or letter. You can go to the next digit with the  key. Confirm

your entry with the  key. In the "Impedance" box, you can select the impedance of the cable. You can choose either 51

Ω , 75 Ω or 100 Ω . To change the value, press the  key to select the box. The value can then

be changed with the keys \blacktriangle / \blacktriangledown . Press  to confirm the entered value.

After making all desired settings, press  to save the entered cable to the library.

Adding cables with known VOP values

If the VOP value of the cable is known, you can add it without making a reference measurement. First enter the menu. Then select "Velocity of Propagation" and "VOP Set".



In the "Name" box, you can assign a name to the cable, for instance "NYM 1.5". Up to six digits

are possible. To select the input field, press the  key. With the \blacktriangle / \blacktriangledown keys you can select

the number or letter. You can go to the next digit with the  key.

Confirm your entry with the  key.



In the "Type" box, you can select the type of cable. You can choose "Coaxial cable" or "Network

cable". To change the value, press the  key to select the box. The value can then be



changed with the keys  / . Press  to confirm the entered value.



In the "Producer" box, you can enter the manufacturer of the cable. Up to six digits are possible.

To select the input field, press the  key. With the  /  keys you can select the number

or letter. You can go to the next digit with the  key. Confirm your entry with the  key.

In the "VOP" box, you can enter the known VOP value. To select the input field, press the  key.

With the  /  keys you can select the number or letter. You can go to the next digit

with the  key. Confirm your entry with the  key.

After making all desired settings, press  to save the entered cable to the library.

Viewing the history

To view the history of the cables last used, first enter the menu. Then select "History". The cables last used will be displayed directly for your selection. You can select the desired cable

with the ▲ / ▼ keys. To confirm your selection, press .

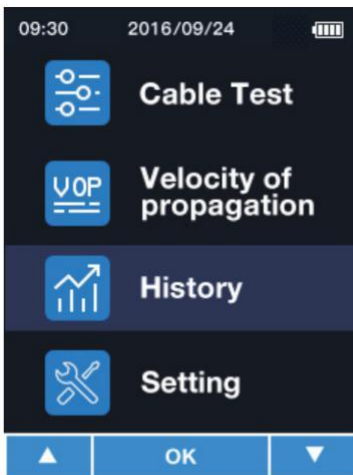

Function menus

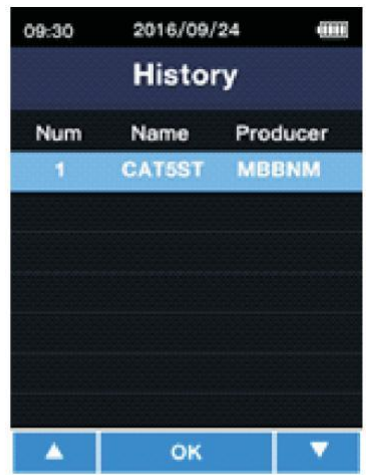

History

NOTE: Measured values will not be saved.

Settings

Enter the menu to make settings. Select "Setting".

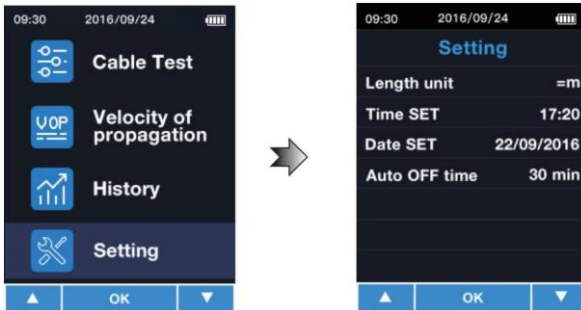



In this menu, the following settings can be made:

Menu	Description
Length Unit	Here you can set the unit. You can select meters "m" or feet "ft".
Time SET	Here you can set the time. Format HH:MM
Date SET	Here you can set the date. Format YYYY/MM/DD
Auto OFF time	Here you can set the time of inactivity after which the meter turns off automatically. Possible options: 10,20,30,40,50 or 60 minutes

With the ▲ / ▼ keys, you can select an item from the Setting menu. The input field can be

selected with the  key. The parameter can now be changed with the ▲ / ▼ keys. Press

 again to go to the next parameter or to confirm your setting.

Press the  key to confirm the setting directly.

Specifications

Measuring range cable length	Depending on the propagation speed of the tested cables 5 ... 3000 m / 16.4 ... 9842.5 ft with shortening factor $\leq 99.9\%$ 5 ... 2400 m / 16.4 ... 7874.0 ft with shortening factor $\leq 80.0\%$ 5 ... 2000 m / 16.4 ... 6561.7 ft with shortening factor $\leq 66.0\%$ 5 ... 1500 m / 16.4 ... 4921.3 ft with shortening factor $\leq 50.0\%$
Measurement units	m, ft
Resolution	0.1 m
Measuring principle	Time domain reflectometer
Selection area	Automatic control range
Measurement accuracy	$\pm [2\% \text{ of reading} \pm 0.2 \text{ m}] < 100 \text{ m}$ $\pm [2\% \text{ of reading} \pm 0.5 \text{ m}] > 100 \text{ m}$
Impedance selector	Automatic output of the impedance control
Shortening factor / propagation speed	Adjustable from 1.0 ... 99.9%
Cable types	20 standard cables
Memory	99 memory slots for individual cables
Connector type	BNC, RJ45
Power supply	2 x 1.5V AA battery
Battery status indicator	Yes
Automatic shutdown	Adjustable between 10 and 60 minutes
Operating temperature	0 ... 40°C / 32 ... 104°F
Storage temperature	-10 ... 50°C / 14 ... 122°F
Relative humidity	0...80%RH

- 1 x TDR100 Cable Length Tester
- 2 x Test leads
- 2 x Crocodile clip
- 2 x AA battery 1.5V
- 1 x Transport bag
- 1 x User manual

Warranty Information

Triplett / Jewell Instruments extends the following warranty to the original purchaser of these goods for use. Triplett warrants to the original purchaser for use that the products sold by it will be free from defects in workmanship and material for a period of (1) one year from the date of purchase. This warranty does not apply to any of our products which have been repaired or altered by unauthorized persons in any way or purchased from unauthorized distributors so as, in our sole judgment, to injure their stability or reliability, or which have been subject to misuse, abuse, misapplication, negligence, accident or which have had the serial numbers altered, defaced, or removed. Accessories, including batteries are not covered by this warranty

Copyright © 2020 Triplett