

True RMS Autoranging Digital Multimeter

MODEL EX505A



Table of contents

1	Introduction.....	1
2	Safety	2
2.1	International Safety Symbols	3
2.2	Input Protection Limits	3
2.3	FCC Compliance	4
3	Product Description	5
3.1	Meter Front	5
3.2	Meter Back	6
3.3	Button Descriptions.....	7
3.4	Display Description	8
4	Meter Power	9
4.1	Automatic Power Off (APO).....	9
5	Operation	10
5.1	Automatic and Manual Range	10
5.2	MODE Button	10
5.3	LCD Backlight.....	11
5.4	Maximum and Minimum Readings.....	11
5.5	Relative (REL) Mode	11
5.6	Data Hold	11
5.7	AC/DC Voltage (Frequency, Duty Cycle) Measurements	12
5.7.1	Frequency and Duty Cycle of AC Voltage Measurements	13
5.8	10 A AC/DC Current Measurements	14
5.8.1	Frequency and Duty Cycle of 10 A AC Current Measurements	14
5.9	μ A, mA AC/DC Current Measurements.....	15
5.9.1	Frequency and Duty Cycle of μ A and mA AC Current Measurements.....	16
5.10	Resistance Measurements	17
5.11	Continuity Test	18
5.12	Diode Test.....	19
5.13	Capacitance Measurements	21
5.14	Frequency and Duty Cycle Measurements (Electronic)	22
5.15	Type K Thermocouple Temperature Measurements.....	23

Table of contents

6	Maintenance	24
6.1	Cleaning and Storage.....	24
6.2	Battery Replacement.....	25
6.3	Fuse Replacement.....	26
7	Specifications	27
7.1	General Specifications.....	27
7.2	Electrical Specifications.....	28
7.3	Measurement Specifications.....	28
8	Customer Support	32
9	Warranty	33

1 Introduction

Congratulations on your purchase of the Extech EX505A True RMS Autoranging Multimeter. This meter measures AC/DC Voltage, AC/DC Current, Resistance/Continuity, Capacitance, Frequency, Duty Cycle, Diode, and Temperature.

This meter features a water-proof, rugged design intended for heavy duty use. This meter is shipped fully tested and calibrated and, with proper use, will provide years of reliable service.

2 Safety

The following safety information must be observed to ensure maximum personal safety while operating this meter.



WARNING



- Improper use of this meter can cause damage, shock, injury or death. Read and understand this user manual before operating the meter.
- Do not use the meter if the meter or test leads appear damaged, or if the meter is not operating properly.
- If the equipment is used in a manner not specified by the manufacturer, the protection provided by the equipment may be impaired.
- Use caution when working with signals > 60 V DC or 30 V AC RMS, such voltages pose a shock hazard.
- Never apply voltage or current to the meter that exceeds the specified maximum. Measuring voltage which exceeds these limits can damage the meter and expose the operator to a shock hazard. The voltage limits are printed on the front of the meter and listed in the table in Section 2.2.
- Never operate the meter unless the back cover and the battery and fuse covers are in place and fastened securely.



WARNING

- Never ground yourself when taking electrical measurements. Do not touch exposed metal pipes, outlets, fixtures, etc., which might be at ground potential. Keep your body isolated from ground by using dry clothing, rubber shoes, rubber mats, or other approved insulating material.
- When using the test lead probes, keep your fingers behind the finger guards on the test lead probes.
- Turn off power to the circuit under test before opening the circuit. Small amounts of current can be dangerous.
- Always discharge capacitors and remove power from the device under test before performing Diode, Resistance or Continuity tests.
- Never connect the meter leads across a voltage source while the function switch is in the current, resistance, or diode mode. Doing so can damage the meter.
- When changing ranges, always disconnect the test leads from the circuit under test.
- Some test lead probe tips may not be long enough to reach the live parts inside some voltage outlets (especially 240 V outlets) because the contacts are recessed deep in the outlets. As a result, the reading may show zero (0) volts when the outlet is actually live and has voltage present.
- Do not place or use the device in strong direct sunlight for extended periods.

2.1 International Safety Symbols

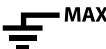
	This symbol adjacent to another symbol, terminal or operating device indicates that the operator must refer to an explanation in the operating instructions to avoid personal injury or damage to the meter.
	This symbol adjacent to one or more terminals identifies them as being associated with ranges that may, in normal use, be subjected to particularly hazardous voltages. For maximum safety, the meter and its test leads should not be handled when these terminals are energized.
	Double insulation.
WARNING	This WARNING symbol indicates a potentially hazardous situation, which if not avoided, could result in death or serious injury.
CAUTION	This CAUTION symbol indicates a potentially hazardous situation, which if not avoided, may result in damage to the product.
	This symbol advises the user that the terminal(s) so marked must not be connected to a circuit point at which the voltage, with respect to earth ground, exceeds 1000 V AC or V DC.

2.2 Input Protection Limits

Never apply voltage or current to the meter that exceeds the specified maximum.

Function	Maximum Input
Voltage DC and AC	1000 V DC or AC RMS
Current DC and AC (μ A, mA)	600 mA (1000 V) fast acting fuse
Current DC and AC (A)	10 A (1000 V) fast acting fuse (30 seconds max. every 15 minutes)
Frequency, Resistance, Capacitance, Diode, Continuity	250 V DC and AC RMS
Temperature (Type K)	250 V DC and AC RMS

2.3 FCC Compliance

This equipment has been tested and found to comply with the limits for a Class B digital device, pursuant to part 15 of the FCC Rules. These limits are designed to provide reasonable protection against harmful interference in a residential installation. This equipment generates, uses, and can radiate radio frequency energy and, if not installed and used in accordance with the instructions, may cause harmful interference to radio communications. However, there is no guarantee that interference will not occur in a particular installation. If this equipment does cause harmful interference to radio or television reception, which can be determined by turning the equipment off and on, the user is encouraged to try to correct the interference by one or more of the following measures:

1. Reorient or relocate the receiving antenna.
2. Increase the separation between the equipment and receiver.
3. Connect the equipment into an outlet on a circuit different from that to which the receiver is connected.
4. Consult the dealer or an experienced radio/TV technician for help.

**WARNING**

Changes or modifications not expressly approved by the party responsible for compliance could void the user's authority to operate the equipment.

3 Product Description

3.1 Meter Front

1. LCD with backlight.
2. Control buttons (Section 3.3).
3. Function switch.
4. 10 A positive test lead input.
5. μA and mA positive test lead input.
6. Voltage, frequency, duty cycle, resistance, diode, continuity, capacitance, temperature positive test lead input.
7. Negative (common) input test lead input.

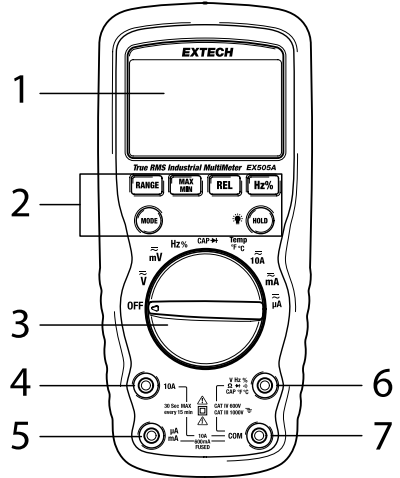

Figure 3.1 Meter Front.

3.2 Meter Back

1. Lanyard hole.
2. Screws (silver) that secure housing (remove to access fuses).
3. Test lead holders.
4. One of the two screws (black) that secures the battery compartment.
5. Tilt stand.
6. Battery compartment.
7. Screws (silver) that secure housing (lift tilt stand to access them).
8. Second screw (black) that secures battery compartment (lift tilt stand to access it).

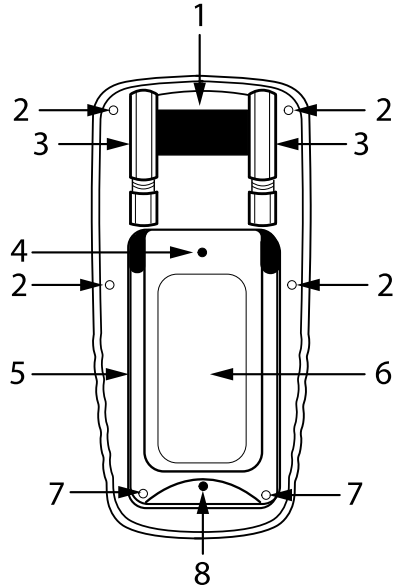





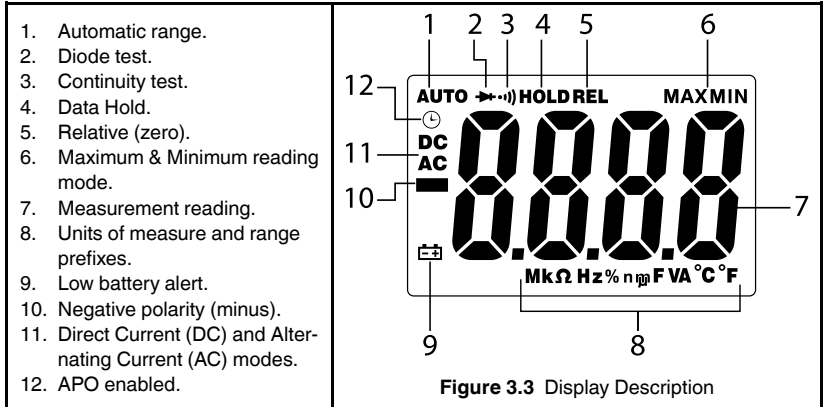

Figure 3.2 Meter Back.

3.3 Button Descriptions

	<p>Short press to select an alternate mode for the function in use.</p> <ul style="list-style-type: none"> • Select DC or AC in the voltage and current modes. • Select resistance, diode, continuity, or capacitance. • Select °C or °F in the Temperature mode.
	<p>Data Hold button: Short press to freeze/unfreeze reading.</p> <p>LCD backlight button: Long press to switch the backlight on or off. The backlight switches off automatically after 5 minutes.</p>
	<p>Short press to switch to the manual range, and then to step through the available ranges. Long press to return to the Auto range mode.</p>
	<p>Maximum and Minimum Readings: Short press to toggle the MAX and MIN measurements. Long press again to exit the mode.</p>
	<p>Relative (zero) button: Press to store the reading as a reference. Subsequent readings will subtract the reference from the displayed reading.</p>
	<p>Frequency and Duty Cycle button: When measuring AC current or voltage (function switch set to a voltage or current position), press this button to view the frequency of the measured signal. Press again to view the duty cycle, and press a third time to return to the voltage or current display.</p> <p>When measuring electronic frequency signals, set the function switch to Hz % and then use this button to toggle the frequency and duty cycle displays.</p>

3.4 Display Description



4 Meter Power

The meter is powered by one (1) 9 V battery. The battery compartment is located on the back of the meter (under the tilt stand) secured by the two black Phillips screws.

When the battery power is critically low, the battery icon appears. Replace the battery when this icon appears. See the Maintenance section for battery replacement instructions.

4.1 Automatic Power Off (APO)

To conserve battery life, the meter automatically switches off after approximately 15 minutes. To turn the meter on again, turn the function switch to the OFF position and then to the desired function position.

A quick succession of five beeper tones will sound when the meter is ready to switch off, press a button on the meter (**HOLD**, for example), to reset the APO timer.

To disable the APO, follow the steps below.

1. From the **OFF** position, hold the **MODE** button and rotate the function switch to a measurement position.
2. The meter will beep five times, release the **MODE** button.
3. APO is now disabled (APO icon switches off).
4. When the function switch is turned to the **OFF** position, APO is again enabled (default).

5 Operation

NOTE

Read and understand all Warning and Caution statements in this user manual prior to use. Set the function switch to the OFF position when the meter is not in use.

On some low AC and DC voltage ranges, with the test leads not connected to a device under test, the display may show a random, changing reading. This is normal and is caused by the high input sensitivity. The reading will stabilize and give a proper measurement when connected to a circuit.

	WARNING
Risk of electrocution. High-voltage AC and DC circuits are extremely dangerous and should be measured with great care.	

	CAUTION
<ul style="list-style-type: none">• ALWAYS turn the function switch to the OFF position when the meter is not in use.• If OL appears on the display during a measurement, the reading exceeds the selected range; change to a higher range.	

5.1 Automatic and Manual Range

In the current, voltage, resistance, and capacitance modes, the meter automatically selects the optimum range. To use manual range instead, follow the steps below.

1. Press the **RANGE** button. The **AUTO** display icon will switch off.
2. Now use the **RANGE** button to step through the available ranges.
3. To return to the automatic mode, long press the **RANGE** key, the **AUTO** icon will reappear.

5.2 MODE Button

The MODE button allows you to select an alternate unit of measure or function, as listed below.

- Select DC or AC in the voltage and current modes.
- Select resistance, diode, continuity, or capacitance.
- Select °C or °F in the Temperature mode.

5.3 LCD Backlight

The LCD is equipped with backlighting for easier viewing, especially in dimly lit areas. Long press the backlight button  to switch the backlight on or off. The backlight automatically switches off after 5 minutes.

5.4 Maximum and Minimum Readings

	CAUTION
When using the MAX/MIN function in Auto Range mode, the range that is active when the MAX/MIN button is pressed will be locked. If a MAX/MIN reading exceeds that range, OL will appear on the display. Select the desired range before entering MAX/MIN mode.	

1. Press the **MAX/MIN** button to toggle the maximum and minimum reading displays. The **MAX** and **MIN** display icons show the selected mode. In these modes, the display will only update when a higher (MAX) or lower (MIN) reading is measured.
2. Long press the **MAX/MIN** button to return to the normal mode of operation.

5.5 Relative (REL) Mode

The Relative (zero) feature allows you to make measurements relative to a stored reference value. In other words, a reference voltage, current, etc. can be stored, and subsequent measurements can be made in comparison to that value. The displayed value is the difference between the reference and the measured value.

The Relative function does not operate in the Frequency measurement mode.

1. Take a measurement as described in the operating instructions.
2. Press the **REL** button to store the reading, the **REL** indicator will appear on the display.
3. The display will now indicate the difference between the stored value and the measured value.
4. Press the **REL** button to exit the relative mode.

5.6 Data Hold

To freeze the displayed reading, press the **HOLD** button, the **HOLD** icon will appear. Press the **HOLD** button to return to normal operation.

5.7 AC/DC Voltage (Frequency, Duty Cycle) Measurements



CAUTION

Do not measure voltage if a motor on the circuit is being switched on or off. Large voltage surges may occur that can damage the meter.



WARNING

Some test lead probe tips may not be long enough to reach the live parts inside some voltage outlets (especially 240 V outlets) because the contacts are recessed deep in the outlets. As a result, the reading may show zero (0) volts when the outlet is actually live and has voltage present.

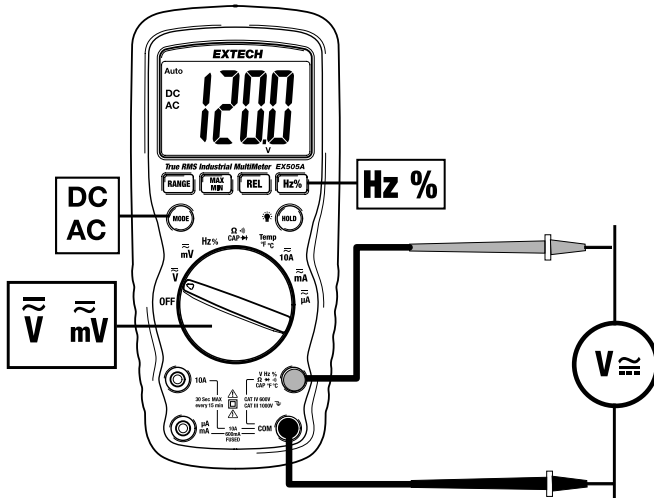

Figure 5.1 AC/DC Voltage measurement setup.

1. Rotate the function switch to one of the voltage positions (**V**, **mV**).
2. Press the **MODE** button to select AC or DC voltage.
3. Insert the black test lead plug into the negative **COM** jack. Insert the red test lead plug into the positive **V** jack.
4. Touch the black test probe tip to the negative side of the circuit. Touch the red test probe tip to the positive side of the circuit.
5. Read the voltage value on the display.

5.7.1 Frequency and Duty Cycle of AC Voltage Measurements

When measuring AC voltage, press the **Hz %** button to show the frequency (Hz), press again to show the duty cycle % of the measurement, and press a third time to return to the normal AC voltage display.

5.8 10 A AC/DC Current Measurements



WARNING

Do not make 10 A current measurements for longer than 30 seconds. Exceeding 30 seconds may cause damage to the meter and/or the test leads.

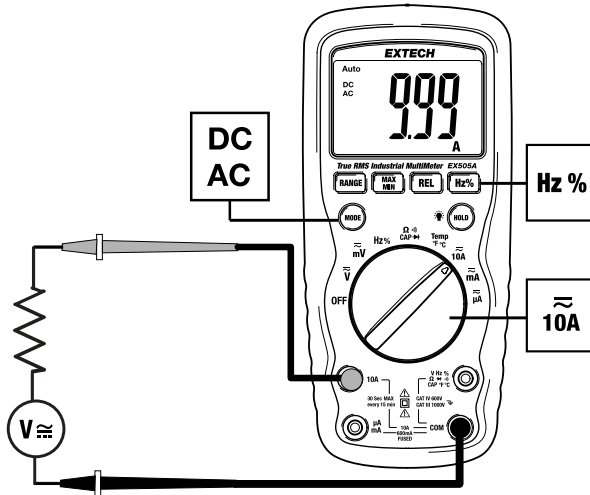

Figure 5.2 10 A AC/DC Current measurement setup.

1. Remove power to the circuit under test.
2. Rotate the meter's function switch to the **10A** position.
3. Insert the black test lead plug into the **COM** test lead jack.
4. Insert the red test lead plug into the **10A** test lead jack.
5. Place the test lead tips in series with the circuit under test.
6. Switch on power to the circuit under test.
7. Read the current value in the display.

5.8.1 Frequency and Duty Cycle of 10 A AC Current Measurements

When measuring in the 10 A AC current range, press the **Hz %** button to show the frequency (Hz), press again to show the Duty Cycle % of the measurement, and press a third time to return to the normal AC current display.

5.9 μA , mA AC/DC Current Measurements



WARNING

For current measurements up to 6000 μA , set the function switch to the **μA** position and insert the red test lead banana plug into the $\mu\text{A}/\text{mA}$ jack.

For current measurements up to 600 mA, set the function switch to the **mA** position and insert the red test lead banana plug into the $\mu\text{A}/\text{mA}$ jack.

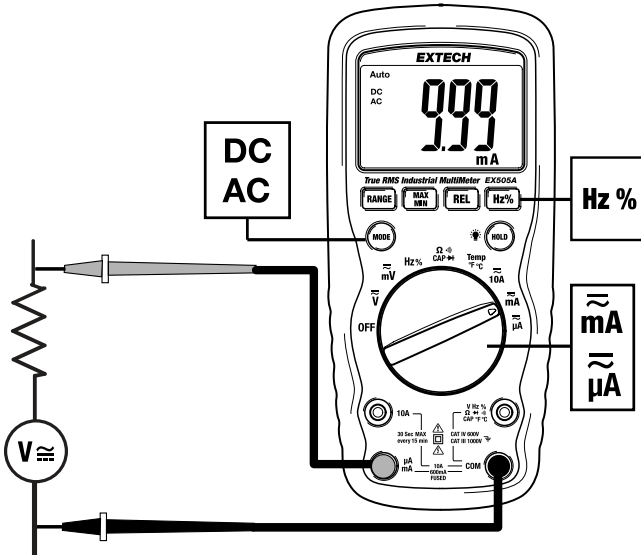

Figure 5.3 μA and mA AC/DC Current measurement setup.

1. Remove power to the circuit under test.
2. Rotate the meter's function switch to the **μA** or **mA** positions.
3. Insert the black test lead plug into the **COM** test lead jack.
4. Insert the red test lead plug into the **mA/μA** test lead jack.
5. Place the test lead tips in series with the circuit under test.
6. Switch on power to the circuit under test.
7. Read the current value in the display.

5.9.1 Frequency and Duty Cycle of μ A and mA AC Current Measurements

When measuring in the μ A and mA AC current ranges, press the **Hz %** button to show the frequency (Hz), press again to show the duty cycle % of the measurement, and press a third time to return to the normal AC current display.

5.10 Resistance Measurements



WARNING

To avoid electric shock, disconnect power to the unit under test and discharge all capacitors before taking resistance measurements.

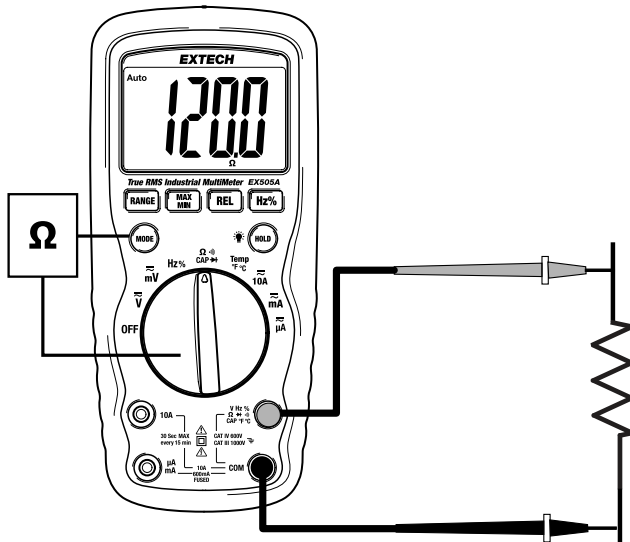

Figure 5.4 Resistance measurement setup.

1. Set the function switch to the Ω position.
2. If the resistance mode is not selected, use the **MODE** button to select it.
3. Insert the black test lead plug into the negative **COM** jack. Insert the red test lead plug into the positive Ω jack.
4. Touch the black test probe tip to one side of the device. Touch the red test probe tip to the other side of the device.
5. Read the resistance value in the display.

5.11 Continuity Test



WARNING

To avoid electric shock, never measure continuity on circuits or wires that have voltage present.

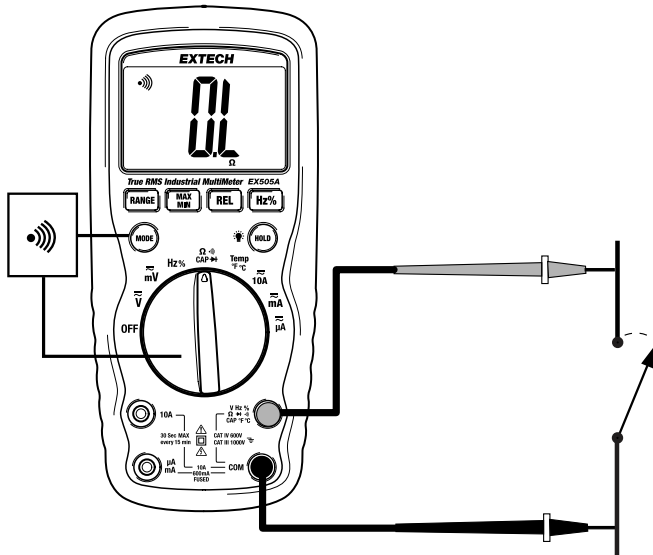



Figure 5.5 Continuity test setup. In the figure, the circuit is open, so the display shows OL. If the switch is closed, the circuit will short and a steady tone will sound.

1. Set the function switch to the  position.
2. Press the **MODE** button to select the continuity mode.
3. Insert the black test lead plug into the negative **COM** jack. Insert the red test lead plug into the positive  jack.
4. Touch the test probe tips across the circuit or component under test.
5. View the resistance measurement on the display.
6. If the resistance is $< 50 \Omega$ (approximately), a steady tone will sound.
7. If the circuit is open, **OL** will display.

5.12 Diode Test



WARNING

To avoid electric shock, never perform diode tests on components or circuits that have voltage present.

NOTE

The value indicated on the display during diode tests is the forward bias voltage.

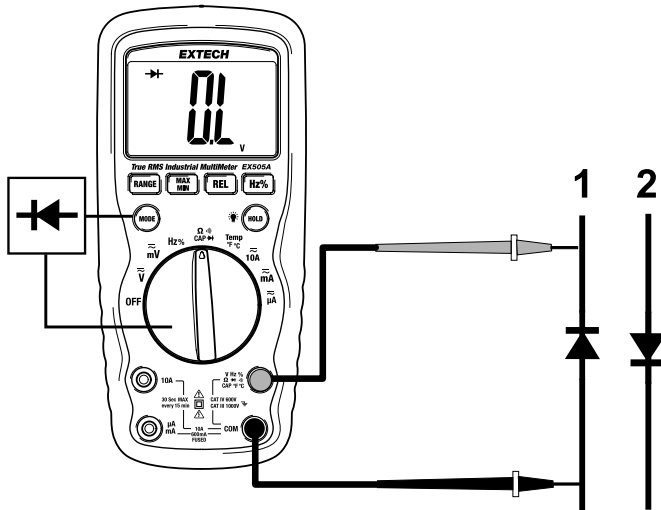

Figure 5.6 Diode test setup. Take a measurement in both positions (1 and 2) as shown in the figure. Follow the instructions in this section to interpret the test results.

1. Set the function switch to the $\rightarrow|$ position.
2. Press the **MODE** button to select the diode test mode.
3. Insert the black test lead plug into the negative **COM** jack. Insert the red test lead plug into the positive $\rightarrow|$ jack.
4. Touch the test probe tips across the diode or semiconductor junction under test. Note the meter reading.
5. Reverse polarity by swapping the red and black test lead tip placements. Note this reading.

6. The diode or junction can be evaluated as follows.
- If one reading is between 0.400 V and 0.700 V, and the other reading is **OL**, then the diode is good.
 - If both readings are **OL** the device is bad (open).
 - If both readings are very low or zero, the device is bad (shorted).

5.13 Capacitance Measurements



WARNING

To avoid electric shock, disconnect power to the unit under test and discharge all capacitors before taking capacitance measurements.

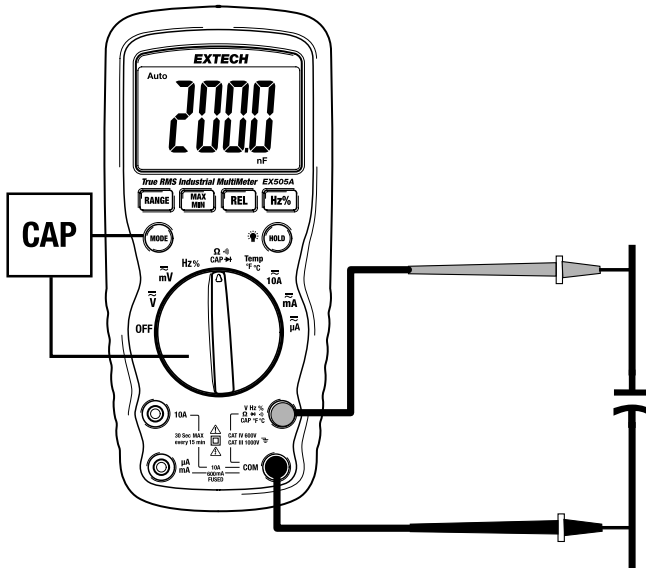

Figure 5.7 Capacitance test setup.

1. Rotate the function switch to the capacitance position nF .
2. Use the **MODE** button to select the capacitance function.
3. Insert the black test lead plug into the negative **COM** jack. Insert the red test lead plug into the positive nF jack.
4. Touch the black test probe tip to one side of the device. Touch the red test probe tip to the other side of the device.
5. Read the capacitance value in the display.



CAUTION

For large capacitors, allow sufficient time for readings to stabilize.

5.14 Frequency and Duty Cycle Measurements (Electronic)



WARNING

This section applies to low voltage electronic frequency measurements. To measure high voltage frequency and duty cycle, refer to Section 5.7, *Voltage Measurements*, above.

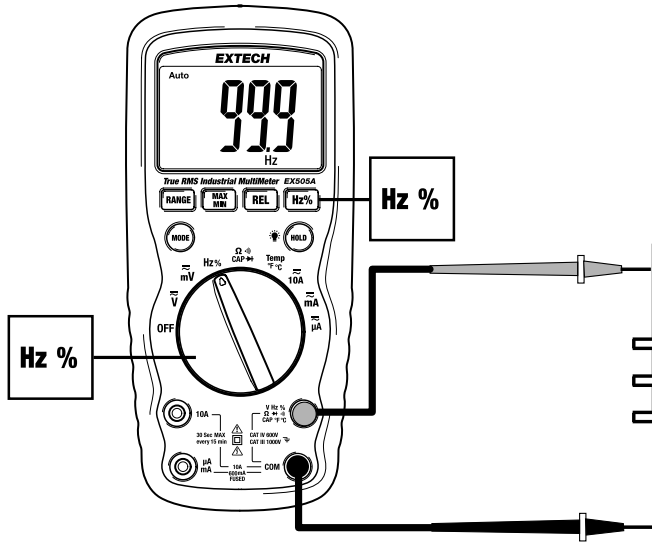

Figure 5.8 Frequency test setup.

1. Rotate the function switch to the **Hz %** position
2. Insert the black test lead plug into the negative **COM** jack. Insert the red test lead plug into the positive **Hz %** jack.
3. Touch the black test probe tip to one side of the component or circuit. Touch the red test probe tip to the other side.
4. Read the measurement value on the display.
5. Use the **MODE** button to toggle frequency and duty cycle functions.

5.15 Type K Thermocouple Temperature Measurements



CAUTION

The supplied thermocouple is rated for 482°F (250°C) maximum. If a higher temperature range is needed, acquire a suitably rated thermocouple. If a higher temperature is measured with the supplied probe, damage to the thermocouple and meter is possible.

For an open input, the meter will display dashes. For temperature over-range, the meter will display **OL**.

NOTE

The temperature probe is fitted with a type K mini connector. A mini connector to banana connector adaptor is supplied for connection to the input banana jacks.

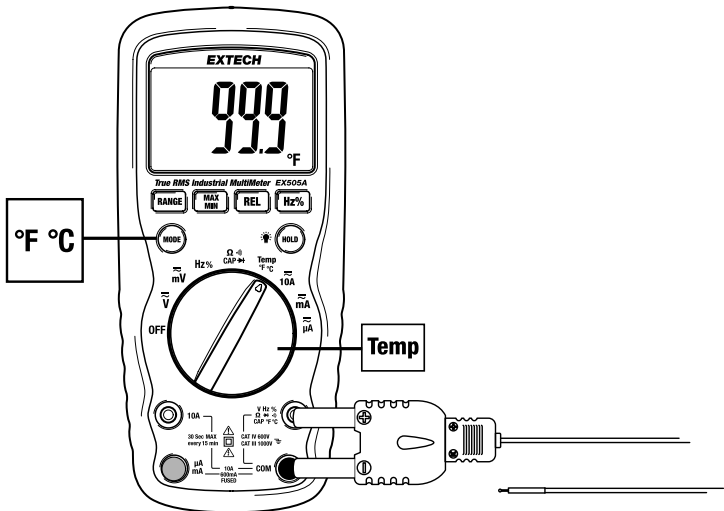

Figure 5.9 Thermocouple temperature test setup.

1. Rotate the function switch to the **TEMP** position.
2. Press the **MODE** button to select °F or °C.
3. Insert the temperature probe into the test lead jacks, observing correct polarity.
4. Touch the temperature probe tip to the surface under test.
5. Read the temperature measurement on the display.

6 Maintenance



CAUTION

To avoid electrical shock, disconnect the meter from the circuit under test, remove the test leads from the input terminals, and turn the function switch to the OFF position, before opening the case. Do not operate the meter with an open case.

Keep the meter dry. If it gets wet, wipe it off.

Use and store the meter in normal ambient conditions. Temperature extremes can shorten the life of the electronic parts and distort or melt plastic parts.

Handle the meter gently and carefully. Dropping it can damage the electronic parts or the case.

Use only fresh batteries, of the recommended size and type. Remove old or weak batteries so they do not leak and damage the unit.

6.1 Cleaning and Storage

Periodically wipe the case with a damp cloth and mild detergent; do not use abrasives or solvents. If the meter is not to be used for > 60 days, remove the battery and store it separately.

6.2 Battery Replacement



WARNING

To avoid electric shock, disconnect the test leads from any source of voltage before opening the meter.

Remove the test leads from the meter before replacing the battery or fuses.

Expired or damaged batteries can cause cauterization on contact with the skin. Always use suitable hand protection when handling such batteries.

Never operate the meter unless the back cover and the battery and fuse covers are in place and fastened securely.

Do not short circuit the battery and do not dispose of the battery in a fire.

Remove the batteries when storing the meter for > 60 days.

1. Disconnect the test leads from the meter.
2. Remove the battery door by loosening the two Phillips head screws. The two battery compartment screws are black in colour, as shown in Section 3, *Product Description*. One is visible at the centre of the meter back, the other is accessible after lifting the tilt stand.
3. Replace the battery, observing correct polarity.
4. Secure the battery compartment before using the meter.

6.3 Fuse Replacement

**WARNING**

To avoid electric shock, disconnect the test leads from any source of voltage before opening the meter.

Remove the test leads from the meter before replacing the battery or fuses.

Never operate the meter unless the back cover and the battery and fuse covers are in place and fastened securely.

1. Disconnect the test leads from the meter and from the device under test.
2. Access the fuses by opening the meter back, which is secured by six Phillips screws, silver in colour (see Section 3, *Product Description*). Four of the screws are visible, and two are hidden by the tilt stand, as shown in Section 3. Lift the tilt stand to access them.
3. Remove the old fuse by gently pulling and extracting it from its holder. Install the new fuse into the holder. Always use a fuse of the proper size and value (600mA/1000V fast blow for the 600mA range, 10A/1000V fast blow for the 10A range).
4. Secure the meter housing before using the meter.

7 Specifications

7.1 General Specifications

Enclosure	Double moulded waterproof housing. IP67 rated, tested by Bureau Veritas (BV)
Display	6000 count (3–5/6 digits) backlit LCD with multifunction indicators
Over-range indication	OL display
Measurement rate	3 readings per second, nominal
Battery power	One (1) 9 V battery (NEDA 1604 IEC 6F22)
Low battery indication	Battery symbol  is displayed
Auto Power Off (APO)	After approximately 15 minutes of inactivity
Operating temperature	32 to 122°F (0 to 50°C)
Operating humidity	< 70% RH
Storage temperature	-4° to 140°F (-20 to 60°C)
Storage humidity	< 80% RH
Operating altitude	7000 ft. (2000 m) maximum
Dimensions	7.1 x 3.2 x 2.2 in. (183 x 83 x 55 mm)
Weight	0.8 lbs. (365 g)
Safety	<p>Meter: Over-voltage Category IV 600 V, Category III 1000 V, Pollution Degree 2.</p> <p>Supplied test leads: Over-voltage Category IV 600 V, Category III 1000 V, 10 A min., UL Listed.</p> <p>UL 61010-1 - Edition 3 - Issue Date 2012/05/11-Revision Date 2019 July 19.</p> <p>CAN/CSA-C22.2 No.61010-1-12-Edition3- Issue Date 2012/05/11-Revision Date 2019 /07/19 to Category IV 600V and Category III 1000V; Pollution Degree 2.</p> <p>UL 61010-2-033 Second Edition, Issue Date January 10, 2020.</p> <p>CSA C22.2 No.61010-2-033:20, Issue Date 08/2020.</p>
Agency approvals	UL, CE, UKCA

7.2 Electrical Specifications

Fuse types	600 mA (1000 V) fast blow for the 600 mA range. 10 A (1000 V) fast blow for the 10 A range.
Input impedance	10 M Ω (Voltage AC/DC)
AC bandwidth	50 to 1000 Hz (AC voltage); 50/60 Hz (AC current)
AC response	True RMS (AC voltage and current)
Crest Factor 50/60 Hz	≤ 3.0 at full scale up to 500 V decreasing linearly to ≤ 1.5 at 1000 V
Supplied Thermocouple	Type K; rated 482°F (250°C) maximum. Exceeding these temperature limits will damage the probe and/or meter.

7.3 Measurement Specifications

Function	Range	Resolution	Accuracy (% of reading + digits)
DC Voltage (Auto Range)	60.00 mV	0.01 mV	$\pm(0.9\% + 9 \text{ digits})$
	600.0 mV	0.1 mV	
	6.000 V	0.001 V	
	60.00 V	0.01 V	$\pm(0.6\% + 6 \text{ digits})$
	600.0 V	0.1 V	
	1000 V	1.0 V	
Notes: Maximum input 1000 V.			
AC Voltage (Auto Range)	60.00 mV	0.01 mV	$\pm(0.9\% + 9 \text{ digits})$
	600.0 mV	0.1 mV	$\pm(0.8\% + 3 \text{ digits})$
	6.000 V	0.001 V	
	60.00 V	0.01 V	
	600.0 V	0.1 V	$\pm(0.8\% + 8 \text{ digits})$
	1000 V	1.0 V	
Notes: All AC voltage ranges are specified from 5 to 100% of range. AC V bandwidth: 50 Hz to 1 kHz (sine) or 50/60 Hz (all waveforms). Maximum input: 1000 V.			

DC Current (Auto Range)	600.0 μ A	0.1 μ A	$\pm(1.0\% + 3 \text{ digits})$
	6000 μ A	1.0 μ A	
	60.00 mA	0.01 mA	
	600.0 mA	0.1 mA	
	6.000 A	0.001 A	$\pm(1.5\% + 3 \text{ digits})$
	10.00 A	0.01 A	
<p>Notes: Overload protection: 600 mA / 1000 V and 10 A / 1000 V fused.</p> <p>Maximum input: 600 mA DC or AC RMS on μA/mA ranges.</p> <p>10 A DC or AC RMS on 10 A range for 30 seconds maximum with reduced accuracy.</p>			
AC Current (Auto Range)	600.0 μ A	0.1 μ A	$\pm(1.5\% + 3 \text{ digits})$
	6000 μ A	1.0 μ A	
	60.00 mA	0.01 mA	
	600.0 mA	0.1 mA	
	6.000 A	0.001 A	$\pm(2.0\% + 3 \text{ digits})$
	10.00 A	0.01 A	
<p>Notes: Overload protection: 600 mA / 1000 V and 10 A / 1000 V fused.</p> <p>Maximum input: 600 mA DC or AC RMS on μA/mA ranges.</p> <p>10 A DC or AC RMS on 10 A range for 30 seconds maximum with reduced accuracy.</p> <p>All AC current ranges are specified from 5 to 100% of range.</p> <p>AC current bandwidth: 50 to 1 kHz (sine) or 50/60 Hz (all waveforms).</p>			
Resistance (Auto Range)	600.0 Ω	0.1 Ω	$\pm(1.0\% + 2 \text{ digits})$
	6.000 k Ω	0.001 k Ω	$\pm(0.8\% + 2 \text{ digits})$
	60.00k Ω	0.01 k Ω	
	600.0 k Ω	0.1 k Ω	
	6.000 M Ω	0.001 M Ω	$\pm(1.2\% + 2 \text{ digits})$
	60.00 M Ω	0.01 M Ω	$\pm(1.0\% + 5 \text{ digits})$

Capacitance	60.00 nF	0.01 nF	±(5.0% + 20 digits)
	600.0 nF	0.1 nF	±(4.0% + 5 digits)
	6.000 µF	0.001 µF	
	60.00 µF	0.01 µF	
	600.0 µF	0.1 µF	
	6.000 mF	0.001 mF	±(10.0% of reading)
	60.00 mF	0.01 mF	
	99.99 mF	0.01 mF	
Notes: < 99.99 nF is not specified.			
Frequency (Electronic)	9.999 Hz	0.001 Hz	±(1.0% + 5 digits)
	99.99 Hz	0.01 Hz	
	999.9 Hz	0.1 Hz	
	9.999 kHz	0.001 kHz	
	99.99 kHz	0.01 kHz	
	999.9 kHz	0.1 kHz	
	9.999 MHz	0.001 MHz	
Notes: Sensitivity: 0.8 V RMS minimum at 20 to 80% duty cycle and < 100 kHz; 5 V RMS minimum at 20 to 80% duty cycle and < 100 kHz.			
Frequency (Electrical)	10.00 to 1 kHz	0.01 Hz	± (0.5 % of reading)
	Sensitivity: AC mV range (≥ 100 mV). AC V range (≥ 6% of range). 6000µA / 600.0mA / 10.00A ranges (≥ 6% of range). 600.0µA / 60.00mA / 6.000A ranges (≥ 60% of range).		
Duty Cycle	0.1 to 99.9%	0.1%	± (1.2 % + 2 digits)
	Pulse width: 100 µS to 100 ms (frequency: 5 Hz to 150 kHz)		

Temperature (Type K)	-20 to 760°C (-4 to 1400°F)	1.0°	± (3.0 % + 5°C [9°F]) Probe accuracy not included
	The supplied thermocouple is rated for 482°F (250°C) maximum. If a higher temperature range is needed, acquire a suitably rated thermocouple. If a higher temperature is measured with the supplied probe, damage to the thermocouple and meter is possible.		
Diode test	Test current: 1.5 mA max.	0.001 V	± (10.0% + 5 digits)
	Open circuit voltage: 3.2 V DC typical.		
Continuity	Audible threshold: < 50 Ω.		
	Test current: < 0.35 mA.		

8 Customer Support

Customer Support Local Telephone List:

<https://support.flir.com/contact>

Returns (RMA):

<https://customer.flir.com/Home>

9 Warranty

Teledyne FLIR warrants this Extech brand instrument to be free of defects in parts and workmanship for three years from date of shipment. To view the full warranty text, please visit the support site, link below.

<https://www.flir.com/support-center/warranty/>

Manufacturer Address:

Teledyne FLIR Commercial Systems, Inc.

10F, No. 57, Zhouzi Street, NeiHu District

Taipei City, 114676, Taiwan

Website

<http://www.flir.com>

Customer support

<http://support.flir.com>

Copyright

© 2024, FLIR Systems, Inc. All rights reserved worldwide.

Disclaimer

Specifications subject to change without further notice. Models and accessories subject to regional market considerations. License procedures may apply. Products described herein may be subject to US Export Regulations. Please refer to exportquestions@flir.com with any questions.

Publ. No.: NAS100177
Release: AE
Commit: 98161
Head: 98225
Language: en-US
Modified: 2024-06-04
Formatted: 2024-06-04

