

EXTECH[®]

User Manual

Wireless Articulating Borescope

MODEL BR450W-A2

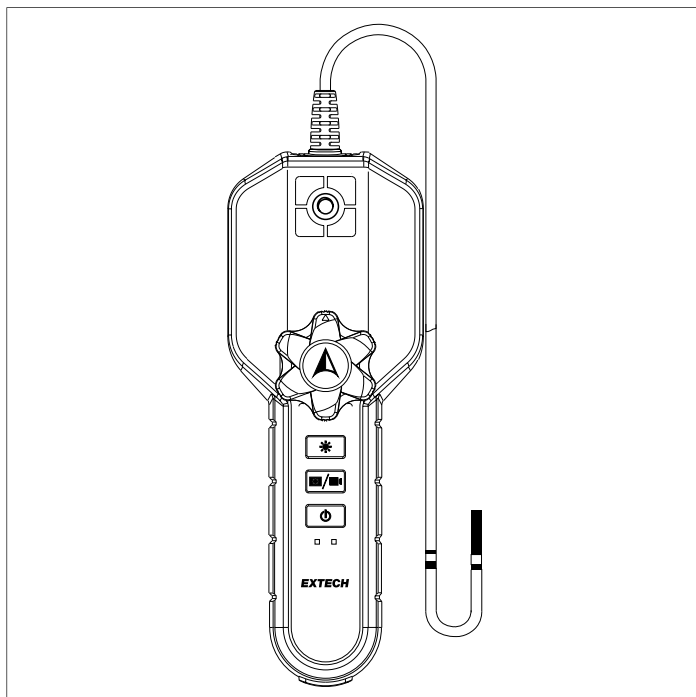

Introduction

Thank you for selecting the Extech Wireless Articulating Borescope. This device offers a forward viewing camera mounted on a flexible cable for easy insertion in pipes, ducts, etc. The camera lens includes adjustable LED lights for viewing in dark and dimly lit areas.

The flexible cable has an articulating neck that you control from the dial on the main unit in a radius of 180°.

The camera view is monitored on a mobile device, on a Wi-Fi network, using the ExView® app. A mobile device can be attached to the Borescope using the supplied accessory. Images and video can be recorded on the mobile device and easily shared.

Safety

To ensure safety, read the following statements carefully before using this device. If the equipment is used in a manner not specified by the manufacturer, the protection provided by the equipment may be impaired.

 WARNING
Risk of injury or loss of life if this product is used without heeding the published warnings. For industrial commercial use only.

 WARNING
Do not use this system in environments where this is a risk of explosion. Do not use this system near flammable gas.

 WARNING
The lighting produced by this device can cause eye injury if observed directly.

 WARNING
Replacing the battery with a type that is not recommended by the manufacture can cause an explosion.

 CAUTION
Failure to heed the caution statements in this document can result in damage to the device.

 CAUTION
These liquids are safe for probe submersion: water, brake fluid, gasoline, diesel fuel, and transmission fluid. Do not submerge in any other liquid.

CE NOTICE

This system is in conformance with the 2014/53/EU Electromagnetic Compatibility Directive standard.

RoHS NOTICE

This system is in conformance with the requirements of the European law on the Restriction of Hazardous Substances (RoHS) directive. This means that our product is both lead-free and without the hazardous substances either in the manufacturing process or in the final product.

FCC NOTICE

This device complies with Part 15 of the FCC Rules. Operation is subject to the following two conditions: (1) This device may not cause harmful interference. (2) This device must accept any interference received, including interference that may cause undesired operation.

NOTE: This equipment has been tested and found to comply with the limits for a Class B digital device, pursuant to Part 15 of the FCC Rules. These limits are designed to provide reasonable protection against harmful interference in a residential installation. This equipment generates uses and can radiate radio frequency energy and, if not installed and used in accordance with the instructions, may cause harmful interference to radio communications. However, there is no guarantee that interference will not occur in a particular installation. If this equipment does cause harmful interference to radio or television reception, which can be determined by turning the equipment off and on, the user is encouraged to try to correct the interference by one or more of the following measures:

- Reorient or relocate the receiving antenna.
- Increase the separation between the equipment and receiver.
- Connect the equipment into an outlet on a circuit different from that to which the receiver is connected.
- Consult the dealer or an experienced radio/TV technician for help.



WARNING

Changes or modifications not expressly approved by the party responsible for compliance could void the user's authority to operate the equipment.

SAR Warning Statement

This device meets the government's requirements for exposure to radio waves. This device is designed and manufactured not to exceed the emission limits for exposure to radio frequency (RF) energy set by the Federal Communications Commission of the U.S. Government. The exposure standard employs a unit of measurement known as the Specific Absorption Rate, or SAR. The SAR limit set by the FCC is 1.6 W/kg. Tests for SAR are conducted using standard operating positions accepted by the FCC with the EUT transmitting at the specified power level in different channels. The highest SAR value for the device as reported to the FCC is 0.68 W/kg when placed next to the body or on hand with a minimum of 0 mm separation from the body.



Product Description

Overview

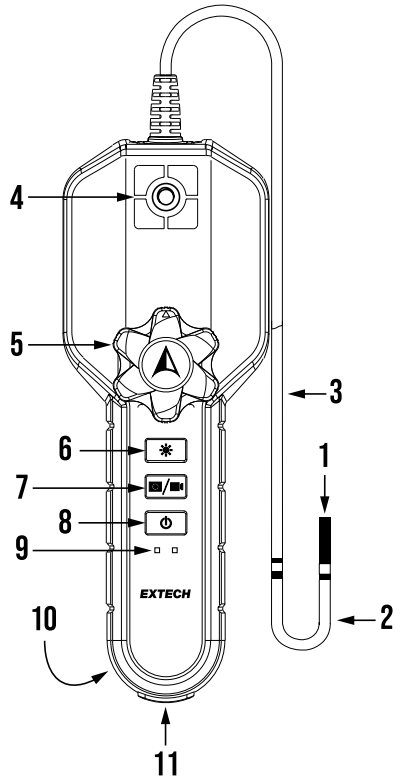
1. Camera lens
2. Articulating neck
3. Flexible cable
4. Mount for mobile device (supplied accessory)
5. Articulation control dial
6. Camera light brightness button
7. Image and Video capture button
8. Power button (short press ON, long press OFF)
9. Battery (left) and Wi-Fi (right) status indicators
10. Battery compartment on back
11. USB-C charging port (supplied cable)



Control Buttons

Camera brightness adjustment button. Short press to step through five (5) intensity levels and OFF.	
Image and Video Capture. Short press to capture an image. Long press to start video recording, short press to stop video recording.	
Power button. Long press to switch the device ON or OFF. The APO timer switches the device OFF after five minutes of inactivity. To adjust the APO timer, use the Settings menu in the ExView app.	

Articulation Dial

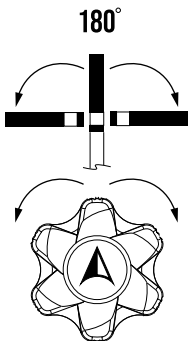

The articulation dial allows you to remotely bend the probe's articulation neck in a 180° radius. Turn the dial to the left or right to move the camera head accordingly. The arrows printed on the dial indicate the direction the camera is facing.

Do not force the dial left or right once you feel resistance.

LED Indicators

The two LED indicators, below the control buttons, show battery status (on left) and Wi-Fi connection status (on right). Refer to the table below for battery and Wi-Fi status.

Condition	Battery LED (left)	Wi-Fi LED (right)
100% charged, not connected to Wi-Fi network	Solid Green	Blinking Green
100% charged, connected to Wi-Fi network	Solid Green	Solid Green
Battery charging, not connected to Wi-Fi network	Solid Red	Blinking Green
Battery charging, connected to Wi-Fi network	Solid Red	Solid Green
Low battery	Blinking Red	n/a

Mobile Device Attachment Accessory

The Borescope system includes an accessory for attaching a mobile device to the control unit. The side of the accessory with the fixed washer, screws into the mounting hole on the Borescope control unit.

The side of the accessory with the moveable washer, attaches to a mobile device bracket (not supplied). The handle on the accessory allows you to easily loosen, tighten, and position the accessory. Do not overtighten.

Operation

Quick Steps

1. Download the ExView app to your mobile device from Google Play™ (Android™) or the App Store® (iOS®).
2. Long press the power button to switch the Borescope ON, the LED indicators will switch ON.
3. From the list of available Wi-Fi networks on your mobile device, select the BR450W. If you do not perform this step before the APO timer elapses, the Borescope will automatically switch OFF. In this case, switch ON the Borescope and continue.
4. The password is **1234567890**
5. Open the ExView app on your mobile device. Refer to the ExView app information, below, and in the app.
6. To switch the Borescope OFF, long press the power button. When you release the button, the LED lamps will switch off.
7. The Borescope camera probe can be safely submersed in the liquids listed in the Safety section of this manual. The camera can be submersed to a depth of 3.3 ft. (1 m), maximum, for limited periods. Never submerge the control unit in liquid or expose it to rain or excessive moisture.
8. Keep the probe's articulation neck as straight as possible when moving it through the inspection area. When you have reached the desired probe depth in the inspection area, turn the articulation dial left or right, to rotate the camera view in a 180° radius. Do not rotate the dial excessively. Stop rotating the control wheel when the neck reaches its maximum angle.

Operational Guidelines

- Always bend the articulating neck using the articulating dial, never bend the neck by hand. Do not rotate the dial excessively.
- Straighten the neck before removing it from the inspection area. If the camera becomes lodged in the inspection area, straighten the neck before trying to remove it.
- Never use the probe to clear pathways or clogged areas. Avoid probe impact.
- Approved liquids for probe submersion are listed in the Safety section. Do not allow the probe to contact acidic, corrosive, or hot materials. When inspecting a vehicle, shut the engine off first and allow it to cool.
- Never coil the probe cable to a diameter < 5.9 in. (15 cm). Before storing the probe, straighten the neck.

ExView Application

The app screen shot, below, provides a basic overview of the app icons and features. Refer to the ExView user manual for complete instructions. A link to the manual is provided in the app Settings menu, or navigate to the FLIR support site, directly from your web browser, to obtain a copy of the manual.

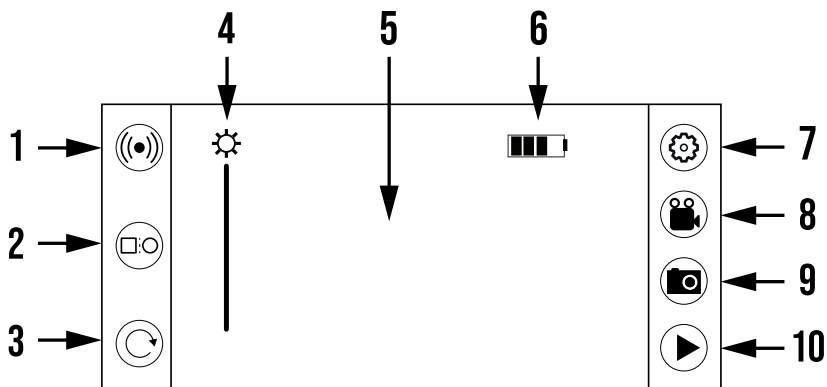

1. Switch to Bluetooth® mode
2. Select an image from the gallery, for a side-by-side comparison with the live camera image
3. Rotate the camera image
4. Adjust camera light brightness
5. Camera image
6. Borescope battery status
7. Settings menu
8. Start/Stop video recording
9. Capture camera image
10. Open image and video gallery

App Connection Troubleshooting

If the Borescope and app stop communicating, follow the steps below.

1. Switch OFF the Borescope
2. Close the ExView App
3. Switch ON the Borescope
4. Select the BR450W from the list of available Wi-Fi networks
5. Open the ExView app and try again
6. If issues persist, delete the app, completely, from your mobile device, and reinstall it. After reinstalling, repeat the steps above.

Rechargeable Battery

Battery Overview

The Borescope is shipped with a partially charged 3.7 V lithium ion battery. Fully charge the battery before use.

 WARNING
<ul style="list-style-type: none">• Remove the battery from the device before storing for extended periods.• If the battery needs replacing, use only a battery of the same type.• Do not use this device while the battery compartment is open.• To reduce the risk of explosion, do not place the battery near fire, compact it, or otherwise damage it.

 CAUTION
Operating the device with a low battery, or while charging, can cause the Wi-Fi feature to malfunction.

Battery Charging

 CAUTION
Do not charge the battery if the ambient temperature exceeds the specified operating temperature range.

1. Connect the supplied USB cable to the Borescope USB-C port (bottom).
2. Connect the other end to a 5 volt DC input  (3 A) charger.
3. The LED indicator on the left of the Borescope is solid red when charging. A complete charge requires 2 hours, typically. When the battery is fully charged, the LED will appear solid green.

Auto Power Off (APO)

To conserve battery energy, the Borescope switches off after five minutes of inactivity. To switch the APO feature off, or to change the APO time, use the app (Settings > Device Information > Auto Power Off).

Battery Replacement

The rechargeable lithium ion battery is accessible from the back of the device.

1. Remove the five (5) Phillips screws from the back of the device. The screw near the bottom is covered by a sticker.
2. Carefully open the device housing to access the battery compartment.
3. Remove the old battery and dispose of responsibly and in accordance with applicable laws and regulations.
4. Install the new battery, observing correct polarity. Use only a 3.7 V lithium ion battery (4900 mAh). Using a different battery type can cause fire or explosion.
5. Secure the device housing with the screws before use.

Specifications

Borescope	
Dimensions (control unit)	7.4 x 2.7 x 2.4 in. (187 x 67.8 x 60.5 mm)
Weight	12.9 oz. (365 g)
Image resolution/format	1280 x 720 pixels (JPG)
Video resolution/format	1280 x 720 pixels (AVI)
Battery	3.7 V (4900 mAh) lithium ion Battery life: 6 hours, maximum Charge time: 2 hours
Power source	5 Volts, 3 Amps (USB-C)
Wi-Fi	IEEE 802.11 b/g/n, 2.4Ghz
Antenna	Built-in
Transmission distance	98.4 ft. (10 m), maximum, with no obstruction
Operating temperature	32 to 113°F (0 to 45°C)
Drop protection	Probe: 4.9 ft. (1.5 m); Control unit: 3.3 ft. (1 m)
Certification	CE/FCC

Camera Probe	
Probe head diameter	3.9 mm
Probe head length	17 mm
Probe cable length	4.9 ft. (1.5 m)
Articulation angle	Two-way 180°
Probe head material	Stainless steel
Probe material	Outer braid, stainless steel
Light source	LED ring around camera lens
Field of View	90°
Depth of Field	10 to 100 mm
Operating and Storage temperature	14 to 140°F (-10 to 60°C)
Water proof	Camera only: IP67

Cleaning

Use clean water or mild liquid detergent and a swab (supplied) to clean the camera head after use. A lens cloth is also supplied. Do not use corrosive liquids, such as alcohol to clean the lens.

The control unit can be wiped with a damp cloth when necessary; never use solvents or abrasives.

Customer Support

Customer Support Local Telephone List:

<https://support.flir.com/contact>

Returns (RMA):

<https://customer.flir.com/Home>

Warranty

Teledyne FLIR warrants this Extech brand instrument to be free of defects in parts and workmanship for two years from date of shipment. To view the full warranty text, please visit the support site, link below.

<https://www.flir.com/support-center/warranty/>

Website

<http://www.flir.com>

Customer support

<http://support.flir.com>

Copyright

© 2024, FLIR Systems, Inc. All rights reserved worldwide.

Disclaimer

Specifications subject to change without further notice. Models and accessories subject to regional market considerations. License procedures may apply. Products described herein may be subject to US Export Regulations. Please refer to exportquestions@flir.com with any questions.

Publ. No.: NAS100204
Release: AB
Commit: 97511
Head: 97511
Language: en-US
Modified: 2024-05-03
Formatted: 2024-05-03

