

Bevel Protractor BP-301

This is a high reliable general purpose type precision protractor used widely in many countries in the world.

This popular protractor has been favored by many users because of their superior sense.

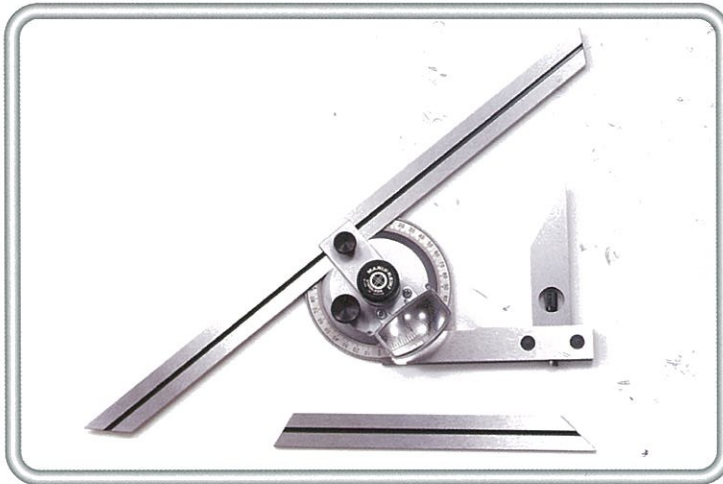

■ Features

- The main scale and vernier scale are flat to avoid the reading error due to step gap.
- Fine adjustment can be made by using the fine adjustment knob.
- Scale part is satin-chrome plated for easy reading with less reflection.
- Main parts are made of hardened stainless steel superior in rust-resistance and durability.
- Instrument error: $\pm 5'$

■ Specifications

Measurement range	-360° (0-90°x 4)
Minimum reading	5'
Instrument error	$\pm 5'$
Body material	Hardened stainless steel (SUS420J2)
Main unit weight	180g approx.
Accessories	150mm and 300mm blades, acute angle attachment

■ Main dimensions

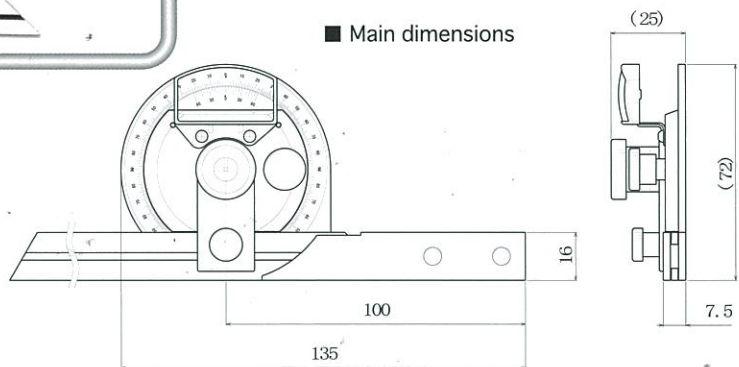

Bevel Protractor Heavy Duty Type BP-301ST

This is a high rigid, stable and accurate bevel protractor but heavy-duty type.

Thanks to high rigid body, this unit can be clamped by vices and etc.

In addition the stability is very high due to wide measuring surface (30mm).

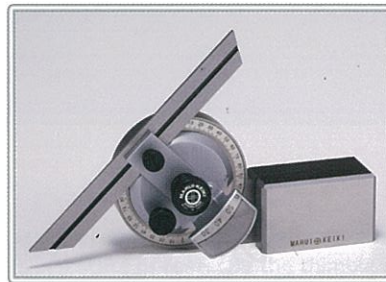

■ Specifications

Main unit weight	1050g approx.
Accessory	150mm blade

All other specifications are the same as for the BP-301.

Optional Accessories

Stand

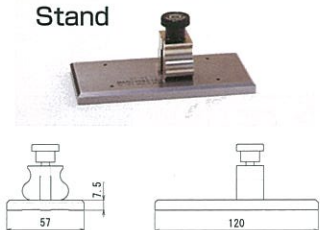

Acute angle attachment

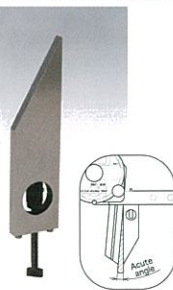

Height gauge holder

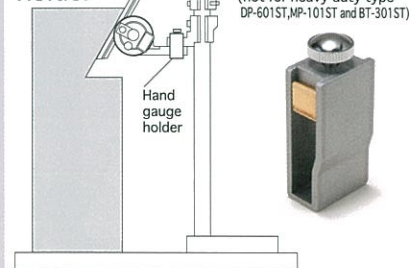

Square

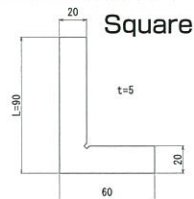

Blade

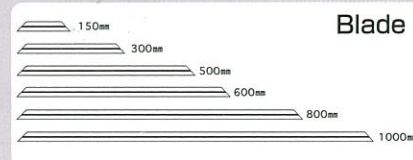

L-blade for horizontal angles (level)

