

# Self-cleaning Overhead Two Fans Ionizing Air Blower

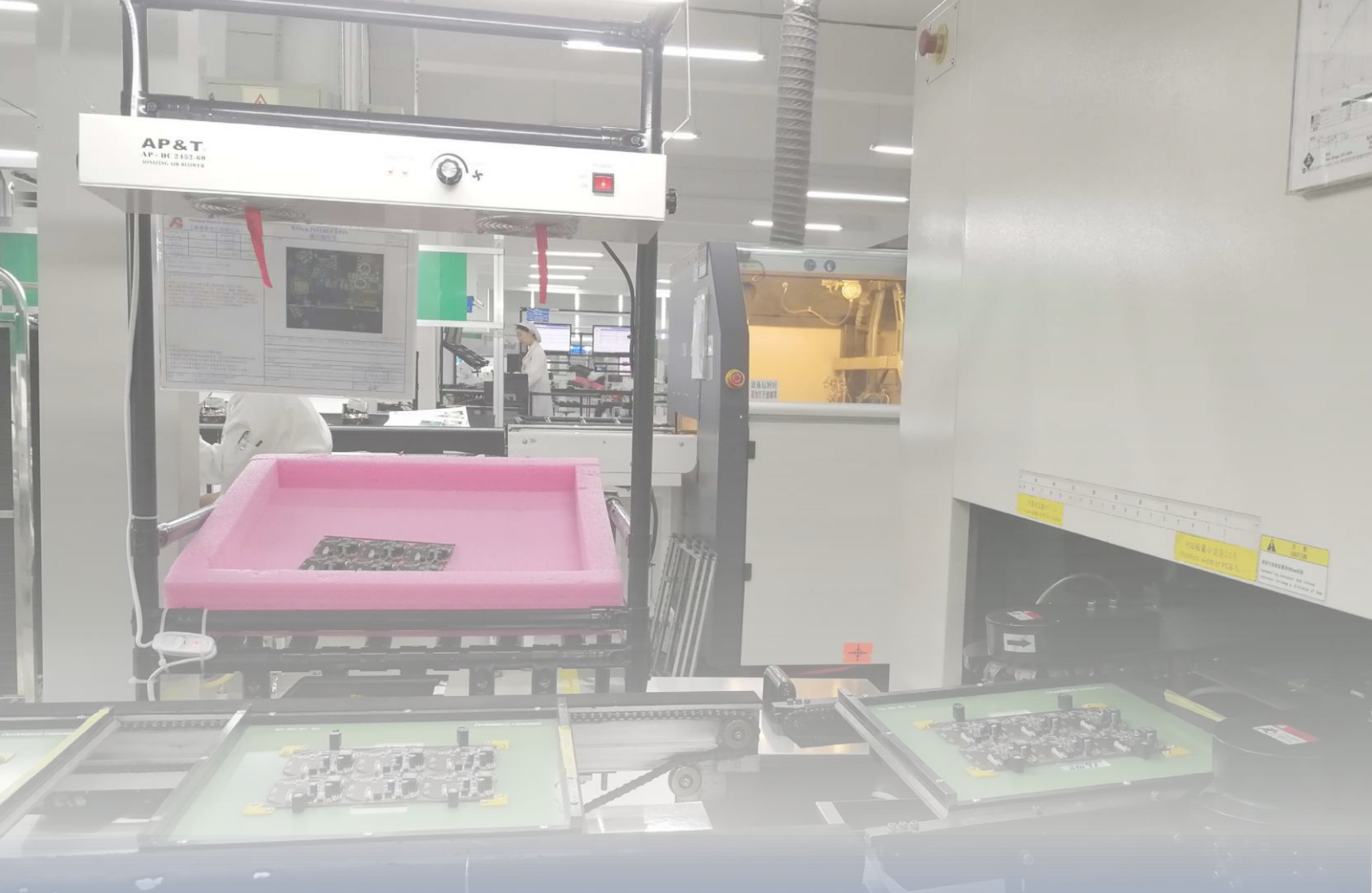



Suitable for electronics, optoelectronics,  
semiconductor and other industries

Effectively solve the problems  
caused by static electricity



Static removal

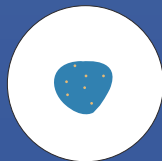

Prevent adhesion of objects

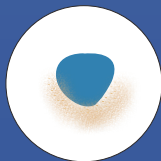

Prevent material splash

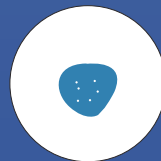

Prevent static electricity

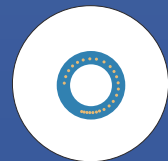

Prevent blockage of feeder



High efficient



Safe

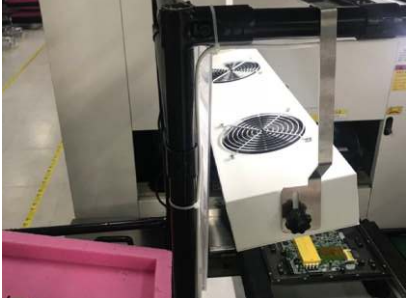

Static removal



# High Efficiency Static Removal

Keep a clean production environment and stay away from static electricity

## Discharge effect

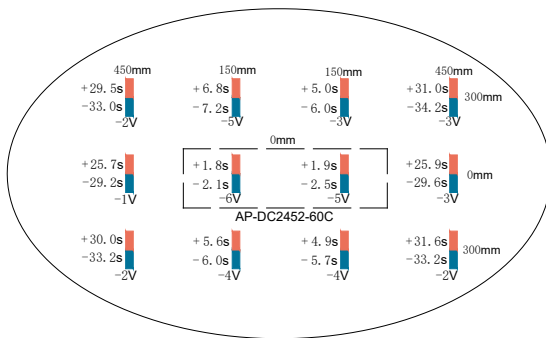

Test standard: ANSI/ESD.STM3.1, SJ/T 11446—2013

Test instrument: Trek 157 static tester

Test voltage:  $\pm 1000V \rightarrow \pm 100V$  attenuation

Test environment: humidity 50 $\pm$ 5%; temperature 23 $\pm$ 3 $^{\circ}C$

The test data as follows (test distance: 450mm in front, maximum air volume):

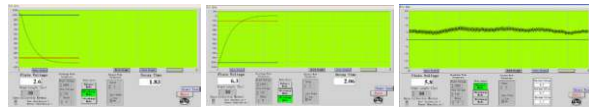

## Working way

AP-DC2452-60C ionizing air blower uses positive and negative synchronous emission electrodes to generate corona discharge through DC high voltage, ionize air molecules and generate a large number of positive and negative air ions, which are blown to the surface of the object with electrostatic to be eliminated by the fan.

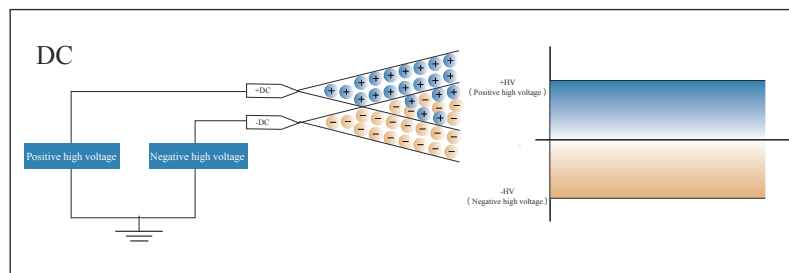

# Features

Safe / Easy to use / Durable



No.1

## Automatic needle brushing

Automatic needle brushing function when start up. By default, the needle is automatically brushed every 8 hours for manual cleaning and maintenance free.

No.2

## Suitable for static removal in a large area

Dual unit independent ion sending port combination.

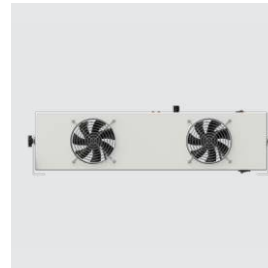

No.3

## Standard tungsten alloy needle

Longer life time compare to titanium and silicon materials.

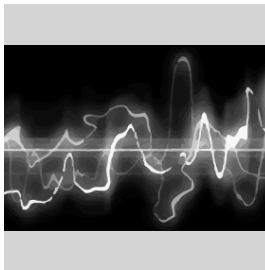
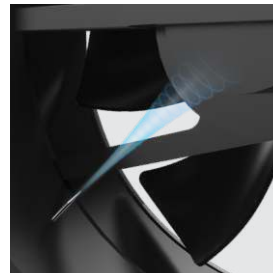

No.4

## CE certification

CE certified which is a high-security and high-reliability static eliminator.

# Product specifications

Product details / Product specifications / Product size

## Product details

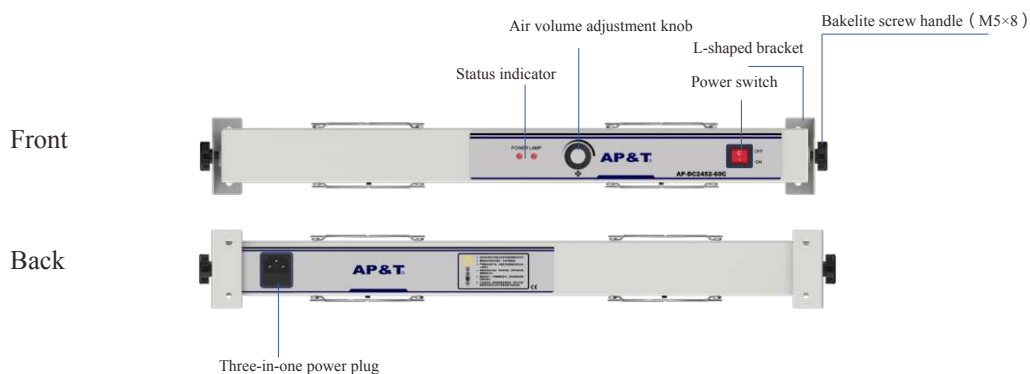

## Product size

Unit: mm

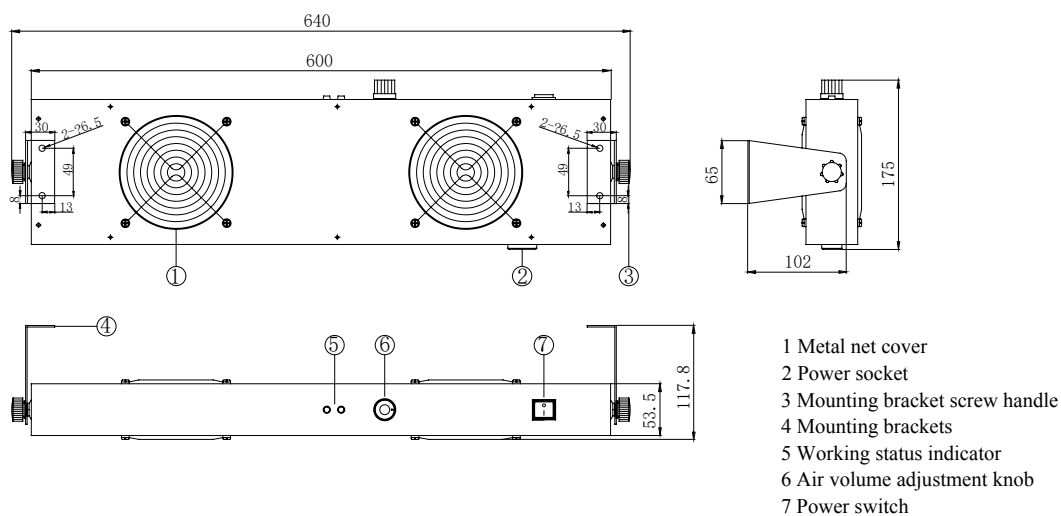

## Product specifications

Model	AP-DC2452-60C
Input voltage	AC220V/50Hz or 110V/60Hz
Power	15W
Working voltage	±DC4000-DC7000V
Ion emission	Steady-state DC
Emitter electrode	Tungsten Alloy
Discharge structure	Uncoupled electrical contact (discharge cylinder)
Discharge range	600*300*750mm ( L*W*H )
Discharge speed	≤ 3s ( 450mm vertical from the center of the air outlet )
Ion balance	≤  ±10V  ( 450mm vertical from the center of the air outlet )
Alarm indicator	The power indicator light on indicates working normally
Air volume	≤ 2*89.1CFM
Noise	≤ 55db ( 150mm away from the air outlet )
Ozone thickness	≤ 0.05ppm ( 150mm away from the air outlet )
Working temperature	0-50℃
Working humidity	30-70%RH
Dimensions	600*175*53.5mm ( L*W*H ) ( Fan body size )
Shell material	Aluminum powder spray
Packaging accessories	1 pair of L-shaped aluminum spray powder mounting bracket, 1 pair of bakelite screw handles ( M6×12 )
Net weight	2450g ( Including power cord, bracket accessories, etc. )
Gross weight	3650g
Warranty	1 Year
Certification	CE



# Products Use

## Step of use/Installation position/Packing accessories

### Step of use

Use screws or bolts to fix on a firm and flat surface (such as a wall or shelf). The angle of ionizing air blower can be adjusted by the knobs on both sides of the bracket to achieve the best static elimination effect.

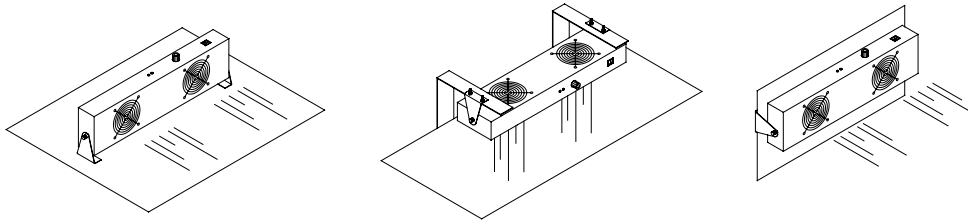

### Installation position

1. Place the ionizing air blower in the working area where static electricity is to be eliminated. And the installation angle should be perpendicular to the surface of the charged body and about 300 to 750 mm away from the static electricity object.

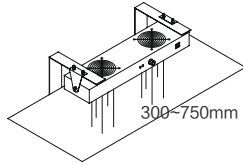

2. Ionizing air blower should be at least 300mm away from the metal conductor and metal grounding body.  
3. More than 200mm away from obstacles such as walls.

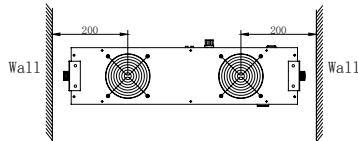

4. The air inlet is at least 150mm away from the wall.

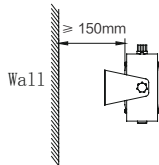

### Packing accessories

Part name	Picture	Part No.	Specification
National standard power cord		8YXG25110	Standard 1.8m, optional 3m/5m



### Safety warning

1. Read the operating instruction carefully before installing and using the device.
2. The whole equipment must be reliably grounded during use.
3. Do not use the device when the humidity is higher than 70%.
4. Do not use the device in inflammable and explosive environment.
5. It is strictly forbidden to disassemble products without authorization. Internal maintenance and repair must be carried out by professional personnel.
6. The product is strictly prohibited to touch liquid during use, otherwise there will be abnormal, resulting in electric shock or fire.
7. Power must be turned off during inspecting or replacing the product, otherwise it may cause electric shock or fire.
8. The product is specially designed for removing static electricity and is strictly prohibited for other purposes. Any abnormal use may cause machine failure, electric shock, fire and other hidden dangers.
9. It is strictly forbidden to touch the electrode needles when power is on, otherwise it is easy to cause fault and electric shock accident.
10. Discharge needle is a sharp metal object, please use it with care.
11. Please check the specifications of the power supply before powering on the product. Any power supply that does not meet the specifications may cause damage or even failure to the product.
12. Check the power cord and communication line regularly. If it is damaged, replace it immediately; otherwise, leakage, poor communication and abnormal operation may occur.

### Trouble shooting

NO	Problems	Reasons	Solutions
1	The indicator on the fan panel is off	Poor contact of the power cable	Check whether the power cable is in good condition and securely connected
		Power supply voltage mismatch	INPUT: 220VAC 50Hz
2	The electrostatic removal performance is obviously reduced	Discharge needle is polluted and damaged	Clean or replace the discharge needle
		Bearing set of ionizing air blower is improper	Confirm the best bearing set
3	The electrostatic removal performance is reduced	There are conductors or other ionizing air blowers around	Remove (moving) conductors or other ionizing air blowers
4	Unable to discharge	High voltage module is damaged	Return to factory for maintenance
		Main-board chip is damaged	Return to factory for maintenance
5	The product is smoky or burnt	The main control board components are burnt out	Return to factory for maintenance

### Maintenance

1. The ionizing air blower should be cleaned and maintained in time according to the use environment and the required electrostatic protection requirements in order to ensure the good performance of the product. That is, gently remove the carbon deposits on the discharge electrode and metal net cover with electrostatic brush, dust-free cloth dipped in anhydrous alcohol. Note:
  - A、 Operation must be done 10 minutes after power cut off.
  - B、 It must be cleaned when dust or white stuff appear on the tip of the needle during use.
  - C、 The ionizing air blower must be powered on after alcohol is completely volatilized after cleaning. No other organic solvent can be used to clean the ionizing air blower.
  - D、 The alloy electrode is a consumable product which is not included in the scope of warranty and will be charged for replacement when repairing.
2. Do not press or rotate the control buttons on the fan panel too hard; otherwise, the device will be permanently damaged.
3. If the working indicator light on the front panel of the fan is off or red, it should be stopped and repaired by professional maintenance personnel. It can be used only after the electrical performance index is normal.

### After-sales service

1. AP- DC2452-60C self-cleaning overhead two fans ionizing air blower has undergone rigorous testing and aging treatment before ex-work. Its performance has completely reached the relevant indicators marked in the usage instruction.
2. AP&T makes a commitment to the customer that any defective parts inspected by AP&T will be repaired or replaced free of charge within one year from the date of purchase. However, this commitment does not apply to: The device is incorrectly used or installed; Damage caused by negligence or accident during use; Modified, disassembled or repaired by other service departments not authorized by Anping Company.
3. AP&T shall not be liable for any incorrect use of the products except for repair or replacement of parts as specified above.