

Type	C7-A1x/ ... V Standard relay 1 change-over contact		
Maximum contact load	16 A/250 V AC-1	0,5 A/110 V DC-1	
	16 A/30 V DC-1	0,2 A/220 V DC-1	
Contacts			
Material	Standard	Code 0	AgNi
Rated current			16 A
Switch-on current max. (20 ms)			40 A
Switching voltage max.			250 V
AC load (Fig 1)			4 kVA
DC load			see Fig. 2
Relay compatible with socket S7-16			

Coil			
Coil resistance			see table; tolerance $\pm 10\%$
Pick-up voltage			$\leq 0,8 \times U_N$
Release voltage			$\geq 0,1 \times U_N$
Nominal power			1,2 VA (AC)/1,3 W (DC)

Coil table						
	VAC	Ω	mA	VDC	Ω	mA
	24	174	50	12	111	108
	48	686	25	24	432	55
	115	4K3	10,4	48	1K7	28
	230	18K6	5,2	110	9K2	12

Insulation	Volt rms, 1 min
Contact open	1000 V
Contact/coil	2,5 kV
Insulation resistance at 500 V	$\geq 1 \text{ G}\Omega$
Insulation, IEC 61810-1	2,5 kV/3

Specifications	
Ambient temperature operation/storage	-40 (no ice)...60 °C / -40 ... 80 °C
Pick-up time/bounce time	16 ms/ ≤ 3 ms
Release time/bounce time	8 ms/ ≤ 1 ms
Mechanical life ops	AC: 10 Mill./DC: 20 Mill.
DC voltage endurance at rated load	≥ 100000 switching cycles
Switching frequency at rated load	≤ 1200 /h
Protection class	IP40
Weight	43 g

Standard types	
VAC 50 Hz/60 Hz: 24, 48, 115 (120), 230 (240) LED	C7-A10/AC ... V C7-A10X/AC ... V
VDC 12, 24, 48, 110 LED	C7-A10/DC ... V C7-A10X/DC ... V
Free wheeling diode	C7-A10DX/DC ... V C7-A10FX/DC ... V
Polarity and free wheeling diode	
AC/DC bridge rectifier 24 V, 48 V, 60 V	C7-A10BX/UC ... V

"..." Enter the voltage for full type designation

Accessories	
Socket:	S7-16



Connection diagram

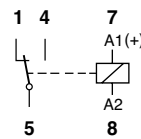

Fig. 1 AC voltage endurance

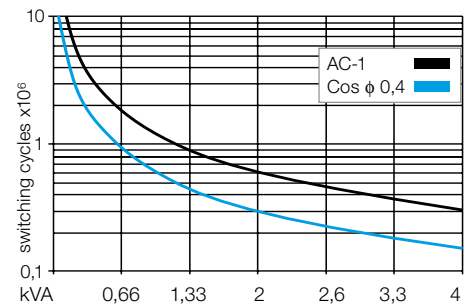
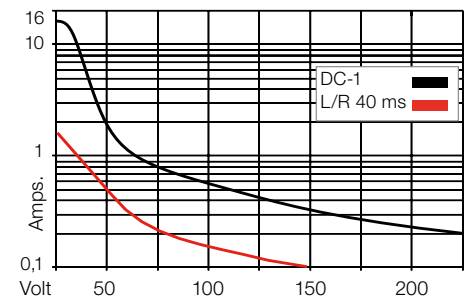
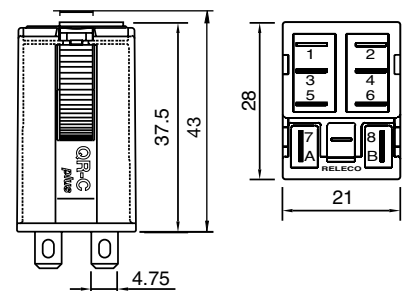

Fig. 2 DC load limit curve



Dimensions [mm]



Technical approvals, conformities



IEC 61810; EN 60947



Type	C7-A2x/ ... V Standard relay 2 change-over contact		
Maximum contact load	10 A/250 V AC-1	0,5 A/110 V DC-1	
	10 A/30 V DC-1	0,2 A/220 V DC-1	
Recommended minimum contact load	10 mA/10 V Code 0, 9		
	5 mA/5 V Code 8		

Contacts			
Material	Standard	Code 0	AgNi
	Optional	Code 8	AgNi + 10 μ Au
	Optional	Code 9	AgNi + 0,2 μ Au
Rated current	10 A		
Switch-on current max. (20 ms)	30 A		
Switching voltage max.	250 V		
AC load (Fig 1)	2,5 kVA		
DC load	see Fig. 2		

Coil			
Coil resistance	see table; tolerance ± 10 %		
Pick-up voltage	≤ 0,8 x U _N		
Release voltage	≥ 0,1 x U _N		
Nominal power	1,2 VA (AC)/1 W (DC)		

Coil table					
VAC	Ω	mA	VDC	Ω	mA
24	174	50	12	148	85
48	686	25	24	594	43
115	4K3	10,4	48	2K3	21
230	18K6	5,2	110	11K4	10

Insulation	Volt rms, 1 min
Contact open	1000 V
Contact/contact	2,5 kV
Contact/coil	2,5 kV
Insulation resistance at 500 V	≥ 1 G.Ω
Insulation, IEC 61810-1	2,5 kV/3

Specifications	
Ambient temperature operation/storage	-40 (no ice)...60 °C /-40 ... 80 °C
Pick-up time/bounce time	16 ms/≤ 3 ms
Release time/bounce time	8 ms/≤ 1 ms
Mechanical life ops	AC: 10 Mill./DC: 20 Mill.
DC voltage endurance at rated load	≥ 100000 switching cycles
Switching frequency at rated load	≤ 1200/h
Protection class	IP40
Weight	43 g

Standard types			
VAC 50 Hz/60 Hz: 24, 48, 115 (120), 230 (240)	C7-A20/AC ... V	C7-A28/AC ... V	C7-A29/AC ... V
LED	C7-A20X/AC ... V	C7-A28X/AC ... V	C7-A29X/AC ... V
VDC 12, 24, 48, 110	C7-A20/DC ... V	C7-A28/DC ... V	C7-A29/DC ... V
LED	C7-A20X/DC ... V	C7-A28X/DC ... V	C7-A29X/DC ... V
Free wheeling diode	C7-A20DX/DC ... V	C7-A28DX/DC ... V	C7-A29DX/DC ... V
Polarity and free wheeling diode	C7-A20FX/DC ... V	C7-A28FX/DC ... V	C7-A29FX/DC ... V
AC/DC bridge rectifier 24 V, 48 V, 60 V	C7-A20BX/UC ... V	C7-A28BX/UC ... V	C7-A29BX/UC ... V

"..." Enter the voltage for full type designation

Accessories	
Socket:	S7-C, S7-I/O, S7-L, S7-P, S7-P0

Connection diagram

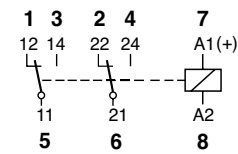

Fig. 1 AC voltage endurance

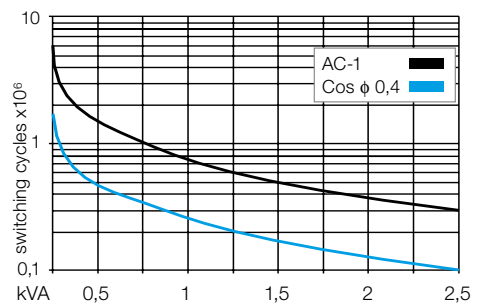
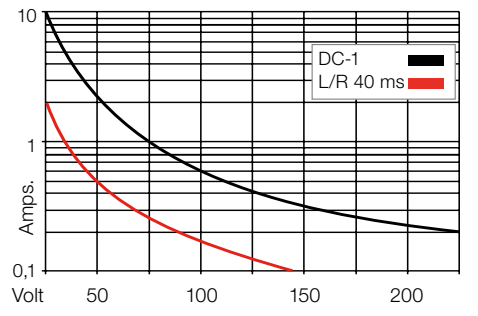
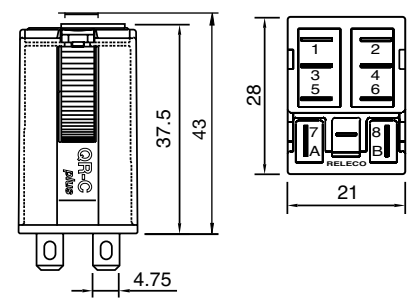

Fig. 2 DC load limit curve



Dimensions [mm]



Technical approvals, conformities

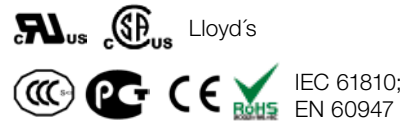

Type	C7-T2x/ ... V Standard relays for low level 2 change-over bifurcated contacts			
Maximum contact load	6 A/250 V	AC-1	6 A/30 V	DC-1
Recommended minimum contact load	5 mA/5 V	Code 1		
	1 mA/5 V	Code 2		

Contacts			
Material	Standard	Code 1	AgNi + 0,2 μ Au
	Optional	Code 2	AgNi + 10 μ Au
Rated current	6 A		
Switch-on current max. (20 ms)	15 A		
Switching voltage max.	250 V		
AC load (Fig 1)	1,2 kVA		
DC load	see fig. 2		

Coil			
Coil resistance	see table; tolerance ± 10 %		
Pick-up voltage	≤ 0,8 × U _N		
Release voltage	≥ 0,1 × U _N		
Nominal power	1,2 VA (AC)/1 W (DC)		

Coil table						
	VAC	Ω	mA	VDC	Ω	mA
	24	174	50	12	148	85
	48	686	25	24	594	43
	115	4K3	10,4	48	2K3	21
	230	18K6	5,2	110	11K4	10

Insulation	Volt rms, 1 min
Contact open	1000 V
Contact/contact	2,5 kV
Contact/coil	2,5 kV
Insulation resistance at 500 V	≥ 1 GΩ
Insulation, IEC 61810-1	2,5 kV/3

Specifications	
Ambient temperature operation/storage	-40 (no ice)...60 °C / -40 ... 80 °C
Pick-up time/bounce time	16 ms/≤ 3 ms
Release time/bounce time	8 ms/≤ 1 ms
Mechanical life ops	AC: 10 Mill./DC: 20 Mill.
DC voltage endurance at rated load	≥ 100000 switching cycles
Switching frequency at rated load	≤ 1200/h
Protection class	IP40
Weight	43 g

Standard types		
VAC 50 Hz/60 Hz: 24, 48, 115 (120), 230 (240) LED	C7-T21/AC ... V C7-T21X/AC ... V	C7-T22/AC ... V C7-T22X/AC ... V
VDC 12, 24, 48, 110 LED	C7-T21/DC ... V C7-T21X/DC ... V	C7-T22/DC ... V C7-T22X/DC ... V
Free wheeling diode	C7-T21DX/DC ... V	C7-T22DX/DC ... V
Polarity and free wheeling diode	C7-T21FX/DC ... V	C7-T22FX/DC ... V
AC/DC bridge rectifier 24 V, 48 V, 60 V	C7-T21BX/UC ... V	C7-T22BX/UC ... V

"..." Enter the voltage for full type designation

Accessories	
Socket:	S7-C, S7-I/O, S7-L, S7-P, S7-P0



Connection diagram

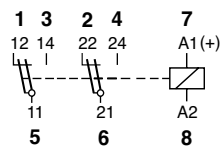

Fig. 1 AC voltage endurance

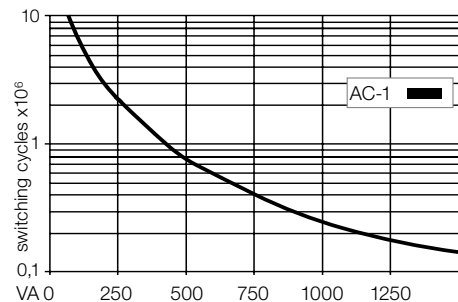
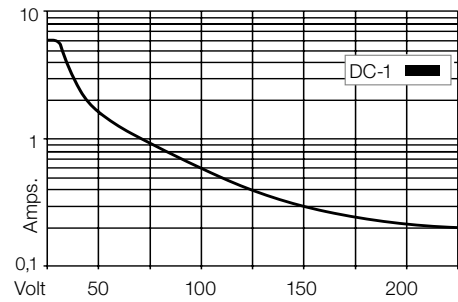
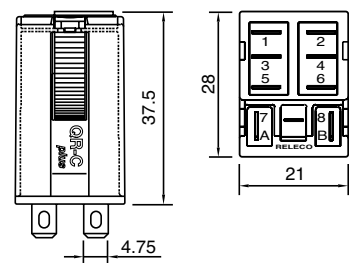

Fig. 2 DC load limit curve



Dimensions [mm]



Technical approvals, conformities



IEC 61810; EN 60947



Type	C7-G2x/ ... V Power relay, DC application 2 open contacts, gap 1,5mm		
-------------	---	--	--

Maximum contact load	10 A/250 V AC-1	0,8 A/110 V DC-1
	10 A/30 V DC-1	0,4 A/220 V DC-1

Contacts			
Material	Standard	Code 0	AgNi
Rated current			10 A
Switch-on current max. (20 ms)			30 A
Switching voltage max			250 V
AC load (Fig 1)			2,5 kVA
DC load			see fig. 2

Coil	
Coil resistance	see table; tolerance $\pm 10\%$
Pick-up voltage	$\leq 0,8 \times U_N$
Release voltage	$\geq 0,1 \times U_N$
Nominal power	1,5 VA (AC)/1,5 W (DC)

Coil table					
VAC	Ω	mA	VDC	Ω	mA
24	153	62	12	99	121
48	611	31	24	388	61
115	3K6	13	48	1K5	32
230	14K6	6,5	110	8K	14

Insulation	
	Volt rms, 1 min
Contact open	2000 V
Contact/contact	2,5 kV
Contact/coil	2,5 kV
Insulation resistance at 500 V	$\geq 1 \text{ G}\Omega$
Insulation, IEC 61810-1	2,5 kV/3

Specifications	
Ambient temperature operation/storage	-40 (no ice)...60 °C / -40 ... 80 °C
Pick-up time/bounce time	20 ms/ ≤ 3 ms
Release time/bounce time	10 ms/ ≤ 1 ms
Mechanical life ops	AC: 10 Mill./DC: 20 Mill.
DC voltage endurance at rated load	≥ 100000 switching cycles
Switching frequency at rated load	≤ 1200 /h
Protection class	IP40
Weight	43 g

Standard types	C7-G20/AC ... V
VAC 50 Hz/60 Hz: 24, 48, 115 (120), 230 (240) LED	C7-G20X/AC ... V

VDC 12, 24, 48, 110 LED	C7-G20/DC ... V
Free wheeling diode	C7-G20X/DC ... V
Polarity and free wheeling diode	C7-G20DX/DC ... V
	C7-G20FX/DC ... V

AC/DC bridge rectifier 24 V, 48 V, 60 V	C7-G20BX/UC ... V
--	--------------------------

"..." Enter the voltage for full type designation

Accessories	
Socket:	S7-C, S7-I/O, S7-L, S7-P, S7-P0

Connection diagram

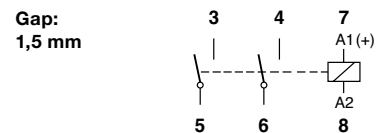

Fig. 1 AC voltage endurance

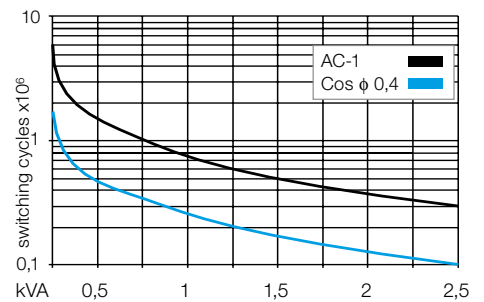
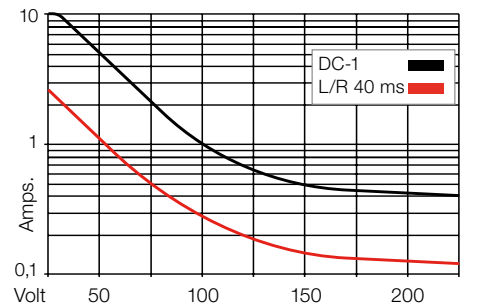
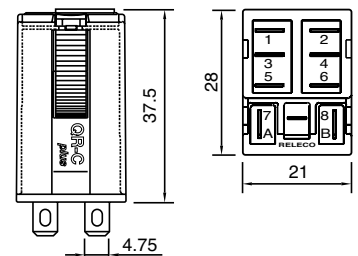

Fig. 2 DC load limit curve



Dimensions [mm]



Technical approvals, conformities



IEC 61810; EN 60947

C7-X1x

4-pin, miniature power relay, 1-pole, double make contact, faston

Type	C7-X1x/ ... V Power relay, DC application 1 pole, NO, double make		
-------------	--	--	--

Maximum contact load	10 A/250 V AC-1	6 A/110 V DC-1
	10 A/30 V DC-1	1 A/220 V DC-1

Contacts			
Material	Standard	Code 0	AgNi
Rated current			10 A
Switch-on current max. (20 ms)			30 A
Switching voltage max.			250 V
AC load			2,5 kVA
DC load			see Fig. 2

Coil	
Coil resistance	see table; tolerance ± 10 %
Pick-up voltage	≤ 0,8 x U _N
Release voltage	≥ 0,1 x U _N
Nominal power	1,5 VA (AC)/1,3 W (DC)

Coil table					
VAC	Ω	mA	VDC	Ω	mA
24	153	62	12	111	108
48	611	31	24	432	55
115	3K6	13	48	1K7	27
230	14K6	6,5	110	9K2	12

Insulation		Volt rms, 1 min
Contact open		2,5 kV
Contact/coil		2,5 kV
Insulation resistance at 500 V		≥ 1 GΩ
Insulation, IEC 61810-1		2,5 kV/3

Specifications	
Ambient temperature operation/storage	-40 (no ice)...60 °C / -40 ... 80 °C
Pick-up time/bounce time	20 ms/≤ 3 ms
Release time/bounce time	10 ms/≤ 1 ms
Mechanical life ops	AC: 10 Mill./DC: 20 Mill.
DC voltage endurance at rated load	≥ 100000 switching cycles
Switching frequency at rated load	≤ 1200/h
Protection class	IP40
Weight	43 g

Standard types	
VAC 50 Hz/60 Hz: 24, 48, 115 (120), 230 (240) LED	C7-X10/AC ... V C7-X10X/AC ... V
VDC 12, 24, 48, 110 LED	C7-X10/DC ... V C7-X10X/DC ... V
Free wheeling diode	C7-X10DX/DC ... V C7-X10FX/DC ... V
Polarity and free wheeling diode	
AC/DC bridge rectifier 24 V, 48 V, 60 V	C7-X10BX/UC ... V

"..." Enter the voltage for full type designation

Accessories	
Socket:	S7-C, S7-I/O, S7-L, S7-P, S7-P0



Connection diagram

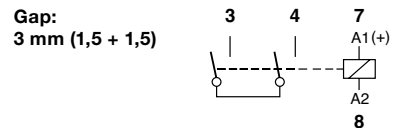

Fig. 1 AC voltage endurance

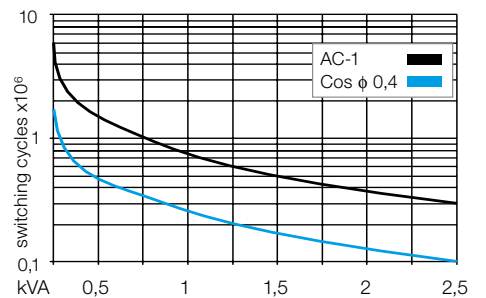
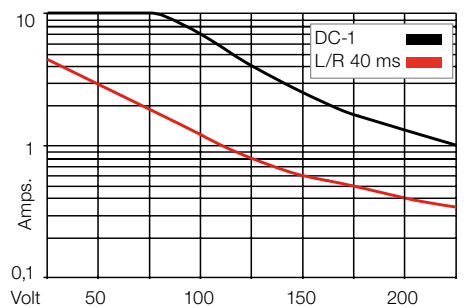
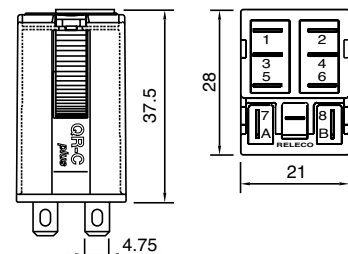

Fig. 2 DC load limit curve



Dimensions [mm]



Technical approvals, conformities



IEC 61810; EN 60947



Type	C7-H23/ ... V Special relays 1 x CO power contact 1 x CO twin contact		
Maximum contact load	10 A / 250 V AC-1	6 A / 250 V AC-1	6 A / 30 V DC-1
Recommended minimum contact load	10 mA/10 V (Power contacts) 5 mA/5V (twin contacts)		

Contacts	
Power contact	
Standard material	AgNi
Rated current	10 A
Switch-on current max. (20 ms)	30 A
Switching voltage max.	2,5 kV
AC load (Fig 1)	2,5 VA
DC load	see fig. 2
*Power contact only	

Twin contact	
Standard material	AgNi + 0,2 μ Au
Rated current	6 A
Switch-on current max. (20 ms)	15 A
Switching voltage max.	250 V

Coil	
Coil resistance	see table; tolerance ± 10 %
Pick-up voltage	≤ 0,8 x U _N
Release voltage	≥ 0,1 x U _N
Nominal power	1,2 VA (AC) / 1 W (DC)

Coil table	VAC Ω ± 10% mA	VDC Ω ± 10% mA
	24 174 50	12 148 81
	48 686 25	24 594 40
	115 4K3 10.4	48 2K3 21
	230 18K6 5.2	110 11K4 10

Insulation	
Coil resistance	Volt rms, 1 min
Contact open	1000 V
Contact/contact	2,5 kV
Contact/coil	2,5 kV
Insulation, IEC 61810-1:	2,5 kV/3

Specifications	
Ambient temperature operation/storage	40 (no ice)...60 °C / -40 ... 80 °C
Mechanical life ops	AC: 10 Mill./DC: 20 Mill.
Protection class	IP40
Weight	43 g

Standard types	C7-H23/AC ... V C7-H23X/AC ... V
VAC 50 Hz/60 Hz: 24, 48, 115 (120), 230 (240) LED	C7-H23/DC ... V C7-H23X/DC ... V C7-H23DX/DC ... V C7-H23FX/DC ... V
VDC 12,24, 48, 110 LED	C7-H23BX/UC ... V
Free wheeling diode	
Polarity and free wheeling diode	
UC 24 V, 48 V, 60 V	

"..." Enter the voltage for full type designation

Accessories	S7-C, S7-I/O, S7-L, S7-P, S7-PO
Socket:	

Connection diagram

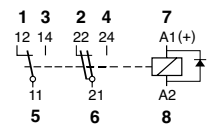

***Fig. 1 AC voltage endurance**

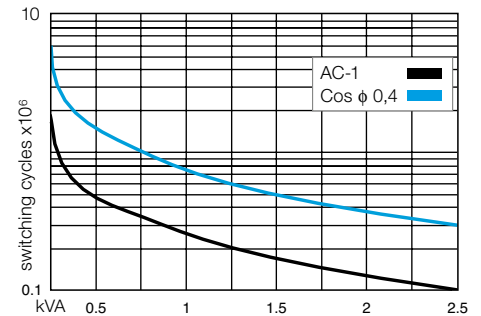

***Fig. 2 DC load limit curve**

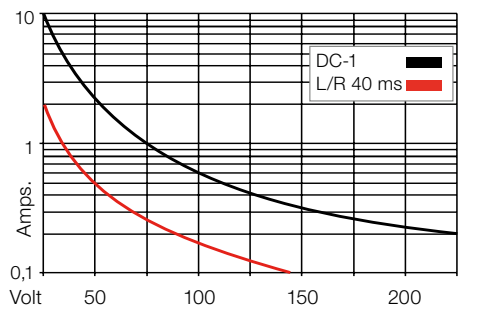

Dimensions [mm]

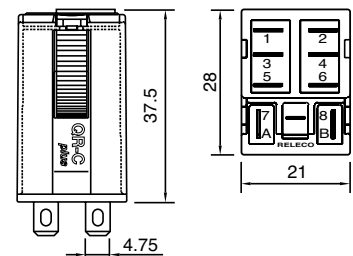

Technical approvals, conformities



IEC 61810; EN 60947

C7-W1x

4-pin, miniature relay, 1-pole, tungsten contact, faston

Type: **C7-W1x/ ... V**
 Power relay for high inrush current
 1 pole normally open

Maximum contact load: **10 A/250 V AC-1** **6 A/250 V AC-5a/b**
Recommended minimum contact load: **10 mA/10 V**

Contacts

Material	Standard	Code 0	AgNi/W
Rated current			10 A
Switch-on current max. (2,5 ms)			500 A
Switching voltage max.			250 V
AC load (Fig 1)			2,5 kVA
DC load			see fig. 2

Coil

Coil resistance	see table; tolerance ± 10 %
Pick-up voltage	≤ 0,8 × U _N
Release voltage	≥ 0,1 × U _N
Nominal power	1,5 VA (AC)/1,5 W (DC)

Coil table

VAC	Ω	mA	VDC	Ω	mA
24	153	62	12	99	121
48	611	31	24	388	61
115	3K6	13	48	1K5	32
230	14K5	6,5	110	8K	14

Insulation

	Volt rms, 1 min
Contact open	1000 V
Contact/coil	2,5 kV
Insulation resistance at 500 V	≥ 1 GΩ
Insulation, IEC 61810-1	2,5 kV

Specifications

Ambient temperature operation/storage	-40 (no ice)...60 °C / -40 ... 80 °C
Pick-up time/bounce time	20 ms/≤ 3 ms
Release time/bounce time	10 ms/≤ 1 ms
Mechanical life ops	AC: 10 Mill./DC: 20 Mill.
DC voltage endurance at rated load	≥ 100000 switching cycles
Switching frequency at rated load	≤ 1200/h
Protection class	IP40
Weight	43 g

Standard types

VAC 50 Hz/60 Hz: 24, 48, 115 (120), 230 (240) LED

VDC 12, 24, 48, 110 LED

Free wheeling diode

Polarity and free wheeling diode

AC/DC bridge rectifier 24 V, 48 V, 60 V

C7-W10/AC ... V
C7-W10X/AC ... V

C7-W10/DC ... V
C7-W10X/DC ... V
C7-W10DX/DC ... V
C7-W10FX/DC ... V

C7-W10BX/UC ... V

"..." Enter the voltage for full type designation

Accessories

Socket: **S7-C, S7-I/O, S7-L, S7-P, S7-P0**
 Optional accessories (blanking plug): **S9-NP, S9-OP**



Connection diagram

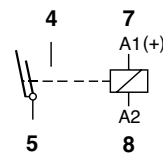

Fig. 1 AC voltage endurance

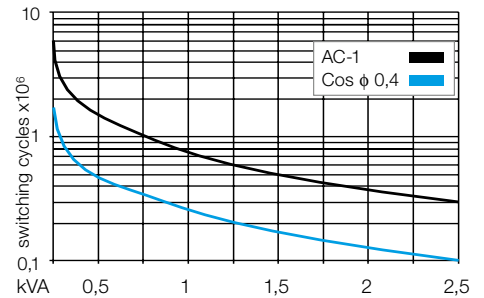
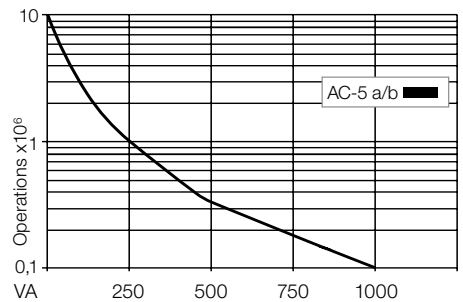
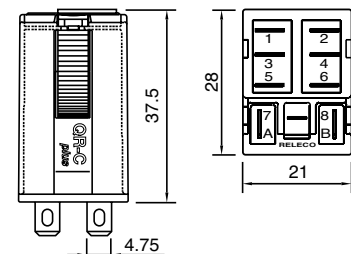

Fig. 2 AC voltage endurance



Dimensions [mm]



Technical approvals, conformities



IEC 61810; EN 60947

R7-A2x

8-pin, miniature standard relay, 2-pole, plug-in

Relay approval: EN 60077-1-2/99 - EN 61373/99 for Railway application

Type	R7-A2x/DC ... V Railway application Sensitive, 2 change-over contacts
-------------	--

Maximum contact load:	10 A/250 V AC-1 10A/30V DC-1
Recommended minimum contact load	10 mA/10 V Code 0, 4 5 mA/5 V Code 8

Contacts

Material	Standard	Code 0	AgNi
	Optional	Code 4	AgNi + 0,2µ Au
	Optional	Code 8	AgNi + 10µ Au
Rated current	10 A		
Switch-on current max. (20 ms)	30 A		
Switching voltage max.	250 V		
AC load	see fig. 1		
DC load	see fig. 2		

Coil

Coil resistance	see table; tolerance ± 10 %
Release voltage	0,7 U _N ... 1,25 U _N
Pick-up voltage	≥ 0,1 x U _N
Nominal power	1,07 W

Coil table

Voltage	Ω ± 10%	mA
24	535	45
48	2004	24
72	4750	15
110	11337	10

Insulation

	Volt rms, 1 min
Pollution grade	PD3
Pulse (1,2 /50µs) Dielectric strenght (1Minute/V rms)	
Contact/coil	4KV / 2200V
Between different poles	4KV / 2200V
Between contact and the same pole	1550 / 850V

Specifications

Ambient temperature operation/storage	-25 (no ice)...70 °C / -40 ... 80 °C
Number of mechanical operations	>20millions
Thermic class	B (130° C)
Vibration : category / class	1 / B Body mounted
Vibration	5-150Hz (3 axes)
Shock	5g (3 axes)
Operation (UN) / release time	10 ms/ 15 ms
Weight	35 g
Weight avg. Relay + Socket (S7-M)	75g
Protection class	IP40

Standard types

VDC 24, 48, 72, 110	R7-A20/DC ... V	R7-A24/DC ... V	R7-A28/DC ... V
LED	R7-A20X/DC ... V	R7-A24X/DC ... V	R7-A28X/DC ... V
Free wheeling diode	R7-A20D/DC ... V	R7-A24D/DC ... V	R7-A28D/DC ... V
LED + free wheeling diode	R7-A20DX/DC ... V	R7-A24DX/DC ... V	R7-A28DX/DC ... V

"..." Enter the voltage for full type designation

Accessories

Socket:	S7-C, S7-I/O, S7-L, S7-P, S7-P0
---------	--



Connection diagram

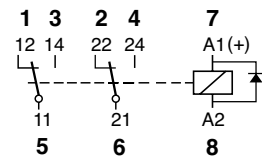

Fig. 1 AC voltage endurance

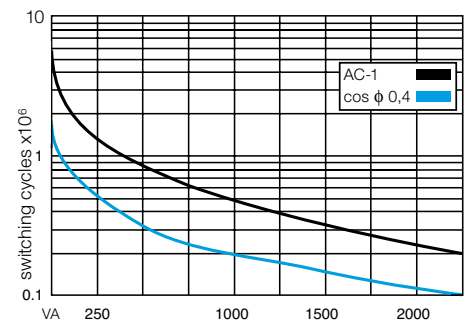
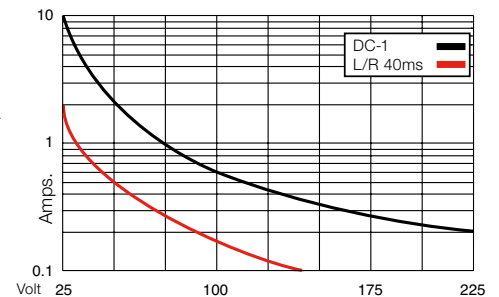
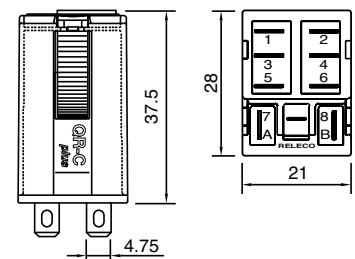

Fig. 2 DC load limit curve



Dimensions [mm]



Technical approvals, conformities



EN 60077-1-2/99; EN 61373/99

R7-T2x

8-pin, miniature industrial relay, 2-pole, change-over contact, faston
Relay approval: EN 60077-1-2/99 - EN 61373/99 for Railway application

Type	R7-T2x/DC ... V Railway application Sensitive, 2 change-over contact		
Maximum contact load	6 A/250 V AC-1		6 A/30 V DC-1
Recommended minimum contact load	5 mA/5 V Code 1		1 mA/5 V Code 2

Contacts			
Material	Standard	Code 1	AgNi + 0,2µ Au
	Optional	Code 2	AgNi + 10µ Au
Rated current	6 A		
Switch-on current max. (20 ms)	15 A		
Switching voltage max.	250 V		
AC load	see fig. 1		
DC load	see fig. 2		

Coil	
Coil resistance	see table; tolerance ± 10 %
Operation range	0,7 U _N ... 1,25 U _N
Contact open	≥ 0,1 x U _N
Nominal power	1,07 W

Coil table	Voltage	Ω ± 10%	mA
	24	535	45
	48	2004	24
	72	4750	15
	110	11337	10

Insulation	Volt rms, 1 min
Pollution grade	PD3
Pulse (1,2 / 50µs) Dielectric strenght (1Minute/V rms)	
Contact/coil	4KV / 2200V
Between different poles	4KV / 2200V
Between contact and the same pole	1550 / 850V

Specifications	
Ambient temperature operation/storage	-25 (no ice)...70 °C / -40 ... 80 °C
Number of mechanical operations	≥ 20 millions
Thermic class	B (130° C)
Vibration : category / class	1 / B Body mounted
Vibration	5-150Hz (3 axes)
Shock	5g (3 axes)
Operation (UN) / release time	10 ms/ 15 ms
Weight	35 g
Weight avg. Relay + Socket (S7-M)	75g
Protection class	IP40

Standard types		
VDC 24, 48, 72, 110	R7-T21/DC ... V	R7-T22/DC ... V
LED	R7-T21X/DC ... V	R7-T22X/DC ... V
Free wheeling diode	R7-T21D/DC ... V	R7-T22D/DC ... V
LED + free wheeling diode	R7-T21DX/DC ... V	R7-T22DX/DC ... V

"..." Enter the voltage for full type designation

Accessories	
Socket:	S7-C, S7-I/O, S7-L, S7-P, S7-P0



Connection diagram

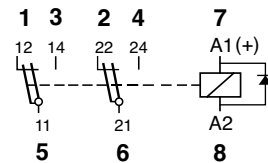

Fig. 1 AC voltage endurance

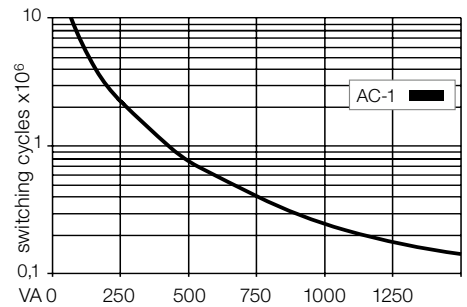
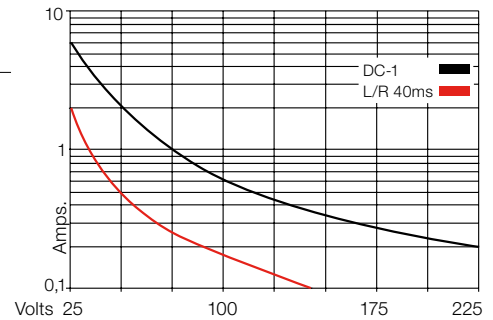
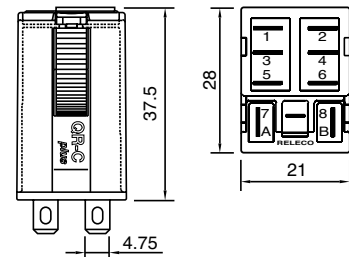

Fig. 2 DC load limit curve



Dimensions [mm]



Technical approvals, conformities



IEC 60077; EN 60077-1-2/99; EN 61373/99