



SEW
EURODRIVE



MOVIDRIVE[®] MDX60B / 61B **(DR and CMP Motor Assignment)**

Edition 09/2008

16658817 / EN

Catalog

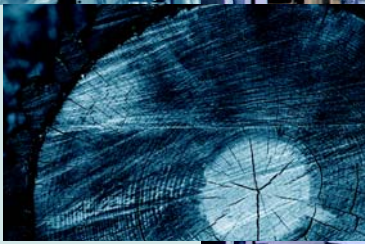
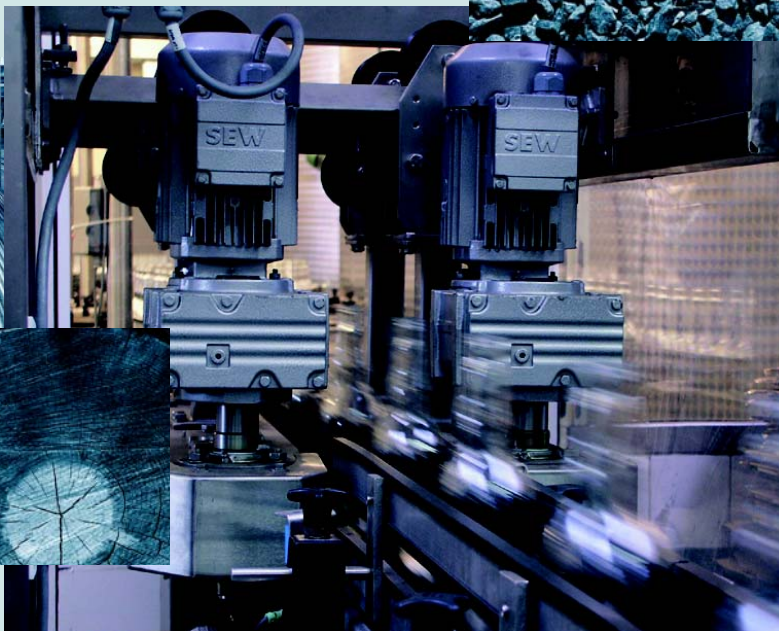



1	Important Notes	4
2	Technical Data	5
2.1	Prefabricated cables	5
3	Motor Selection	15
3.1	Basic recommendations for motor selection	15
3.2	Motor selection for asynchronous AC motors (VFC).....	15
3.3	Motor selection for asynchronous servomotors (CFC).....	29
3.4	Motor selection for synchronous servomotors (SERVO)	75
4	Index	81



1 Important Notes

	NOTES
	<ul style="list-style-type: none"> • This additional catalog supplements the MOVIDRIVE® MDX60B/61B catalog, publication number 11697016 (EN), edition 04/2008 by the following contents: <ul style="list-style-type: none"> – Additional prefabricated cables and extension cables for connecting the new motor sizes CMP71 - 100 (see section "Technical Data"). – Assignment of prefabricated cables offered by SEW-EURODRIVE for connecting various system components to the new DR motor series (see chapter "Technical Data"). – Assignment of the new DR motors to the MOVIDRIVE® B inverter (see chapter "Motor Selection"). – Supplemented CMP motor table and motor/inverter assignment with the new motor sizes CMP71 - 100 (see chapter "Motor Selection"). The new motor sizes CMP71 - 100 are available from the 1st quarter of 2009. • Only electrical specialists are allowed to perform installation and startup observing relevant accident prevention regulations and the MOVIDRIVE® MDX60B/61B operating instructions.

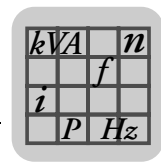

2 Technical Data

2.1 Prefabricated cables

Overview

SEW offers cable sets and prefabricated cables for straightforward and error-free connection of various system components to MOVIDRIVE®. The cables are prefabricated in 1 m steps to the required length. It is necessary to differentiate between whether the cables are intended for fixed routing or for cable carrier applications.

1. Motor cables and extension cables for connecting CMP80 - 100 motors
2. Connection to DEH11B/DEH21B: Different types of encoder and extension cables for DR motors

1. Prefabricated cables and extension cables for connecting CMP80 - 100 motors

Motor cables

The cables are equipped with a connector for motor connection and conductor end sleeves for inverter connection.

Number of cores and line cross section	Part number	Installation type	for motor
4×6 mm ²	1335 026 9	Fixed installation	CMP...SMB
4×6 mm ² + 2×1.5 mm ²	1335 019 6		CMP...SBB
4×10 mm ²	1335 027 7		CMP...SMB
4×10 mm ² + 2×1.5 mm ²	1335 021 8		CMP...SBB
4×16mm ²	1335 028 5		CMP...SMB
4×16mm ² + 2×1.5 mm ²	1335 022 6		CMP...SBB

Number of cores and line cross section	Part number	Installation type	for motor
4×6 mm ²	1335 029 3	Cable carrier installation	CMP...SMB
4×6 mm ² + 2×1.5 mm ²	1335 023 4		CMP...SBB
4×10 mm ²	1335030 7		CMP...SMB
4×10 mm ² + 2×1.5 mm ²	1335 024 2		CMP...SBB
4×16mm ²	1335 031 5		CMP...SMB
4×16mm ² + 2×1.5 mm ²	1335 025 0		CMP...SBB

Extension cables

The cables are equipped with a connector and adapter for extending the motor cable.

Number of cores and line cross section	Part number	Installation type	for motor
4×6 mm ²	1334 999 6	Fixed installation	CMP...SMB
4×6 mm ² + 3×1.5 mm ²	1335 006 4		CMP...SBB
4×10 mm ²	1335 000 5		CMP...SMB
4×10 mm ² + 3×1.5 mm ²	1335 007 2		CMP...SBB
4×16mm ²	1335 001 3		CMP...SMB
4×16mm ² + 3×1.5 mm ²	1335 008 0		CMP...SBB

Number of cores and line cross section	Part number	Installation type	for motor
4×6 mm ²	1335 002 1	Cable carrier installation	CMP...SMB
4×6 mm ² + 3×1.5 mm ²	1335 009 9		CMP...SBB
4×10 mm ²	1335 004 8		CMP...SMB
4×10 mm ² + 3×1.5 mm ²	1335 010 2		CMP...SBB
4×16mm ²	1335 005 6		CMP...SMB
4×16mm ² + 3×1.5 mm ²	1333 011 0		CMP...SBB

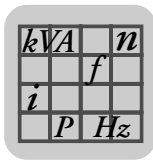



2. Prefabricated cables for connection at X15 of the DEH11B / DEH21B option

The following overview shows the possible connections at X15 of the DEH11B/DEH21B options.

Meaning of the symbols

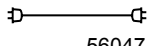
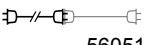
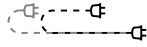
The connection cables are assigned a part number and a symbol. The symbols have the following meaning:

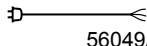
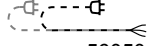
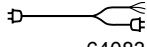
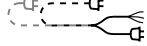
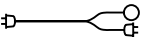
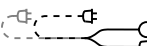
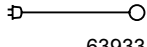
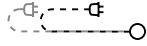
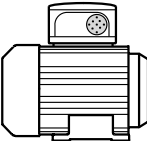
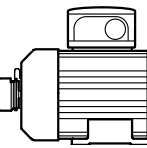
Symbol	Meaning
 56047AXX	Connection cable connector → connector for fixed installation
 56051AXX	Extension connection cable connector → connector for fixed installation
 56048AXX	Connection cable connector → connector for cable carrier installation
 56052AXX	Extension connection cable connector → connector for cable carrier installation
 56049AXX	Connection cable connector → conductor end sleeves for fixed installation
 56050AXX	Connection cable connector → conductor end sleeves for cable carrier installation
 64083AXX	Connection cable connector → Y-cable with connector and conductor end sleeves for fixed installation
 64082AXX	Connection cable connector → Y-cable with connector and conductor end sleeves for cable carrier installation
 64134AXX	Connection cable connector → Y-cable with connector and encoder connection cover for fixed installation
 64151AXX	Connection cable connector → Y-cable with connector and encoder connection cover for cable carrier installation
 63933AXX	Connection cable connector → encoder connection cover for fixed installation
 63932AXX	Connection cable connector → encoder connection cover for cable carrier installation
 64140AXX	Connection via plug connector on the motor side
 64139AXX	Connection via encoder connection cover on the motor side

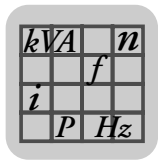

Connection options for encoders at X15 DEH11B/DEH21B

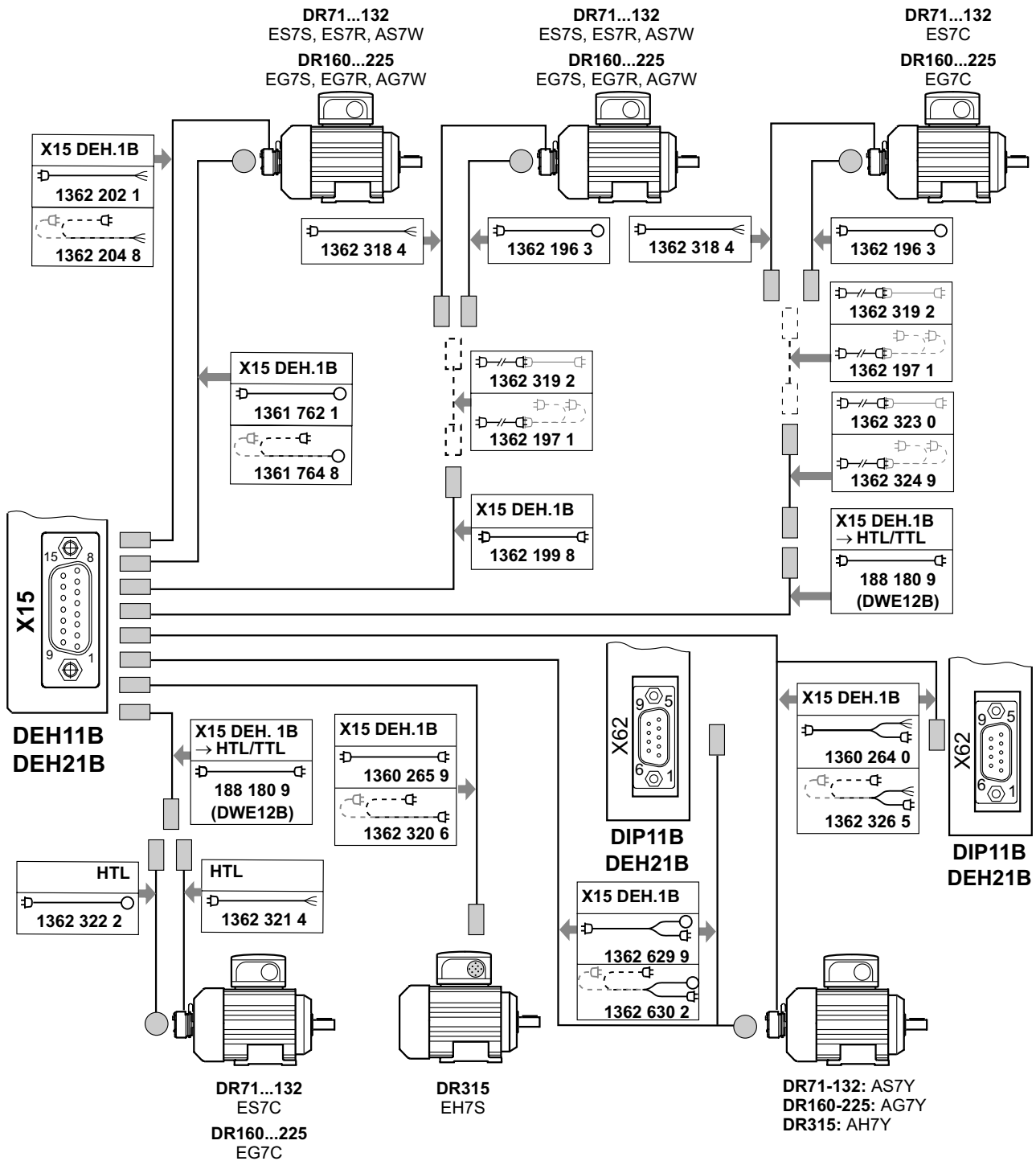

64070AXX

Dashed line: Shows extension cables that can be used as option.

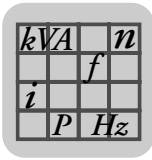

Technical Data
Prefabricated cables

- Encoder connection:
 - ES7S, ES7R, AS7W to motors DR71 ... 132
 - EG7S, EG7R, AG7W to motors DR160 ... 225

Required prefabricated cables:

- Possibility 1: Cable with D-sub 15 plug connector and encoder connection cover:

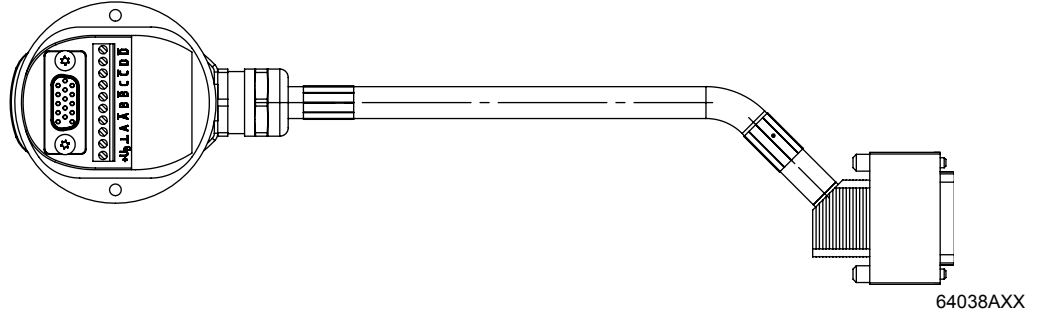

- Possibility 2: Cable with D-sub 15 plug connector and conductor end sleeves:

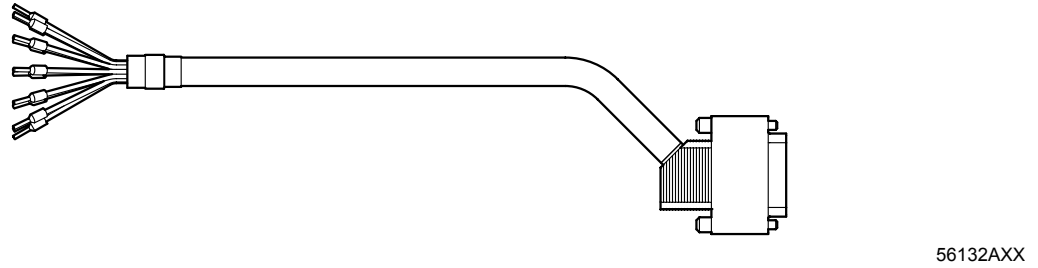

Motor size	Encoder type	Encoder cable	
		Installation	Part number
DR71 ... 132 DR160 ... 225	ES7S, ES7R, AS7W EG7S, EG7R, AG7W	 63933AXX	1361 762 1
		 63932AXX	1361 764 8
		 56049AXX	1362 202 1
		 56050AXX	1362 204 8

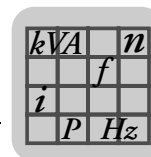

- Encoder connection:
 - ES7S, ES7R, AS7W to motors DR71 ... 132
 - EG7S, EG7R, AG7W to motors DR160 ... 225

Required prefabricated cables:

- Possibility 1: Cable with encoder connection cover and M23 plug connector:

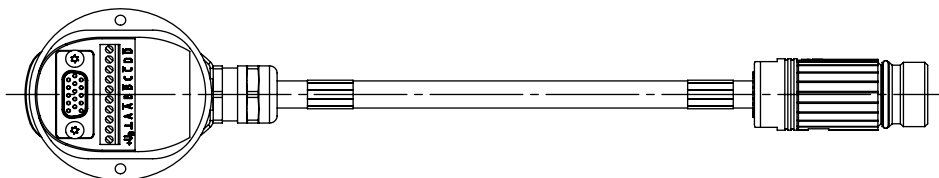

64044AXX

- Possibility 2: Cable with M23 plug connector and conductor end sleeves:

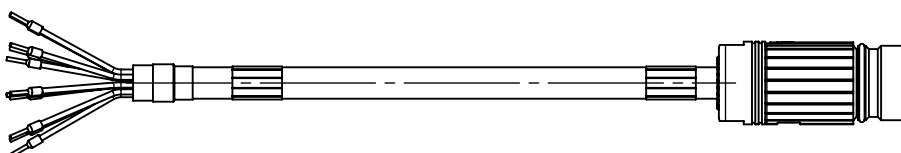

64043AXX

- Optional: Extension cable with M23 plug connector on both sides:

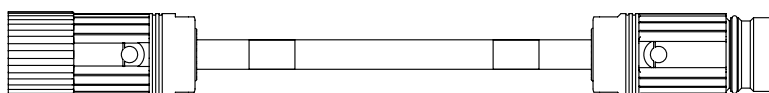

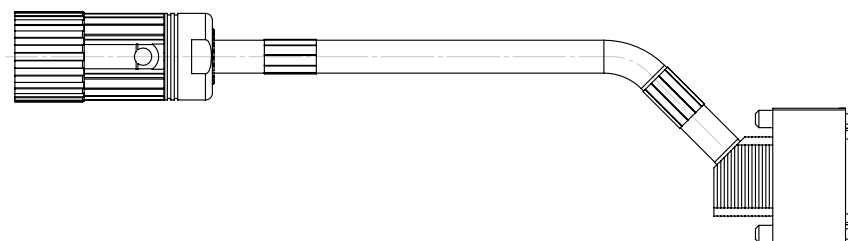

56136AXX

- Cable with M23 plug connector and D-sub 15 plug connector:

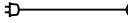
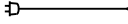
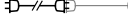
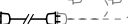

64042AXX

Motor size	Encoder type	Encoder cable	
		Installation	Part number
DR71 ... 132 DR160 ... 225	ES7S, ES7R, AS7W EG7S, EG7R, AG7W	 63933AXX	1362 196 3
		 56049AXX	1362 318 4
		 56051AXX	1362 319 2
		 56052AXX	1362 197 1
		 56047AXX	1362 199 8

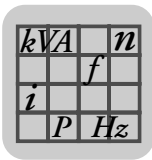

Technical Data
Prefabricated cables

- Encoder connection:
 - ES7C to motors DR71 ... 132
 - EG7C to motors DR160 ... 225

Required prefabricated cables:

- Possibility 1: Cable with D-sub 9 plug connector and encoder connection cover:

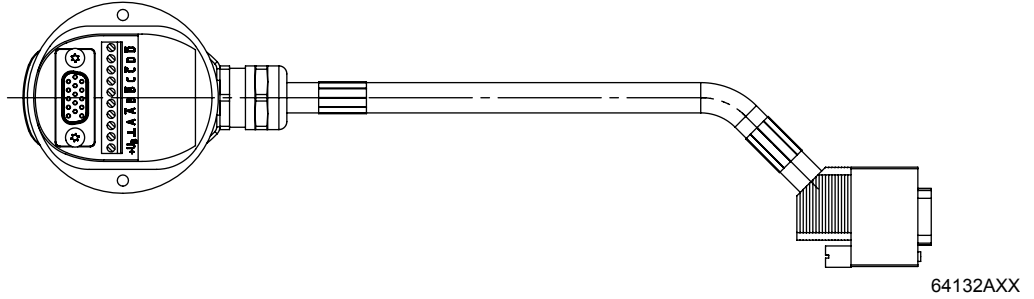

- Possibility 2: Cable with D-sub 9 plug connector and conductor end sleeves:

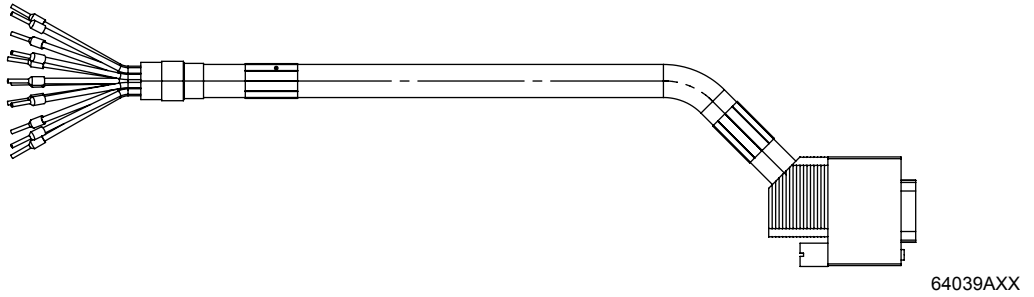

- DWE12B option, interface adapter HTL → TTL (length: 1 m):

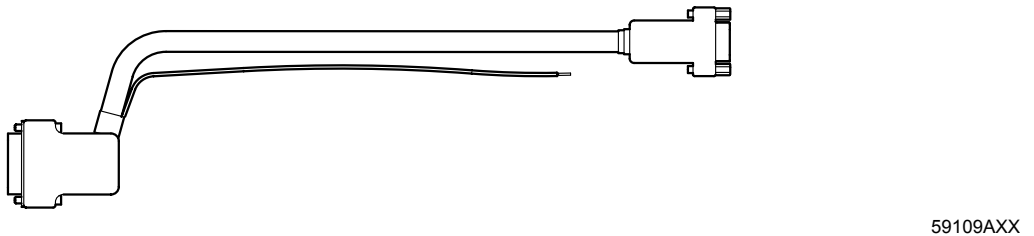

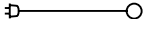
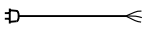
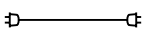
Motor size	Encoder type	Encoder cable	
		Installation	Part number
DR71 ... 132 DR160 ... 225	ES7C EG7C	 63933AXX	1362 322 2
		 56049AXX	1362 321 4
		 56047AXX	188 180 9

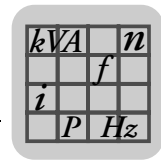

- Encoder connection:
 - ES7C to motors DR71 ... 132
 - EG7C to motors DR160 ... 225

Required prefabricated cables:

- Possibility 1: Cable with encoder connection cover and M23 plug connector:

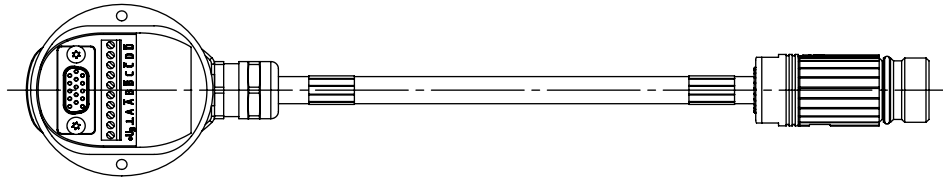

64044AXX

- Possibility 2: Cable with M23 plug connector and conductor end sleeves:

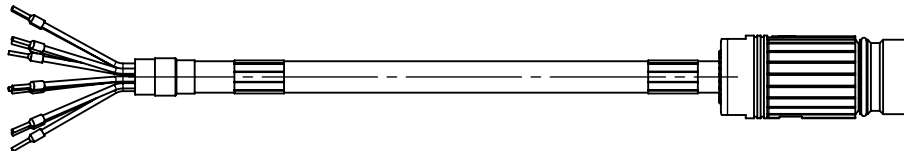

64043AXX

- Optional: Extension cable with M23 plug connector on both sides:

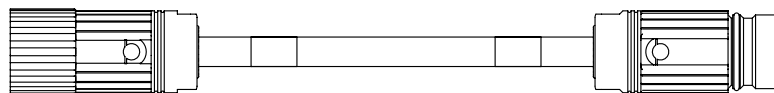

56136AXX

- Extension cable with M23 plug connector and D-sub 9 plug connector:

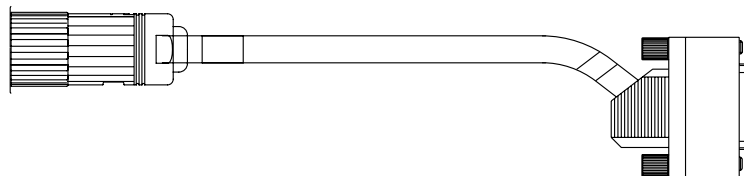

56135AXX

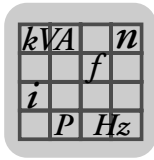

– DWE12B option, interface adapter HTL→ TTL (length: 1 m):

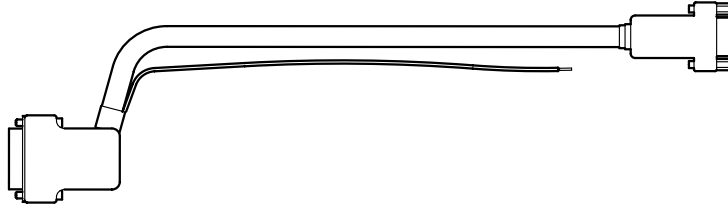

59109AXX

Motor size	Encoder type	Encoder cable	
		Installation	Part number
DR71 ... 132 DR160 ... 225	ES7C EG7C	 63933AXX	1362 196 3
		 56049AXX	1362 318 4
		 56047AXX	1362 319 2
		 56048AXX	1362 197 1
		 56047AXX	1362 323 0
		 56048AXX	1362 324 9
		 56047AXX	188 180 9

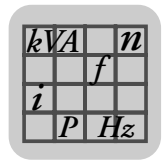

- Connecting EH7S encoder to DR315 motors

Required prefabricated cables:

- Cable with M23 plug connector and D-sub 15 plug connector:

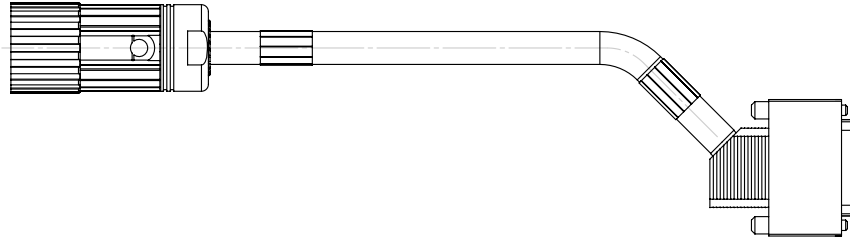

64042AXX

Motor size	Encoder type	Encoder cable	
		Installation	Part number
DR315	EH7S	 56047AXX	1360 265 9
		 56048AXX	1362 320 6

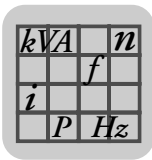

Technical Data
Prefabricated cables

- Encoder connection:
 - AS7Y to motors DR71 ... 132
 - AG7Y to motors DR160 ... 225
 - AH7Y to DR315 motor

Required prefabricated cables:

- Possibility 1: Y-cable with D-sub 15 plug connector, D-sub 9 plug connector and encoder connection cover:

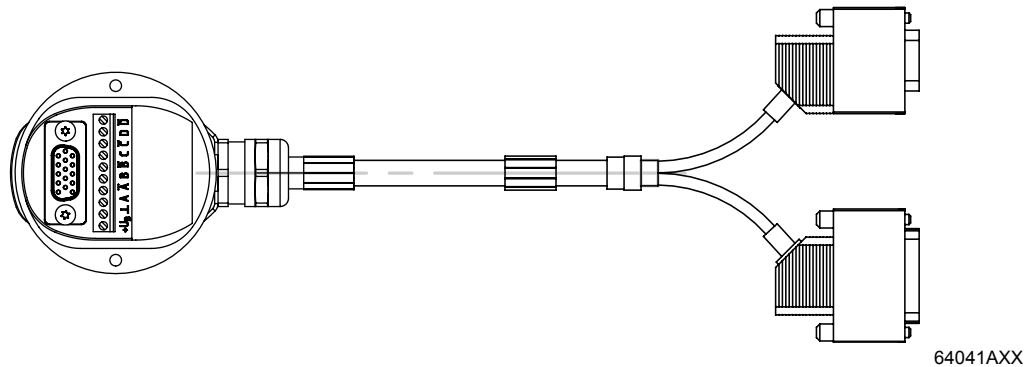

- Possibility 2: Y-cable with D-sub 15 plug connector, D-sub 9 plug connector and conductor end sleeves:

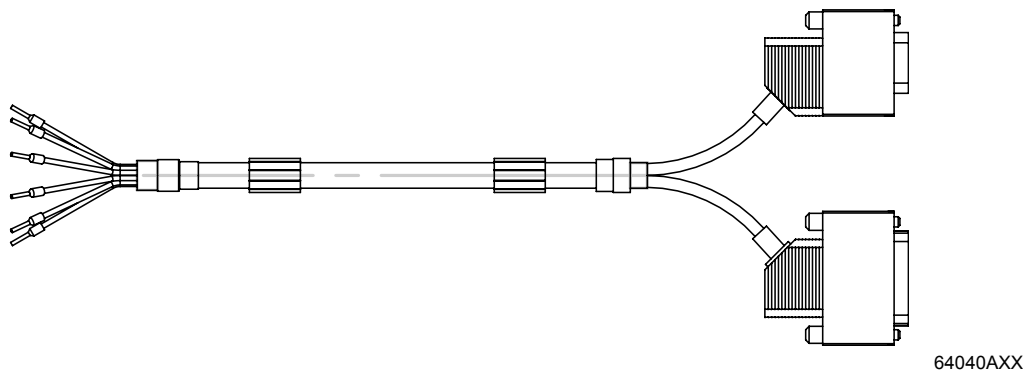

Motor size	Encoder type	Encoder cable	
		Installation	Part number
DR71 ... 132 DR160 ... 225	AS7Y AG7Y	 64134AXX	1362 629 9
		 64151AXX	1362 630 2
DR71 ... 132 DR160 ... 225 DR315	AS7Y AG7Y AH7Y	 64083AXX	1360 264 0
		 64082AXX	1362 326 5



3 Motor Selection

3.1 Basic recommendations for motor selection

- Only use motors with at least thermal class 155 (F).
- Use TF thermistors or TH winding thermostats. TH should be preferred for group drives on one inverter. The series connection of the TH contacts (normally closed) is not subject to limitation when both monitoring functions are used.
- For group drives, we recommend that the motors should not differ from one another by more than 3 motor types.
- Use 4-pole motors if possible. This recommendation particularly applies to gear-motors that are operated with a high oil filling level due to their vertical mounting position.
- Generally speaking, the motor can be operated at its listed power without forced cooling if the operating conditions differ from S1 operation, e.g. positioning drive with 1:20 speed range in S3 operation.
- Do not select a motor that is too big, particularly for delta connection. Otherwise, the inverter may trigger a short circuit fault.
- A MOVIDRIVE® MDX61B with HIPERFACE® encoder card type DEH11B option or with DER11B resolver card option is required for speed control. In this case, the motor must be equipped with an encoder (HIPERFACE®, sin/cos or TTL) or resolver.

3.2 Motor selection for asynchronous AC motors (VFC)

Voltage/frequency characteristic curve

The operating mode VFC runs the asynchronous motor on a load-dependent voltage/frequency curve. The continuous calculation of the motor model enables the full motor torque to be utilized right down to the lowest speeds. This characteristic curve is set by entering the rated motor voltage and the rated motor frequency in the startup function. The setting determines the speed-dependent torque and power characteristics of the asynchronous motor.

The following figure shows an example of the voltage/frequency characteristic curves of an asynchronous AC motor 230/400 V, 50 Hz.

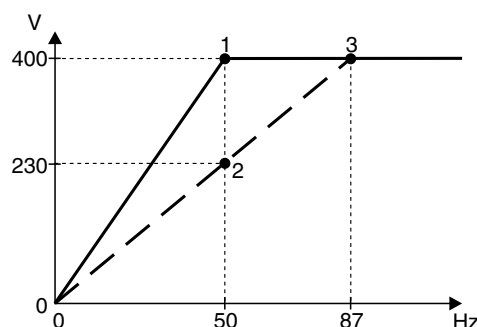

Figure 1: Voltage/frequency characteristic curve of the asynchronous motor

63199AXX

- 1 Star connection; 400 V, 50 Hz
- 2 Delta connection: 230 V, 50 Hz
- 3 Delta connection: 400 V, 87 Hz



Motor Selection

Motor selection for asynchronous AC motors (VFC)

The inverter output voltage V_{out} is limited by the connected supply voltage. The "rated supply voltage" input value in the startup function limits the effective value of the maximum output voltage. This restriction is used whenever the connected motor has a lower rated voltage than the power supply of the inverter. Enter the maximum permitted motor voltage. Furthermore, make sure that the "rated supply voltage" input value is less than or equal to the supply voltage of the inverter.

Speed/torque characteristics

The field weakening range starts when the set maximum output voltage of the inverter is reached. Consequently, the speed range of the motor is divided into two ranges:

- Basic speed range → constant torque with increasing power
- Field weakening range → constant power with an inversely proportionate decrease in torque.

When determining the maximum speed in the field weakening range, note that the rated torque M_N (in relation to the rated speed, e.g. $n_N = 1500$ rpm) falls in inverse proportion and the breakdown torque M_K is reduced in an inverse quadratic relationship. The M_K/M_N ratio is a motor-specific parameter. The MOVIDRIVE® stall protection limits the speed when the maximum possible torque is reached.

The following figure shows an example of different motor characteristic curves in the basic speed range and in the field weakening range.

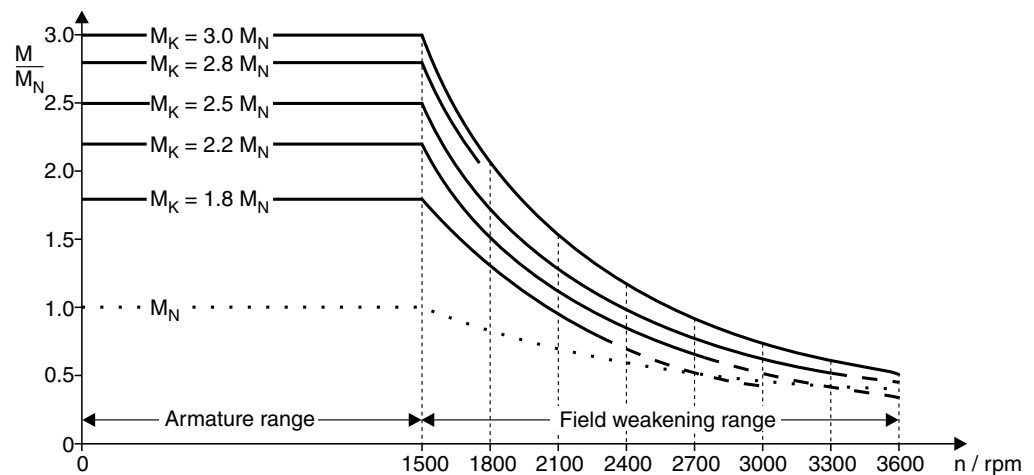

Figure 2: Quadratically falling breakdown torque

01729BEN

With gearmotors, the maximum motor speed depends on the size and mounting position of the gear unit. The speed should not exceed 3000 rpm due to the resulting noise and oil churning losses.



Typical speed/torque characteristic curve

M_N is determined by the motor. M_{max} and n_{trans} depend on the motor/inverter combination. You can refer to the motor selection tables for CFC mode for the values of n_{trans} , M_N and M_{max} .

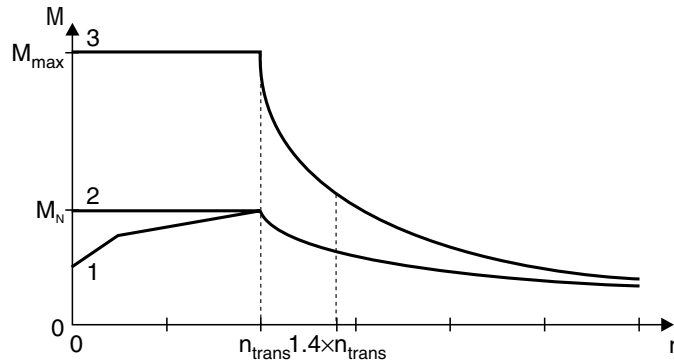

Figure 3: Speed/torque characteristic curve in CFC operating mode

01651BEN

- [1] With integrated cooling
- [2] With forced cooling
- [3] Maximum torque

Dynamic applications
 ($P_{inverter}$ greater than P_{motor})

Observe the following notes for dynamic applications in which the inverter power is significantly greater than the motor power:

- The startup function sets the current limit of the inverter (P303/P313) to 150 % of the rated motor current. The value of the current limit is based on the rated inverter current. As a result, 150 % of the rated motor current is less than 150 % of the rated inverter current (value of P303/P313). For dynamic applications, this parameter must be manually set to a higher value.
- The startup function sets the slip compensation parameter (P324/P334) to the rated slip of the motor. In the case of VFC-n-CONTROL, the internal slip limiting function allows the slip to reach max. 150 % of this setting. Consequently, the motor develops at most 150 % of the rated motor torque. For higher torque ratings, the slip compensation parameter (P324) must be increased accordingly.

	NOTE
	Set parameter P324 "Slip compensation" to max. 130 % of the rated slip of the motor for stable operation.

Combinations with $P_{inverter}$ greater than $4 \times P_{motor}$

For inverter/motor combinations in which the inverter power is greater than four times the motor power, special measures must be taken during project planning and startup. The reason for this is the large difference between the rated inverter current and the rated motor current.

Therefore, note the following measures:

- Perform project planning for connecting the motor in a delta connection. This increases the motor current by a factor of $\sqrt{3}$ and lowers the unfavorable ratio.
- If this measure does not suffice, start up the motor in VFC & GROUP or V/f operating mode. In these operating modes, the inverter simulates a supply system with constant voltage and frequency with a constant V/f ratio.



Motor Selection

Motor selection for asynchronous AC motors (VFC)

DRS motor selection with delta/star connection type (AC 230/400 V / 50 Hz)

Motors for AC 380 V / 60 Hz can also be allocated on the basis of this selection table.

P _{max} in kW (HP) for operation on MOVIDRIVE® MDX60/61B...-5_3 (AC 400/500 V units)								
Connection		Δ / AC 400 V ¹⁾			Δ / AC 230 V ²⁾			
Cooling		Own		Forced		Own	Forced	
f _{min} - f _{max}	Hz	10 - 50 / 6 - 60 5 - 70 / 5.5 - 80		≤ 2.5 - 50 / ≤ 3 - 60 ³⁾		9 - 87	≤ 2.5 - 87 ³⁾	
n _{min} - n _{max}	rpm	300 - 1500 / 180 - 1800 150 - 2100 / 165 - 2400		≤ 75 - 1500 / ≤ 90 - 1800		270 - 2610	≤ 75 - 2610	
Speed range		1:5 / 1:10 / 1:15		≥ 1:20		1:10	≥ 1:20	
Motor type	Rated power P _n kW (HP)	P = P _{reduced}		P = P _n		P = P _{increased}		
		kW (HP)	MDX ⁴⁾ 60/61B...-5_3	kW (HP)	MDX ⁴⁾ 60/61B...-5_3	kW (HP)	MDX ⁴⁾ 60/61B...-5_3	
DRS71S4	0.37 (0.5)	0.25 (0.34)	0005/0015	0.37 (0.5)	0005/0015	0.55 (0.74)	0005/0015	
DRS71M4	0.55 (0.74)	0.37 (0.5)		0.55 (0.74)		0008/0015	0.75 (1.0)	0008/0015
DRS80S4	0.75 (1.0)	0.55 (0.74)		0.75 (1.0)		0011/0015	1.1 (1.5)	0011/0015
DRS80M4	1.1 (1.5)	0.75 (1.0)	0008/0015	1.1 (1.5)	0011/0015	1.5 (2.0)	0014/0015	
DRS90M4	1.5 (2.0)	1.1 (1.5)	0011/0015	1.5 (2.0)	0014/0015	2.2 (3.0)	0022	
DRS90L4	2.2 (3.0)	1.5 (2.0)	0014/0015	2.2 (3.0)	0022	3.0 (4.0)	0030	
DRS100M4	3.0 (4.0)	2.2 (3.0)	0022	3.0 (4.0)	0030	4.0 (5.4)	0040	
DRS100LC4	4.0 (5.4)	3.0 (4.0)	0030	4.0 (5.4)	0040	5.5 (7.4)	0055	
DRS112M4								
DRS132S4	5.5 (7.4)	4.0 (5.4)	0040	5.5 (7.4)	0055	7.5 (10)	0075	
DRS132M4	7.5 (10)	5.5 (7.4)	0055	7.5 (10)	0075	9.2 (12)	0110	
DRS132MC4	9.2 (12)	7.5 (10)	0075	9.2 (12)	0110	11 (15)		
DRS160S4								
DRS160M4	11 (15)	9.2 (12)	0110	11 (15)	0150	15 (20)	0150	
DRS160MC4	15 (20)	11 (15)		15 (20)		0150		18.5 (24.8)
DRS180S4 ⁵⁾								
DRS180M4 ⁵⁾	18.5 (24.8)	15 (20)	0150	18.5 (24.8)	0220	22 (30)	0220	
DRS180L4 ⁵⁾	22 (30)	18.5 (24.8)	0220	22 (30)		30 (40)		0300
DRS180LC4 ⁵⁾	30 (40)	22 (30)		30 (40)	0300	37 (50)	0370	
DRS200L4 ⁶⁾								
DRS225S4 ⁶⁾	37 (50)	30 (40)	0300	37 (50)	0370	45 (60)	0450	
DRS225M4 ⁶⁾	45 (60)	37 (50)	0370	45 (60)	0450	55 (74)	0550	
DRS225MC4 ⁶⁾	55 (74)	45 (60)	0450	55 (74)	0550	75 (100)	0750	
DRS315K4 ⁷⁾	110 (148)	90 (120)	0900	110 (148)	1100	132 (177)	1320	
DRS315S4 ⁷⁾	132 (177)	110 (148)	1100	132 (177)	1320			
DRS315M4 ⁷⁾	160 (215)	132 (177)	1320					

1) Also applies to motors with AC 460 V or AC 500 V rated voltage and for AC 400/690 V motors in Δ connection.

2) Also applies to motors with AC 266 V or AC 290 V rated voltage.

3) Without speed control: f_{min} = 0.5 Hz

4) In each application, the units listed here permit intermittent loads of up to two times the rated load with size 0 (0005 ... 0014) and up to 1.5 times the rated load with sizes 1 ... 6 (0015 ... 1320). With variable torque load and constant load without overload, each inverter can also be operated with an increased continuous output power (→ MDX60B/61B catalog, Technical Data chapter). The continuous output current of 125 % of the rated unit current is only available at f_{PWM} = 4 kHz.

5) Maximum permitted motor speed n_{max} = 3400 rpm

6) Maximum permitted motor speed n_{max} = 3000 rpm

7) Maximum permitted motor speed n_{max} = 2600 rpm



DRE motor selection with delta/star connection type (AC 230/400 V / 50 Hz)

Motors for AC 380 V / 60 Hz can also be allocated on the basis of this selection table.

P _{max} in kW (HP) for operation on MOVIDRIVE® MDX60/61B...-5_3 (AC 400/500 V units)							
Connection		Δ / AC 400 V ¹⁾				Δ / AC 230 V ²⁾	
Cooling		Own		Forced		Own	Forced
f _{min} - f _{max}	Hz	10 - 50 / 6 - 60 5 - 70 / 5.5 - 80		≤ 2.5 - 50 / ≤ 3 - 60 ³⁾		9 - 87	≤ 2.5 - 87 ³⁾
n _{min} - n _{max}	rpm	300 - 1500 / 180 - 1800 150 - 2100 / 165 - 2400		≤ 75 - 1500 / ≤ 90 - 1800		270 - 2610	≤ 75 - 2610
Speed range		1:5 / 1:10 / 1:15		≥ 1:20		1:10	≥ 1:20
Motor type	Rated power P _n kW (HP)	P = P _{reduced}		P = P _n		P = P _{increased} ⁴⁾	
		kW (HP)	MDX ⁵⁾ 60/61B...-5_3	kW (HP)	MDX ⁴⁾ 60/61B...-5_3	kW (HP)	MDX ⁴⁾ 60/61B...-5_3
DRE80M4	0.75 (1.0)	0.55 (0.74)	0005/0015	0.75 (1.0)	0008/0015	1.1 (1.5)	0011/0015
DRE90M4	1.1 (1.5)	0.75 (1.0)	0008/0015	1.1 (1.5)	0011/0015	1.5 (2.0)	0014/0015
DRE90L4	1.5 (2.0)	1.1 (1.5)	0011/0015	1.5 (2.0)	0014/0015	2.2 (3.0)	0022
DRE100M4	2.2 (3.0)	1.5 (2.0)	0014/0015	2.2 (3.0)	0022	3.0 (4.0)	0030
DRE100LC4	3.0 (4.0)	2.2 (3.0)	0022	3.0 (4.0)	0030	4.0 (5.4)	0040
DRE112M4							
DRE132S4	4.0 (5.4)	3.0 (4.0)	0030	4.0 (5.4)	0040	5.5 (7.4)	0055
DRE132M4	5.5 (7.4)	4.0 (5.4)	0040	5.5 (7.4)	0055	7.5 (10)	0075
DRE132MC4	7.5 (10)	5.5 (7.4)	0055	7.5 (10)	0075	9.2 (12)	0110
DRE160S4							
DRE160M4	9.2 (12)	7.5 (10)	0075	9.2 (12)	0110	11 (15)	0150
DRE160MC4	11 (15)	9.2 (12)	0110	11 (15)	0150	18.5 (24.8)	0220
DRE180S4 ⁶⁾							
DRE180M4 ⁵⁾	15 (20)	11 (15)	0150	15 (20)	0220	22 (30)	0300
DRE180L4 ⁵⁾	18.5 (24.8)	15 (20)	0150	18.5 (24.8)	0300	30 (40)	0370
DRE180LC4 ⁵⁾	22 (30)	18.5 (24.8)	0220	22 (30)	0370	45 (60)	0450
DRE200L4 ⁷⁾							
DRE225S4 ⁶⁾	30 (40)	22 (30)	0300	30 (40)	0450	55 (74)	0550
DRE225M4 ⁶⁾	37 (50)	30 (40)	0300	37 (50)	0370	132 (177)	1320
DRE225MC4 ⁶⁾	45 (60)	37 (50)	0370	45 (60)	0450		
DRE315K4 ⁸⁾	110 (148)	90 (120)	0900	110 (148)	1100		
DRE315S4 ⁷⁾	132 (177)	110 (148)	1100	132 (177)	1320		
DRE315M4 ⁷⁾	160 (215)	132 (177)	1320				

- 1) Also applies to motors with AC 460 V or AC 500 V rated voltage and for AC 400/690 V motors in Δ connection.
- 2) Also applies to motors with AC 266 V or AC 290 V rated voltage.
- 3) Without speed control: f_{min} = 0.5 Hz
- 4) The motor is operated at the power of the next larger motor (1 frame size), not with the √3-fold power.
- 5) In each application, the units listed here permit intermittent loads of up to two times the rated load with size 0 (0005 ... 0014) and up to 1.5 times the rated load with sizes 1 ... 6 (0015 ... 1320). With variable torque load and constant load without overload, each inverter can also be operated with an increased continuous output power (→ MDX60B/61B catalog, Technical Data chapter). The continuous output current of 125 % of the rated unit current is only available at f_{PWM} = 4 kHz.
- 6) Maximum permitted motor speed n_{max} = 3400 rpm
- 7) Maximum permitted motor speed n_{max} = 3000 rpm
- 8) Maximum permitted motor speed n_{max} = 2600 rpm



Motor Selection

Motor selection for asynchronous AC motors (VFC)

DRP motor selection with delta/star connection type (AC 230/400 V / 50 Hz)

Motors for AC 380 V / 60 Hz can also be allocated on the basis of this selection table.

P _{max} in kW (HP) for operation on MOVIDRIVE® MDX60/61B...-5_3 (AC 400/500 V units)							
Connection		Δ / AC 400 V ¹⁾				Δ / AC 230 V ²⁾	
Cooling		Own		Forced		Own	Forced
f _{min} - f _{max}	Hz	10 - 50 / 6 - 60 5 - 70 / 5.5 - 80		≤ 2.5 - 50 / ≤ 3 - 60 ³⁾		9 - 87	≤ 2.5 - 87 ³⁾
n _{min} - n _{max}	rpm	300 - 1500 / 180 - 1800 150 - 2100 / 165 - 2400		≤ 75 - 1500 / ≤ 90 - 1800		270 - 2610	≤ 75 - 2610
Speed range		1:5 / 1:10 / 1:15		≥ 1:20		1:10	≥ 1:20
Motor type	Rated power P _n kW (HP)	P = P _{reduced}		P = P _n		P = P _{increased} ⁴⁾	
		kW (HP)	MDX ⁵⁾ 60/61B...-5_3	kW (HP)	MDX ⁴⁾ 60/61B...-5_3	kW (HP)	MDX ⁴⁾ 60/61B...-5_3
DRP90M4	0.75 (1.0)	0.55 (0.74)	0005/0015	0.75 (1.0)	0008/0015	1.1 (1.5)	0011/0015
DRP90L4	1.1 (1.5)	0.75 (1.0)	0008/0015	1.1 (1.5)	0011/0015	1.5 (2.0)	0014/0015
DRP100M4	1.5 (2.0)	1.1 (1.5)	0011/0015	1.5 (2.0)	0014/0015	2.2 (3.0)	0022
DRP100L4	2.2 (3.0)	1.5 (2.0)	0014/0015	2.2 (3.0)	0022	3.0 (4.0)	0030
DRP112M4	3.0 (4.0)	2.2 (3.0)	0022	3.0 (4.0)	0030	4.0 (5.4)	0040
DRP132M4	4.0 (5.4)	3.0 (4.0)	0030	4.0 (5.4)	0040	5.5 (7.4)	0055
DRP132MC4	5.5 (7.4)	4.0 (5.4)	0040	5.5 (7.4)	0055	7.5 (10)	0075
DRP160S4							
DRP160M4	7.5 (10)	5.5 (7.4)	0055	7.5 (10)	0075	9.2 (12)	0110
DRP160MC4	9.2 (12)	7.5 (10)	0075	9.2 (12)	0110	11 (15)	0150
DRP180S4 ⁶⁾							
DRP180M4 ⁵⁾	11 (15)	9.2 (12)	0110	11 (15)	0150	15 (20)	0220
DRP180L4 ⁵⁾	15 (20)	11 (15)	0150	15 (20)	0220	18.5 (24.8)	0300
DRP180LC4 ⁵⁾	18.5 (24.8)	15 (20)	0150	18.5 (24.8)	0220	22 (30)	0370
DRP200L4 ⁷⁾							
DRP225S4 ⁶⁾	22 (30)	18.5 (24.8)	0220	22 (30)	0300	30 (40)	0450
DRP225M4 ⁶⁾	30 (40)	22 (30)	0300	30 (40)	0370	37 (50)	1100
DRP225MC4 ⁶⁾	37 (50)	30 (40)	0370	37 (50)	0900	45 (60)	1320
DRP315K4 ⁸⁾	90 (120)	75 (100)	0750	90 (120)	0900	110 (148)	1320
DRP315S4 ⁷⁾	110 (148)	90 (120)	0900	110 (148)	1100	132 (177)	1320
DRP315M4 ⁷⁾	132 (177)	110 (148)	1100	132 (177)	1320		
DRP315L4 ⁷⁾	160 (215)	132 (177)	1320				

1) Also applies to motors with AC 460 V or AC 500 V rated voltage and for AC 400/690 V motors in Δ connection.

2) Also applies to motors with AC 266 V or AC 290 V rated voltage.

3) Without speed control: f_{min} = 0.5 Hz

4) The motor is operated at the power of the next larger motor (1 frame size), not with the $\sqrt{3}$ -fold power.

5) In each application, the units listed here permit intermittent loads of up to two times the rated load with size 0 (0005 ... 0014) and up to 1.5 times the rated load with sizes 1 ... 6 (0015 ... 1320). With variable torque load and constant load without overload, each inverter can also be operated with an increased continuous output power (→ MDX60B/61B catalog, Technical Data chapter). The continuous output current of 125 % of the rated unit current is only available at f_{PWM} = 4 kHz.

6) Maximum permitted motor speed n_{max} = 3400 rpm

7) Maximum permitted motor speed n_{max} = 3000 rpm

8) Maximum permitted motor speed n_{max} = 2600 rpm



Examples for motor selection delta/star AC 230/400 V

Trolley drive



Constant load with overload (acceleration) and low load during travel:

- $P_{\text{travel}} = 1.3 \text{ kW}$
- $P_{\text{max}} = 13 \text{ kW}$
- $n_{\text{min}} = 270 \text{ rpm}$, setting range 1:10
- $n_{\text{max}} = 2610 \text{ rpm}$

In inverter mode with adapted power ($P = P_n$), the motor can output 150 % of its listed power during the acceleration phase. This means:

$$P_{\text{Mot}} = P_{\text{max}} : 1.5 = 13 \text{ kW} : 1.5 = 8.67 \text{ kW}$$

A DRS132M4 motor with delta connection ($P_n = 9.2 \text{ kW}$) is selected.

According to the selection table (→ page 18) a MOVIDRIVE® MDX61B0110 ($P = P_n$) is allocated.

Hoist drive



High constant load with short-term overload (acceleration):

- $P_{\text{max}} = 26 \text{ kW}$
- $P_{\text{const.}} = 20 \text{ kW}$
- Setting range 1:15, low speed only for positioning
- Brake applied when the drive is at a standstill
- Load type S3 (40 % c.d.f.)

The inverter can deliver 150 % of its rated current during acceleration. Consequently, a MOVIDRIVE® MDX61B0220 is selected.

In view of the duty type (S3, 40 % cdf), the selection table allocates motor type DRS180L4 ($P_n = 22 \text{ kW}$) in a star connection.

For more information, refer to the 'Project planning for hoists' chapter

Fan/pump



Variable torque load with the following power values:

- $P_{\text{max}} = 4.8 \text{ kW}$
- $n_{\text{max}} = 1400 \text{ rpm}$, continuous duty with n_{max}

The motor can be operated at its listed power ($P = P_n$) even without forced cooling due to the quadratically falling torque. Therefore, the motor type DRS132S4 in star connection ($P_n = 5.5 \text{ kW}$) is sufficient.

The selection table allocates a MOVIDRIVE® MDX61B0055 ($P = P_n$). However, as there is a variable torque load without overload, the inverter can be operated with increased output power. Consequently, a MOVIDRIVE® MDX61B0040 is sufficient.



Motor Selection

Motor selection for asynchronous AC motors (VFC)

DRS motor selection in delta connection type (AC 230 V / 50 Hz)

P _{max} kW (HP) for operation on MOVIDRIVE® MDX61B...-2_3 (AC 230 V units)					
Connection		Δ / AC 230 V			
Cooling		Own	Forced		
f _{min} - f _{max}	Hz	10 - 50 6 - 60 5 - 70 / 5.5 - 80	≤ 2.5 - 50 / ≤ 3 - 60 ¹⁾		
n _{min} - n _{max}	rpm	300 - 1500 180 - 1800 150 - 2100 / 165 - 2400	≤ 75 - 1500 / ≤ 90 - 1800		
Speed range		1:5 1:10 1:15	≥ 1:20		
Motor type	Rated power P _n kW (HP)	P = P _{reduced} kW (HP) with MDX61B...-2_3 ²⁾		P = P _n kW (HP) with MDX61B...-2_3	
DRS71S4	0.37 (0.5)	0.25 (0.34)	0015	0.37 (0.5)	0015
DRS71M4	0.55 (0.74)	0.37 (0.5)		0.55 (0.74)	
DRS80S4	0.75 (1.0)	0.55 (0.74)		0.75 (1.0)	
DRS80M4	1.1 (1.5)	0.75 (1.0)		1.1 (1.5)	
DRS90M4	1.5 (2.0)	1.1 (1.5)		1.5 (2.0)	
DRS90L4	2.2 (3.0)	1.5 (2.0)	0022	2.2 (3.0)	0022
DRS100M4	3.0 (4.0)	2.2 (3.0)	0022	3.0 (4.0)	0037
DRS100LC4	4.0 (5.4)	3.0 (4.0)	0037	4.0 (5.4)	0055
DRS112M4					
DRS132S4	5.5 (7.4)	4.0 (5.4)	0055	5.5 (7.4)	0075
DRS132M4	7.5 (10)	5.5 (7.4)		7.5 (10)	
DRS132MC4	9.2 (12)	7.5 (10)	0075	9.2 (12)	0110
DRS160S4					
DRS160M4	11 (15)	9.2 (12)	0110	11 (15)	0150
DRS160MC4	15 (20)	11 (15)		15 (20)	
DRS180S4	18.5 (24.8)	15 (20)	0150	18.5 (24.8)	0220
DRS180M4					
DRS180L4	22 (30)	18.5 (24.8)	0220	22 (30)	0300
DRS180LC4	30 (40)	22 (30)		30 (40)	
DRS200L4	37 (50)	30 (40)	0300	-	-
DRS225S4					

1) Without speed control: f_{min} = 0.5 Hz

2) The units listed here permit intermittent loads of up to 1.5 times the rated load in the specific application. With variable torque load and constant load without overload, each inverter can also be operated with an increased continuous output power (→ MDX60B/61B catalog, Technical Data chapter). The continuous output current of 125 % of the rated unit current is only available at f_{PWM} = 4 kHz.



DRE motor selection in delta connection type (AC 230 V / 50 Hz)

P _{max} kW (HP) for operation on MOVIDRIVE® MDX61B...-2_3 (AC 230 V units)					
Connection		Δ / AC 230 V			
Cooling		Own		Forced	
f _{min} - f _{max}	Hz	10 - 50 6 - 60 5 - 70 / 5.5 - 80		≤ 2.5 - 50 / ≤ 3 - 60 ¹⁾	
n _{min} - n _{max}	rpm	300 - 1500 180 - 1800 150 - 2100 / 165 - 2400		≤ 75 - 1500 / ≤ 90 - 1800	
Speed range		1:5 1:10 1:15		≥ 1:20	
Motor type	Rated power P _n kW (HP)	P = P _{reduced} kW (HP) with MDX61B...-2_3 ²⁾		P = P _n kW (HP) with MDX61B...-2_3 ³⁾	
DRE80M4	0.75 (1.0)	0.55 (0.74)	0015	0.75 (1.0)	0015
DRE90M4	1.1 (1.5)	0.75 (1.0)		1.1 (1.5)	
DRE90L4	1.5 (2.0)	1.1 (1.5)		1.5 (2.0)	
DRE100M4	2.2 (3.0)	1.5 (2.0)		2.2 (3.0)	
DRE100LC4	3.0 (4.0)	2.2 (3.0)	0022	3.0 (4.0)	0037
DRE112M4					
DRE132S4	4.0 (5.4)	3.0 (4.0)	0037	4.0 (5.4)	0055
DRE132M4	5.5 (7.4)	4.0 (5.4)		5.5 (7.4)	
DRE132MC4	7.5 (10)	5.5 (7.4)	0055	7.5 (10)	0075
DRE160S4					
DRE160M4	9.2 (12)	7.5 (10)	0075	9.2 (12)	0110
DRE160MC4	11 (15)	9.2 (12)		0110	
DRE180S4					
DRE180M4	15 (20)	11 (15)	0150	15 (20)	0150
DRE180L4	18.5 (24.8)	15 (20)		0150	
DRE180LC4					
DRE200L4	22 (30)	18.5 (24.8)	0220	22 (30)	0220
DRE225S4	30 (40)	22 (30)		0220	
DRE225M4			37 (50)		30 (40)

1) Without speed control: f_{min} = 0.5 Hz

2) The units listed here permit intermittent loads of up to 1.5 times the rated load in the specific application. With variable torque load and constant load without overload, each inverter can also be operated with an increased continuous output power (→ MDX60B/61B catalog, Technical Data chapter). The continuous output current of 125 % of the rated unit current is only available at f_{PVM} = 4 kHz.



Motor Selection

Motor selection for asynchronous AC motors (VFC)

DRP motor selection in delta connection type (AC 230 V / 50 Hz)

P _{max} kW (HP) for operation on MOVIDRIVE® MDX61B...-2_3 (AC 230 V units)					
Connection		Δ / AC 230 V			
Cooling		Own		Forced	
f _{min} - f _{max}	Hz	10 - 50 6 - 60 5 - 70 / 5.5 - 80		≤ 2.5 - 50 / ≤ 3 - 60 ¹⁾	
n _{min} - n _{max}	rpm	300 - 1500 180 - 1800 150 - 2100 / 165 - 2400		≤ 75 - 1500 / ≤ 90 - 1800	
Speed range		1:5 1:10 1:15		≥ 1:20	
Motor type	Rated power P _n kW (HP)	P = P _{reduced} kW (HP) with MDX61B...-2_3 ²⁾		P = P _n kW (HP) with MDX61B...-2_3 ³⁾	
DRP90M4	0.75 (1.0)	0.55 (0.74)	0015	0.75 (1.0)	0015
DRP90L4	1.1 (1.5)	0.75 (1.0)		1.1 (1.5)	
DRP100M4	1.5 (2.0)	1.1 (1.5)		1.5 (2.0)	
DRP100L4	2.2 (3.0)	1.5 (2.0)		2.2 (3.0)	
DRP112M4	3.0 (4.0)	2.2 (3.0)	0022	3.0 (4.0)	0037
DRP132M4	4.0 (5.4)	3.0 (4.0)	0037	4.0 (5.4)	0055
DRP132MC4	5.5 (7.4)	4.0 (5.4)	0055	5.5 (7.4)	
DRP160S4					
DRP160M4	7.5 (10)	5.5 (7.4)		7.5 (10)	0075
DRP160MC4	9.2 (12)	7.5 (10)	0075	9.2 (12)	0110
DRP180S4					
DRP180M4	11 (15)	9.2 (12)	0110	11 (15)	
DRP180L4	15 (20)	11 (15)		15 (20)	0150
DRP180LC4	18.5 (24.8)	15 (20)	0150	18.5 (24.8)	0220
DRP200L4					
DRP225S4	22 (30)	18.5 (24.8)	0220	22 (30)	
DRP225M4	30 (40)	22 (30)		30 (40)	0300
DRP225MC4	37 (50)	30 (40)	0300	-	-

1) Without speed control: f_{min} = 0.5 Hz

2) The units listed here permit intermittent loads of up to 1.5 times the rated load in the specific application. With variable torque load and constant load without overload, each inverter can also be operated with an increased continuous output power (→ MDX60B/61B catalog, Technical Data chapter). The continuous output current of 125 % of the rated unit current is only available at f_{PWM} = 4 kHz.



DRS motor selection in double-star/star connection type (AC 230/460 V / 60 Hz)

P _{max} in kW (HP) for operation on MOVIDRIVE® MDX60/61B...-5_3 (AC 400/500 V units)							
Connection		Δ / AC 460 V			ΔΔ / AC 230 V		
Cooling		Own	Own	Forced	Own	Forced	
f _{min} - f _{max}	Hz	6 - 90	10 - 60	0 - 60 ¹⁾	10 - 120	0 - 120 ¹⁾	
n _{min} - n _{max}	rpm	180 - 2700	300 - 1800	0 - 1800	300 - 3600	0 - 3600	
Speed range		1:15	1:6	≥ 1:15	1:12	≥ 1:20	
Motor type	Rated power P _n kW (HP)	P = P _{reduced}		P = P _n		P = P _{increased} ²⁾	
		kW (HP)	With MDX60/61B...-5_3 ³⁾	kW (HP)	With MDX60/61B...-5_3 ³⁾	kW (HP)	With MDX60/61B...-5_3 ³⁾
DRS71S4	0.37 (0.5)	0.25 (0.34)	0005/0015	0.37 (0.5)	0005/0015	0.75 (1.0)	0008/0015
DRS71M4	0.55 (0.74)	0.37 (0.5)		0.55 (0.74)		1.1 (1.5)	0011/0015
DRS80S4	0.75 (1.0)	0.55 (0.74)		0.75 (1.0)		0008/0015	1.5 (2.0)
DRS80M4	1.1 (1.5)	0.75 (1.0)	0008/0015	1.1 (1.5)	0011/0015	2.2 (3.0)	0022
DRS90M4	1.5 (2.0)	1.1 (1.5)	0011/0015	1.5 (2.0)	0014/0015	3.0 (4.0)	0030
DRS90L4	2.2 (3.0)	1.5 (2.0)	0014/0015	2.2 (3.0)	0022	4.0 (5.4)	0040
DRS100M4	3.7 (5.0)	2.2 (3.0)	0022	3.7 (5.0)	0040	5.5 (7.4)	0055
DRS100L4	4.0 (5.4)	3.0 (4.0)	0030	4.0 (5.4)		7.5 (10)	0075
DRS112M4							
DRS132S4	5.5 (7.4)	4.0 (5.4)	0040	5.5 (7.4)	0055	9.2 (12)	0110
DRS132M4	7.5 (10)	5.5 (7.4)	0055	7.5 (10)	0075	11 (15)	
DRS132MC4	9.2 (12)	7.5 (10)	0075	9.2 (12)	0110	15 (20)	0150
DRS160S4							
DRS160M4	11 (15)	9.2 (12)	0110	11 (15)	0150	18.5 (24.8)	0220
DRS160MC4	15 (20)	11 (15)		15 (20)		22 (30)	
DRS180S4 ⁴⁾							
DRS180M4 ⁴⁾	18.5 (24.8)	15 (20)	0150	18.5 (24.8)	0220	30 (40)	0300
DRS180L4 ⁴⁾	22 (30)	18.5 (24.8)	0220	22 (30)	0300	37 (50)	0370
DRS180LC4 ⁴⁾				30 (40)		45 (60)	0450
DRS200L4 ⁵⁾							
DRS225S4 ⁵⁾	37 (50)	30 (40)	0300	37 (50)	0370	55 (74)	0550
DRS225M4 ⁵⁾	45 (60)	37 (50)	0370	45 (60)	0450	75 (100)	0750
DRS225MC4 ⁵⁾	55 (74)	45 (60)	0450	55 (74)	0550	90 (120)	0900
DRS315K4 ⁶⁾	110 (148)	90 (120)	0900	110 (148)	1100		
DRS315S4 ⁶⁾	132 (177)	110 (148)	1100	132 (177)	1320		
DRS315M4 ⁶⁾	160 (215)	132 (177)	1320				

- 1) Without speed control: f_{min} = 0.5 Hz
- 2) P_{increased} means that the motor is operated with increased power (not always with twice the power).
- 3) In each application, the units listed here permit intermittent loads of up to two times the rated load with size 0 (0005 ... 0014) and up to 1.5 times the rated load with sizes 1 ... 6 (0015 ... 1320). With variable torque load and constant load without overload, each inverter can also be operated with an increased continuous output power (see MDX60B/61B catalog, Technical Data chapter). The continuous output current of 125 % of the rated unit current is only available at f_{PWM} = 4 kHz.
- 4) Maximum permitted motor speed n_{max} = 3400 rpm
- 5) Maximum permitted motor speed n_{max} = 3000 rpm
- 6) Maximum permitted motor speed n_{max} = 2600 rpm



Motor Selection

Motor selection for asynchronous AC motors (VFC)

DRE motor selection in double-star/star connection type (AC 230/460 V / 60 Hz)

P _{max} in kW (HP) for operation on MOVIDRIVE® MDX60/61B...-5_3 (AC 400/500 V units)							
Connection		Δ / AC 460 V			ΔΔ / AC 230 V		
Cooling		Own	Own	Forced	Own	Forced	
f _{min} - f _{max}	Hz	6 - 90	10 - 60	0 - 60 ¹⁾	10 - 120	0 - 120 ¹⁾	
n _{min} - n _{max}	rpm	180 - 2700	300 - 1800	0 - 1800	300 - 3600	0 - 3600	
Speed range		1:15	1:6	≥ 1:15	1:12	≥ 1:20	
Motor type	Rated power P _n kW (HP)	P = P _{reduced}		P = P _n		P = P _{increased} ²⁾	
		kW (HP)	With MDX60/61B...- 5_3 ³⁾	kW (HP)	With MDX60/61B...- 5_3 ³⁾	kW (HP)	With MDX60/61B...- 5_3 ³⁾
DRE80M4	0.75 (1.0)	0.55 (0.74)	0005/0015	0.75 (1.0)	0008/0015	1.5 (2.0)	0014/0015
DRE90M4	1.1 (1.5)	0.75 (1.0)	0008/0015	1.1 (1.5)	0011/0015	2.2 (3.0)	0022
DRE90L4	1.5 (2.0)	1.1 (1.5)	0011/0015	1.5 (2.0)	0014/0015	3.0 (4.0)	0030
DRE100L4	2.2 (3.0)	1.5 (2.0)	0014/0015	2.2 (3.0)	0022	4.0 (5.4)	0040
DRE100LC4	3.7 (5.0)	2.2 (3.0)	0022	3.7 (5.0)	0040	5.5 (7.4)	0055
DRE112M4	3.7 (5.0)						
DRE132M4	5.5 (7.4)	4.0 (5.4)	0040	5.5 (7.4)	0055	9.2 (12)	0110
DRE132MC4	7.5 (10)	5.5 (7.4)	0055	7.5 (10)	0075	11 (15)	
DRE160S4							
DRE160M4	9.2 (12)	7.5 (10)	0075	9.2 (12)	0110	15 (20)	0150
DRE160MC4	11 (15)	9.2 (12)	0110	11 (15)		0220	18.5 (24.8)
DRE180S4 ⁴⁾							
DRE180M4 ⁴⁾	15 (20)	11 (15)	0150	15 (20)	0150	22 (30)	0300
DRE180L4 ⁴⁾	18.5 (24.8)	15 (20)		18.5 (24.8)		30 (40)	
DRE180LC4 ⁴⁾	22 (30)	18.5 (24.8)	0220	22 (30)	0220	37 (50)	0370
DRE200L4 ⁵⁾	30 (40)	22 (30)		30 (40)		0300	45 (60)
DRE225S4 ⁵⁾	37 (50)	30 (40)	0300	37 (50)	0370	55 (74)	0550
DRE225M4 ⁵⁾	45 (60)	37 (50)	0370	45 (60)	0450	75 (100)	0750
DRE315K4 ⁶⁾	110 (148)	90 (120)	0900	110 (148)	1100		
DRE315S4 ⁶⁾	132 (177)	110 (148)	1100	132 (177)	1320		
DRE315M4 ⁶⁾	160 (215)	132 (177)	1320				

1) Without speed control: f_{min} = 0.5 Hz

2) P_{increased} means that the motor is operated with increased power (not always with twice the power).

3) In each application, the units listed here permit intermittent loads of up to two times the rated load with size 0 (0005 ... 0014) and up to 1.5 times the rated load with sizes 1 ... 6 (0015 ... 1320). With variable torque load and constant load without overload, each inverter can also be operated with an increased continuous output power (see MDX60B/61B catalog, Technical Data chapter). The continuous output current of 125 % of the rated unit current is only available at f_{PWM} = 4 kHz.

4) Maximum permitted motor speed n_{max} = 3400 rpm

5) Maximum permitted motor speed n_{max} = 3000 rpm

6) Maximum permitted motor speed n_{max} = 2600 rpm



DRS motor selection in double-star connection type (AC 230 V / 60 Hz)

P _{max} kW (HP) for operation on MOVIDRIVE® MDX61B...-2_3 (AC 230 V units)					
Connection		Δ / AC 230 V			
Cooling		Own	Own	Forced	
f _{min} - f _{max}	Hz	6 - 90	10 - 60	0 - 60 ¹⁾	
n _{min} - n _{max}	rpm	180 - 2700	300 - 1800	0 - 1800	
Speed range		1:15	1:6	≥ 1:15	
Motor type	Rated power P _n kW (HP)	P = P _{reduced} with MDX61B...-2_3 ²⁾		P = P _n with MDX61B...-2_3 ²⁾	
		kW (HP)		kW (HP)	
DRS71D4	0.37 (0.5)	0.25 (0.34)	0015	0.37 (0.5)	0015
DRS71M4	0.55 (0.74)	0.37 (0.5)		0.55 (0.74)	
DRS80S4	0.75 (1.0)	0.55 (0.74)		0.75 (1.0)	
DRS80M4	1.1 (1.5)	0.75 (1.0)		1.1 (1.5)	
DRS90M4	1.5 (2.0)	1.1 (1.5)		1.5 (2.0)	
DRS90L4	2.2 (3.0)	1.5 (2.0)	0220	2.2 (3.0)	0022
DRS100M4	3.7 (5.0)	2.2 (3.0)	0220	3.7 (5.0)	0037
DRS100L4	4.0 (5.4)	3.0 (4.0)	0037	4.0 (5.4)	0055
DRS112M4	5.5 (7.4)	4.0 (5.4)	0055	5.5 (7.4)	
DRS132S4	7.5 (10)	5.5 (7.4)	0055	7.5 (10)	0075
DRS132MC4	9.2 (12)	7.5 (10)	0075	9.2 (12)	0110
DRS160S4	11 (15)	9.2 (12)	0110	11 (15)	
DRS160M4	15 (20)	11 (15)	0110	15 (20)	0150
DRS180S4	18.5 (24.8)	15 (20)	0150	18.5 (24.8)	0220
DRS180M4	22 (30)	18.5 (24.8)	0220	22 (30)	
DRS180LC4	30 (40)	22 (30)	0220	30 (40)	0300
DRS200L4	37 (50)	30 (40)	0300	-	-

1) Without speed control: f_{min} = 0.5 Hz

2) The units listed here permit intermittent loads of up to 1.5 times the rated load in the specific application. With variable torque load and constant load without overload, each inverter can also be operated with an increased continuous output power (→ MDX60B/61B catalog, Technical Data chapter). The continuous output current of 125 % of the rated unit current is only available at f_{PWM} = 4 kHz.



Motor Selection

Motor selection for asynchronous AC motors (VFC)

DRE motor selection in double-star connection type (AC 230 V / 60 Hz)

P _{max} kW (HP) for operation on MOVIDRIVE® MDX61B...-2_3 (AC 230 V units)					
Connection		Δ / AC 230 V			
Cooling		Own	Own	Forced	
f _{min} - f _{max}	Hz	6 - 90	10 - 60	0 - 60 ¹⁾	
n _{min} - n _{max}	rpm	180 - 2700	300 - 1800	0 - 1800	
Speed range		1:15	1:6	≥ 1:15	
Motor type	Rated power P _n kW (HP)	P = P _{reduced} with MDX61B...-2_3 ²⁾		P = P _n with MDX61B...-2_3 ²⁾	
		kW (HP)		kW (HP)	
DRE80M4	0.75 (1.0)	0.55 (0.74)	0015	0.75 (1.0)	0015
DRE90M4	1.1 (1.5)	0.75 (1.0)		1.1 (1.5)	
DRE90I4	1.5 (2.0)	1.1 (1.5)		1.5 (2.0)	
DRE100L4	2.2 (3.0)	1.5 (2.0)		2.2 (3.0)	
DRE100LC4	3.7 (5.0)	2.2 (3.0)	0022	3.0 (4.0)	0037
DRE112M4					
DRE132M4	5.5 (7.4)	4.0 (5.4)	0055	5.5 (7.4)	0055
DRE132MC4					
DRE160S4	7.5 (10)	5.5 (7.4)	0075	7.5 (10)	0075
DRE160M4	9.2 (12)	7.5 (10)			
DRE160MC4					
DRE180S4	11 (15)	9.2 (12)	0110	11 (15)	0110
DRE180M4	15 (20)	11 (15)			
DRE180L4	18.5 (24.8)	15 (20)	0150	18.5 (24.8)	0220
DRE180LC4					
DRE200L4	30 (40)	22 (30)	0220	30 (40)	0300
DRE225S4	37 (50)	30 (40)		0300	

1) Without speed control: f_{min} = 0.5 Hz

2) The units listed here permit intermittent loads of up to 1.5 times the rated load in the specific application. With variable torque load and constant load without overload, each inverter can also be operated with an increased continuous output power (→ MDX60B/61B catalog, Technical Data chapter). The continuous output current of 125 % of the rated unit current is only available at f_{PWM} = 4 kHz.



3.3 Motor selection for asynchronous servomotors (CFC)

	NOTE
	<p>The torque limit (M limit) is set automatically by the startup function of the MOVITOOLS® operating software. Do not increase this automatically set value!</p> <p>SEW-EURODRIVE recommends always using the latest version of MOVITOOLS® for startup. The latest MOVITOOLS® version can be downloaded from our homepage (www.sew-eurodrive.com).</p>

Motor characteristics

Drives in CFC modes are characterized by their ability to control torque directly and quickly. This means it achieves a high level of dynamic overload capacity (up to $3 \times M_N$) and a very high speed and control range (up to 1:5000). Stable speed and positioning accuracy meet the high requirements of servo technology. This behavior is implemented using field-oriented control. The current components for magnetization (I_d) and torque generation (I_q) are controlled separately. One prerequisite for the CFC operating modes is that the motor must always be equipped with an encoder.

The inverter needs to know exact data about the motor connected to calculate the motor model. This data is made available by the MOVITOOLS® operating software with the startup function. CFC operating modes are only possible with 4-pole SEW-motors (DRL, DRS, DRE or DRP), not with the other SEW motors or non-SEW motors. The necessary motor data for the CFC operating modes are stored in MOVIDRIVE® for the 4-pole SEW motors.

Magnetization current

Dynamic drives that have to accelerate without delay are also energized at standstill without load. The magnetizing current I_d flows at standstill. The inverter must be able to supply this current constantly in applications in which the output stage is permanently enabled, for example in CFC & M-CONTROL mode. In particular in the case of large motors with a slip frequency ≤ 2 Hz, you have to refer to the diagrams in Sec. "Load capacity of the units at low output frequencies" to check whether the inverter can supply the current. Also check whether the thermal characteristics of the motor are suitable (forced cooling fan) for this. For the magnetization current I_d , refer to the motor tables (DRL → page 33, DRS, DRE, DRP → page 43).



Motor Selection

Motor selection for asynchronous servomotors (CFC)

CFC mode with speed control

There is no need to differentiate between the load types quadratic, dynamic and static when performing project planning for the CFC operating mode. Project planning for an asynchronous motor in CFC mode is carried out in accordance with the following requirements:

1. Effective torque requirement at average application speed.

$$M_{\text{eff}} < M_{N_mot}$$

The operating point must lie below the characteristic curve for the continuous torque (Figure 3, curve 2). If this operating point lies below the characteristic curve for forced cooling (Figure 3, curve 1), then no forced cooling is required.

2. Maximum torque needed across the speed curve.

$$M_{\text{max}} < M_{\text{dyn_mot}}$$

This operating point must lie below the characteristic curve for the maximum torque of the motor/MOVIDRIVE[®] combination (Figure 3, curve 3).

3. Maximum speed

Do not configure the maximum speed of the motor higher than 1.4 times the transition speed. The maximum torque available will then still be approx. 110 % of the continuous rated torque of the motor; also, the input speed for the gear unit connected to the motor output will still be less than 3000 rpm with delta connection.

$$n_{\text{max}} < 1.4 \times n_{\text{trans}} < 3000 \text{ rpm}$$

Cooling the motor

Self-cooling of asynchronous motors is based on the integrated fan, which means self-cooling depends on the speed. The integrated fan does not provide cooling for the motor at low speeds and standstill. Forced cooling may be necessary in case of a high static load or a high effective torque.



CFC mode with torque control (CFC & M-CONTROL)

This operating mode permits direct torque control of the asynchronous motor in the basic speed range ($n \leq n_{trans}$). The setpoint sources of the speed-controlled CFC mode can also be used for torque control. All speed setpoint sources (except for bus setpoints) are interpreted as current setpoint sources. Assign "Current" to a process data word for fieldbus control. The settings for evaluating the analog input (\rightarrow P11_, parameter description) also remain in effect. The fixed setpoints (P16_, P17_) can be entered either in the unit (rpm) or (% $I_{N_inverter}$) (\rightarrow MOVITOOLS®).

The following relationship exists between the units:

$$3000 \text{ rpm} = 150 \% \text{ rated inverter current}$$

The torque on the output shaft can then be calculated for the basic speed range ($n \leq n_{trans}$) using the following formulae:

Specification of a setpoint for the motor torque in % $I_{N_inverter}$:

$$M = k_T \times I_{n_inverter} \times \text{Setpoint}$$

04972AEN

Specification of a setpoint for the motor torque in rpm:

$$M = k_T \times 1.5 \times I_{n_inverter} \times \frac{\text{Setpoint}}{3000 \text{ rpm}}$$

04973AEN

- $I_{N_inverter}$ = Rated output current of the inverter
- k_T = Torque constant = M_n / I_{q_n}

M_n and I_{q_n} are motor-specific parameters. For the values of the torque constants k_T and the motor-specific parameters M_n and I_{q_n} , refer to the motor tables (DRS, DRE, DRP \rightarrow page 43, DRL \rightarrow page 32).

In addition to the current I_q for creating the torque, the inverter also needs to supply the magnetization current I_d . The actual inverter output current I_{tot} can be calculated using the following formulae:

Specification of a setpoint for the motor torque in % $I_{N_inverter}$:

$$I_{tot} = \sqrt{(\text{Setpoint} \times I_{n_inverter})^2 + I_{d_N}^2}$$

04974AEN

Specification of a setpoint for the motor torque in rpm:

$$I_{tot} = \sqrt{\left(\text{Setpoint} \times 1.5 \times I_{n_inverter} \times \frac{1}{3000 \text{ rpm}} \right)^2 + I_{d_N}^2}$$

04975AEN

- I_{q_n} = Rated value for the current, which generates the torque, according to the motor table
- I_{d_n} = Rated value for the magnetization current according to the motor table



Motor Selection

Motor selection for asynchronous servomotors (CFC)

Asynchronous DRL servomotors

SEW-EURODRIVE offers DRL series asynchronous servomotors especially for operation with MOVIDRIVE® in CFC operating modes. These motors have the following characteristics:

High power yield

The optimum winding of DRL motors permits a high power yield.

Classification into speed classes

DRL motors are available in four speed classes. The division into speed classes ensures optimum utilization of torque and speed.

With sin/cos encoder as standard

As standard, DRL motors are equipped with a high-resolution sin/cos encoder (ES7S, EG7S).

With TF or TH motor protection as standard

The winding temperature of the three motor phases is monitored using temperature sensors (TF). The thermistor can be connected to the TF/TH input of MOVIDRIVE®. The temperature is then monitored by MOVIDRIVE®; no additional monitoring unit is required.

Bimetallic switches (TH) can be used instead of thermistors. The bimetallic switches are also connected to the TF/TH input.

Thermal classification 155 (F) as standard

DRL motors are built using material of thermal classification 155 (F) as standard.

Dynamics packages 1 and 2

DRL motors are available in two dynamics packages. The motors differ in their overload capacity related to the motor torque.

- Dynamics 1: 190 % - 220 % motor overload capacity
- Dynamics 2: 300 % - 350 % motor overload capacity

DRS, DRE, DRP motors or DRL motors can be used in CFC mode. SEW-EURODRIVE recommends using DRL motors to achieve optimum benefit from the advantages of CFC mode.

	Advantage	Disadvantage
CFC mode with DRS, DRE, DRP motor selection → page 44	Standard motor version	Slower transition speed than the DRL motor.
		The power yield of the motor is less than the rated motor power.
		In terms of the power yield, the mass inertia is greater than that of the DRL motors.
		The maximum torque is limited for some of the inverter/motor combinations due to mechanical rigidity.
CFC mode with DRL motor Motor selection → page 35	Higher transition speed than DRS, DRE, DRP motors.	No IEC standard motor
	Usually with a power yield one motor type higher.	
	Based on the power yield of a lower mass moment of inertia.	Higher current demand due to higher power yield; therefore a larger inverter has to be assigned.
	Motor is designed for dynamic operation.	



DRL motor table

n _N rpm	Motor	M _N	I _N	I _{q,n}	I _{d,n}	k _T	M _{pk} Dyn1	M _{pk} Dyn2	J _{Mot}	J _{BMot}
		Nm (lb in)	A	A	A	Nm/A (lb in/A)	Nm (lb in)	Nm (lb in)	10 ⁻⁴ kgm ²	10 ⁻⁴ kgm ²
1200	DRL71S4	2.7 (24)	1.18	0.96	0.68	2.81 (24.9)	5 (44)	8.5 (75)	4.9	6.2
	DRL71M4	4 (35)	1.6	1.29	0.95	3.11 (27.5)	7 (62)	14 (124)	7.1	8.4
	DRL80M4	9.5 (84)	2.9	2.66	1.19	3.57 (31.6)	14 (124)	30 (266)	21.5	26
	DRL90L4	15 (133)	5.1	4.38	2.57	3.65 (32.3)	25 (221)	46 (407)	43.5	49.5
	DRL100L4	26 (230)	8.5	7.79	2.99	3.34 (29.6)	40 (354)	85 (752)	68	74
	DRL132S4	45 (398)	13.5	12.7	4.18	3.54 (31.3)	80 (708)	150 (1328)	190	200
	DRL132MC4	58 (513)	18.1	16.1	8.27	3.60 (31.9)	130 (1150)	200 (1770)	340	355
	DRL160M4	85 (752)	25.5	23.7	8.98	3.58 (31.7)	165 (1460)	280 (2478)	450	500
	DRL160MC4	95 (841)	29	27.1	11.8	3.51 (31.1)	185 (1637)	320 (2832)	590	640
	DRL180M4	140 (1239)	40	37.5	11.7	3.73 (33.0)	250 (2213)	430 (3806)	1110	1250
	DRL180L4	170 (1505)	48	45.3	15.6	3.75 (33.2)	320 (2832)	520 (4602)	1300	1440
	DRL180LC4	190 (1682)	56	52.5	17.8	3.62 (32)	420 (3717)	600 (5310)	1680	1910
	DRL225S4	270 (2390)	78	74.2	22.6	3.64 (32.2)	520 (4602)	770 (6815)	2930	3160
DRL225MC4	325 (2876)	98	89.4	38.7	3.64 (32.2)	770 (6815)	1100 (9736)	4330	4560	
1700	DRL71S4	2.7 (24)	1.63	1.33	0.94	2.03 (18.0)	5 (44)	8.5 (75)	4.9	6.2
	DRL71M4	4 (35)	2.20	1.79	1.31	2.24 (19.8)	7 (62)	14 (124)	7.1	8.4
	DRL80M4	9.5 (84)	4.00	3.66	1.64	2.59 (22.9)	14 (124)	30 (266)	21.5	26
	DRL90L4	15 (133)	6.90	5.81	3.51	2.67 (23.6)	25 (221)	46 (407)	43.5	49.5
	DRL100L4	26 (230)	11.4	10.7	4.09	2.44 (21.6)	40 (354)	85 (752)	68	74
	DRL132S4	45 (398)	18.5	18.0	5.90	2.50 (22.1)	80 (708)	150 (1328)	190	200
	DRL132MC4	58 (513)	25.0	22.8	11.7	2.54 (22.5)	130 (1150)	200 (1770)	340	355
	DRL160M4	85 (752)	35.0	32.8	12.4	2.59 (22.9)	165 (1460)	280 (2478)	450	500
	DRL160MC4	95 (841)	40.0	34.8	15.2	2.73 (24.2)	185 (1637)	320 (2832)	590	640
	DRL180M4	140 (1239)	55	52	16.3	2.69 (23.8)	250 (2213)	430 (3806)	1110	1250
	DRL180L4	170 (1505)	66	61.8	21.3	2.75 (24.3)	320 (2832)	520 (4602)	1300	1440
	DRL180LC4	185 (1637)	75	71.5	24.9	2.59 (22.9)	420 (3717)	600 (5310)	1680	1910
	DRL225S4	265 (2345)	105	100	31	2.65 (23.5)	520 (4602)	770 (6815)	2930	3160
DRL225MC4	315 (2788))	137	130	58.1	2.42 (21.4)	770 (6815)	1100 (9736)	4330	4560	
2100	DRL71S4	2.6 (23)	2.00	1.60	1.18	1.62 (14.3)	5 (44)	8.5 (75)	4.9	6.2
	DRL71M4	3.8 (33)	2.70	2.12	1.64	1.79 (15.8)	7 (62)	14 (124)	7.1	8.4
	DRL80M4	9.5 (84)	5.00	4.61	2.06	2.06 (18.2)	14 (124)	30 (266)	21.5	26
	DRL90L4	15 (133)	8.40	7.12	4.45	2.11 (18.7)	25 (221)	46 (407)	43.5	49.5
	DRL100L4	25 (221)	14.0	13.0	5.18	1.93 (17.1)	40 (354)	85 (752)	68	74
	DRL132S4	41 (363)	21.4	20.1	7.24	2.04 (18.1)	80 (708)	150 (1328)	190	200
	DRL132MC4	54 (478)	29.5	26.0	14.3	2.08 (18.4)	130 (1150)	200 (1770)	340	355
	DRL160M4	85 (752)	44.0	41.1	15.6	2.07 (18.3)	165 (1460)	280 (2478)	450	500
	DRL160MC4	93 (823)	49.0	45.9	20.5	2.02 (17.9)	185 (1637)	320 (2832)	590	640
	DRL180M4	135 (1195)	67.0	62.7	20.3	2.15 (19.0)	250 (2213)	430 (3806)	1110	1250
	DRL180L4	165 (1460)	80.0	76.2	27.1	2.17 (19.2)	320 (2832)	520 (4602)	1300	1440
	DRL180LC4	180 (1593)	92.0	86.1	30.9	2.09 (18.5)	420 (3717)	600 (5310)	1680	1910
	DRL225S4	250 (2213)	125	119	39.1	2.10 (18.6)	520 (4602)	770 (6815)	2930	3160
DRL225MC4	300 (2655)	157	143	67.1	2.10 (18.6)	770 (6815)	1100 (9736)	4330	4560	



Motor Selection

Motor selection for asynchronous servomotors (CFC)

n_N rpm	Motor	M_N Nm (lb in)	I_N A	I_{q_n} A	I_{d_n} A	k_T Nm/A (lb in/A)	M_{pk} Dyn1 Nm (lb in)	M_{pk} Dyn2 Nm (lb in)	J_{Mot} 10^{-4}	J_{BMot} kgm^2
3000	DRL71S4	2.5 (22)	2.68	2.13	1.63	1.17 (10.4)	5 (44)	8.5 (75)	4.9	6.2
	DRL71M4	3.6 (32)	3.55	2.79	2.28	1.29 (11.4)	7 (62)	14 (124)	7.1	8.4
	DRL80M4	8.8 (78)	6.50	5.87	2.84	1.50 (13.3)	14 (124)	30 (266)	21.5	26
	DRL90L4	14 (124)	11.1	9.09	6.08	1.54 (13.6)	25 (221)	46 (407)	43.5	49.5
	DRL100L4	21 (186)	16.6	14.9	7.09	1.41 (12.5)	40 (354)	85 (752)	68	74
	DRL132S4	35 (310)	25.5	24.2	10.2	1.45 (12.8)	80 (708)	150 (1328)	190	200
	DRL132MC4	45 (398)	36.0	30.7	20.3	1.47 (13)	130 (1150)	200 (1770)	340	355
	DRL160M4	79 (699)	57.0	52.8	21.5	1.50 (13.3)	165 (1460)	280 (2478)	450	500
	DRL160MC4	85 (752)	62.0	54.0	26.3	1.58 (14)	185 (1637)	320 (2832)	590	640
	DRL180M4	110 (974)	77.0	70.7	28.2	1.55 (13.7)	250 (2213)	430 (3806)	1110	1250
	DRL180L4	135 (1195)	93.0	85.0	36.9	1.59 (14.1)	320 (2832)	520 (4602)	1300	1440
	DRL180LC4	150 (1328)	107	100	43.2	1.49 (13.2)	420 (3717)	600 (5310)	1680	1910
	DRL225S4	210 (1859)	148	137	53.7	1.53 (13.5)	520 (4602)	770 (6815)	2930	3160
	DRL225MC4	250 (2213)	195	179	101	1.40 (12.4)	770 (6815)	1100 (9736)	4330	4560



Combination overview for DRL motors with MOVIDRIVE® B (mains voltage AC 400 V)

1. Rated speed $n_N = 1200$ rpm, dynamics package 1:

Assignment of MOVIDRIVE® MDX61B0005-5A3 ... MDX61B0040-503 (sizes 0 to 2):

Motor			MOVIDRIVE® MDX61B...-5_3 (AC 400/500 V units) in CFC operating modes (P700)										
			0005	0008	0011	0014	0015	0022	0030	0040	0055	0075	0110
DRL71S4	M_{max}	Nm (lb in)	5 (44)				5 (44)						
	n_{trans}	rpm	908				908						
DRL71M4	M_{max}	Nm (lb/in)	7 (62)				7 (62)						
	n_{trans}	rpm	931				925						
DRL80M4	M_{max}	Nm (lb in)	13.6 (120)	14 (124)	14 (124)		14 (124)						
	n_{trans}	rpm	960	1031	1066		1066						
DRL90L4	M_{max}	Nm (lb in)				25 (221)	19.8 (175)	25 (221)	25 (221)				
	n_{trans}	rpm				1019	1019	1037	1125				
DRL100L4	M_{max}	Nm (lb in)					25.7 (227)	33.6 (297)	40 (354)	40 (354)			
	n_{trans}	rpm					1154	1089	1101	1125			
DRL132S4	M_{max}	Nm (lb in)							48.2 (427)	64.6 (572)	80 (708)	80 (708)	
	n_{trans}	rpm							1093	1025	976	1010	
DRL132MC4	M_{max}	Nm (lb in)									81.1 (718)	126 (1115)	
	n_{trans}	rpm									1103	1005	
DRL160M4	M_{max}	Nm (lb in)										124 (1097)	
	n_{trans}	rpm										1067	
DRL160MC4	M_{max}	Nm (lb in)										119 (1053)	
	n_{trans}	rpm										1160	

Assignment of MOVIDRIVE® MDX61B0055-503 ... MDX61B0550-503 (sizes 3 ... 6):

Motor			MOVIDRIVE® MDX61B...-5_3 (AC 400/500 V units) in CFC operating modes (P700)										
			0150	0220	0300	0370	0450	0550	0750	0900	1100	1320	
DRL132MC4	M_{max}	Nm (lb in)	130 (1151)										
	n_{trans}	rpm	1108										
DRL160M4	M_{max}	Nm (lb in)	165 (1460)	165 (1460)									
	n_{trans}	rpm	1006	1076									
DRL160MC4	M_{max}	Nm (lb in)	163 (1443)	185 (1637)	185 (1637)								
	n_{trans}	rpm	1107	1234	1261								
DRL180M4	M_{max}	Nm (lb in)	173 (1531)	250 (2213)	250 (2213)								
	n_{trans}	rpm	1082	1002	1069								
DRL180L4	M_{max}	Nm (lb in)	170 (1505)	252 (2230)	320 (2832)	320 (2832)							
	n_{trans}	rpm	1102	1039	999	1059							
DRL180LC4	M_{max}	Nm (lb in)		241 (2133)	319 (2823)	391 (3461)	420 (3717)						
	n_{trans}	rpm		1082	1022	966	966						
DRL225S4	M_{max}	Nm (lb in)			317 (2806)	389 (3443)	478 (4231)	520 (4602)					
	n_{trans}	rpm			1148	1098	1037	1028					
DRL225MC4	M_{max}	Nm (lb in)					464 (4107)	555 (4912)	695 (6151)	770 (6815)			
	n_{trans}	rpm					1037	996	931	919			



Motor Selection

Motor selection for asynchronous servomotors (CFC)

2. Rated speed $n_N = 1200$ rpm, dynamics package 2:

Assignment of **MOVIDRIVE® MDX61B0005-5A3 ... MDX61B0040-503** (sizes 0 to 2S):

Motor		MOVIDRIVE® MDX61B...-5_3 (AC 400/500 V units) in CFC operating modes (P700)										
		0005	0008	0011	0014	0015	0022	0030	0040	0055	0075	
DRL71S4	M_{max}	Nm (lb in)	8.5 (75.2)				8.5 (75.2)					
	n_{trans}	rpm	515				515					
DRL71M4	M_{max}	Nm (lb/in)	12 (106)	14 (124)			14 (124)					
	n_{trans}	rpm	562	445			445					
DRL80M4	M_{max}	Nm (lb in)	13.6 (120)	16.6 (147)	21.7 (192)	28.2 (250)	21 (186)	29 (257)	30 (266)			
	n_{trans}	rpm	960	884	744	568	761	544	527			
DRL90L4	M_{max}	Nm (lb in)				27.6 (244)	19.8 (175)	28.6 (253)	37.1 (328)	46 (407)		
	n_{trans}	rpm				925	1019	914	808	697		
DRL100L4	M_{max}	Nm (lb in)						25.7 (227)	33.6 (297)	46.5 (412)	61.8 (547)	79.3 (702)
	n_{trans}	rpm						1154	1089	972	826	668
DRL132S4	M_{max}	Nm (lb in)								48.2 (427)	64.6 (572)	83.5 (739)
	n_{trans}	rpm								1093	1025	942
DRL132MC4	M_{max}	Nm (lb in)										81.1 (718)
	n_{trans}	rpm										1103

Assignment of **MOVIDRIVE® MDX61B0055-503 ... MDX61B0550-503** (sizes 2 ... 6):

Motor		MOVIDRIVE® MDX61B...-5_3 (AC 400/500 V units) in CFC operating modes (P700)										
		0110	0150	0220	0300	0370	0450	0550	0750	0900	1100	1320
DRL132S4	M_{max}	Nm (lb in)	126 (1115)	150 (1328)								
	n_{trans}	rpm	752	654								
DRL132MC4	M_{max}	Nm (lb in)	126 (1115)	170 (1505)	200 (1770)							
	n_{trans}	rpm	1005	903	844							
DRL160M4	M_{max}	Nm (lb in)	124 (1097)	168 (1487)	244 (2160)	280 (2478)						
	n_{trans}	rpm	1067	984	839	773						
DRL160MC4	M_{max}	Nm (lb in)	119 (1053)	163 (1443)	238 (2106)	312 (2761)	320 (2832)					
	n_{trans}	rpm	1160	1107	1006	905	905					
DRL180M4	M_{max}	Nm (lb in)		173 (1531)	253 (2239)	332 (2938)	405 (3585)	430 (3806)				
	n_{trans}	rpm		1082	992	896	810	780				
DRL180L4	M_{max}	Nm (lb in)		170 (1505)	252 (2230)	332 (2850)	406 (3593)	497 (4399)	520 (4602)			
	n_{trans}	rpm		1102	1039	966	899	816	793			
DRL180LC4	M_{max}	Nm (lb in)			241 (2133)	319 (2823)	391 (3461)	479 (4240)	566 (5010)	600 (5310)		
	n_{trans}	rpm			1082	1022	966	893	820	793		
DRL225S4	M_{max}	Nm (lb in)				317 (2806)	389 (3443)	478 (4231)	567 (5018)	703 (6222)	770 (6815)	770 (6815)
	n_{trans}	rpm				1148	1098	1037	972	873	829	758
DRL225MC4	M_{max}	Nm (lb in)				317 (2806)	389 (3443)	478 (4231)	567 (5018)	703 (6222)	770 (6815)	1079 (9550)
	n_{trans}	rpm				1148	1098	1037	972	873	829	758



3. Rated speed $n_N = 1700$ rpm, dynamics package 1:

Assignment of **MOVIDRIVE® MDX61B0005-5A3 ... MDX61B0040-503** (sizes 0 to 2):

Motor		MOVIDRIVE® MDX61B...-5_3 (AC 400/500 V units) in CFC operating modes (P700)											
		0005	0008	0011	0014	0015	0022	0030	0040	0055	0075	0110	
DRL71S4	M_{max}	Nm (lb in)	5 (44)			5 (44)							
	n_{trans}	rpm	1470			1470							
DRL71M4	M_{max}	Nm (lb/in)	7 (62)	7 (62)		7 (62)							
	n_{trans}	rpm	1459	1488		1488							
DRL80M4	M_{max}	Nm (lb in)			14 (124)	14 (124)	14 (124)	14 (124)					
	n_{trans}	rpm			1523	1681	1494	1687					
DRL90L4	M_{max}	Nm (lb in)						19.9 (176)	25 (221)	25 (221)			
	n_{trans}	rpm						1464	1459	1705			
DRL100L4	M_{max}	Nm (lb in)							23.6 (209)	33.3 (295)	40 (354)	40 (354)	
	n_{trans}	rpm							1658	1564	1587	1669	
DRL132S4	M_{max}	Nm (lb in)									44.6 (395)	58.2 (515)	80 (708)
	n_{trans}	rpm									1606	1543	1494
DRL132MC4	M_{max}	Nm (lb in)											86.5 (766)
	n_{trans}	rpm											1586
DRL160M4	M_{max}	Nm (lb in)											87.8 (777)
	n_{trans}	rpm											1590

Assignment of **MOVIDRIVE® MDX61B0055-503 ... MDX61B0550-503** (sizes 3 ... 6):

Motor		MOVIDRIVE® MDX61B...-5_3 (AC 400/500 V units) in CFC operating modes (P700)											
		0150	0220	0300	0370	0450	0550	0750	0900	1100	1320		
DRL132S4	M_{max}	Nm (lb in)	80 (708)										
	n_{trans}	rpm	1518										
DRL132MC4	M_{max}	Nm (lb in)	118 (1044)	130 (1151)									
	n_{trans}	rpm	1503	1655									
DRL160M4	M_{max}	Nm (lb in)	120 (1062)	165 (1460)									
	n_{trans}	rpm	1524	1560									
DRL160MC4	M_{max}	Nm (lb in)	124 (1097)	183 (1620)	185 (1637)	185 (1637)							
	n_{trans}	rpm	1507	1423	1648	1674							
DRL180M4	M_{max}	Nm (lb in)		180 (1593)	238 (2106)	250 (2213)	250 (2213)						
	n_{trans}	rpm		1517	1434	1520	1534						
DRL180L4	M_{max}	Nm (lb in)		180 (1593)	240 (2124)	295 (2611)	320 (2832)	320 (2832)					
	n_{trans}	rpm		1517	1457	1401	1457	1500					
DRL180LC4	M_{max}	Nm (lb in)			223 (1974)	275 (2434)	339 (3000)	402 (3558)	420 (3717)				
	n_{trans}	rpm			1557	1507	1444	1377	1397				
DRL225S4	M_{max}	Nm (lb in)				277 (2452)	343 (3036)	408 (3611)	509 (4505)	520 (4602)			
	n_{trans}	rpm				1631	1576	1517	1420	1444			
DRL225MC4	M_{max}	Nm (lb in)							451 (3992)	602 (5328)	713 (6311)	770 (6815)	
	n_{trans}	rpm							1585	1494	1420	1420	



Motor Selection

Motor selection for asynchronous servomotors (CFC)

4. Rated speed $n_N = 1700$ rpm, dynamics package 2:

Assignment of **MOVIDRIVE® MDX61B0005-5A3 ... MDX61B0040-503** (sizes 0 to 2):

Motor			MOVIDRIVE® MDX61B...-5_3 (AC 400/500 V units) in CFC operating modes (P700)											
			0005	0008	0011	0014	0015	0022	0030	0040	0055	0075	0110	
DRL71S4	M_{max}	Nm (lb in)	7.9 (70)	8.5 (75)			8.5 (75)							
	n_{trans}	rpm	1025	955			955							
DRL71M4	M_{max}	Nm (lb/in)	8.4 (74)	10.3 (91.2)	13.5 (119)	14 (124)	13 (115)	14 (124)						
	n_{trans}	rpm	1242	1107	884	849	914	849						
DRL80M4	M_{max}	Nm (lb in)			15.5 (137)	20.3 (180)	15 (133)	21 (186)	26.9 (238)	30 (266)				
	n_{trans}	rpm			1382	1242	1400	1224	1048	955				
DRL90L4	M_{max}	Nm (lb in)						19.9 (176)	26.4 (234)	36.9 (327)	46 (407)			
	n_{trans}	rpm						1464	1382	1236	1125			
DRL100L4	M_{max}	Nm (lb in)							23.6 (209)	33.3 (295)	44.6 (395)	57.7 (511)	85 (752)	
	n_{trans}	rpm							1658	1564	1447	1306	1013	
DRL132S4	M_{max}	Nm (lb in)									44.6 (395)	58.2 (515)	88.9 (787)	
	n_{trans}	rpm									1606	1543	1372	
DRL132MC4	M_{max}	Nm (lb in)												86.5 (766)
	n_{trans}	rpm												1586
DRL160M4	M_{max}	Nm (lb in)												87.8 (777)
	n_{trans}	rpm												1590

Assignment of **MOVIDRIVE® MDX61B0055-503 ... MDX61B0550-503** (sizes 3 ... 6):

Motor			MOVIDRIVE® MDX61B...-5_3 (AC 400/500 V units) in CFC operating modes (P700)											
			0150	0220	0300	0370	0450	0550	0750	0900	1100	1320		
DRL132S4	M_{max}	Nm (lb in)	119 (1053)	150 (1328)										
	n_{trans}	rpm	1206	1040										
DRL132MC4	M_{max}	Nm (lb in)	118 (1044)	172 (1522)	200 (1770)									
	n_{trans}	rpm	1503	1347	1279									
DRL160M4	M_{max}	Nm (lb in)	120 (1062)	176 (1558)	231 (2045)	280 (2478)								
	n_{trans}	rpm	1524	1397	1261	1147								
DRL160MC4	M_{max}	Nm (lb in)	124 (1097)	183 (1620)	242 (2142)	295 (2611)	320 (2832)							
	n_{trans}	rpm	1507	1423	1327	1239	1212							
DRL180M4	M_{max}	Nm (lb in)		180 (1593)	238 (2106)	291 (2576)	356 (3151)	421 (3726)	430 (3806)					
	n_{trans}	rpm		1517	1434	1354	1255	1155	1142					
DRL180L4	M_{max}	Nm (lb in)		180 (1593)	240 (2124)	295 (2611)	362 (3204)	429 (3797)	520 (4602)					
	n_{trans}	rpm		1517	1457	1401	1324	1245	1138					
DRL180LC4	M_{max}	Nm (lb in)			223 (1974)	275 (2434)	339 (3000)	402 (3558)	499 (4417)	600 (5310)				
	n_{trans}	rpm			1557	1507	1444	1377	1271	1165				
DRL225S4	M_{max}	Nm (lb in)				277 (2452)	343 (3036)	408 (3611)	509 (4505)	668 (5912)	770 (6815)			
	n_{trans}	rpm				1631	1576	1517	1420	1268	1177			
DRL225MC4	M_{max}	Nm (lb in)							451 (3992)	602 (5328)	713 (6311)	896 (7930)		
	n_{trans}	rpm							1585	1494	1420	1300		



5. Rated speed $n_N = 2100$ rpm, dynamics package 1:

Assignment of **MOVIDRIVE® MDX61B0005-5A3 ... MDX61B0040-503** (sizes 0 to 2):

Motor		MOVIDRIVE® MDX61B...-5_3 (AC 400/500 V units) in CFC operating modes (P700)											
		0005	0008	0011	0014	0015	0022	0030	0040	0055	0075	0110	
DRL71S4	M_{max}	Nm (lb in)	5 (44)	5 (44)			5 (44)						
	n_{trans}	rpm	1980	1986			1986						
DRL71M4	M_{max}	Nm (lb/in)	7 (62)	7 (62)			7 (62)						
	n_{trans}	rpm	1904	1986			1986						
DRL80M4	M_{max}	Nm (lb in)				14 (124)	11.6 (103)	14 (124)	14 (124)				
	n_{trans}	rpm				2044	1951	2085	2273				
DRL90L4	M_{max}	Nm (lb in)							20 (177)	25 (221)	25 (221)		
	n_{trans}	rpm							1910	2027	2302		
DRL100L4	M_{max}	Nm (lb in)								25.6 (227)	34.7 (307)	40 (354)	40 (354)
	n_{trans}	rpm								2121	2021	2103	2238
DRL132S4	M_{max}	Nm (lb in)										46.7 (413)	72 (637)
	n_{trans}	rpm										1987	1835

Assignment of **MOVIDRIVE® MDX61B0055-503 ... MDX61B0550-503** (sizes 3 ... 6):

Motor		MOVIDRIVE® MDX61B...-5_3 (AC 400/500 V units) in CFC operating modes (P700)										
		0150	0220	0300	0370	0450	0550	0750	0900	1100	1320	
DRL132S4	M_{max}	Nm (lb in)	80 (708)									
	n_{trans}	rpm	1909									
DRL132MC4	M_{max}	Nm (lb in)	95.3 (843)	130 (1151)	130 (1151)							
	n_{trans}	rpm	1933	1923	2070							
DRL160M4	M_{max}	Nm (lb in)	93 (823)	139 (1230)	165 (1460)	165 (1460)						
	n_{trans}	rpm	2003	1889	1929	2008						
DRL160MC4	M_{max}	Nm (lb in)		133 (1177)	177 (1567)	185 (1637)	185 (1637)					
	n_{trans}	rpm		2043	1964	2175	2320					
DRL180M4	M_{max}	Nm (lb in)		142 (1257)	188 (1664)	231 (2045)	250 (2213)	250 (1952)				
	n_{trans}	rpm		1975	1905	1832	1915	1952				
DRL180L4	M_{max}	Nm (lb in)			186 (1646)	229 (2027)	283 (2505)	320 (2832)	320 (2832)			
	n_{trans}	rpm			1939	1885	1819	1819	1945			
DRL180LC4	M_{max}	Nm (lb in)				219 (1938)	271 (2399)	323 (2859)	402 (3558)	420 (3717)		
	n_{trans}	rpm				1945	1889	1826	1726	1796		
DRL225S4	M_{max}	Nm (lb in)					268 (2372)	320 (2832)	401 (3549)	520 (4602)	520 (4602)	
	n_{trans}	rpm					2077	2024	1936	1810	1842	
DRL225MC4	M_{max}	Nm (lb in)								516 (4567)	814 (7205)	770 (6815)
	n_{trans}	rpm								1793	1722	1611



Motor Selection

Motor selection for asynchronous servomotors (CFC)

6. Rated speed $n_N = 2100$ rpm, dynamics package 2:

Assignment of **MOVIDRIVE® MDX61B0005-5A3 ... MDX61B0040-503** (sizes 0 to 2):

Motor			MOVIDRIVE® MDX61B...-5_3 (AC 400/500 V units) in CFC operating modes (P700)										
			0005	0008	0011	0014	0015	0022	0030	0040	0055	0075	0110
DRL71S4	M_{max}	Nm (lb in)	6.2 (55)	7.5 (66)	8.5 (75)		8.5 (75)						
	n_{trans}	rpm	1652	1476	1347		1347						
DRL71M4	M_{max}	Nm (lb/in)		8.1 (72)	10.7 (95)	14 (124)	10.3 (91)	14 (91)					
	n_{trans}	rpm		1675	1470	1212	1500	1207					
DRL80M4	M_{max}	Nm (lb in)				15.9 (141)	11.6 (103)	16.5 (146)	21.2 (188)	29.1 (258)	30 (266)		
	n_{trans}	rpm				1816	1951	1798	1640	1382	1353		
DRL90L4	M_{max}	Nm (lb in)							20 (177)	28.5 (252)	38.4 (340)	46 (407)	
	n_{trans}	rpm							1910	1787	1634	1546	
DRL100L4	M_{max}	Nm (lb in)								25.6 (227)	34.7 (307)	45.2 (400)	68.6 (607)
	n_{trans}	rpm								2121	2021	1892	1599
DRL132S4	M_{max}	Nm (lb in)										46.7 (413)	72 (637)
	n_{trans}	rpm										1987	1835

Assignment of **MOVIDRIVE® MDX61B0055-503 ... MDX61B0550-503** (sizes 3 ... 6):

Motor			MOVIDRIVE® MDX61B...-5_3 (AC 400/500 V units) in CFC operating modes (P700)										
			0150	0220	0300	0370	0450	0550	0750	0900	1100	1320	
DRL100L4	M_{max}	Nm (lb in)	85 (752)										
	n_{trans}	rpm	1394										
DRL132S4	M_{max}	Nm (lb in)	96.9 (858)	139 (1230)	150 (1328)								
	n_{trans}	rpm	1674	1396	1337								
DRL132MC4	M_{max}	Nm (lb in)	95.3 (843)	140 (1239)	184 (1629)	200 (1770)							
	n_{trans}	rpm	1933	1796	1645	1606							
DRL160M4	M_{max}	Nm (lb in)	93 (823)	139 (1230)	183 (1620)	224 (1983)	273 (2416)	280 (2478)					
	n_{trans}	rpm	2003	1889	1766	1652	1507	1489					
DRL160MC4	M_{max}	Nm (lb in)		133 (1177)	177 (1567)	217 (1921)	267 (2363)	316 (2797)	320 (2832)				
	n_{trans}	rpm		2043	1964	1889	1788	1683	1700				
DRL180M4	M_{max}	Nm (lb in)		142 (1257)	188 (1664)	231 (2045)	284 (2514)	336 (2974)	417 (3691)	430 (3806)			
	n_{trans}	rpm		1975	1905	1832	1739	1640	1490	1467			
DRL180L4	M_{max}	Nm (lb in)			186 (1646)	229 (2027)	283 (2505)	336 (2974)	418 (3700)	520 (4602)			
	n_{trans}	rpm			1939	1885	1819	1749	1633	1490			
DRL180LC4	M_{max}	Nm (lb in)				219 (1938)	271 (2399)	323 (2859)	402 (3558)	529 (4682)	600 (5310)		
	n_{trans}	rpm				1945	1889	1826	1726	1560	1470		
DRL225S4	M_{max}	Nm (lb in)					268 (2372)	320 (2832)	401 (3549)	529 (4682)	624 (5523)	770 (6815)	
	n_{trans}	rpm					2077	2024	1936	1787	1675	1508	
DRL225MC4	M_{max}	Nm (lb in)								516 (4567)	614 (5434)	774 (6850)	
	n_{trans}	rpm								1793	1722	1605	



7. Rated speed $n_N = 3000$ rpm, dynamics package 1:

Assignment of **MOVIDRIVE® MDX61B0005-5A3 ... MDX61B0040-503 (sizes 0 to 2):**

Motor		MOVIDRIVE® MDX61B...-5_3 (AC 400/500 V units) in CFC operating modes (P700)										
		0005	0008	0011	0014	0015	0022	0030	0040	0055	0075	0110
DRL71S4	M_{max} Nm (lb in)		5 (44)	5 (44)		5 (44)						
	n_{trans} rpm		2742	2947		2947						
DRL71M4	M_{max} Nm (lb/in)			7 (62)	7 (62)	7 (62)	7 (62)					
	n_{trans} rpm			2683	3000	2619	3000					
DRL80M4	M_{max} Nm (lb in)						11.6 (103)	14 (124)	14 (124)			
	n_{trans} rpm						2789	2865	3369			
DRL90L4	M_{max} Nm (lb in)								19.9 (176)	25 (221)	25 (221)	25 (221)
	n_{trans} rpm								2683	2794	3269	3369
DRL100L4	M_{max} Nm (lb in)									24.4 (216)	32.3 (286)	40 (354)
	n_{trans} rpm									2970	2871	3123
DRL132S4	M_{max} Nm (lb in)											49.9 (442)
	n_{trans} rpm											2827

Assignment of **MOVIDRIVE® MDX61B0055-503 ... MDX61B0550-503 (sizes 3 ... 6):**

Motor		MOVIDRIVE® MDX61B...-5_3 (AC 400/500 V units) in CFC operating modes (P700)										
		0150	0220	0300	0370	0450	0550	0750	0900	1100	1320	
DRL100L4	M_{max} Nm (lb in)	40 (354)										
	n_{trans} rpm	3210										
DRL132S4	M_{max} Nm (lb in)	67.8 (600)	80 (708)									
	n_{trans} rpm	2690	2822									
DRL132MC4	M_{max} Nm (lb in)		96.8 (857)	128 (1133)	130 (1151)	130 (1151)						
	n_{trans} rpm		2783	2656	2959	3017						
DRL160M4	M_{max} Nm (lb in)		98.2 (869)	131 (1159)	160 (1416)	165 (1460)	165 (1460)					
	n_{trans} rpm		2786	2685	2579	2803	2843					
DRL160MC4	M_{max} Nm (lb in)			135 (1195)	167 (1478)	185 (1637)	185 (1637)	185 (1637)				
	n_{trans} rpm			2649	2584	2751	2992	3036				
DRL180M4	M_{max} Nm (lb in)				164 (1452)	202 (178)	241 (2133)	250 (2213)				
	n_{trans} rpm				2719	2639	2553	2752				
DRL180L4	M_{max} Nm (lb in)					203 (1797)	243 (2151)	304 (2691)	320 (2832)			
	n_{trans} rpm					2639	2583	2480	2709			
DRL180LC4	M_{max} Nm (lb in)						226 (2000)	284 (2514)	375 (3319)	420 (3717)	420 (3717)	
	n_{trans} rpm						2735	2652	2503	2483	2563	
DRL225S4	M_{max} Nm (lb in)							286 (2531)	380 (3363)	451 (3992)	520 (4602)	
	n_{trans} rpm							2847	2715	2610	2563	
DRL225MC4	M_{max} Nm (lb in)											505 (4470)
	n_{trans} rpm											2727



Motor Selection

Motor selection for asynchronous servomotors (CFC)

8. Rated speed $n_N = 3000$ rpm, dynamics package 2:

Assignment of MOVIDRIVE® MDX61B0005-5A3 ... MDX61B0040-503 (sizes 0 to 2):

Motor			MOVIDRIVE® MDX61B...-5_3 (AC 400/500 V units) in CFC operating modes (P700)										
			0005	0008	0011	0014	0015	0022	0030	0040	0055	0075	0110
DRL71S4	M_{max}	Nm (lb in)	5.3 (47)	7 (62)	8.5 (75)	6.8 (60)	8.5 (75)						
	n_{trans}	rpm	2601	2326	2085	2367	2085						
DRL71M4	M_{max}	Nm (lb/in)		7.4 (65)	9.9 (88)	7.2 (64)	10.2 (90)	13.2 (117)	14 (124)				
	n_{trans}	rpm		2525	2296	2554	2261	1980	1904				
DRL80M4	M_{max}	Nm (lb in)					11.6 (103)	15.1 (134)	20.9 (185)	27.7 (245)	30 (266)		
	n_{trans}	rpm					2789	2660	2443	2179	2109		
DRL90L4	M_{max}	Nm (lb in)							19.9 (176)	27.3 (242)	35.8 (317)	46 (407)	
	n_{trans}	rpm							2683	2560	2414	2332	
DRL100L4	M_{max}	Nm (lb in)								24.4 (216)	32.3 (286)	49.7 (440)	
	n_{trans}	rpm								2970	2871	2625	
DRL132S4	M_{max}	Nm (lb in)										49.9 (442)	
	n_{trans}	rpm										2827	

Assignment of MOVIDRIVE® MDX61B0055-503 ... MDX61B0550-503 (sizes 3 ... 6):

Motor			MOVIDRIVE® MDX61B...-5_3 (AC 400/500 V units) in CFC operating modes (P700)										
			0150	0220	0300	0370	0450	0550	0750	0900	1100	1320	
DRL100L4	M_{max}	Nm (lb in)	66.8 (591)	85 (752)									
	n_{trans}	rpm	2355	2074									
DRL132S4	M_{max}	Nm (lb in)	67.8 (600)	98.7 (874)	129 (1142)	150 (1328)							
	n_{trans}	rpm	2690	2431	2168	1997							
DRL132MC4	M_{max}	Nm (lb in)		96.8 (857)	128 (1133)	158 (1398)	193 (1708)	200 (1770)	200 (1770)				
	n_{trans}	rpm		2783	2656	2529	2368	2363	2412				
DRL160M4	M_{max}	Nm (lb in)		98.2 (869)	131 (1159)	160 (1416)	197 (1744)	233 (2062)	280 (2478)				
	n_{trans}	rpm		2786	2685	2579	2447	2307	2135				
DRL160MC4	M_{max}	Nm (lb in)			135 (1195)	167 (1478)	206 (1823)	244 (2160)	304 (2691)	320 (2832)			
	n_{trans}	rpm			2649	2584	2496	2399	2245	2280			
DRL180M4	M_{max}	Nm (lb in)				164 (1452)	202 (1788)	241 (2133)	300 (2655)	393 (3478)	430 (3806)		
	n_{trans}	rpm				2719	2639	2553	2413	2181	2095		
DRL180L4	M_{max}	Nm (lb in)					203 (1797)	243 (2151)	304 (2691)	401 (3549)	473 (4186)	520 (4602)	
	n_{trans}	rpm					2639	2583	2480	2307	2174	2088	
DRL180LC4	M_{max}	Nm (lb in)						226 (2000)	284 (2514)	375 (3319)	443 (3921)	556 (4921)	
	n_{trans}	rpm						2735	2652	2503	2384	2184	
DRL225S4	M_{max}	Nm (lb in)							286 (2531)	380 (3363)	451 (3992)	567 (5018)	
	n_{trans}	rpm							2847	2715	2610	2425	
DRL225MC4	M_{max}	Nm (lb in)										505 (4470)	
	n_{trans}	rpm										2727	



Motor table DRS AC motors (characteristic value with delta/star connection AC 230/400 V / 50 Hz)

Motor	M _N Nm (lb in)	Mass moment of inertia J _M		Star \star (AC 400 V)				Delta Δ (AC 230 V)			
		Without brake	With brake	I _n	I _{q_n} ¹⁾	I _{d_n} ¹⁾	k _T ¹⁾	I _n	I _{q_n} ¹⁾	I _{d_n} ¹⁾	k _T ¹⁾
		10 ⁻⁴ kgm ²		A	A	A	Nm/A (lb in/A)	A	A	A	Nm/A (lb in/A)
DRS71S4	2.55 (22.6)	4.9	6.2	1.14	0.91	0.68	2.79 (24.7)	1.97	1.58	1.18	1.61 (14.2)
DRS71M4	3.8 (34)	7.1	8.4	1.55	1.23	0.95	3.10 (27.4)	2.68	2.12	1.64	1.79 (15.8)
DRS80S4	5.1 (45)	14.9	16.4	1.8	1.54	0.93	3.31 (29.3)	3.1	2.67	1.61	1.91 (16.9)
DRS80M4	7.4 (65)	21.5	26	2.4	2.09	1.19	3.55 (31.4)	4.2	3.6	2.1	2.05 (18.1)
DRS90M4	10.3 (91.2)	35.5	40	3.3	3.0	1.39	3.44 (30.4)	5.7	5.2	2.4	1.99 (17.6)
DRS90L4	15 (133)	43.5	49.5	4.85	4.11	2.57	3.65 (32.3)	8.4	7.1	4.4	2.10 (18.6)
DRS100M4	20.5 (181)	56	62	6.4	5.91	2.45	3.47 (30.7)	11.1	10.2	4.2	2.00 (17.7)
DRS100LC4	26.5 (235)	90	96	8.4	7.55	3.67	3.51 (31.1)	14.5	13.1	6.4	2.03 (18.0)
DRS112M4	26.5 (235)	146	151	8.1	7.71	2.49	3.44 (30.4)	14.0	13.4	4.3	1.98 (17.5)
DRS132S4	36.5 (323)	190	200	11.1	10.3	4.18	3.55 (31.4)	19.2	17.8	7.2	2.05 (18.1)
DRS132M4	49.5 (438)	255	265	14.4	13.6	4.64	3.63 (32.1)	24.9	23.6	8.0	2.10 (18.6)
DRS132MC4	60 (531)	340	355	18.6	16.6	8.29	3.60 (31.9)	32.2	28.8	14.4	2.08 (18.4)
DRS160S4	60 (531)	370	420	18.9	16.8	8.75	3.58 (31.7)	32.7	29.1	15.2	2.07 (18.3)
DRS160M4	72 (640)	450	500	22	20.1	8.94	3.58 (31.7)	38.1	34.8	15.5	2.07 (18.3)
DRS160MC4	94 (832)	590	640	30	27.8	11.8	3.38 (29.9)	52.0	48.1	20.5	1.95 (17.3)
DRS180S4	98 (870)	900	960	29	26.4	11.7	3.71 (32.8)	50.2	45.7	20.3	2.14 (18.9)
DRS180M4	121 (1070)	1110	1250	34.5	32.0	12.7	3.78 (33.5)	59.8	55.4	21.9	2.18 (19.3)
DRS180L4	143 (1266)	1300	1440	41.5	37.5	17.3	3.81 (33.7)	71.9	64.9	29.9	2.20 (19.5)
DRS180LC4	195 (1730)	1680	1910	57	52.6	21.2	3.71 (32.8)	98.7	91.1	36.7	2.14 (18.9)
DRS200L4	194 (1720)	2360	2590	57	53.2	20.6	3.64 (32.2)	98.7	92.2	35.7	2.10 (18.6)
DRS225S4	240 (2120)	2930	3160	70	64.8	25.2	3.70 (32.7)	121	112	43.7	2.14 (18.9)
DRS225M4	290 (2570)	3430	3660	84	76.2	35.1	3.80 (33.6)	145	132	60.8	2.20 (19.5)
DRS225MC4	355 (3140)	4330	4560	105	97.6	38.7	3.64 (32.2)	182	169	67.1	2.10 (18.6)
DRS315K4	710 (6284)	18400	19500	200	185	75.9	3.84 (34.0)	345	321	131	2.22 (19.6)
DRS315S4	850 (7520)	22500	23600	245	212	94.7	4.01 (35.5)	425	367	164	2.32 (20.5)
DRS315M4	1030 (9116)	27900	29000	280	262	97.4	3.92 (34.7)	485	455	169	2.27 (20.1)

1) Applies in the basic speed range up to n_{trans}.



Motor Selection

Motor selection for asynchronous servomotors (CFC)

DRS motor selection with delta/star connection type (AC 230/400 V / 50 Hz)

1. Motors AC 230/400 V / 50 Hz in Δ connection or motors AC 400/690 V / 50 Hz in Δ connection

Assignment of MOVIDRIVE® MDX61B0005-5A3 ... MDX61B0110-503 (sizes 0 ... 2):

Motor		MOVIDRIVE® MDX61B...-5_3 (AC 400/500 V units) in CFC operating modes (P700)										
Δ AC 400 V / 50 Hz		0005	0008	0011	0014	0015	0022	0030	0040	0055	0075	0110
DRS71S4	M _{max}	Nm (lb in)	10 (88.5)			10 (88.5)						
	n _{trans}	rpm	375			375						
DRS71M4	M _{max}	Nm (lb in)	10 (88.5)			10 (88.5)						
	n _{trans}	rpm	685			685						
DRS80S4	M _{max}	Nm (lb in)	12.9 (114)	14 (124)		14 (124)						
	n _{trans}	rpm	761	703		704						
DRS80M4	M _{max}	Nm (lb in)	13.6 (120)	14 (124)	14 (124)	14 (124)						
	n _{trans}	rpm	960	1031	1066	1066						
DRS90M4	M _{max}	Nm (lb in)			20.7 (183)	27 (239)	20 (177)	27.9 (247)	28 (248)			
	n _{trans}	rpm			925	791	943	774	767			
DRS90L4	M _{max}	Nm (lb in)				27.6 (244)	19.8 (175)	28.6 (253)	37.1 (328)	40 (354)		
	n _{trans}	rpm				925	1019	914	808	785		
DRS100M4	M _{max}	Nm (lb in)						27.3 (242)	35.3 (312)	40 (354)		
	n _{trans}	rpm						1113	1037	1066		
DRS100LC4	M _{max}	Nm (lb in)						34.4 (304)	48.2 (427)	55 (487)	55 (487)	
	n _{trans}	rpm						1166	1095	1148	1212	
DRS112M4	M _{max}	Nm (lb in)						35.2 (312)	48.4 (428)	55 (487)		
	n _{trans}	rpm						1152	1059	1040		
DRS132S4	M _{max}	Nm (lb in)							48.2 (427)	64.6 (572)	83.5 (739)	110 (974)
	n _{trans}	rpm							1093	1025	942	825
DRS132M4	M _{max}	Nm (lb in)								66.1 (585)	85.6 (758)	110 (974)
	n _{trans}	rpm								1079	1015	976
DRS132MC4	M _{max}	Nm (lb in)									81.1 (718)	126 (1115)
	n _{trans}	rpm									1103	1005
DRS160S4	M _{max}	Nm (lb in)									80.2 (710)	125 (1106)
	n _{trans}	rpm									1063	980
DRS160M4	M _{max}	Nm (lb in)										124 (1097)
	n _{trans}	rpm										1067
DRS160MC4	M _{max}	Nm (lb in)										119 (1050)
	n _{trans}	rpm										1160
DRS180S4	M _{max}	Nm (lb in)										126 (1100)
	n _{trans}	rpm										1092

Note:

The data is based on a supply voltage of AC 400 V.



Assignment of MOVIDRIVE® MDX61B0150-503 ... MDX61B1320-503 (sizes 3 ... 6):

Motor		MOVIDRIVE® MDX61B...-5_3 (AC 400/500 V units) in CFC operating modes (P700)									
AC 400 V / 50 Hz		0150	0220	0300	0370	0450	0550	0750	0900	1100	1320
DRS132MC4	M _{max}	Nm (lb in)	170 (1505)	200 (1770)							
	n _{trans}	rpm	903	844							
DRS160S4	M _{max}	Nm (lb in)	169 (1496)	200 (1770)							
	n _{trans}	rpm	892	852							
DRS160M4	M _{max}	Nm (lb in)	168 (1487)	200 (1770)							
	n _{trans}	rpm	984	958							
DRS160MC4	M _{max}	Nm (lb in)	163 (1443)	200 (1770)	200 (1770)						
	n _{trans}	rpm	1107	1164	1204						
DRS180S4	M _{max}	Nm (lb in)	172 (1522)	200 (1770)							
	n _{trans}	rpm	1029	1079							
DRS180M4	M _{max}	Nm (lb in)	174 (1540)	255 (2257)	335 (2965)	400 (3540)					
	n _{trans}	rpm	1069	979	886	810					
DRS180L4	M _{max}	Nm (lb in)	171 (1513)	255 (2257)	337 (2983)	400 (3540)					
	n _{trans}	rpm	1085	1022	952	909					
DRS180LC4	M _{max}	Nm (lb in)		243 (2151)	324 (2868)	397 (3514)	488 (4319)	578 (5116)	600 (5310)		
	n _{trans}	rpm		1065	1009	949	879	810	793		
DRS200L4	M _{max}	Nm (lb in)		241 (2133)	320 (2832)	393 (3478)	482 (4266)	570 (5045)	600 (5310)		
	n _{trans}	rpm		1081	1022	963	890	820	796		
DRS225S4	M _{max}	Nm (lb in)			319 (2823)	393 (3478)	484 (4284)	574 (5080)	600 (5310)		
	n _{trans}	rpm			1110	1066	1010	962	934		
DRS225M4	M _{max}	Nm (lb in)				394 (3487)	490 (4337)	584 (5169)	600 (5310)		
	n _{trans}	rpm				1092	1054	1013	1092		
DRS225MC4	M _{max}	Nm (lb in)				464 (4107)	555 (4912)	695 (6151)	914 (8090)	1079 (9550)	1200 (10621)
	n _{trans}	rpm				1037	996	931	832	758	709
DRS315K4	M _{max}	Nm (lb in)							932 (8249)	1111 (9833)	1406 (12444)
	n _{trans}	rpm							1053	1041	1015
DRS315S4	M _{max}	Nm (lb in)								1141 (10099)	1455 (12878)
	n _{trans}	rpm								1074	1056
DRS315M4	M _{max}	Nm (lb in)									1421 (12577)
	n _{trans}	rpm									1010

Note:
The data is based on a supply voltage of AC 400 V.



Motor Selection

Motor selection for asynchronous servomotors (CFC)

2. Motors AC 230/400 V / 50 Hz in delta connection:

Assignment of MOVIDRIVE® MDX61B0008-5A3 ... MDX61B0110-503 (sizes 0 ... 2):

Motor		MOVIDRIVE® MDX61B...-5_3 (AC 400/500 V units) in CFC operating modes (P700)										
Δ AC 230 V / 50 Hz		0005	0008	0011	0014	0015	0022	0030	0040	0055	0075	0110
DRS71S4	M _{max} (lb in)	6.2 (55)	7.5 (66)	9.8 (87)	10 (88.5)	9.4 (83)	10 (88.5)					
	n _{trans} rpm	1669	1494	1201	1171	1242	1171					
DRS71M4	M _{max} (lb in)		8 (71)	10 (88.5)		10 (88.5)						
	n _{trans} rpm		1687	1564		1546						
DRS80S4	M _{max} (lb in)			11.4 (101)	14 (120)	11 (101)	14 (120)					
	n _{trans} rpm			1757	1658	1781	1669					
DRS80M4	M _{max} (lb in)				14 (120)	11.6 (103)	14 (120)	14 (120)				
	n _{trans} rpm				2050	1962	2091	2285				
DRS90M4	M _{max} (lb in)						15.6 (138)	20.1 (178)	27.7 (245)	28 (248)		
	n _{trans} rpm						1980	1857	1646	1658		
DRS90L4	M _{max} (lb in)							19.9 (176)	28.4 (251)	38.2 (338)	40 (354)	
	n _{trans} rpm							1921	1798	1646	1734	
DRS100M4	M _{max} (lb in)								27.1 (240)	36.3 (321)	40 (354)	40 (354)
	n _{trans} rpm								2080	1968	2103	2191
DRS100LC4	M _{max} (lb in)									35.5 (314)	46.5 (412)	55 (487)
	n _{trans} rpm									2121	2044	2302
DRS112M4	M _{max} (lb in)									36.2 (320)	46.8 (414)	55 (487)
	n _{trans} rpm									2094	1987	2016
DRS132S4	M _{max} (lb in)										46.5 (412)	71.7 (635)
	n _{trans} rpm										1997	1845
DRS132M4	M _{max} (lb in)											73.4 (650)
	n _{trans} rpm											1845

Note:

The data is based on a supply voltage of AC 400 V.



Assignment of MOVIDRIVE® MDX61B0150-503 ... MDX61B1320-503 (sizes 3 ... 6):

Motor			MOVIDRIVE® MDX61B...-5_3 (AC 400/500 V units) in CFC operating modes (P700)									
Δ AC 230 V / 50 Hz			0150	0220	0300	0370	0450	0550	0750	0900	1100	1320
DRS100LC4	M _{max}	Nm (lb in)	55 (487)									
	n _{trans}	rpm	2361									
DRS132S4	M _{max}	Nm (lb in)	96.4 (853)	110 (974)								
	n _{trans}	rpm	1684	1596								
DRS132M4	M _{max}	Nm (lb in)	98.9 (875)	110 (974)								
	n _{trans}	rpm	1806	1855								
DRS132MC4	M _{max}	Nm (lb in)	94.8 (839)	139 (1230)	184 (1630)	200 (1770)						
	n _{trans}	rpm	1943	1806	1655	1616						
DRS160S4	M _{max}	Nm (lb in)	93.9(831)	138 (1221)	183 (1620)	200 (1770)						
	n _{trans}	rpm	1880	1762	1639	1643						
DRS160M4	M _{max}	Nm (lb in)	93.5 (828)	138 (1220)	182 (1610)	200 (1770)						
	n _{trans}	rpm	2012	1902	1779	1801						
DRS160MC4	M _{max}	Nm (lb in)		132 (1168)	176 (1558)	200 (1770)	200 (1770)					
	n _{trans}	rpm		2056	1977	2043	2232					
DRS180S4	M _{max}	Nm (lb in)		140 (1239)	187 (1655)	200 (1770)	200 (1770)					
	n _{trans}	rpm		1932	1836	1949	2032					
DRS180M4	M _{max}	Nm (lb in)		141 (1248)	189 (1673)	232 (2053)	285 (2522)	338 (2992)	400 (3540)			
	n _{trans}	rpm		1965	1895	1822	1733	1636	1524			
DRS180L4	M _{max}	Nm (lb in)			186 (1646)	231 (2045)	286 (2531)	340 (3009)	400 (3540)			
	n _{trans}	rpm			1922	1872	1809	1739	1700			
DRS180LC4	M _{max}	Nm (lb in)					273 (2416)	326 (2885)	407 (3602)	537 (4753)	600 (5310)	
	n _{trans}	rpm					1872	1812	1716	1557	1480	
DRS200L4	M _{max}	Nm (lb in)					270 (2390)	322 (2850)	403 (3567)	530 (4691)	600 (5310)	
	n _{trans}	rpm					1889	1825	1722	1555	1467	
DRS225S4	M _{max}	Nm (lb in)						321 (2841)	403 (3567)	533 (4717)	600 (5310)	
	n _{trans}	rpm						1968	1892	1760	1719	
DRS225M4	M _{max}	Nm (lb in)							405 (3585)	542 (4797)	600 (5310)	600 (5310)
	n _{trans}	rpm							1927	1839	1878	1968
DRS225MC4	M _{max}	Nm (lb in)								514 (4549)	611 (5408)	771 (6824)
	n _{trans}	rpm								1804	1734	1614
DRS315K4	M _{max}	Nm (lb in)										
	n _{Eck}	1/min										
DRS315S4	M _{max}	Nm (lb in)										
	n _{trans}	rpm										
DRS315M4	M _{max}	Nm (lb in)										
	n _{trans}	rpm										

Note:
The data is based on a supply voltage of AC 400 V.



Motor Selection

Motor selection for asynchronous servomotors (CFC)

DRS motor selection in delta connection type (AC 230 V / 50 Hz)

Motors AC 230/400 V / 50 Hz in delta connection:

Motor			MOVIDRIVE® MDX61B...-2_3 (AC 230 V units) in CFC operating modes (P700)								
Δ AC 230 V / 50 Hz			0015	0022	0037	0055	0075	0110	0150	0220	0300
DRS71S4	M _{max}	Nm (lb in)	10 (88.5)								
	n _{trans}	rpm	375								
DRS71M4	M _{max}	Nm (lb in)	10 (88.5)								
	n _{trans}	rpm	685								
DRS80S4	M _{max}	Nm (lb in)	14 (120)								
	n _{trans}	rpm	703								
DRS80M4	M _{max}	Nm (lb in)	14 (120)								
	n _{trans}	rpm	1066								
DRS90M4	M _{max}	Nm (lb in)	21.1 (187)	25 (221)	28 (248)						
	n _{trans}	rpm	919	832	767						
DRS90L4	M _{max}	Nm (lb in)	21 (186)	25.4 (225)	40 (350)						
	n _{trans}	rpm	1007	955	779						
DRS100M4	M _{max}	Nm (lb in)		24.2 (214)	40 (350)	40 (350)					
	n _{trans}	rpm		1142	1025	1072					
DRS100LC4	M _{max}	Nm (lb in)			41.8 (370)	55 (490)	55 (490)				
	n _{trans}	rpm			1130	1154	1212				
DRS112M4	M _{max}	Nm (lb in)			42.3 (374)	55 (490)					
	n _{trans}	rpm			1103	1040					
DRS132S4	M _{max}	Nm (lb in)			41.7 (369)	65.4 (579)	87.2 (772)	110 (974)			
	n _{trans}	rpm			1118	1020	927	825			
DRS132M4	M _{max}	Nm (lb in)				66.9 (592)	89.4 (791)	110 (974)			
	n _{trans}	rpm				1074	1001	976			
DRS132MC4	M _{max}	Nm (lb in)					85 (750)	127 (1120)	165 (1460)	200 (1770)	
	n _{trans}	rpm					1093	1001	918	844	

Note:

The data is based on a supply voltage of AC 230 V.



Motors AC 230/400 V / 50 Hz in delta connection:

Motor			MOVIDRIVE® MDX61B...-2_3 (AC 230 V units) in CFC operating modes (P700)									
Δ AC 230 V / 50 Hz			0015	0022	0037	0055	0075	0110	0150	0220	0300	
DRS160S4	M _{max}	Nm (lb in)					84.1 (744)	126 (1115)	164 (1452)	200 (1770)		
	n _{trans}	rpm					1054	980	905	852		
DRS160M4	M _{max}	Nm (lb in)					83.6 (740)	125 (1110)	163 (1440)	200 (1770)		
	n _{trans}	rpm					1138	1067	993	958		
DRS160MC4	M _{max}	Nm (lb in)						120 (1062)	158 (1398)	200 (1770)	200 (1770)	
	n _{trans}	rpm						1160	1111	1164	1204	
DRS180S4	M _{max}	Nm (lb in)						127 (1124)	167 (1478)	200 (1770)		
	n _{trans}	rpm						1092	1035	1079		
DRS180M4	M _{max}	Nm (lb in)							169 (1496)	255 (2257)	305 (2699)	
	n _{trans}	rpm							1075	979	923	
DRS180L4	M _{max}	Nm (lb in)								255 (2257)	306 (2708)	
	n _{trans}	rpm								1022	979	
DRS180LC4	M _{max}	Nm (lb in)	Note: The data is based on a supply voltage of AC 230 V.								243 (2151)	293 (2593)
	n _{trans}	rpm										
DRS200L4	M _{max}	Nm (lb in)								241 (2133)	290 (2567)	
	n _{trans}	rpm								1081	1045	
DRS225S4	M _{max}	Nm (lb in)									288 (2549)	
	n _{trans}	rpm									1127	



Motor Selection

Motor selection for asynchronous servomotors (CFC)

Motor table for DRE series AC motors

Characteristic values for delta/star AC 230/400 V / 50 Hz

Motor	M_N Nm (lb in)	Mass moment of inertia J_M 10^{-4} kgm^2		Star \star (AC 400 V)				Delta Δ (AC 230 V)			
		Without brake	With brake	I_n A	$I_{q_n}^{1)}$ A	$I_{d_n}^{1)}$ A	$k_T^{1)}$ Nm/A (lb in/A)	I_n A	$I_{q_n}^{1)}$ A	$I_{d_n}^{1)}$ A	$k_T^{1)}$ Nm/A (lb in/A)
DRE80M44	5 (44)	21.5	23	1.68	1.37	0.98	3.66 (32.4)	2.91	2.37	1.69	2.11 (18.7)
DRE90M4	7.4 (65)	35.5	40	2.45	2.15	1.18	3.45 (30.5)	4.24	3.72	2.04	1.99 (17.6)
DRE90L4	10 (89)	43.5	48.5	3.35	2.64	2.06	3.78 (33.5)	5.80	4.58	3.56	2.18 (19.3)
DRE100M4	14.7 (130)	56	62	4.6	4.16	1.96	3.53 (31.2)	8.0	7.21	3.40	2.04 (18.1)
DRE100LC4	19.7 (174)	90	96	6.2	5.52	2.81	3.57(31.6)	10.7	9.57	4.87	2.06 (18.2)
DRE112M4	19.7 (174)	146	151	6.0	5.51	2.38	3.58 (31.7)	10.4	9.54	4.12	2.07 (18.3)
DRE132S4	26 (230)	190	195	8	7.35	3.17	3.54 (31.3)	13.9	12.7	5.5	2.04 (18.1)
DRE132M4	36 (320)	255	265	10.5	9.91	3.48	3.63 (32.1)	18.2	17.2	6.0	2.10 (18.6)
DRE132MC4	48.5 (429)	340	355	14.8	13.4	6.31	3.62 (32.0)	25.6	23.2	10.9	2.09 (18.5)
DRE160S4	49 (430)	370	390	14.7	13.3	6.29	3.68 (32.6)	25.5	23.0	10.9	2.13 (18.9)
DRE160M4	60 (530)	450	500	18.3	16.2	8.41	3.70 (32.7)	31.7	28.1	14.6	2.13 (18.9)
DRE160MC4	71 (630)	590	640	21.5	20.1	8.10	3.53 (31.2)	37	34.9	14.0	2.04 (18.1)
DRE180S4	71 (628)	895	955	21	18.7	9.26	3.79 (33.5)	36	32.5	16.0	2.19 (19.4)
DRE180M4	97 (859)	1110	1170	28	25.9	10.4	3.75 (33.2)	48	44.8	18.1	2.17 (19.2)
DRE180L4	120 (1062)	1300	1440	34	31.2	14.1	3.85 (34.1)	59	54	24.4	2.22 (19.6)
DRE180LC4	142 (1260)	1680	1815	42	36.3	20.8	3.91 (34.6)	73	62.8	36.0	2.26 (20.0)
DRE200L4	194 (1717)	2360	2500	57	53.6	19.4	3.62 (32.0)	99	92.8	33.6	2.09 (18.5)
DRE225S4	240 2124)	2930	3160	70	65.1	25.7	3.69 (32.7)	121	113	44.5	2.13 (18.9)
DRE225M4	290 (2567)	3430	3660	84	78.3	30.5	3.70 (32.7)	145	136	52.9	2.14 (18.9)
DRE315K4	708 (6270)	18400	19500	196	183	69.6	3.86 (34.2)	340	317	121	2.23 (19.7)
DRE315S4	850 (7520)	22500	23600	230	208	95.6	4.08 (36.1)	425	360	166	2.36 (20.9)
DRE315M4	1030 (9116)	27900	29000	275	260	88.8	3.96 (35.0)	480	451	154	2.28 (20.2)

1) Applies in the basic speed range up to n_{trans} .



DRE motor selection with delta/star connection type (AC 230/400 V / 50 Hz)

1. Motors AC 230/400 V / 50 Hz in Δ connection or motors AC 400/690 V / 50 Hz in Δ connection

Assignment of MOVIDRIVE® MDX61B0005-5A3 ... MDX61B0110-503 (sizes 0 ... 2):

Motor		MOVIDRIVE® MDX61B...-5_3 (AC 400/500 V units) in CFC operating modes (P700)										
Δ AC 400 V / 50 Hz		0005	0008	0011	0014	0015	0022	0030	0040	0055	0075	0110
DRE80M4	M_{max} Nm (lb in)	14 (120)	14 (120)			14 (120)						
	n_{trans} rpm	849	884			890						
DRE90M4	M_{max} Nm (lb in)	13.2 (117)	14 (120)	14 (120)		14 (120)						
	n_{trans} rpm	990	1037	1084		1084						
DRE90L4	M_{max} Nm (lb in)			22.2 (196)	28 (248)	21.4 (189)	28 (248)	28 (248)				
	n_{trans} rpm			902	837	914	843	867				
DRE100M4	M_{max} Nm (lb in)				27.5 (243)	20.1 (178)	28.4 (251)	36.6 (324)	40 (354)			
	n_{trans} rpm				1048	1125	1037	943	931			
DRE100LC4	M_{max} Nm (lb in)						27.6 (244)	36.1 (320)	40 (354)	40 (354)		
	n_{trans} rpm						1113	1060	1166	1212		
DRE112M4	M_{max} Nm (lb in)						28.2 (250)	36.6 (324)	40 (354)			
	n_{trans} rpm						1084	1020	1074			
DRE132S4	M_{max} Nm (lb in)							35.7 (316)	49.5 (438)	55 (490)	55 (490)	
	n_{trans} rpm							1113	1044	1103	1123	
DRE132M4	M_{max} Nm (lb in)								50.4 (446)	67.1 (594)	86.5 (766)	110 (974)
	n_{trans} rpm								1079	1015	932	830
DRE132MC4	M_{max} Nm (lb in)									64.3 (569)	84.3 (746)	110 (974)
	n_{trans} rpm									1103	1059	1079
DRE160S4	M_{max} Nm (lb in)									64.9 (574)	85.1 (753)	110 (974)
	n_{trans} rpm									1098	1050	1072
DRE160M4	M_{max} Nm (lb in)										82.7 (732)	128 (1133)
	n_{trans} rpm										1103	1019
DRE160MC4	M_{max} Nm (lb in)											124 (1097)
	n_{trans} rpm											1129
DRE180S4	M_{max} Nm (lb in)											132 (1168)
	n_{trans} rpm											1026
DRE180M4	M_{max} Nm (lb in)											129 (1142)
	n_{trans} rpm											1092

Note: The data is based on a supply voltage of AC 400 V.



Motor Selection

Motor selection for asynchronous servomotors (CFC)

Assignment of MOVIDRIVE® MDX61B0150-503 ... MDX61B1320-503 (sizes 3 ... 6):

Motor		MOVIDRIVE® MDX61B...-5_3 (AC 400/500 V units) in CFC operating modes (P700)									
AC 400 V / 50 Hz		0150	0220	0300	0370	0450	0550	0750	0900	1100	1320
DRE160M4	M _{max}	Nm (lb in)	174 (1540)	200 (1770)							
	n _{trans}	rpm	931	900							
DRE160MC4	M _{max}	Nm (lb in)	167 (1478)	200 (1770)							
	n _{trans}	rpm	1059	1072							
DRE180S4	M _{max}	Nm (lb in)	179 (1584)	200 (1770)							
	n _{trans}	rpm	946	946							
DRE180M4	M _{max}	Nm (lb in)	176 (1558)	200 (1770)							
	n _{trans}	rpm	1035	1115							
DRE180L4	M _{max}	Nm (lb in)	176 (1558)	260 (2301)	342 (3027)	400 (3540)					
	n _{trans}	rpm	1035	962	883	830					
DRE180LC4	M _{max}	Nm (lb in)		257 (2275)	342 (3027)	400 (3540)					
	n _{trans}	rpm		959	899	873					
DRE200L4	M _{max}	Nm (lb in)		240 (2124)	318 (2815)	390 (3452)	478 (4231)	565 (5001)	600 (5310)		
	n _{trans}	rpm		1086	1025	966	893	823	796		
DRE225S4	M _{max}	Nm (lb in)			317 (2806)	391 (3461)	481 (4257)	571 (5054)	600 (5310)		
	n _{trans}	rpm			1104	1060	1004	949	928		
DRE225M4	M _{max}	Nm (lb in)				390 (3452)	482 (4266)	574 (5080)	600 (5310)		
	n _{trans}	rpm				1122	1081	1037	1092		
DRE315K4	M _{max}	Nm (lb in)							948 (8390)	1128 (9984)	1424 (12600)
	n _{trans}	rpm							1068	1056	1030
DRE315S4	M _{max}	Nm (lb in)								1158 (10249)	1477 (13073)
	n _{trans}	rpm								1071	1053
DRE315M4	M _{max}	Nm (lb in)									1441 (12750)
	n _{trans}	rpm									1043

Note:

The data is based on a supply voltage of AC 400 V.



2. Motors AC 230/400 V / 50 Hz in delta connection:

Assignment of MOVIDRIVE® MDX61B0008-5A3 ... MDX61B0110-503 (sizes 0 ... 2):

Motor		MOVIDRIVE® MDX61B...-5_3 (AC 400/500 V units) in CFC operating modes (P700)										
Δ AC 230 V / 50 Hz		0005	0008	0011	0014	0015	0022	0030	0040	0055	0075	0110
DRE80M4	M _{max} Nm (lb in)		9.4 (83)	12.5 (111)	14 (120)	12.1 (107)	14 (120)	14 (120)				
	n _{trans} rpm		1898	1787	1875	1804	1898	1957				
DRE90M4	M _{max} Nm (lb in)				14 (120)	11.2 (99.1)	14 (120)	14 (120)				
	n _{trans} rpm				1980	1951	2015	2179				
DRE90L4	M _{max} Nm (lb in)						16.2 (143)	21.5 (190)	28 (250)	28 (250)		
	n _{trans} rpm						1839	1757	1716	1834		
DRE100M4	M _{max} Nm (lb in)							20.2 (179)	28.2 (250)	37.6 (333)	40 (354)	
	n _{trans} rpm							2074	1962	1828	1904	
DRE100LC4	M _{max} Nm (lb in)								27.4 (243)	37.1 (328)	40 (354)	40 (354)
	n _{trans} rpm								2033	1957	2185	2384
DRE112M4	M _{max} Nm (lb in)								28 (250)	37.6 (333)	40 (354)	40 (354)
	n _{trans} rpm								1967	1870	2026	2070
DRE132S4	M _{max} Nm (lb in)									36.7 (325)	47.8 (423)	55 (487)
	n _{trans} rpm									2002	1923	2109
DRE132M4	M _{max} Nm (lb in)										48.7 (431)	74.4 (658)
	n _{trans} rpm										1967	1816
DRE132MC4	M _{max} Nm (lb in)											71.7 (635)
	n _{trans} rpm											1958
DRE160S4	M _{max} Nm (lb in)											72.4 (641)
	n _{trans} rpm											1955

Note:

The data is based on a supply voltage of AC 400 V.



Motor Selection

Motor selection for asynchronous servomotors (CFC)

Assignment of MOVIDRIVE® MDX61B0150-503 ... MDX61B1320-503 (sizes 3 ... 6):

Motor		MOVIDRIVE® MDX61B...-5_3 (AC 400/500 V units) in CFC operating modes (P700)										
Δ AC 230 V / 50 Hz		0150	0220	0300	0370	0450	0550	0750	0900	1100	1320	
DRE132M4	M _{max}	Nm (lb in)	99.8 (883)	110 (974)								
	n _{trans}	rpm	1655	1591								
DRE132MC4	M _{max}	Nm (lb in)	97.8 (866)	110 (974)								
	n _{trans}	rpm	1875	2073								
DRE160S4	M _{max}	Nm (lb in)	98.7 (874)	110 (974)								
	n _{trans}	rpm	1863	2065								
DRE160M4	M _{max}	Nm (lb in)	96.8 (857)	142 (1257)	188 (1664)	200 (1770)						
	n _{trans}	rpm	1938	1814	1683	1700						
DRE160MC4	M _{max}	Nm (lb in)	93.3(826)	137 (1213)	180 (1593)	200 (1770)	200 (1770)					
	n _{trans}	rpm	2100	2003	1898	1938	1990					
DRE180S4	M _{max}	Nm (lb in)	99.1(877)	147 (1301)	194 (1717)	200 (1770)						
	n _{trans}	rpm	1922	1816	1696	1759						
DRE180M4	M _{max}	Nm (lb in)		144 (1275)	191 (1690)	200 (1770)	200 (1770)					
	n _{trans}	rpm		1925	1839	1995	2058					
DRE180L4	M _{max}	Nm (lb in)		143 (1266)	192 (1699)	236 (2089)	290 (2567)	344 (3045)	400 (3540)			
	n _{trans}	rpm		1889	1836	1779	1703	1623	1570			
DRE180LC4	M _{max}	Nm (lb in)			185 (1637)	232 (2053)	289 (2558)	344 (3045)	400 (3540)	400 (3540)		
	n _{trans}	rpm			1793	1749	1690	1623	1617	1670		
DRE200L4	M _{max}	Nm (lb in)					269 (2381)	320 (2832)	400 (3540)	526 (4655)	600 (5310)	
	n _{trans}	rpm					1895	1834	1728	1561	1464	
DRE225S4	M _{max}	Nm (lb in)						319 (2823)	401 (3549)	530 (4691)	600 (5310)	
	n _{trans}	rpm						1957	1883	1754	1708	
DRE225M4	M _{max}	Nm (lb in)							400 (3540)	532 (4709)	600 (5310)	600 (5310)
	n _{trans}	rpm							1980	1886	1883	1980
DRE225MC4	M _{max}	Nm (lb in)										
	n _{trans}	rpm										
DRE315K4	M _{max}	Nm (lb in)										
	n _{trans}	rpm										
DRE315S4	M _{max}	Nm (lb in)										
	n _{trans}	rpm										
DRE315M4	M _{max}	Nm (lb in)										
	n _{trans}	rpm										

Note:

The data is based on a supply voltage of AC 400 V.



DRE motor selection in delta connection type (AC 230 V / 50 Hz)

Motors AC 230/400 V / 50 Hz in delta connection:

Motor			MOVIDRIVE® MDX61B...-2_3 (AC 230 V units) in CFC operating modes (P700)								
Δ AC 230 V / 50 Hz			0015	0022	0037	0055	0075	0110	0150	0220	0300
DRE80M4	M _{max}	Nm (lb in)	14 (120)								
	n _{trans}	rpm	890								
DRE90M4	M _{max}	Nm (lb in)	14 (120)								
	n _{trans}	rpm	1084								
DRE90L4	M _{max}	Nm (lb in)	22.5 (896)	27 (240)	28 (250)						
	n _{trans}	rpm	896	832	867						
DRE100M4	M _{max}	Nm (lb in)	21.2 (188)	25.3 (224)	40 (350)						
	n _{trans}	rpm	1113	1072	925						
DRE100LC4	M _{max}	Nm (lb in)		24.5 (217)	40 (350)	40 (350)					
	n _{trans}	rpm		1136	1089	1212					
DRE112M4	M _{max}	Nm (lb in)		25.1 (222)	40 (350)	40 (350)					
	n _{trans}	rpm		1103	1040	1074					
DRE132S4	M _{max}	Nm (lb in)			43.1 (381)	55 (490)					
	n _{trans}	rpm			1079	1108					
DRE132M4	M _{max}	Nm (lb in)			43.8 (388)	68 (600)	90.3 (799)	110 (974)			
	n _{trans}	rpm			1108	1010	913	830			
DRE132MC4	M _{max}	Nm (lb in)				65.1 (5576)	88.1 (780)	110 (974)			
	n _{trans}	rpm				1103	1049	1084			
DRE160S4	M _{max}	Nm (lb in)				65.8 (582)	88.9 (787)	110 (974)			
	n _{trans}	rpm				1098	1041	1072			
DRE160M4	M _{max}	Nm (lb in)					86.7 (767)	129 (1142)	168 (1487)	200 (1770)	
	n _{trans}	rpm					1094	1015	940	900	
DRE160MC4	M _{max}	Nm (lb in)					83.7 (741)	124 (1097)	162 (1434)	200 (1770)	
	n _{trans}	rpm					1190	1129	1067	1072	
DRE180S4	M _{max}	Nm (lb in)					88.6 (784)	133 (1177)	174 (1540)	200 (1770)	
	n _{trans}	rpm					1089	1022	956	946	
DRE180M4	M _{max}	Nm (lb in)						130 (1151)	171 (1513)	200 (1770)	
	n _{trans}	rpm						1092	1042	1115	
DRE180L4	M _{max}	Nm (lb in)							171 (1513)	260 (2301)	311 (2753)
	n _{trans}	rpm							1039	962	913
DRE180LC4	M _{max}	Nm (lb in)								257 (2275)	310 (2744)
	n _{trans}	rpm								959	923
DRE200L4	M _{max}	Nm (lb in)								240 (2124)	288 (2549)
	n _{trans}	rpm								1086	1048
DRE225S4	M _{max}	Nm (lb in)									285 (2522)
	n _{trans}	rpm									1122

Note:
The data is based on a supply voltage of AC 230 V.



Motor Selection

Motor selection for asynchronous servomotors (CFC)

Motor table for DRP series AC motors

Characteristic values for delta/star AC 230/400 V / 50 Hz

Motor	M_N Nm (lb in)	Mass moment of inertia J_M 10^{-4} kgm ²		Star \star (AC 400 V)				Delta Δ (AC 230 V)			
		Without brake	With brake	I_n A	$I_{q_n}^{1)}$ A	$I_{d_n}^{1)}$ A	$k_T^{1)}$ Nm/A (lb in/A)	I_n A	$I_{q_n}^{1)}$ A	$I_{d_n}^{1)}$ A	$k_T^{1)}$ Nm/A (lb in/A)
DRP90M4	4.95 (43.8)	35.5	40	1.81	1.38	1.17	3.58 (31.7)	3.14	2.39	2.02	2.07 (18.3)
DRP90L4	7.3 (65)	43.5	48.5	2.4	1.86	1.52	3.93 (34.8)	4.16	3.22	2.63	2.27 (20.1)
DRP100M4	9.9 (88)	56	62	3.2	2.82	1.51	3.51 (31.1)	5.54	4.88	2.62	2.03 (18.0)
DRP100L4	14.6 (129)	90	96	4.75	3.92	2.68	3.72 (32.9)	8.23	6.79	4.65	2.15 (19.0)
DRP112M4	19.7 (174)	146	151	6	5.53	2.34	3.57(31.6)	10.4	9.6	4.1	2.06 (18.2)
DRP132M4	26 (230)	255	265	7.7	7.15	2.85	3.64 (32.2)	13.3	12.4	4.9	2.10 (18.6)
DRP132MC4	35.5 (314)	340	355	11	9.93	4.69	3.57 (31.6)	19	17.2	8.1	2.06 (18.2)
DRP160S4	35.5 (314)	370	390	10.9	9.39	5.53	3.78 (33.5)	19	16.3	9.6	2.18 (19.3)
DRP160M4	48.5 (429)	450	500	14.5	13.4	6.06	3.62 (32.0)	25	23.2	10.5	2.09 (18.5)
DRP160MC4	59 (520)	590	640	17.8	16.6	5.42	3.55 (31.4)	31	28.8	9.4	2.05 (18.1)
DRP180S4	60 (530)	895	955	18	15.2	8.63	3.94 (34.9)	31	26.4	15.0	2.28 (20.2)
DRP180M4	71 (630)	1110	1170	21	18.6	8.46	3.83 (33.9)	36	32.1	14.7	2.21 (19.6)
DRP180L4	97 (860)	1300	1440	28	24.4	12.8	3.97 (35.1)	48	42.3	22.2	2.29 (20.3)
DRP180LC4	119 (1050)	1790	1930	35	31.1	15.8	3.82 (33.8)	61	53.9	27.4	2.21 (19.6)
DRP200L4	142 (1257)	2360	2500	41	37.6	16.3	3.77 (33.4)	71	65.2	28.2	2.18 (19.3)
DRP225S4	193 (1708)	2930	3160	55	49.4	23.4	3.91 (34.6)	95	85.5	40.5	2.26 (20.0)
DRP225M4	240 (2120)	3430	3660	69	63.8	26.4	3.76 (33.3)	120	110	45.7	2.17 (19.2)
DRP315K4	580 (5130)	18400	19500	159	149	54.8	3.89 (34.4)	340	259	94.9	2.24 (19.8)
DRP315S4	710 (6280)	22500	23600	192	176	76.2	4.03 (35.7)	-	-	-	-
DRP315M4	850 (7520)	27900	29000	230	212	89.2	4.01 (35.5)	-	-	-	-
DRP315L4	1030 (9116)	31900	33000	275	252	110	4.09 (36.2)	-	-	-	-

1) Applies in the basic speed range up to n_{trans} .



DRP motor selection with delta/star connection type (AC 230/400 V / 50 Hz)

1. Motors AC 230/400 V / 50 Hz in Δ connection or motors AC 400/690 V / 50 Hz in Δ connection

Assignment of MOVIDRIVE® MDX61B0005-5A3 ... MDX61B0110-503 (sizes 0 ... 2):

Motor		MOVIDRIVE® MDX61B...-5_3 (AC 400/500 V units) in CFC operating modes (P700)											
		Δ AC 400 V / 50 Hz	0005	0008	0011	0014	0015	0022	0030	0040	0055	0075	0110
DRP90M4	M_{max}	Nm (lb in)	13.7 (121)	14 (124)			14 (124)						
	n_{trans}	rpm	890	943			955						
DRP90L4	M_{max}	Nm (lb in)	14 (124)	14 (124)	14 (124)		14 (202)						
	n_{trans}	rpm	914	1037	1101		1101						
DRP100M4	M_{max}	Nm (lb in)			21.2 (188)	27.7 (245)	20.5 (181)	28 (248)	28 (248)				
	n_{trans}	rpm			984	896	996	896	925				
DRP100L4	M_{max}	Nm (lb in)				28 (248)	20 (177)	29 (257)	37.8 (335)	40 (354)			
	n_{trans}	rpm				1002	1066	990	919	972			
DRP112M4	M_{max}	Nm (lb in)						28.2 (250)	36.5 (323)	40 (354)			
	n_{trans}	rpm						1088	1025	1079			
DRP132M4	M_{max}	Nm (lb in)							36.8 (326)	50.9 (451)	55 (487)		
	n_{trans}	rpm							1186	1113	1196		
DRP132MC4	M_{max}	Nm (lb in)								48.2 (427)	65.1 (576)	84.4 (747)	110 (974)
	n_{trans}	rpm								1044	1001	947	908
DRP160S4	M_{max}	Nm (lb in)								49.8 (441)	67.9 (601)	88.5 (783)	110 (974)
	n_{trans}	rpm								1006	966	918	936
DRP160M4	M_{max}	Nm (lb in)									64.6 (572)	84.5 (748)	110 (1151)
	n_{trans}	rpm									1147	1103	1133
DRP160MC4	M_{max}	Nm (lb in)										83.7 (741)	127 (1124)
	n_{trans}	rpm										1204	1111
DRP180S4	M_{max}	Nm (lb in)	Note: The data is based on a supply voltage of AC 400 V.									87.6 (775)	136 (1204)
	n_{trans}	rpm										1055	976
DRP180M4	M_{max}	Nm (lb in)										86.2 (763)	134 (1186)
	n_{trans}	rpm										1082	1019
DRP180L4	M_{max}	Nm (lb in)											133 (1177)
	n_{trans}	rpm											1026



Motor Selection

Motor selection for asynchronous servomotors (CFC)

Assignment of MOVIDRIVE® MDX61B0150-503 ... MDX61B1320-503 (sizes 3 ... 6):

Motor			MOVIDRIVE® MDX61B...-5_3 (AC 400/500 V units) in CFC operating modes (P700)									
AC 400 V / 50 Hz			0150	0220	0300	0370	0450	0550	0750	0900	1100	1320
DRP160MC4	M _{max}	Nm (lb in)	170 (1505)	200 (1770)								
	n _{trans}	rpm	1015	953								
DRP180S4	M _{max}	Nm (lb in)	184 (1629)	200 (1770)								
	n _{trans}	rpm	893	889								
DRRP180M4	M _{max}	Nm (lb in)	181 (1602)	200 (1770)								
	n _{trans}	rpm	946	952								
DRP180L4	M _{max}	Nm (lb in)	183 (1620)	200 (1770)								
	n _{trans}	rpm	979	1128								
DRP180LC4	M _{max}	Nm (lb in)	173 (1531)	257 (2275)	339 (3000)	400 (3540)						
	n _{trans}	rpm	1062	999	926	886						
DRP200L4	M _{max}	Nm (lb in)	170 (1505)	252 (2230)	333 (2947)	400 (3540)						
	n _{trans}	rpm	1092	1025	952	896						
DRP225S4	M _{max}	Nm (lb in)		254 (2248)	340 (3009)	419 (3708)	515 (4558)	600 (5310)				
	n _{trans}	rpm		969	925	881	826	788				
DRP225M4	M _{max}	Nm (lb in)			321 (2841)	397 (3514)	489 (4328)	580 (5133)	600 (5310)			
	n _{trans}	rpm			1125	1086	1040	990	1010			
DRP315K4	M _{max}	Nm (lb in)							726 (6426)	966 (8550)	1144 (10125)	1439 (12736)
	n _{trans}	rpm							1028	1008	990	957
DRP315S4	M _{max}	Nm (lb in)								976 (8638)	1164 (10302)	1472 (13028)
	n _{trans}	rpm								982	972	952
DRP315M4	M _{max}	Nm (lb in)									1144 (10125)	1455 (12878)
	n _{trans}	rpm									1053	1041
DRP315L4	M _{max}	Nm (lb in)										1460 (12922)
	n _{trans}	rpm										1035

Note:

The data is based on a supply voltage of AC 400 V.



2. Motors AC 230/400 V / 50 Hz in delta connection:

Assignment of **MOVIDRIVE® MDX61B0008-5A3 ... MDX61B0110-503** (sizes 0 ... 2):

Motor		MOVIDRIVE® MDX61B...-5_3 (AC 400/500 V units) in CFC operating modes (P700)										
Δ AC 230 V / 50 Hz		0005	0008	0011	0014	0015	0022	0030	0040	0055	0075	0110
DRP90M4	M _{max} Nm (lb in)			12 (106)	14 (124)	11.6 (103)	14 (124)	14 (124)				
	n _{trans} rpm			1769	1839	1781	1869	1945				
DRP90L4	M _{max} Nm (lb in)				14 (124)	12.2 (108)	14 (124)	14 (124)				
	n _{trans} rpm				1951	1716	1992	2232				
DRP100M4	M _{max} Nm (lb in)						15.9 (141)	20.6 (182)	28 (248)	28 (248)		
	n _{trans} rpm						1951	1869	1746	1863		
DRP100L4	M _{max} Nm (lb in)							20.1 (178)	28.8 (255)	38.9 (344)	40 (354)	
	n _{trans} rpm							1945	1857	1752	1945	
DRP112M4	M _{max} Nm (lb in)								28 (248)	37.5 (332)	40 (354)	
	n _{trans} rpm								1982	1884	2036	
DRP132M4	M _{max} Nm (lb in)									37.9 (335)	49.2 (435)	55 (487)
	n _{trans} rpm									2118	2036	2236
DRP132MC4	M _{max} Nm (lb in)										46.5 (412)	72.3 (640)
	n _{trans} rpm										1879	1787
DRP160S4	M _{max} Nm (lb in)										47.9 (424)	75.6 (669)
	n _{trans} rpm										1806	1722
DRP160M4	M _{max} Nm (lb in)											72 (637)
	n _{trans} rpm											2025
DRP160MC4	M _{max} Nm (lb in)											71.5 (633)
	n _{trans} rpm											2188
DRP180S4	M _{max} Nm (lb in)											73.6 (651)
	n _{trans} rpm											1909

Note:
The data is based on a supply voltage of AC 400 V.



Motor Selection

Motor selection for asynchronous servomotors (CFC)

Assignment of MOVIDRIVE® MDX61B0150-503 ... MDX61B1320-503 (sizes 3 ... 6):

Motor		MOVIDRIVE® MDX61B...-5_3 (AC 400/500 V units) in CFC operating modes (P700)									
Δ AC 230 V / 50 Hz		0150	0220	0300	0370	0450	0550	0750	0900	1100	1320
DRP132MC4	M _{max}	Nm (lb in)	97.5 (863)	110 (974)							
	n _{trans}	rpm	1679	1743							
DRP160S4	M _{max}	Nm (lb in)	102 (903)	110 (974)							
	n _{trans}	rpm	1634	1788							
DRP160M4	M _{max}	Nm (lb in)	98 (867)	110 (974)							
	n _{trans}	rpm	1942	2157							
DRP160MC4	M _{max}	Nm (lb in)	96.9(858)	140 (1239)	184 (1629)	200 (1770)					
	n _{trans}	rpm	2113	1973	1823	1779					
DRP180S4	M _{max}	Nm (lb in)	102(903)	151 (1336)	199 (1761)	200 (1770)					
	n _{trans}	rpm	1852	1733	1607	1656					
DRP180M4	M _{max}	Nm (lb in)	100(885)	148 (1310)	195 (1726)	200 (1770)					
	n _{trans}	rpm	1895	1796	1683	1779					
DRP180L4	M _{max}	Nm (lb in)		149 (1319)	199 (1761)	200 (1770)	200 (1770)				
	n _{trans}	rpm		1806	1743	1982	2091				
DRP180LC4	M _{max}	Nm (lb in)		189 (1673)	233 (2062)	288 (2549)	342 (3027)	400 (3540)			
	n _{trans}	rpm		1872	1819	1749	1680	1633			
DRP200L4	M _{max}	Nm (lb in)			185 (2062)	229 (2027)	282 (2496)	335 (2965)	400 (3540)		
	n _{trans}	rpm			1913	1860	1787	1713	1634		
DRP225S4	M _{max}	Nm (lb in)				229 (2027)	286 (2531)	343 (3036)	429 (3797)	567 (5018)	600 (5310)
	n _{trans}	rpm				1740	1699	1658	1585	1461	1456
DRP225M4	M _{max}	Nm (lb in)						324 (2868)	407 (3602)	539 (4771)	600 (5310)
	n _{trans}	rpm						1986	1921	1813	1801
DRP315K4	M _{max}	Nm (lb in)									809 (7160)
	n _{trans}	rpm									1800

Note:
The data is based on a supply voltage of AC 400 V.



DRP motor selection in delta connection type (AC 230 V / 50 Hz)

Motors AC 230/400 V / 50 Hz in delta connection:

Motor			MOVIDRIVE® MDX61B...-2_3 (AC 230 V units) in CFC operating modes (P700)								
Δ AC 230 V / 50 Hz			0015	0022	0037	0055	0075	0110	0150	0220	0300
DRP90M4	M _{max}	Nm (lb in)	14 (124)								
	n _{trans}	rpm	953								
DRP90L4	M _{max}	Nm (lb in)	14 (124)								
	n _{trans}	rpm	1101								
DRP100M4	M _{max}	Nm (lb in)	21.6 (191)	25.6 (227)	40 (354)						
	n _{trans}	rpm	978	925	925						
DRP100L4	M _{max}	Nm (lb in)	21.2 (188)	25.7 (227)	40 (354)	40 (354)					
	n _{trans}	rpm	1054	1019	949	972					
DRP112M4	M _{max}	Nm (lb in)		25.1 (222)	40 (354)	40 (354)					
	n _{trans}	rpm		1113	1044	1079					
DRP132M4	M _{max}	Nm (lb in)			44.4 (393)	55 (487)	55 (487)				
	n _{trans}	rpm			1147	1196	1206				
DRP132MC4	M _{max}	Nm (lb in)				65.9 (583)	88.1 (780)	110 (974)			
	n _{trans}	rpm				1001	937	908			
DRP160S4	M _{max}	Nm (lb in)				68.8 (609)	92.5 (819)	110 (974)			
	n _{trans}	rpm				966	909	936			
DRP160M4	M _{max}	Nm (lb in)				65.4 (579)	88.3 (782)	110 (974)	110 (974)		
	n _{trans}	rpm				1147	1094	1138	1177		
DRP160MC4	M _{max}	Nm (lb in)					87.4 (774)	128 (1133)	165 (1460)	200 (1770)	
	n _{trans}	rpm					1195	1111	1028	953	
DRP180S4	M _{max}	Nm (lb in)					91.9 (813)	137 (1213)	179 (1584)	200 (1770)	
	n _{trans}	rpm					1049	976	903	889	
DRP180M4	M _{max}	Nm (lb in)					90.3 (799)	135 (1195)	175 (1549)	200 (1770)	
	n _{trans}	rpm					1079	1016	956	952	
DRP180L4	M _{max}	Nm (lb in)						134 (1186)	177 (1567)	200 (1770)	
	n _{trans}	rpm						1026	986	1128	
DRP180LC4	M _{max}	Nm (lb in)							168 (1487)	257 (2275)	308 (2726)
	n _{trans}	rpm							1065	999	956
DRP200L4	M _{max}	Nm (lb in)							164 (1452)	252 (2230)	302 (2673)
	n _{trans}	rpm							1095	1025	981
DRP225S4	M _{max}	Nm (lb in)								254 (2248)	307 (2717)
	n _{trans}	rpm								969	943
DRP225M4	M _{max}	Nm (lb in)									290 (2567)
	n _{trans}	rpm									1139
DRP225MC4	M _{max}	Nm (lb in)									
	n _{trans}	rpm									

Note:
The data is based on a supply voltage of AC 230 V.



Motor Selection

Motor selection for asynchronous servomotors (CFC)

Motor table DRS AC motors (characteristic value with double-star/star connection AC 230/460 V / 60 Hz)

Motor	M_N Nm (lb in)	Mass moment of inertia J_M		Star Δ (AC 460 V)				Double-star $\Delta\Delta$ (AC 230 V)			
		Without brake	With brake	I_n	$I_{q_n^{(1)}}$	$I_{d_n^{(1)}}$	$k_T^{(1)}$	I_n	$I_{q_n^{(1)}}$	$I_{d_n^{(1)}}$	$k_T^{(1)}$
		10^{-4} kgm^2		A	A	A	Nm/A (lb in/A)	A	A	A	Nm/A (lb in/A)
DRS71S4	2.1 (19)	4.9	6.2	0.92	0.72	0.58	2.93 (25.9)	1.84	1.43	1.16	1.47 (13.0)
DRS71M4	3.1 (27)	7.1	8.4	1.25	1.00	0.75	3.09 (27.3)	2.50	2.00	1.49	1.55 (13.7)
DRS80S4	4.2 (37.2)	14.9	16.4	1.66	1.23	1.12	3.43 (30.4)	3.32	2.45	2.24	1.71 (15.1)
DRS80M4	6.1 (54)	21.5	26	2.14	1.75	1.23	3.48 (30.8)	4.28	3.50	2.46	1.74 (15.4)
DRS90M4	8.4 (74)	35.5	40	2.87	2.52	1.38	3.34 (29.6)	5.74	5.03	2.76	1.67 (14.8)
DRS90L4	12.2 (108)	43.5	49.5	4.1	3.33	2.37	3.66 (32.4)	8.2	6.66	4.75	1.83 (16.2)
DRS100M4	21 (185)	56	62	6.65	6.19	2.42	3.39 (30.0)	13.3	12.4	4.84	1.70 (15.0)
DRS100L4	22.5 (197)	68.3	74.3	7.3	6.25	3.78	3.60 (31.9)	14.6	12.5	7.56	1.80 (15.9)
DRS112M4	22 (194)	146	151	6.8	6.41	2.26	3.46 (30.6)	13.6	12.8	4.52	1.73 (15.3)
DRS132S4	30 (270)	190	200	9.4	8.8	3.36	3.43 (30.4)	18.8	17.6	6.72	1.71 (15.1)
DRS132M4	41 (362)	255	265	12.4	11.7	4.01	3.50 (31.0)	24.8	23.5	8.02	1.75 (15.5)
DRS132MC4	50 (441)	342	355	16	14.7	6.33	3.40 (30.2)	32	29.4	12.7	1.70 (15.1)
DRS160S4	50 (441)	370	420	15.9	14.2	7.20	3.53 (31.2)	31.8	28.4	14.4	1.76 (15.6)
DRS160M4	60 (528)	450	500	18.8	17.5	7.00	3.44 (30.4)	37.6	34.9	14.0	1.72 (15.2)
DRS160MC4	81 (716)	590	640	26.5	24.7	9.57	3.28 (29.0)	53.0	49.4	19.1	1.64 (14.5)
DRS180S4	81 (720)	895	955	25.5	23.6	9.68	3.43 (30.4)	51.0	47.2	19.4	1.72 (15.2)
DRS180M4	100 (881)	1110	1250	30.5	27.0	14.1	3.70 (32.7)	61.0	54.1	28.2	1.85 (16.3)
DRS180L4	118 (1051)	1300	1440	35.9	32.1	16.0	3.70 (32.7)	71.8	64.3	32.1	1.85 (16.4)
DRS180LC4	162 (1433)	1680	1910	48.5	45.5	169.9	3.54 (31.3)	97.0	90.9	33.8	1.77 (15.7)
DRS200L4	161 (1429)	2360	2590	51	47.9	17.6	3.36 (29.7)	102	95.8	35.1	1.68 (14.8)
DRS225S4	198 (1757)	2930	3160	61	56.6	22.6	3.50 (31.0)	122	113	45.3	1.75 (15.5)
DRS225M4	240 (2140)	3430	3660	72	68.7	21.7	3.50 (31.0)	144	137	43.4	1.75 (15.5)
DRS225MC4	295 (2612)	4330	4560	87.9	84.5	24.2	3.49 (30.9)	176	169	48.4	1.75 (15.5)

1) Applies in the basic speed range up to n_{trans} .



DRS motor selection in double-star/star connection type (AC 230/400 V / 60 Hz)

1. Motors AC 230/460 V / 60 Hz in star connection

Assignment of MOVIDRIVE® MDX61B0005-5A3 ... MDX61B0110-503 (sizes 0 ... 2):

Motor		MOVIDRIVE® MDX61B...-5_3 (AC 400/500 V units) in CFC operating modes (P700)										
AC 460 V / 60 Hz		0005	0008	0011	0014	0015	0022	0030	0040	0055	0075	0110
DRS71S4	M _{max} Nm (lb in)	10 (88.5)				10 (88.5)						
	n _{trans} rpm	439				439						
DRS71M4	M _{max} Nm (lb in)	10 (88.5)				10 (88.5)						
	n _{trans} rpm	820				820						
DRS80S4	M _{max} Nm (lb in)	13 (115)	14 (124)			14 (124)						
	n _{trans} rpm	978	955			960						
DRS80M4	M _{max} Nm (lb in)	13.2 (117)	14 (124)	14 (124)		14 (124)						
	n _{trans} rpm	1130	1195	1259		1259						
DRS90M4	M _{max} Nm (lb in)		15.3 (135)	20.1 (178)	26.2 (232)	19.4 (172)	27.1 (240)	28 (248)				
	n _{trans} rpm		1136	1025	878	1037	855	837				
DRS90L4	M _{max} Nm (lb in)				28.1 (249)	20.3 (180)	29.1 (258)	37.6 (333)	40 (354)			
	n _{trans} rpm				1025	1130	1013	896	873			
DRS100M4	M _{max} Nm (lb in)						26.5 (235)	23.4 (207)	40 (354)			
	n _{trans} rpm						1394	1318	1353			
DRS100L4	M _{max} Nm (lb in)							34.9 (309)	40 (354)	40 (354)		
	n _{trans} rpm							1171	1289	1377		
DRS112M4	M _{max} Nm (lb in)						27.1 (240)	35 (310)	48 (425)	55 (487)		
	n _{trans} rpm						1406	1342	1220	1181		
DRS132S4	M _{max} Nm (lb in)								47.3 (419)	63.1 (558)	81.2 (719)	110 (974)
	n _{trans} rpm								1280	1190	1081	915
DRS132M4	M _{max} Nm (lb in)								47.7 (422)	63.9 (566)	82.5 (730)	110 (974)
	n _{trans} rpm								1395	1331	1248	1139
DRS132MC4	M _{max} Nm (lb in)									59.8 (529)	78.4 (694)	120 (1060)
	n _{trans} rpm									1401	1350	1228
DRS160S4	M _{max} Nm (lb in)									60.8 (538)	80.4 (712)	123 (1089)
	n _{trans} rpm									1212	1173	1076
DRS160M4	M _{max} Nm (lb in)										78.5 (695)	120 (1060)
	n _{trans} rpm										1357	1256
DRS160MC4	M _{max} Nm (lb in)											113 (1000)
	n _{trans} rpm											1410
DRS180S4	M _{max} Nm (lb in)											119 (1053)
	n _{trans} rpm											1261
DRS180M4	M _{max} Nm (lb in)											121 (1071)
	n _{trans} rpm											1231

Note:
The data is based on a supply voltage of AC 460 V.



Motor Selection

Motor selection for asynchronous servomotors (CFC)

Assignment of MOVIDRIVE® MDX61B0150-503 ... MDX61B1320-503 (sizes 3 ... 6):

Motor		MOVIDRIVE® MDX61B...-5_3 (AC 400/500 V units) in CFC operating modes (P700)										
AC 460 V / 60 Hz		0150	0220	0300	0370	0450	0550	0750	0900	1100	1320	
DRS132MC4	M _{max}	Nm (lb in)	161 (1420)	200 (1770)								
	n _{trans}	rpm	1100	985								
DRS160S4	M _{max}	Nm (lb in)	166 (1469)	200 (1770)								
	n _{trans}	rpm	971	892								
DRS160M4	M _{max}	Nm (lb in)	162 (1434)	200 (1770)	Note: The data is based on a supply voltage of AC 460 V.							
	n _{trans}	rpm	1147	1054								
DRS160MC4	M _{max}	Nm (lb in)	154 (1363)	200 (1770)								
	n _{trans}	rpm	1340	1331								
DRS180S4	M _{max}	Nm (lb in)	162 (1434)	200 (1770)								
	n _{trans}	rpm	1182	1145								
DRS180M4	M _{max}	Nm (lb in)	168 (1487)	248 (2195)	327 (2894)	399 (3531)	400 (3540)					
	n _{trans}	rpm	1185	1092	997	906	903					
DRS180L4	M _{max}	Nm (lb in)	167 (1478)	248 (2195)	327 (2894)	400 (3540)						
	n _{trans}	rpm	1255	1185	1105	1029						
DRS180LC4	M _{max}	Nm (lb in)		238 (2106)	314 (2779)	385 (3408)	471 (4169)	557 (4930)	600 (5310)			
	n _{trans}	rpm		1268	1198	1125	1039	952	909			
DRS200L4	M _{max}	Nm (lb in)		224 (1983)	297 (2629)	364 (3222)	445 (3939)	526 (4655)	600 (5310)			
	n _{trans}	rpm		1303	1227	1151	1057	966	890			
DRS225S4	M _{max}	Nm (lb in)		228 (2018)	305 (2699)	375 (3319)	461 (4080)	546 (4833)	600 (5310)			
	n _{trans}	rpm		1377	1321	1262	1189	1116	1069			
DRS225M4	M _{max}	Nm (lb in)			308 (2726)	378 (3346)	464 (4107)	550 (4868)	600 (5310)			
	n _{trans}	rpm			1315	1265	1201	1133	1095			
DRS225MC4	M _{max}	Nm (lb in)				372 (3292)	458 (4054)	543 (4806)	674 (5965)	885 (7833)	1042 (9223)	1200 (10621)
	n _{trans}	rpm				1403	1335	1268	1163	1002	896	802



2. Motors AC 230/460 V / 60 Hz in double-star connection:

Assignment of **MOVIDRIVE® MDX61B0008-5A3 ... MDX61B0110-503 (sizes 0 ... 2):**

Motor		MOVIDRIVE® MDX61B...-5_3 (AC 400/500 V units) in CFC operating modes (P700)											
		AC 230 V / 60 Hz	0005	0008	0011	0014	0015	0022	0030	0040	0055	0075	0110
DRS71S4	M _{max} (lb in)	Nm (50)	5.6 (60)	6.8 (78)	8.8 (88.5)	10 (75)	8.5 (88.5)	10 (88.5)					
	n _{trans}	rpm	2343	2138	1804	1617	1851	1617					
DRS71M4	M _{max} (lb in)	Nm (63)		7.1 (63)	9.3 (82)	10 (88.5)	9 (80)	10 (88.5)					
	n _{trans}	rpm		2443	2197	2144	2233	2144					
DRS80S4	M _{max} (lb in)	Nm (87)			9.8 (87)	13 (115)	9.4 (83)	13.4 (119)	14 (124)				
	n _{trans}	rpm			2554	2384	2572	2361	2548				
DRS80M4	M _{max} (lb in)	Nm (117)				13.2 (117)	9.5 (84)	13.7 (121)	14 (124)	14 (124)			
	n _{trans}	rpm				2560	2689	2543	2941	3117			
DRS90M4	M _{max} (lb in)	Nm (114)						12.9 (114)	16.9 (150)	23.3 (206)	28 (248)		
	n _{trans}	rpm						2601	2472	2255	2103		
DRS90L4	M _{max} (lb in)	Nm (152)							17.2 (152)	24.7 (219)	33.4 (296)	40 (354)	40 (354)
	n _{trans}	rpm							2525	2396	2238	2185	2244
DRS100M4	M _{max} (lb in)	Nm (270)									30.5 (270)	39.6 (350)	40 (354)
	n _{trans}	rpm									2923	2789	3210
DRS100L4	M _{max} (lb in)	Nm (271)									30.6 (271)	40 (354)	40 (354)
	n _{trans}	rpm									2566	2513	3193
DRS112M4	M _{max} (lb in)	Nm (275)									31.1 (275)	40.2 (356)	55 (487)
	n _{trans}	rpm									2880	2749	2592
DRS132S4	M _{max} (lb in)	Nm (349)										39.4 (349)	60.5 (535)
	n _{trans}	rpm										2749	2563
DRS132M4	M _{max} (lb in)	Nm (542)											61.2 (542)
	n _{trans}	rpm											2797

Note:
The data is based on a supply voltage of AC 460 V.



Motor Selection

Motor selection for asynchronous servomotors (CFC)

Assignment of MOVIDRIVE® MDX61B0150-503 ... MDX61B1320-503 (sizes 3 ... 6):

Motor			MOVIDRIVE® MDX61B...-5_3 (AC 400/500 V units) in CFC operating modes (P700)									
AC 230 V / 60 Hz			0150	0220	0300	0370	0450	0550	0750	0900	1100	1320
DRS132S4	M _{max}	Nm (lb in)	81.2 (719)	110 (974)								
	n _{trans}	rpm	2358	2075								
DRS132M4	M _{max}	Nm (lb in)	82.5 (730)	110 (974)								
	n _{trans}	rpm	2646	2485								
DRS132MC4	M _{max}	Nm (lb in)	78.4 (694)	114 (1009)	150 (1333)	184 (1629)	200 (1770)					
	n _{trans}	rpm	2807	2636	2446	2270	2187					
DRS160S4	M _{max}	Nm (lb in)	80.4 (712)	118 (1044)	156 (1381)	190 (1682)	200 (1770)					
	n _{trans}	rpm	2443	2311	2162	2025	2017					
DRS160M4	M _{max}	Nm (lb in)	78.5 (695)	115 (1018)	152 (1345)	185 (1637)	200 (1770)					
	n _{trans}	rpm	2799	2654	2496	2346	2293					
DRS160MC4	M _{max}	Nm (lb in)		108 (956)	144 (1275)	176 (1558)	200 (1770)	200 (1770)				
	n _{trans}	rpm		2913	2821	2724	2772	2948				
DRS180S4	M _{max}	Nm (lb in)		114 (1009)	151 (1336)	185 (1637)	200 (1770)					
	n _{trans}	rpm		2629	2516	2400	2453					
DRS180M4	M _{max}	Nm (lb in)			157 (1390)	194 (1717)	240 (2124)	285 (2522)	355 (3142)	400 (3540)		
	n _{trans}	rpm			2463	2393	2304	2211	2058	1959		
DRS180L4	M _{max}	Nm (lb in)			155 (1372)	193 (1708)	239 (2115)	284 (2514)	355 (3142)	400 (3540)		
	n _{trans}	rpm			2589	2540	2470	2397	2274	2257		
DRS180LC4	M _{max}	Nm (lb in)				185 (1637)	229 (2027)	273 (2416)	341 (3018)	450 (3983)	530 (4691)	600 (5310)
	n _{trans}	rpm				2686	2623	2553	2433	2237	2088	1965
DRS200L4	M _{max}	Nm (lb in)					217 (1921)	258 (2283)	323 (2859)	425 (3762)	501 (4434)	600 (5310)
	n _{trans}	rpm					2680	2601	2469	2252	2091	1898
DRS225S4	M _{max}	Nm (lb in)						263 (2328)	331 (2930)	439 (3885)	519 (4594)	600 (5310)
	n _{trans}	rpm						2751	2654	2490	2361	2229
DRS225M4	M _{max}	Nm (lb in)							335 (2965)	443 (3921)	523 (4629)	600 (5310)
	n _{trans}	rpm							2645	2502	2387	2279
DRS225MC4	M _{max}	Nm (lb in)							329 (2912)	437 (3868)	516 (4567)	649 (5744)
	n _{trans}	rpm							2912	2759	2639	2437

Note:

The data is based on a supply voltage of AC 460 V.



DRS motor selection in double-star connection type (AC 230 V / 60 Hz)

Motors AC 230/460 V / 60 Hz in double-star connection:

Motor		MOVIDRIVE® MDX61B...-2_3 (AC 230 V units) in CFC operating modes (P700)								
AC 230 V / 60 Hz		0015	0022	0037	0055	0075	0110	0150	0220	0300
DRS71S4	M _{max} Nm (lb in)	10 (88.5)								
	n _{trans} rpm	439								
DRS71M4	M _{max} Nm (lb in)	10 (88.5)								
	n _{trans} rpm	820								
DRS80S4	M _{max} Nm (lb in)	14 (124)								
	n _{trans} rpm	960								
DRS80M4	M _{max} Nm (lb in)	14 (124)								
	n _{trans} rpm	1248								
DRS90M4	M _{max} Nm (lb in)	17.6 (156)	21 (186)	28 (248)						
	n _{trans} rpm	1084	1002	837						
DRS90L4	M _{max} Nm (lb in)	18.1 (160)	22.1 (196)	39 (345)	40 (354)					
	n _{trans} rpm	1160	1107	878	873					
DRS100M4 (3.7 kW)	M _{max} Nm (lb in)			35.7 (316)	40 (354)					
	n _{trans} rpm			1300	1371					
DRS100L4	M _{max} Nm (lb in)			36.4 (322)	40 (354)					
	n _{trans} rpm			1166	1359					
DRS112M4	M _{max} Nm (lb in)			36.3 (321)	55 (487)					
	n _{trans} rpm			1328	1162					
DRS132S4	M _{max} Nm (lb in)			35.4 (313)	55.2 (489)	73.5 (651)	107 (947)	110 (974)		
	n _{trans} rpm			1342	1235	1127	932	918		
DRS132M4	M _{max} Nm (lb in)				55.8 (494)	74.6 (660)	109 (965)	110 (974)		
	n _{trans} rpm				1362	1284	1132	1142		
DRS132MC4	M _{max} Nm (lb in)					70.5 (624)	104 (921)	135 (1195)	200 (1770)	
	n _{trans} rpm					1372	1279	1181	986	
DRS160S4	M _{max} Nm (lb in)					72.1 (638)	107 (947)	139 (1230)	200 (1770)	
	n _{trans} rpm					1190	1111	1037	892	
DRS160M4	M _{max} Nm (lb in)					70.4 (623)	105 (929)	136 (1204)	200 (1770)	
	n _{trans} rpm					1375	1296	1217	1054	
DRS160MC4	M _{max} Nm (lb in)						98.3 (870)	128 (1133)	194 (1717)	200 (1770)
	n _{trans} rpm						1432	1384	1270	1344

Note:
The data is based on a supply voltage of AC 230 V.



Motor Selection

Motor selection for asynchronous servomotors (CFC)

Motor			MOVIDRIVE® MDX61B...-2_3 (AC 230 V units) in CFC operating modes (P700)								
AC 230 V / 60 Hz			0015	0022	0037	0055	0075	0110	0150	0220	0300
DRS180S4	M_{max}	Nm (lb in)						103 (912)	135 (1195)	200 (1770)	200 (1770)
	n_{trans}	rpm						1291	1235	1118	1145
DRS180M4	M_{max}	Nm (lb in)							139 (1230)	214 (1894)	257 (2275)
	n_{trans}	rpm							1215	1132	1082
DRS180L4	M_{max}	Nm (lb in)								213 (1885)	256 (2266)
	n_{trans}	rpm								1215	1175
DRS180LC4	M_{max}	Nm (lb in)								205 (1814)	246 (2177)
	n_{trans}	rpm								1298	1261
DRS200L4	M_{max}	Nm (lb in)								193 (1708)	232 (2053)
	n_{trans}	rpm								1335	1297
DRS225S4	M_{max}	Nm (lb in)									236 (2089)
	n_{trans}	rpm									1371



Motor table for DRE series AC motors

Characteristic values for double-star/star AC 230/460 V / 60 Hz

Motor	M _N Nm (lb in)	Mass moment of inertia J _M 10 ⁻⁴ kgm ²		Star (AC 460 V)				Double-star (AC 230 V)			
		Without brake	With brake	I _n A	I _{q_n} ¹⁾ A	I _{d_n} ¹⁾ A	k _T ¹⁾ Nm/A (lb in/A)	I _n A	I _{q_n} ¹⁾ A	I _{d_n} ¹⁾ A	k _T ¹⁾ Nm/A (lb in/A)
DRE80M4	4.1 (36)	21.5	23	1.44	1.15	0.86	3.56 (31.5)	2.88	2.31	1.73	1.78 (15.8)
DRE90M4	6.0 (53)	35.5	40	2.30	1.83	1.39	3.27 (28.9)	4.60	3.67	2.77	1.63 (14.4)
DRE90L4	8.2 (73)	43.5	48.5	2.80	2.14	1.80	3.83 (33.9)	5.60	4.28	3.61	1.91 (16.9)
DRE100L4	12.1 (107)	68	74	4.00	3.39	2.12	3.57 (31.6)	8.0	6.8	4.25	1.78 (15.8)
DRE100LC4	20 (179)	89.8	95.8	6.40	5.85	2.60	3.42 (30.3)	12.8	11.7	5.20	1.71 (15.1)
DRE112M4	20 (179)	146	151	6.30	5.96	2.04	3.35 (29.6)	12.6	11.9	4.07	1.68 (14.9)
DRE132M4	30 (265)	255	265	9.00	8.57	2.74	3.50 (31.0)	18.0	17.1	5.49	1.75 (15.5)
DRE132MC4	40.5 (358)	340	355	12.9	11.5	5.93	3.54 (31.4)	25.8	22.9	11.9	1.77 (15.7)
DRE160S4	40.5 (358)	370	390	12.7	11.4	5.66	3.56 (31.5)	25.4	22.7	11.3	1.78 (15.8)
DRE160M4	49.5 (439)	450	500	15.4	14.0	6.52	3.55 (31.5)	30.8	27.9	13.0	1.77 (15.7)
DRE160MC4	59 (522)	590	640	18.3	16.8	7.28	3.51 (31.1)	36.6	33.6	14.6	1.76 (15.6)
DRE180S4	59 (522)	900	960	17.9	16.3	7.36	3.62 (32.0)	35.8	32.6	14.7	1.81 (16.0)
DRE180M4	81 (716)	1110	1170	24.0	22.1	8.86	3.67 (32.5)	48.0	44.2	17.7	1.83 (16.2)
DRE180L4	100 (885)	1300	1440	30.0	27.0	12.7	3.71 (32.9)	60.0	54.0	25.3	1.85 (16.4)
DRE180LC4	118 (1044)	1790	1930	35.5	33.2	12.6	3.56 (31.5)	71.0	66.4	25.2	1.78 (15.8)
DRE200L4	161 (1425)	2360	2500	49.5	45.4	19.0	3.54 (31.3)	99.0	90.9	38.0	1.77 (15.7)
DRE225S4	199 (1762)	2930	3160	59.0	57.2	15.1	3.48 (30.8)	118	114	30.3	1.74 (15.4)
DRE225M4	240 (2131)	3430	3660	71.0	66.5	24.4	3.61 (31.9)	142	133	48.7	1.80 (15.9)
DRE315K4	590 (5215)	18400	19500	169	157	63.2	3.76 (33.3)	338	314	126	1.88 (16.6)
DRE315S4	800 (7090)	22500	23600	225	207	89.8	4.34 (38.4)	450	415	180	2.17 (19.2)
DRE315M4	990 (8762)	27900	29000	275	264	81.0	3.75 (33.2)	550	528	162	1.87 (16.6)

1) Applies in the basic speed range up to n_{trans}.



Motor Selection

Motor selection for asynchronous servomotors (CFC)

DRE motor selection in double-star/star connection type (AC 230/400 V / 60 Hz)

1. Motors AC 230/460 V / 60 Hz in star connection

Assignment of MOVIDRIVE® MDX61B0005-5A3 ... MDX61B0110-503 (sizes 0 ... 2):

Motor		MOVIDRIVE® MDX61B...-5_3 (AC 400/500 V units) in CFC operating modes (P700)											
AC 460 V / 60 Hz		0005	0008	0011	0014	0015	0022	0030	0040	0055	0075	0110	
DRE80M4	M _{max}	Nm (lb in)	13.9 (123)	14 (124)			14 (124)						
	n _{trans}	rpm	949	978			978						
DRE90M4	M _{max}	Nm (lb in)	12.3 (109)	14 (124)	14 (124)		14 (124)						
	n _{trans}	rpm	1195	1212	1324		1318						
DRE90L4	M _{max}	Nm (lb in)		17.1 (151)	22.8 (202)	28 (248)	22 (195)	28 (248)					
	n _{trans}	rpm		1119	1031	972	1043	978					
DRE100L4	M _{max}	Nm (lb in)				27.6 (244)	20 (177)	28.5 (252)	36.7 (325)	40 (354)			
	n _{trans}	rpm				1095	1177	1084	990	972			
DRE100LC4	M _{max}	Nm (lb in)						27 (239)	35.1 (311)	40 (354)	40 (354)		
	n _{trans}	rpm						1353	1289	1394	1470		
DRE112M4	M _{max}	Nm (lb in)						27.1 (240)	34.9 (309)	40 (354)			
	n _{trans}	rpm						1503	1425	1464			
DRE132M4	M _{max}	Nm (lb in)							35.4 (313)	48.8 (432)	64.8 (574)	83.2 (736)	110 (974)
	n _{trans}	rpm							1538	1455	1352	1225	1044
DRE132MC4	M _{max}	Nm (lb in)									62.7 (555)	81.9 (725)	110 (974)
	n _{trans}	rpm									1313	1259	1250
DRE160S4	M _{max}	Nm (lb in)									63.6 (563)	83 (735)	110 (974)
	n _{trans}	rpm									1217	1168	1168
DRE160M4	M _{max}	Nm (lb in)									62.5 (553)	82.2 (728)	126 (1115)
	n _{trans}	rpm									1296	1252	1147
DRE160MC4	M _{max}	Nm (lb in)										80.4 (712)	123 (1089)
	n _{trans}	rpm										1362	1283
DRE180S4	M _{max}	Nm (lb in)										83.1 (735)	128 (1133)
	n _{trans}	rpm										1321	1221
DRE180M4	M _{max}	Nm (lb in)											127 (1124)
	n _{trans}	rpm											1265
DRE180L4	M _{max}	Nm (lb in)											124 (1097)
	n _{trans}	rpm											1324

Note:

The data is based on a supply voltage of AC 460 V.



Assignment of MOVIDRIVE® MDX61B0150-503 ... MDX61B1320-503 (sizes 3 ... 6):

Motor		MOVIDRIVE® MDX61B...-5_3 (AC 400/500 V units) in CFC operating modes (P700)										
		AC 460 V / 60 Hz	0150	0220	0300	0370	0450	0550	0750	0900	1100	1320
DRE160S4	M _{max}	Nm (lb in)	110 (974)									
	n _{trans}	rpm	1204									
DRE160M4	M _{max}	Nm (lb in)	169 (1496)	200 (1770)								
	n _{trans}	rpm	1028	949								
DRE160MC4	M _{max}	Nm (lb in)	166 (1469)	200 (1770)								
	n _{trans}	rpm	1199	1164								
DRE180S4	M _{max}	Nm (lb in)	172 (1522)	200 (1770)								
	n _{trans}	rpm	1115	1052								
DRE180M4	M _{max}	Nm (lb in)	172 (1522)	200 (1770)								
	n _{trans}	rpm	1192	1211								
DRE180L4	M _{max}	Nm (lb in)	170 (1505)	250 (2213)	328 (2903)	400 (3540)						
	n _{trans}	rpm	1275	1178	1079	982						
DRE180LC4	M _{max}	Nm (lb in)	164 (1452)	241 (2133)	316 (2797)	386 (3416)	400 (3540)					
	n _{trans}	rpm	1311	1221	1125	1035	1018					
DRE200L4	M _{max}	Nm (lb in)		234 (2071)	311 (2753)	381 (3372)	468 (4142)	552 (4886)	600 (5310)			
	n _{trans}	rpm		1259	1186	1113	1025	940	896			
DRE225S4	M _{max}	Nm (lb in)		234 (2071)	308 (2726)	377 (3337)	460 (4071)	544 (4815)	600 (5310)			
	n _{trans}	rpm		1438	1353	1268	1166	1069	1007			
DRE225M4	M _{max}	Nm (lb in)			314 (2779)	387 (3425)	476 (4213)	564 (4992)	600 (5310)			
	n _{trans}	rpm			1242	1198	1142	1081	1084			
DRE315K4	M _{max}	Nm (lb in)						692 (6125)	926 (8196)	1100 (9736)	1386 (12267)	
	n _{trans}	rpm						1294	1272	1254	1223	
DRE315S4	M _{max}	Nm (lb in)								1106 (9789)	1407 (12453)	
	n _{trans}	rpm								1259	1239	
DRE315M4	M _{max}	Nm (lb in)										1373 (12152)
	n _{trans}	rpm										1239

Note:
The data is based on a supply voltage of AC 460 V.



Motor Selection

Motor selection for asynchronous servomotors (CFC)

2. Motors AC 230/460 V / 60 Hz in double-star connection:

Assignment of **MOVIDRIVE® MDX61B0008-5A3 ... MDX61B0110-503 (sizes 0 ... 2)**:

Motor		MOVIDRIVE® MDX61B...-5_3 (AC 400/500 V units) in CFC operating modes (P700)										
AC 230 V / 60 Hz		0005	0008	0011	0014	0015	0022	0030	0040	0055	0075	0110
DRE80M4	M _{max} Nm (lb in)		8 (71)	10.6 (94)	13.9 (123)	10.3 (91)	14 (124)	14 (124)				
	n _{trans} rpm		2554	2437	2279	2455	2308	2507				
DRE90M4	M _{max} Nm (lb in)				12.3 (109)	8.8 (78)	12.8 (113)	14 (124)	14 (124)			
	n _{trans} rpm				2595	2707	2578	2847	3093			
DRE90L4	M _{max} Nm (lb in)						14.3 (127)	18.9 (167)	26.5 (235)	28 (248)		
	n _{trans} rpm						2484	2395	2238	2425		
DRE100L4	M _{max} Nm (lb in)							17.2 (152)	24.3 (215)	32.8 (290)	40 (354)	40 (354)
	n _{trans} rpm							2548	2443	2314	2244	2320
DRE100LC4	M _{max} Nm (lb in)									31.1 (275)	40 (354)	40 (354)
	n _{trans} rpm									2794	2724	3275
DRE112M4	M _{max} Nm (lb in)								23.1 (204)	31 (274)	40 (354)	40 (354)
	n _{trans} rpm								3193	3071	2915	3173
DRE132M4	M _{max} Nm (lb in)										40.8 (361)	62.1 (550)
	n _{trans} rpm										3115	2885
DRE132MC4	M _{max} Nm (lb in)											59.9 (530)
	n _{trans} rpm											2719
DRE160S4	M _{max} Nm (lb in)											60.8 (538)
	n _{trans} rpm											2531
DRE160M4	M _{max} Nm (lb in)											59.7 (528)
	n _{trans} rpm											2671

Note:

The data is based on a supply voltage of AC 460 V.



Assignment of MOVIDRIVE® MDX61B0150-503 ... MDX61B1320-503 (sizes 3 ... 6):

Motor			MOVIDRIVE® MDX61B...-5_3 (AC 400/500 V units) in CFC operating modes (P700)									
AC 230 V / 60 Hz			0150	0220	0300	0370	0450	0550	0750	0900	1100	1320
DRE132M4	M_{max}	Nm (lb in)	82.2 (728)	110 (974)								
	n_{trans}	rpm	2631	2314								
DRE132MC4	M_{max}	Nm (lb in)	81.9 (725)	110 (974)	110 (974)							
	n_{trans}	rpm	2622	2617	2788							
DRE160S4	M_{max}	Nm (lb in)	83 (735)	110 (974)	110 (974)							
	n_{trans}	rpm	2443	2460	2614							
DRE160M4	M_{max}	Nm (lb in)	82.2 (728)	120 (1062)	158 (1398)	193 (1708)	200 (1770)					
	n_{trans}	rpm	2597	2439	2267	2109	2074					
DRE160MC4	M_{max}	Nm (lb in)	80.4 (712)	118 (1044)	156 (1381)	190 (1682)	200 (1770)					
	n_{trans}	rpm	2794	2685	2562	2434	2526					
DRE180S4	M_{max}	Nm (lb in)	83.1 (735)	122 (1080)	161 (1425)	197 (1744)	200 (1770)					
	n_{trans}	rpm	2716	2573	2410	2257	2257					
DRE180M4	M_{max}	Nm (lb in)		121 (1071)	161 (1425)	197 (1744)	200 (1770)					
	n_{trans}	rpm		2616	2510	2400	2560					
DRE180L4	M_{max}	Nm (lb in)		118 (1044)	159 (1407)	196 (1735)	241 (2133)	286 (2531)	356 (3151)	400 (3540)		
	n_{trans}	rpm		2712	2646	2573	2477	2374	2211	2108		
DRE180HC4	M_{max}	Nm (lb in)			153 (1354)	189 (1673)	233 (2062)	276 (2443)	343 (3036)	400 (3540)		
	n_{trans}	rpm			2699	2629	2536	2433	2274	2138		
DRE200L4	M_{max}	Nm (lb in)					226 (2000)	270 (2390)	338 (2992)	446 (3947)	526 (4655)	600 (5310)
	n_{trans}	rpm					2584	2510	2387	2182	2033	1898
DRE225S4	M_{max}	Nm (lb in)					225 (1991)	268 (2372)	334 (2956)	439 (3885)	518 (4585)	600 (5310)
	n_{trans}	rpm					2944	2856	2710	2466	2291	2118
DRE225M4	M_{max}	Nm (lb in)							342 (3027)	454 (4018)	537 (4753)	600 (5310)
	n_{trans}	rpm							2502	2376	2276	2261

Note:
The data is based on a supply voltage of AC 460 V.



Motor Selection

Motor selection for asynchronous servomotors (CFC)

DRE motor selection in double-star connection type (AC 230 V / 60 Hz)

Motors AC 230/460 V / 60 Hz in double-star connection:

Motor			MOVIDRIVE® MDX61B...-2_3 (AC 230 V units) in CFC operating modes (P700)								
AC 230 V / 60 Hz			0015	0022	0037	0055	0075	0110	0150	0220	0300
DRE80M4	M _{max}	Nm (lb in)	14 (124)								
	n _{trans}	rpm	978								
DRE90M4	M _{max}	Nm (lb in)	14 (124)								
	n _{trans}	rpm	1289								
DRE90L4	M _{max}	Nm (lb in)	19.9 (176)	23.8 (211)	28 (248)						
	n _{trans}	rpm	1078	1013	990						
DRE100L4	M _{max}	Nm (lb in)	18 (159)	21.8 (193)	38.1 (337)	40 (354)					
	n _{trans}	rpm	1201	1160	972	972					
DRE100LC4	M _{max}	Nm (lb in)			36.5 (323)	40 (354)					
	n _{trans}	rpm			1283	1464					
DRE112M4	M _{max}	Nm (lb in)			36.2 (320)	40 (354)					
	n _{trans}	rpm			1411	1469					
DRE132M4	M _{max}	Nm (lb in)			36.7 (325)	56.8 (503)	75.3 (666)	109 (965)	110 (974)		
	n _{trans}	rpm			1533	1406	1279	1049	1044		
DRE132MC4	M _{max}	Nm (lb in)				54.2 (480)	73.7 (652)	109 (965)	110 (974)		
	n _{trans}	rpm				1333	1279	1176	1279		
DRE160S4	M _{max}	Nm (lb in)				55.2 (489)	74.8 (662)	110 (974)	110 (974)		
	n _{trans}	rpm				1239	1186	1094	1190		
DRE160M4	M _{max}	Nm (lb in)					73.8 (653)	109 (965)	142 (1257)	200 (1770)	
	n _{trans}	rpm					1274	1186	1103	949	
DRE160MC4	M _{max}	Nm (lb in)					72 (637)	107 (947)	140 (1239)	200 (1770)	
	n _{trans}	rpm					1379	1314	1252	1147	
DRE180S4 (11 kW)	M _{max}	Nm (lb in)					74.4 (658)	111 (982)	144 (1275)	200 (1770)	
	n _{trans}	rpm					1338	1261	1182	1052	
DRE180S4 (15 kW)	M _{max}	Nm (lb in)						107 (947)	141 (1248)	200 (1770)	
	n _{trans}	rpm						1291	1235	1152	
DRE180M4 (18.5 kW)	M _{max}	Nm (lb in)							142 (1257)	200 (1770)	200 (1770)
	n _{trans}	rpm							1334	1308	1404
DRE180L4 (18.5 kW)	M _{max}	Nm (lb in)							143 (1266)	220 (1947)	264 (2337)
	n _{trans}	rpm							1231	1155	1109
DRE180LC4 (22 kW)	M _{max}	Nm (lb in)								213 (1885)	256 (2266)
	n _{trans}	rpm								1205	1162
DRE180LC4 (30 kW)	M _{max}	Nm (lb in)								207 (1832)	249 (2204)
	n _{trans}	rpm								1258	1225
DRE200L4	M _{max}	Nm (lb in)								201 (1779)	243 (2151)
	n _{trans}	rpm								1289	1251
DRE225S4	M _{max}	Nm (lb in)									243 (2151)
	n _{trans}	rpm									1338

Note:
The data is based on a supply voltage of AC 230 V.



3.4 Motor selection for synchronous servomotors (SERVO)

	NOTE
	<p>The torque limit (M limit) is set automatically by the startup function of the MOVITOOLS[®] operating software. Do not increase this automatically set value!</p> <p>We recommend always using the latest version of MOVITOOLS[®] for startup. The latest MOVITOOLS[®] version can be downloaded from our homepage (www.sew-eurodrive.com).</p>

Motor characteristics

The requirements on a servo drive include speed dynamics, stable speed and positioning accuracy. DS/CM/CMD/CMP motors with MOVIDRIVE[®] meet these requirements.

Technically speaking, these are synchronous motors with permanent magnets on the rotor and a mounted resolver. The required characteristics, namely a constant torque over a wide speed range (up to 6000 rpm), a high speed and control range and a high overload capacity, are achieved using control with MOVIDRIVE[®]. The mass moment of inertia of the servomotor is lower than that of the asynchronous motor. This means it is optimally suited to applications requiring dynamic speeds.

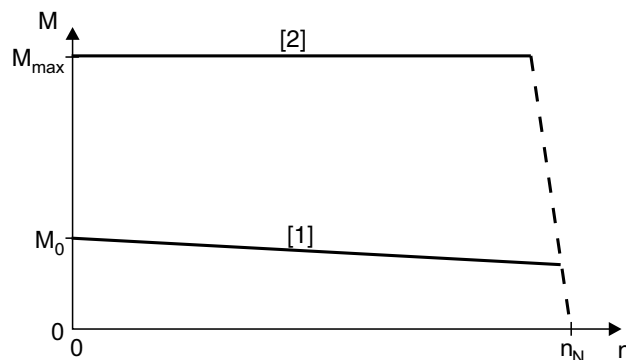

Figure 4: Speed/torque characteristic curve of DS/CM/CMD/CMP servomotors

63221AXX

- [1] Continuous torque
- [2] Maximum torque

M_0 and M_{max} are determined by the motor. The attainable M_{max} can also be less, depending on the inverter.

Refer to the motor selection tables (DS/CM/CMD/CMP) the values for M_0 .

Refer to the motor selection tables (DS/CM/CMD/CMP) for the values for M_{max} .



Motor Selection

Motor selection for synchronous servomotors (SERVO)

Basic recommendations

The necessary motor data for the SERVO operating modes are stored in MOVIDRIVE® for the SEW motors.

Speed is the correcting variable in the SERVO operating modes with speed control. Torque is the correcting variable in the SERVO operating modes with torque control (SERVO & M-CONTROL).

SERVO mode with speed control

There is no need to differentiate between the load types quadratic, dynamic and static when performing project planning for the SERVO operating mode. Project planning for a synchronous motor is carried out in accordance with the following requirements:

1. Effective torque requirement at average application speed.

$$M_{\text{eff}} < M_0$$

The operating point must lie below the characteristic curve for the continuous torque (Figure 4, curve 1). The continuous torque of the CM series can be increased by 40 % by forced cooling if this operating point lies above the characteristic curve for self-cooling.

2. Maximum torque needed across the speed curve.

$$M_{\text{max}} < M_{\text{dyn_mot}}$$

This operating point must lie below the characteristic curve for the maximum torque of the motor/MOVIDRIVE® combination (Figure 4, curve 2).

SERVO mode with torque control (SERVO & M-CTRL.)

This operating mode enables the servomotor to be controlled directly with torque control. The setpoint sources of the speed controlled SERVO mode can also be used for torque control. All speed setpoint sources (except for bus setpoints) are interpreted as current setpoint sources. Assign "Current" to a process data word for fieldbus control. The settings for evaluating the analog input (→ P11_, parameter description) also remain in effect. The fixed setpoints (P16_, P17_) can be entered either in the unit (rpm) or (%I_{N_inverter}) (→ MOVITOOLS®).

The following relationship exists between the units:

$$3000 \text{ rpm} = 150 \% \text{ rated inverter current}$$

The torque at the output shaft of the servomotor can be calculated using the following formula:

$$M = \frac{M_0}{I_0} \times \frac{150 \% \times I_{n_inverter} \times n_{setp}}{3000 \text{ 1/min}}$$

04976AEN

M_0 Continuous static torque according to the motor tables DS/CM/CMD/CMP

I_0 Continuous standstill current according to the motor tables DS/CM/CMD/CMP



CMP motor table

Characteristic values with AC 400 V system voltage

n _N rpm	Motor	Without forced cooling fan		With forced cooling fan		I _{max} A	Mass moment of inertia J _M		
		M ₀	I ₀	M _{0_VR}	I _{0_VR}		Without brake	With brake	with additional inertia
		Nm (lb in)	A	Nm (lb in)	A				
3000	CMP40S	0.5 (4)	1.2	-	-	6.1	0.104	0.132	-
	CMP40M	0.8 (7)	0.95	-	-	6.0	0.148	0.176	-
	CMP50S	1.3 (12)	0.96	1.7 (15)	1.25	5.1	0.415	0.481	-
	CMP50M	2.4 (21)	1.68	3.5 (31)	2.45	9.6	0.667	0.733	-
	CMP50L	3.3 (29)	2.2	4.8 (42)	3.2	13.6	0.919	0.985	-
	CMP63S	2.9 (26)	2.15	4 (35)	3	12.9	1.15	1.49	-
	CMP63M	5.3 (47)	3.6	7.5 (66)	5.1	21.6	1.92	2.26	-
	CMP63L	7.1 (63)	4.95	10.3 (91.2)	7.2	29.7	2.69	3.03	-
	CMP71S	6.4 (57)	4.9	8.1 (72)	6.2	25	3.01	3.45	11.1
	CMP71M	9.4 (83)	7.5	11.6 (103)	9.3	39	4.06	4.5	12.2
	CMP71L	13.1 (116)	9.4	18.1 (160)	13	58	6.16	6.6	14.3
	CMP80S	13.4 (119)	15.3	16.8 (149)	12.5	47	8.39	9.79	30.7
	CMP80M	18.7 (166)	13.4	24.7 (219)	17.7	69	11.5	12.9	33.9
	CMP80L	27.3 (242)	18.6	37.7 (334)	25.7	107	17.7	19.1	40.1
	CMP100S	25.6 (227)	19.6	32 (283)	24.5	73	19.3	22.2	85.1
	CMP100M	31.1 (275)	22	42 (372)	29.5	102	26.3	29.1	92
CMP100L	47 (416)	32.3	65 (575)	44.7	167	40	42.8	106	
4500	CMP40S	0.5 (4)	1.2	-	-	6.1	0.104	0.132	-
	CMP40M	0.8 (7)	0.95	-	-	6	0.148	0.176	-
	CMP50S	1.3 (12)	1.32	1.7 (15)	1.7	7	0.415	0.481	-
	CMP50M	2.4 (21)	2.3	3.5 (31)	3.35	13.1	0.667	0.733	-
	CMP50L	3.3 (29)	3.15	4.8 (42)	4.6	19.5	0.919	0.985	-
	CMP63S	2.9 (26)	3.05	4 (35)	4.2	18.3	1.15	1.49	-
	CMP63M	5.3 (47)	5.4	7.5 (66)	7.6	32.4	1.92	2.26	-
	CMP63L	7.1 (63)	6.9	10.3 (91.2)	10	41.4	2.69	3.03	-
	CMP71S	6.4 (57)	7.3	8.1 (72)	9.2	38	3.01	3.45	11.1
	CMP71M	9.4 (83)	10.9	11.6 (103)	13.5	57	4.06	4.5	12.2
	CMP71L	13.1 (116)	14.1	18.1 (160)	19.5	87	6.16	6.6	14.3
	CMP80S	13.4 (119)	15.3	16.8 (149)	19.2	73	8.39	9.79	30.7
	CMP80M	18.7 (166)	20.1	24.7 (219)	26.5	103	11.5	12.9	33.9
	CMP80L	27.3 (242)	27.6	37.7 (334)	38.1	159	17.7	19.1	40.1
	CMP100S	25.6 (227)	29.9	32 (283)	37.4	111	19.3	22.2	85.1
	CMP100M	31.3 (277)	33.4	42 (372)	44.8	154	26.3	29.1	92
CMP100L	47 (416)	48.4	65 (575)	66.9	251	40	42.8	106	
6000	CMP40S	0.5 (4)	1.2	-	-	6.1	0.104	0.132	-
	CMP40M	0.8 (7)	1.1	-	-	6.9	0.148	0.176	-
	CMP50S	1.3 (12)	1.7	1.7 (15)	2.2	9	0.415	0.481	-
	CMP50M	2.4 (21)	3	3.5 (31)	4.4	17.1	0.667	0.733	-
	CMP50L	3.3 (29)	4.2	4.8 (42)	6.1	26	0.919	0.985	-
	CMP63S	2.9 (26)	3.9	4 (35)	5.4	23.4	1.15	1.49	-
	CMP63M	5.3 (47)	6.9	7.5 (66)	9.8	41.4	1.92	2.26	-
	CMP63L	7.1 (63)	9.3	10.3 (91.2)	13.5	55.8	2.69	3.03	-
	CMP71S	6.4 (57)	9.6	8.1 (72)	12.2	50	3.01	3.45	11.1
	CMP71M	9.4 (83)	14.7	11.6 (103)	18.1	76	4.06	4.5	12.2
	CMP71L	13.1 (116)	18.8	18.1 (160)	26	115	6.16	6.6	14.3
	CMP80S	13.4 (119)	20	16.8 (149)	25.1	95	8.39	9.79	30.7
	CMP80M	18.7 (166)	26.4	24.7 (219)	34.9	135	11.5	12.9	33.9
	CMP80L	27.3 (242)	37.3	37.7 (334)	51.5	215	17.7	19.1	40.1



Motor Selection

Motor selection for synchronous servomotors (SERVO)

CMP motor selection (AC 400 V system voltage)

1. Rated speed $n_N = 3000$ rpm:

Assignment **MOVIDRIVE® MDX61B0005-5_3 - MDX61B0110-5_3** (sizes 0 - 2):

Motor		MOVIDRIVE® MDX61B...-5_3 (AC 400 V units) in SERVO operating modes (P700)										
		0005	0008	0011	0014	0015	0022	0030	0040	0055	0075	0110
CMP40S	M_{max} Nm (lb in)	1.5 (13)	1.7 (15)	1.9 (17)		1.9 (17)	1.9 (17)					
CMP40M	M_{max} Nm (lb in)	3.0 (27)	3.3 (29)	3.8 (34)		3.8 (3.4)						
CMP50S	M_{max} Nm (lb in)	4.5 (40)	5.0 (44)	5.2 (46)		5.2 (46)						
CMP50M	M_{max} Nm (lb in)	5.4 (48)	6.3 (56)	7.7 (68)	9.3 (82)	7.6 (67)	9.4 (83)	10.3 (91)				
CMP50L	M_{max} Nm (lb in)	5.9 (52)	6.9 (61)	8.7 (77)	10.7 (95)	8.4 (74)	11.0 (97)	13.1 (116)	15.4 (136)			
CMP63S	M_{max} Nm (lb in)	5.2 (46)	6.0 (53)	7.3 (65)	8.7 (77)	7.1 (63)	8.8 (78)	10.1 (89)	11.1 (98)			
CMP63M	M_{max} Nm (lb in)	6.0 (53)	7.1 (63)	8.9 (79)	11.1 (98)	8.7 (77)	11.3 (100)	13.7 (121)	17.0 (150)	20.0 (177)	21.4 (189)	
CMP63L	M_{max} Nm (lb in)			9.0 (80)	11.3 (100)	8.7 (77)	11.6 (103)	14.4 (127)	18.6 (165)	23.0 (204)	27.0 (239)	30.4 (269)
CMP71S	M_{max} Nm (lb in)			8.1 (72)	10.1 (89)	7.9 (70)	10.4 (92)	12.6 (112)	15.5 (137)	17.7 (157)	19.0 (168)	19.2 (170)
CMP71M	M_{max} Nm (lb in)				10.0 (89)	7.6 (67)	10.3 (91)	12.9 (114)	16.9 (150)	21.0 (186)	24.7 (219)	29.6 (262)
CMP71L	M_{max} Nm (lb in)						11.4 (101)	14.5 (128)	19.5 (173)	25.1 (222)	30.9 (273)	40.4 (358)
CMP80S	M_{max} Nm (lb in)								12.3 (109)	16.2 (143)	20.7 (183)	29.4 (260)
CMP80M	M_{max} Nm (lb in)							14.7 (130)	19.9 (176)	26.0 (230)	32.6 (289)	45.3 (401)
CMP80L	M_{max} Nm (lb in)								20.8 (184)	27.3 (242)	34.6 (306)	50.5 (447)
CMP100S	M_{max} Nm (lb in)									24.6 (218)	31.1 (275)	44.6 (395)
CMP100M	M_{max} Nm (lb in)									26.6 (235)	34.0 (301)	50.5 (447)
CMP100L	M_{max} Nm (lb in)											52.7 (466)

Assignment **MOVIDRIVE® MDX61B0150-5_3 - MDX61B1320-5_3** (sizes 3 - 6):

Motor		MOVIDRIVE® MDX61B...-5_3 (AC 400 V units) in SERVO operating modes (P700)										
		0150	0220	0300	0370	0450	0550	0750	0900	1100	1320	
CMP71M	M_{max} Nm (lb in)	30.8 (273)										
CMP71L	M_{max} Nm (lb in)	44.8 (397)	46.9 (415)									
CMP80S	M_{max} Nm (lb in)	42.1 (373)										
CMP80M	M_{max} Nm (lb in)	54.1 (479)	62.6 (554)									
CMP80L	M_{max} Nm (lb in)	64.9 (574)	85.0 (752)	98.8 (874)	107 (946)							
CMP100S	M_{max} Nm (lb in)	55.2 (489)	66.8 (591)	68.3 (605)								
CMP100M	M_{max} Nm (lb in)	65.4 (579)	86.7 (767)	101 (894)	108 (958)							
CMP100L	M_{max} Nm (lb in)	69.7 (617)	97.5 (863)	122 (1080)	141 (1244)	159 (1405)	173 (1533)	179 (1583)				



2. Rated speed $n_N = 4500$ rpm:

Assignment **MOVIDRIVE® MDX61B0005-5_3 - MDX61B0110-5_3** (sizes 0 - 2):

Motor		MOVIDRIVE® MDX61B...-5_3 (AC 400 V units) in SERVO operating modes (P700)										
		0005	0008	0011	0014	0015	0022	0030	0040	0055	0075	0110
CMP40S	M_{max} Nm (lb in)	1.5 (13)	1.7 (15)	1.9 (17)		1.9 (17)	1.9 (17)					
CMP40M	M_{max} Nm (lb in)	3.0 (27)	3.3 (29)	3.8 (34)		3.8 (34)						
CMP50S	M_{max} Nm (lb in)	3.5 (31)	4.1 (36)	4.8 (42)	5.2 (46)	4.7 (42)	5.2 (46)					
CMP50M	M_{max} Nm (lb in)	4.1 (36)	4.8 (42)	6.0 (53)	7.4 (65)	5.9 (52)	7.6 (67)	9.0 (80)	10.3 (91)			
CMP50L	M_{max} Nm (lb in)	4.2 (37)	5.0 (44)	6.3 (56)	7.9 (70)	6.1 (54)	8.2 (73)	10.0 (89)	12.7 (112)	15.1 (134)	15.4 (136)	
CMP63S	M_{max} Nm (lb in)	3.8 (34)	4.5 (40)	5.6 (50)	6.8 (60)	5.4 (48)	7.0 (62)	8.2 (73)	9.9 (88)	11.1 (98)		
CMP63M	M_{max} Nm (lb in)			6.2 (55)	7.8 (69)	6.0 (53)	8.0 (71)	9.9 (88)	12.7 (112)	15.6 (138)	18.3 (162)	21.4 (189)
CMP63L	M_{max} Nm (lb in)				8.3 (73)	6.4 (57)	8.6 (76)	10.7 (95)	14.1 (125)	17.8 (158)	21.6 (191)	28.2 (250)
CMP71S	M_{max} Nm (lb in)				7.1 (63)	5.5 (49)	7.3 (65)	9.1 (81)	11.7 (104)	14.3 (127)	16.6 (147)	19.1 (169)
CMP71M	M_{max} Nm (lb in)						7.2 (64)	9.1 (81)	12.2 (108)	15.6 (138)	19.1 (169)	25.1 (222)
CMP71L	M_{max} Nm (lb in)								13.1 (116)	17.2 (152)	21.7 (192)	30.9 (273)
CMP80S	M_{max} Nm (lb in)								12.3 (109)	16.2 (143)	20.7 (183)	29.4 (260)
CMP80M	M_{max} Nm (lb in)									17.5 (155)	22.3 (197)	32.6 (289)
CMP80L	M_{max} Nm (lb in)										23.6 (209)	35.0 (310)
CMP100S	M_{max} Nm (lb in)										20.7 (183)	30.7 (272)
CMP100M	M_{max} Nm (lb in)											33.8 (299)

Assignment **MOVIDRIVE® MDX61B0150-5_3 - MDX61B1320-5_3** (sizes 3 - 6):

Motor		MOVIDRIVE® MDX61B...-5_3 (AC 400 V units) in SERVO operating modes (P700)										
		0150	0220	0300	0370	0450	0550	0750	0900	1100	1320	
CMP63L	M_{max} Nm (lb in)	30.4 (269)										
CMP71S	M_{max} Nm (lb in)	19.2 (170)										
CMP71M	M_{max} Nm (lb in)	28.6 (253)	30.8 (273)									
CMP71L	M_{max} Nm (lb in)	37.8 (335)	44.3 (392)	46.9 (415)								
CMP80S	M_{max} Nm (lb in)	35.4 (313)	41.0 (363)	42.1 (373)								
CMP80M	M_{max} Nm (lb in)	41.5 (367)	52.9 (468)	59.5 (527)	62.6 (554)							
CMP80L	M_{max} Nm (lb in)	45.8 (405)	63.2 (559)	77.8 (689)	88.7 (785)	98.8 (874)	106.3 (941)	106.9 (946)				
CMP100S	M_{max} Nm (lb in)	39.8 (352)	53.0 (469)	62.2 (551)	67.9 (601)	68.3 (605)						
CMP100M	M_{max} Nm (lb in)	44.9 (397)	62.8 (556)	78.2 (692)	89.8 (795)	100.6 (890)	108.1 (957)					
CMP100L	M_{max} Nm (lb in)	46.9 (415)	67.0 (593)	86.0 (761)	102.5 (907)	120.8 (1067)	136.6 (1209)	156.5 (1385)	178.8 (1583)			



Motor Selection

Motor selection for synchronous servomotors (SERVO)

3. Rated speed $n_N = 6000$ rpm:

Assignment **MOVIDRIVE® MDX61B0005-5_3 - MDX61B0110-5_3** (sizes 0 - 2):

Motor		MOVIDRIVE® MDX61B...-5_3 (AC 400 V units) in SERVO operating modes (P700)										
		0005	0008	0011	0014	0015	0022	0030	0040	0055	0075	0110
CMP40S	M_{max} Nm (lb in)	1.5 (13)	1.7 (15)	1.9 (17)		1.9 (17)	1.9 (17)					
CMP40M	M_{max} Nm (lb in)	2.6 (23)	3.0 (27)	3.6 (32)	3.8 (34)	3.5 (31)	3.8 (34)					
CMP50S	M_{max} Nm (lb in)	2.9 (26)	3.3 (29)	4.1 (36)	4.8 (42)	4.0 (35)	4.9 (43)	5.2 (46)				
CMP50M	M_{max} Nm (lb in)	3.2 (28)	3.8 (34)	4.8 (42)	6.0 (53)	4.6 (41)	6.1 (54)	7.4 (65)	9.2 (81)	10.3 (91)		
CMP50L	M_{max} Nm (lb in)		3.8 (34)	4.8 (42)	6.1 (54)	4.7 (42)	6.3 (56)	7.8 (69)	10.2 (90)	12.5 (111)	14.7 (130)	15.4 (136)
CMP63S	M_{max} Nm (lb in)	3.1 (27)	3.6 (32)	4.5 (40)	5.6 (50)	4.4 (39)	5.8 (51)	6.9 (61)	8.6 (76)	10.0 (89)	11.1 (98)	
CMP63M	M_{max} Nm (lb in)				6.3 (56)	4.8 (42)	6.5 (58)	8.0 (71)	10.4 (92)	13.0 (115)	15.6 (138)	20.0 (177)
CMP63L	M_{max} [Nm (lb in)						6.5 (58)	8.1 (72)	10.8 (96)	13.8 (122)	17.0 (150)	23.3 (206)
CMP71S	M_{max} Nm (lb in)						5.7 (50)	7.1 (63)	9.4 (83)	11.7 (104)	14.1 (125)	17.6 (156)
CMP71M	M_{max} Nm (lb in)								9.2 (81)	11.9 (105)	14.9 (132)	20.7 (183)
CMP71L	M_{max} Nm (lb in)								9.8 (87)	12.9 (114)	16.5 (146)	24.2 (214)
CMP80S	M_{max} Nm (lb in)									12.3 (109)	15.9 (141)	23.5 (208)
CMP80M	M_{max} Nm (lb in)										17.1 (151)	25.3 (224)
CMP80L	M_{max} Nm (lb in)											26.1 (231)

Assignment **MOVIDRIVE® MDX61B0150-5_3 - MDX61B1320-5_3** (sizes 3 - 6):

Motor		MOVIDRIVE® MDX61B...-5_3 (AC 400 V units) in SERVO operating modes (P700)										
		0150	0220	0300	0370	0450	0550	0750	0900	1100	1320	
CMP63M	M_{max} Nm (lb in)	21.4 (189)										
CMP63L	M_{max} Nm (lb in)	28.1 (249)	30.4 (269)									
CMP71S	M_{max} Nm (lb in)	19.1 (169)	19.2 (170)									
CMP71M	M_{max} Nm (lb in)	24.9 (220)	29.3 (259)	30.8 (273)								
CMP71L	M_{max} Nm (lb in)	30.9 (273)	39.5 (350)	44.0 (389)	46.2 (409)	46.9 (415)						
CMP80S	M_{max} Nm (lb in)	29.8 (264)	37.1 (328)	41.0 (363)	42.1 (373)							
CMP80M	M_{max} Nm (lb in)	33.0 (292)	44.4 (393)	52.7 (466)	57.8 (512)	62.4 (552)	62.6 (554)					
CMP80L	M_{max} Nm (lb in)	34.5 (305)	48.5 (429)	61.3 (543)	71.9 (636)	83.0 (735)	92.0 (814)	102.4 (906)	106.8 (814)			



B			
Basic recommendations for motor selection	15		
C			
Combination overview for DRL motors			
Rated speed 1200 rpm, dynamics package 1	35		
Rated speed 1200 rpm, dynamics package 2	36		
Rated speed 1700 rpm, dynamics package 1	37		
Rated speed 1700 rpm, dynamics package 2	38		
Rated speed 2100 rpm, dynamics package 1	39		
Rated speed 2100 rpm, dynamics package 2	40		
Rated speed 3000 rpm, dynamics package 1	41		
Rated speed 3000 rpm, dynamics package 2	42		
I			
Important notes	4		
M			
Motor selection	15		
Basic recommendations for motor selection	15		
Motor selection for asynchronous			
AC motors (VFC)	15		
DRE motor selection delta AC 230 / 50 Hz ..	23		
DRE motor selection delta/star AC 230/400 V / 50 Hz	19		
DRE motor selection double-star AC 230 V / 60 Hz	28		
DRE motor selection double-star/star AC 230/460 V / 60 Hz	26		
DRP motor selection delta AC 230 / 50 Hz ..	24		
DRP motor selection delta/star AC 230/400 V / 50 Hz	20		
DRS motor selection delta AC 230 / 50 Hz ..	22		
DRS motor selection delta/star AC 230/400 V / 50 Hz	18		
DRS motor selection double-star AC 230 V / 60 Hz	27		
DRS motor selection double-star/star AC 230/460 V / 60 Hz	25		
Dynamic applications	17		
Examples for delta/star AC 230/400 V / 50 Hz	21		
Speed/torque characteristics	16		
Voltage/frequency characteristic curve	15		
Motor selection for asynchronous			
servomotors (CFC)	29		
CFC mode with torque control	31		
CFC operation with speed control	30		
CT/CV motor selection rated speed 1200 rpm . 35, 36, 37, 38			
CT/CV motor selection rated speed 3000 rpm . 39, 40, 41, 42			
DRE motor selection delta AC 230 / 50 Hz	55		
DRE motor selection delta/star AC 230/400 V / 50 Hz	51		
DRE motor selection double-star AC 230 V / 60 Hz	74		
DRE motor selection double-star/star AC 230/400 V / 60 Hz	70		
DRE motor table	50		
DRE motor table double-star/star AC 230/460 V / 60 Hz	69		
DRL motor table	33		
DRP motor selection delta AC 230 / 50 Hz	61		
DRP motor selection delta/star AC 230/400 V / 50 Hz	57		
DRP motor table	56		
DRS motor selection delta AC 230 / 50 Hz	48		
DRS motor selection delta/star AC 230/400 V / 50 Hz	44		
DRS motor selection double-star AC 230 V / 60 Hz	67		
DRS motor selection double-star/star AC 230/400 V / 60 Hz	63		
DRS motor table	43		
DRS motor table double-star/star AC 230/460 V / 60 Hz	62		
Magnetization current	29		
Motor characteristics	29		
Motor cooling	30		
Notes for DRL motors	32		
Motor selection for synchronous servomotors (SERVO)	75		
Basic recommendations	76		
CMP motor selection 400 V, rated speed 3000 rpm	78, 79, 80		
CMP motor selection 400 V, rated speed 4500 rpm	79		
CMP motor selection 400 V, rated speed 6000 rpm	80		
CMP motor table	77		
Motor characteristics	75		
Torque control	76		



Index

P

Prefabricated cables	5
<i>Cable sets for connecting options</i>	
DEH11B/DEH21B	6
<i>Cable sets for connecting the</i>	
CMP80-100 motors	5
<i>Meaning of the symbols</i>	6
<i>Overview</i>	5
<i>Overview of the cable sets for connection at</i>	
X15, DEH11B/DEH21B	7

T

Technical data	5
<i>Prefabricated cables</i>	5



Address List

Germany				
Headquarters Production Sales	Bruchsal	SEW-EURODRIVE GmbH & Co KG Ernst-Blickle-Straße 42 D-76646 Bruchsal P.O. Box Postfach 3023 • D-76642 Bruchsal	Tel. +49 7251 75-0 Fax +49 7251 75-1970 http://www.sew-eurodrive.de sew@sew-eurodrive.de	
Service Competence Center	Central	SEW-EURODRIVE GmbH & Co KG Ernst-Blickle-Straße 1 D-76676 Graben-Neudorf	Tel. +49 7251 75-1710 Fax +49 7251 75-1711 sc-mitte@sew-eurodrive.de	
	North	SEW-EURODRIVE GmbH & Co KG Alte Ricklinger Straße 40-42 D-30823 Garbsen (near Hannover)	Tel. +49 5137 8798-30 Fax +49 5137 8798-55 sc-nord@sew-eurodrive.de	
	East	SEW-EURODRIVE GmbH & Co KG Dänkritzter Weg 1 D-08393 Meerane (near Zwickau)	Tel. +49 3764 7606-0 Fax +49 3764 7606-30 sc-ost@sew-eurodrive.de	
	South	SEW-EURODRIVE GmbH & Co KG Domagkstraße 5 D-85551 Kirchheim (near München)	Tel. +49 89 909552-10 Fax +49 89 909552-50 sc-sued@sew-eurodrive.de	
	West	SEW-EURODRIVE GmbH & Co KG Siemensstraße 1 D-40764 Langenfeld (near Düsseldorf)	Tel. +49 2173 8507-30 Fax +49 2173 8507-55 sc-west@sew-eurodrive.de	
	Electronics	SEW-EURODRIVE GmbH & Co KG Ernst-Blickle-Straße 42 D-76646 Bruchsal	Tel. +49 7251 75-1780 Fax +49 7251 75-1769 sc-elektronik@sew-eurodrive.de	
	Drive Service Hotline / 24 Hour Service			+49 180 5 SEWHELP +49 180 5 7394357
	Additional addresses for service in Germany provided on request!			
France				
Production Sales Service	Hagenau	SEW-USOCOME 48-54, route de Soufflenheim B. P. 20185 F-67506 Hagenau Cedex	Tel. +33 3 88 73 67 00 Fax +33 3 88 73 66 00 http://www.usocomme.com sew@usocomme.com	
Production	Forbach	SEW-EUROCOME Zone Industrielle Technopôle Forbach Sud B. P. 30269 F-57604 Forbach Cedex	Tel. +33 3 87 29 38 00	
Assembly Sales Service	Bordeaux	SEW-USOCOME Parc d'activités de Magellan 62, avenue de Magellan - B. P. 182 F-33607 Pessac Cedex	Tel. +33 5 57 26 39 00 Fax +33 5 57 26 39 09	
	Lyon	SEW-USOCOME Parc d'Affaires Roosevelt Rue Jacques Tati F-69120 Vaulx en Velin	Tel. +33 4 72 15 37 00 Fax +33 4 72 15 37 15	
	Paris	SEW-USOCOME Zone industrielle 2, rue Denis Papin F-77390 Verneuil l'Etang	Tel. +33 1 64 42 40 80 Fax +33 1 64 42 40 88	
Additional addresses for service in France provided on request!				



Address List

Algeria			
Sales	Alger	Réducom 16, rue des Frères Zagnoun Bellevue El-Harrach 16200 Alger	Tel. +213 21 8222-84 Fax +213 21 8222-84 reducom_sew@yahoo.fr
Argentina			
Assembly Sales Service	Buenos Aires	SEW EURODRIVE ARGENTINA S.A. Centro Industrial Garin, Lote 35 Ruta Panamericana Km 37,5 1619 Garin	Tel. +54 3327 4572-84 Fax +54 3327 4572-21 sewar@sew-eurodrive.com.ar http://www.sew-eurodrive.com.ar
Australia			
Assembly Sales Service	Melbourne	SEW-EURODRIVE PTY. LTD. 27 Beverage Drive Tullamarine, Victoria 3043	Tel. +61 3 9933-1000 Fax +61 3 9933-1003 http://www.sew-eurodrive.com.au enquires@sew-eurodrive.com.au
	Sydney	SEW-EURODRIVE PTY. LTD. 9, Sleigh Place, Wetherill Park New South Wales, 2164	Tel. +61 2 9725-9900 Fax +61 2 9725-9905 enquires@sew-eurodrive.com.au
Austria			
Assembly Sales Service	Wien	SEW-EURODRIVE Ges.m.b.H. Richard-Strauss-Strasse 24 A-1230 Wien	Tel. +43 1 617 55 00-0 Fax +43 1 617 55 00-30 http://sew-eurodrive.at sew@sew-eurodrive.at
Belarus			
Sales	Minsk	SEW-EURODRIVE BY RybalkoStr. 26 BY-220033 Minsk	Tel.+375 (17) 298 38 50 Fax +375 (17) 29838 50 sales@sew.by
Belgium			
Assembly Sales Service	Brüssel	SEW Caron-Vector S.A. Avenue Eiffel 5 B-1300 Wavre	Tel. +32 10 231-311 Fax +32 10 231-336 http://www.sew-eurodrive.be info@caron-vector.be
Service Competence Center	Industrial Gears	SEW Caron-Vector S.A. Rue de Parc Industriel, 31 BE-6900 Marche-en-Famenne	Tel. +32 84 219-878 Fax +32 84 219-879 http://www.sew-eurodrive.be service-wallonie@sew-eurodrive.be
Brazil			
Production Sales Service	Sao Paulo	SEW-EURODRIVE Brasil Ltda. Avenida Amâncio Gaiolli, 152 - Rodovia Presidente Dutra Km 208 Guarulhos - 07251-250 - SP SAT - SEW ATENDE - 0800 7700496	Tel. +55 11 6489-9133 Fax +55 11 6480-3328 http://www.sew-eurodrive.com.br sew@sew.com.br
Additional addresses for service in Brazil provided on request!			
Bulgaria			
Sales	Sofia	BEVER-DRIVE GmbH Bogdanovetz Str.1 BG-1606 Sofia	Tel. +359 2 9151160 Fax +359 2 9151166 bever@fastbg.net
Cameroon			
Sales	Douala	Electro-Services Rue Drouot Akwa B.P. 2024 Douala	Tel. +237 33 431137 Fax +237 33 431137



Canada				
Assembly Sales Service	Toronto	SEW-EURODRIVE CO. OF CANADA LTD. 210 Walker Drive Bramalea, Ontario L6T3W1	Tel. +1 905 791-1553 Fax +1 905 791-2999 http://www.sew-eurodrive.ca marketing@sew-eurodrive.ca	
	Vancouver	SEW-EURODRIVE CO. OF CANADA LTD. 7188 Honeyman Street Delta. B.C. V4G 1 E2	Tel. +1 604 946-5535 Fax +1 604 946-2513 marketing@sew-eurodrive.ca	
	Montreal	SEW-EURODRIVE CO. OF CANADA LTD. 2555 Rue Leger LaSalle, Quebec H8N 2V9	Tel. +1 514 367-1124 Fax +1 514 367-3677 marketing@sew-eurodrive.ca	
Additional addresses for service in Canada provided on request!				
Chile				
Assembly Sales Service	Santiago de Chile	SEW-EURODRIVE CHILE LTDA. Las Encinas 1295 Parque Industrial Valle Grande LAMPA RCH-Santiago de Chile P.O. Box Casilla 23 Correo Quilicura - Santiago - Chile	Tel. +56 2 75770-00 Fax +56 2 75770-01 http://www.sew-eurodrive.cl ventas@sew-eurodrive.cl	
China				
Production Assembly Sales Service	Tianjin	SEW-EURODRIVE (Tianjin) Co., Ltd. No. 46, 7th Avenue, TEDA Tianjin 300457	Tel. +86 22 25322612 Fax +86 22 25322611 info@sew-eurodrive.cn http://www.sew-eurodrive.cn	
	Assembly Sales Service	Suzhou	SEW-EURODRIVE (Suzhou) Co., Ltd. 333, Suhong Middle Road Suzhou Industrial Park Jiangsu Province, 215021	Tel. +86 512 62581781 Fax +86 512 62581783 suzhou@sew-eurodrive.cn
		Guangzhou	SEW-EURODRIVE (Guangzhou) Co., Ltd. No. 9, JunDa Road East Section of GETDD Guangzhou 510530	Tel. +86 20 82267890 Fax +86 20 82267891 guangzhou@sew-eurodrive.cn
Assembly Sales Service	Shenyang	SEW-EURODRIVE (Shenyang) Co., Ltd. 10A-2, 6th Road Shenyang Economic Technological Development Area Shenyang, 110141	Tel. +86 24 25382538 Fax +86 24 25382580 shenyang@sew-eurodrive.cn	
	Wuhan	SEW-EURODRIVE (Wuhan) Co., Ltd. 10A-2, 6th Road No. 59, the 4th Quanli Road, WEDA 430056 Wuhan	Tel. +86 27 84478398 Fax +86 27 84478388	
Additional addresses for service in China provided on request!				
Colombia				
Assembly Sales Service	Bogotá	SEW-EURODRIVE COLOMBIA LTDA. Calle 22 No. 132-60 Bodega 6, Manzana B Santafé de Bogotá	Tel. +57 1 54750-50 Fax +57 1 54750-44 http://www.sew-eurodrive.com.co sewcol@sew-eurodrive.com.co	
Croatia				
Sales Service	Zagreb	KOMPEKS d. o. o. PIT Erdödy 4 II HR 10 000 Zagreb	Tel. +385 1 4613-158 Fax +385 1 4613-158 kompeks@inet.hr	



Address List

Czech Republic			
Sales	Praha	SEW-EURODRIVE CZ S.R.O. Business Centrum Praha Lužná 591 CZ-16000 Praha 6 - Vokovice	Tel. +420 255 709 601 Fax +420 220 121 237 http://www.sew-eurodrive.cz sew@sew-eurodrive.cz
Denmark			
Assembly Sales Service	Kopenhagen	SEW-EURODRIVEA/S Geminivej 28-30 DK-2670 Greve	Tel. +45 43 9585-00 Fax +45 43 9585-09 http://www.sew-eurodrive.dk sew@sew-eurodrive.dk
Egypt			
Sales Service	Cairo	Copam Egypt for Engineering & Agencies 33 El Hegaz ST, Heliopolis, Cairo	Tel. +20 2 22566-299 + 1 23143088 Fax +20 2 22594-757 http://www.copam-egypt.com/ copam@datum.com.eg
Estonia			
Sales	Tallin	ALAS-KUUL AS Reti tee 4 EE-75301 Peetri küla, Rae vald, Harjumaa	Tel. +372 6593230 Fax +372 6593231 veiko.soots@alas-kuul.ee
Finland			
Assembly Sales Service	Lahti	SEW-EURODRIVE OY Vesimäentie 4 FIN-15860 Hollola 2	Tel. +358 201 589-300 Fax +358 3 780-6211 sew@sew.fi http://www.sew-eurodrive.fi
Production Assembly Service	Karkkila	SEW Industrial Gears OY Valurinkatu 6 FIN-03600 Karkkila	Tel. +358 201 589-300 Fax +358 201 589-310 sew@sew.fi http://www.sew-eurodrive.fi
Gabon			
Sales	Libreville	Electro-Services B.P. 1889 Libreville	Tel. +241 7340-11 Fax +241 7340-12
Great Britain			
Assembly Sales Service	Normanton	SEW-EURODRIVE Ltd. Beckbridge Industrial Estate P.O. Box No.1 GB-Normanton, West- Yorkshire WF6 1QR	Tel. +44 1924 893-855 Fax +44 1924 893-702 http://www.sew-eurodrive.co.uk info@sew-eurodrive.co.uk
Greece			
Sales Service	Athen	Christ. Boznos & Son S.A. 12, Mavromichali Street P.O. Box 80136, GR-18545 Piraeus	Tel. +30 2 1042 251-34 Fax +30 2 1042 251-59 http://www.boznos.gr info@boznos.gr
Hong Kong			
Assembly Sales Service	Hong Kong	SEW-EURODRIVE LTD. Unit No. 801-806, 8th Floor Hong Leong Industrial Complex No. 4, Wang Kwong Road Kowloon, Hong Kong	Tel. +852 36902200 Fax +852 36902211 contact@sew-eurodrive.hk



Hungary			
Sales Service	Budapest	SEW-EURODRIVE Kft. H-1037 Budapest Kunigunda u. 18	Tel. +36 1 437 06-58 Fax +36 1 437 06-50 office@sew-eurodrive.hu
India			
Assembly Sales Service	Vadodara	SEW-EURODRIVE India Private Limited Plot No. 4, GIDC POR Ramangamdi • Vadodara - 391 243 Gujarat	Tel. +91 265 2831086 Fax +91 265 2831087 http://www.seweurodriveindia.com sales@seweurodriveindia.com subodh.ladwa@seweurodriveindia.com
Ireland			
Sales Service	Dublin	Alperon Engineering Ltd. 48 Moyle Road Dublin Industrial Estate Glasnevin, Dublin 11	Tel. +353 1 830-6277 Fax +353 1 830-6458 info@alperon.ie http://www.alperon.ie
Israel			
Sales	Tel-Aviv	Liraz Handasa Ltd. Ahofer Str 34B / 228 58858 Holon	Tel. +972 3 5599511 Fax +972 3 5599512 http://www.liraz-handasa.co.il office@liraz-handasa.co.il
Italy			
Assembly Sales Service	Milano	SEW-EURODRIVE di R. Blickle & Co.s.a.s. Via Bernini,14 I-20020 Solaro (Milano)	Tel. +39 02 96 9801 Fax +39 02 96 799781 http://www.sew-eurodrive.it sewit@sew-eurodrive.it
Ivory Coast			
Sales	Abidjan	SICA Ste industrielle et commerciale pour l'Afrique 165, Bld de Marseille B.P. 2323, Abidjan 08	Tel. +225 2579-44 Fax +225 2584-36
Japan			
Assembly Sales Service	Iwata	SEW-EURODRIVE JAPAN CO., LTD 250-1, Shimoman-no, Iwata Shizuoka 438-0818	Tel. +81 538 373811 Fax +81 538 373814 http://www.sew-eurodrive.co.jp sewjapan@sew-eurodrive.co.jp
Korea			
Assembly Sales Service	Ansan-City	SEW-EURODRIVE KOREA CO., LTD. B 601-4, Banweol Industrial Estate 1048-4, Shingil-Dong Ansan 425-120	Tel. +82 31 492-8051 Fax +82 31 492-8056 http://www.sew-korea.co.kr master@sew-korea.co.kr
	Busan	SEW-EURODRIVE KOREA Co., Ltd. No. 1720 - 11, Songjeong - dong Gangseo-ku Busan 618-270	Tel. +82 51 832-0204 Fax +82 51 832-0230 master@sew-korea.co.kr
Latvia			
Sales	Riga	SIA Alas-Kuul Katlakalna 11C LV-1073 Riga	Tel. +371 7139253 Fax +371 7139386 http://www.alas-kuul.com info@alas-kuul.com



Address List

Lebanon			
Sales	Beirut	Gabriel Acar & Fils sarl B. P. 80484 Bourj Hammoud, Beirut	Tel. +961 1 4947-86 +961 1 4982-72 +961 3 2745-39 Fax +961 1 4949-71 gacar@beirut.com
Lithuania			
Sales	Alytus	UAB Irseva Naujoji 19 LT-62175 Alytus	Tel. +370 315 79204 Fax +370 315 56175 info@irseva.lt http://www.sew-eurodrive.lt
Luxembourg			
Assembly Sales Service	Brüssel	CARON-VECTOR S.A. Avenue Eiffel 5 B-1300 Wavre	Tel. +32 10 231-311 Fax +32 10 231-336 http://www.sew-eurodrive.lu info@caron-vector.be
Malaysia			
Assembly Sales Service	Johore	SEW-EURODRIVE SDN BHD No. 95, Jalan Seroja 39, Taman Johor Jaya 81000 Johor Bahru, Johor West Malaysia	Tel. +60 7 3549409 Fax +60 7 3541404 sales@sew-eurodrive.com.my
Mexico			
Assembly Sales Service	Queretaro	SEW-EURODRIVE MEXIKO SA DE CV SEM-981118-M93 Tequisquiapan No. 102 Parque Industrial Queretaro C.P. 76220 Queretaro, Mexico	Tel. +52 442 1030-300 Fax +52 442 1030-301 http://www.sew-eurodrive.com.mx scmexico@sew-eurodrive.com.mx
Morocco			
Sales	Casablanca	Afit 5, rue Emir Abdelkader MA 20300 Casablanca	Tel. +212 22618372 Fax +212 22618351 ali.alami@premium.net.ma
Netherlands			
Assembly Sales Service	Rotterdam	VECTOR Aandrijftechniek B.V. Industrieweg 175 NL-3044 AS Rotterdam Postbus 10085 NL-3004 AB Rotterdam	Tel. +31 10 4463-700 Fax +31 10 4155-552 http://www.vector.nu info@vector.nu
New Zealand			
Assembly Sales Service	Auckland	SEW-EURODRIVE NEW ZEALAND LTD. P.O. Box 58-428 82 Greenmount drive East Tamaki Auckland	Tel. +64 9 2745627 Fax +64 9 2740165 http://www.sew-eurodrive.co.nz sales@sew-eurodrive.co.nz
	Christchurch	SEW-EURODRIVE NEW ZEALAND LTD. 10 Settlers Crescent, Ferrymead Christchurch	Tel. +64 3 384-6251 Fax +64 3 384-6455 sales@sew-eurodrive.co.nz
Norway			
Assembly Sales Service	Moss	SEW-EURODRIVE A/S Solgaard skog 71 N-1599 Moss	Tel. +47 69 24 10 20 Fax +47 69 24 10 40 http://www.sew-eurodrive.no sew@sew-eurodrive.no



Peru			
Assembly	Lima	SEW DEL PERU MOTORES REDUCTORES S.A.C.	Tel. +51 1 3495280
Sales		Los Calderos, 120-124	Fax +51 1 3493002
Service		Urbanizacion Industrial Vulcano, ATE, Lima	http://www.sew-eurodrive.com.pe sewperu@sew-eurodrive.com.pe
Poland			
Assembly	Lodz	SEW-EURODRIVE Polska Sp.z.o.o.	Tel. +48 42 67710-90
Sales		ul. Techniczna 5	Fax +48 42 67710-99
Service		PL-92-518 Łódź	http://www.sew-eurodrive.pl sew@sew-eurodrive.pl
		24 Hour Service	Tel. +48 602 739 739 (+48 602 SEW SEW) sewis@sew-eurodrive.pl
Portugal			
Assembly	Coimbra	SEW-EURODRIVE, LDA.	Tel. +351 231 20 9670
Sales		Apartado 15	Fax +351 231 20 3685
Service		P-3050-901 Mealhada	http://www.sew-eurodrive.pt infosew@sew-eurodrive.pt
Romania			
Sales	București	Sialco Trading SRL	Tel. +40 21 230-1328
Service		str. Madrid nr.4 011785 Bucuresti	Fax +40 21 230-7170 sialco@sialco.ro
Russia			
Assembly	St. Petersburg	ZAO SEW-EURODRIVE	Tel. +7 812 3332522 +7 812 5357142
Sales		P.O. Box 36	Fax +7 812 3332523
Service		195220 St. Petersburg Russia	http://www.sew-eurodrive.ru sew@sew-eurodrive.ru
Senegal			
Sales	Dakar	SENEMECA	Tel. +221 338 494 770
		Mécanique Générale Km 8, Route de Rufisque B.P. 3251, Dakar	Fax +221 338 494 771 senemeca@sentoo.sn
Serbia			
Sales	Beograd	DIPAR d.o.o.	Tel. +381 11 347 3244 / +381 11 288 0393
		Ustanicka 128a PC Košum, IV floor SCG-11000 Beograd	Fax +381 11 347 1337 office@dipar.co.yu
Singapore			
Assembly	Singapore	SEW-EURODRIVE PTE. LTD.	Tel. +65 68621701
Sales		No 9, Tuas Drive 2	Fax +65 68612827
Service		Jurong Industrial Estate Singapore 638644	http://www.sew-eurodrive.com.sg sewsingapore@sew-eurodrive.com
Slovakia			
Sales	Bratislava	SEW-Eurodrive SK s.r.o.	Tel. +421 2 33595 202
		Rybničná 40 SK-831 06 Bratislava	Fax +421 2 33595 200 sew@sew-eurodrive.sk http://www.sew-eurodrive.sk
	Žilina	SEW-Eurodrive SK s.r.o.	Tel. +421 41 700 2513
		Industry Park - PChZ ulica M.R.Štefánika 71 SK-010 01 Žilina	Fax +421 41 700 2514 sew@sew-eurodrive.sk



Address List

Slovakia			
	Banská Bystrica	SEW-Eurodrive SK s.r.o. Rudlovská cesta 85 SK-974 11 Banská Bystrica	Tel. +421 48 414 6564 Fax +421 48 414 6566 sew@sew-eurodrive.sk
	Košice	SEW-Eurodrive SK s.r.o. Slovenská ulica 26 SK-040 01 Košice	Tel. +421 55 671 2245 Fax +421 55 671 2254 sew@sew-eurodrive.sk
Slovenia			
Sales Service	Celje	Pakman - Pogonska Tehnika d.o.o. Ul. XIV. divizije 14 SLO - 3000 Celje	Tel. +386 3 490 83-20 Fax +386 3 490 83-21 pakman@siol.net
South Africa			
Assembly Sales Service	Johannesburg	SEW-EURODRIVE (PROPRIETARY) LIMITED Eurodrive House Cnr. Adcock Ingram and Aerodrome Roads Aeroton Ext. 2 Johannesburg 2013 P.O.Box 90004 Bertsham 2013	Tel. +27 11 248-7000 Fax +27 11 494-3104 http://www.sew.co.za info@sew.co.za
	Cape Town	SEW-EURODRIVE (PROPRIETARY) LIMITED Rainbow Park Cnr. Racecourse & Omuramba Road Montague Gardens Cape Town P.O.Box 36556 Chempet 7442 Cape Town	Tel. +27 21 552-9820 Fax +27 21 552-9830 Telex 576 062 cfoster@sew.co.za
	Durban	SEW-EURODRIVE (PROPRIETARY) LIMITED 2 Monaceo Place Pinetown Durban P.O. Box 10433, Ashwood 3605	Tel. +27 31 700-3451 Fax +27 31 700-3847 hengela@sew.co.za
Spain			
Assembly Sales Service	Bilbao	SEW-EURODRIVE ESPAÑA, S.L. Parque Tecnológico, Edificio, 302 E-48170 Zamudio (Vizcaya)	Tel. +34 94 43184-70 Fax +34 94 43184-71 http://www.sew-eurodrive.es sew.spain@sew-eurodrive.es
Sweden			
Assembly Sales Service	Jönköping	SEW-EURODRIVE AB Gnejsvägen 6-8 S-55303 Jönköping Box 3100 S-55003 Jönköping	Tel. +46 36 3442 00 Fax +46 36 3442 80 http://www.sew-eurodrive.se info@sew-eurodrive.se
Switzerland			
Assembly Sales Service	Basel	Alfred Imhof A.G. Jurastrasse 10 CH-4142 Münchenstein bei Basel	Tel. +41 61 417 1717 Fax +41 61 417 1700 http://www.imhof-sew.ch info@imhof-sew.ch
Thailand			
Assembly Sales Service	Chonburi	SEW-EURODRIVE (Thailand) Ltd. 700/456, Moo.7, Donhuaroh Muang Chonburi 20000	Tel. +66 38 454281 Fax +66 38 454288 sewthailand@sew-eurodrive.com



Tunisia			
Sales	Tunis	T. M.S. Technic Marketing Service 5, Rue El Houdaibiah 1000 Tunis	Tel. +216 71 4340-64 + 71 4320-29 Fax +216 71 4329-76 tms@tms.com.tn
Turkey			
Assembly Sales Service	Istanbul	SEW-EURODRIVE Hareket Sistemleri San. ve Tic. Ltd. Sti. Bagdat Cad. Koruma Cikmazi No. 3 TR-34846 Maltepe ISTANBUL	Tel. +90 216 4419164, 3838014, 3738015 Fax +90 216 3055867 http://www.sew-eurodrive.com.tr sew@sew-eurodrive.com.tr
Ukraine			
Sales Service	Dnepropetrovsk	SEW-EURODRIVE Str. Rabochaja 23-B, Office 409 49008 Dnepropetrovsk	Tel. +380 56 370 3211 Fax +380 56 372 2078 http://www.sew-eurodrive.ua sew@sew-eurodrive.ua
USA			
Production Assembly Sales Service Cooperate Offices	Southeast Region	SEW-EURODRIVE INC. 1295 Old Spartanburg Highway P.O. Box 518 Lyman, S.C. 29365	Tel. +1 864 439-7537 Fax Sales +1 864 439-7830 Fax Manufacturing +1 864 439-9948 Fax Assembly +1 864 439-0566 Fax Confidential/HR +1 864 949-5557 http://www.seweurodrive.com cslyman@seweurodrive.com
Assembly Sales Service	Northeast Region	SEW-EURODRIVE INC. Pureland Ind. Complex 2107 High Hill Road, P.O. Box 481 Bridgeport, New Jersey 08014	Tel. +1 856 467-2277 Fax +1 856 845-3179 csbridgeport@seweurodrive.com
	Midwest Region	SEW-EURODRIVE INC. 2001 West Main Street Troy, Ohio 45373	Tel. +1 937 335-0036 Fax +1 937 440-3799 cstroy@seweurodrive.com
	Southwest Region	SEW-EURODRIVE INC. 3950 Platinum Way Dallas, Texas 75237	Tel. +1 214 330-4824 Fax +1 214 330-4724 csdallas@seweurodrive.com
	Western Region	SEW-EURODRIVE INC. 30599 San Antonio St. Hayward, CA 94544	Tel. +1 510 487-3560 Fax +1 510 487-6433 cshayward@seweurodrive.com
Additional addresses for service in the USA provided on request!			
Venezuela			
Assembly Sales Service	Valencia	SEW-EURODRIVE Venezuela S.A. Av. Norte Sur No. 3, Galpon 84-319 Zona Industrial Municipal Norte Valencia, Estado Carabobo	Tel. +58 241 832-9804 Fax +58 241 838-6275 http://www.sew-eurodrive.com.ve ventas@sew-eurodrive.com.ve sewfinanzas@cantv.net

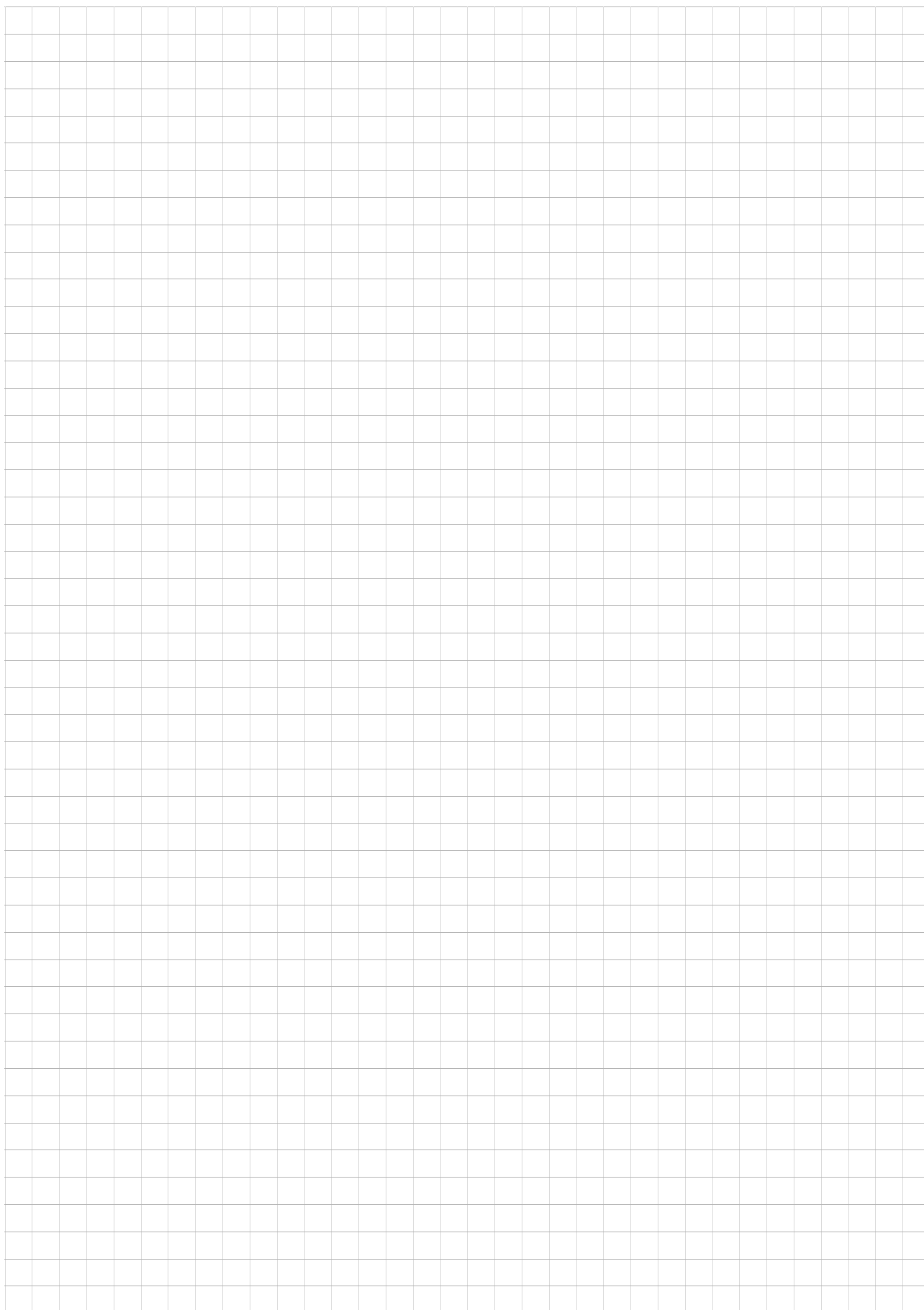



How we're driving the world

With people who think fast and develop the future with you.

With a worldwide service network that is always close at hand.

With drives and controls that automatically improve your productivity.

With comprehensive knowledge in virtually every branch of industry today.

With uncompromising quality that reduces the cost and complexity of daily operations.

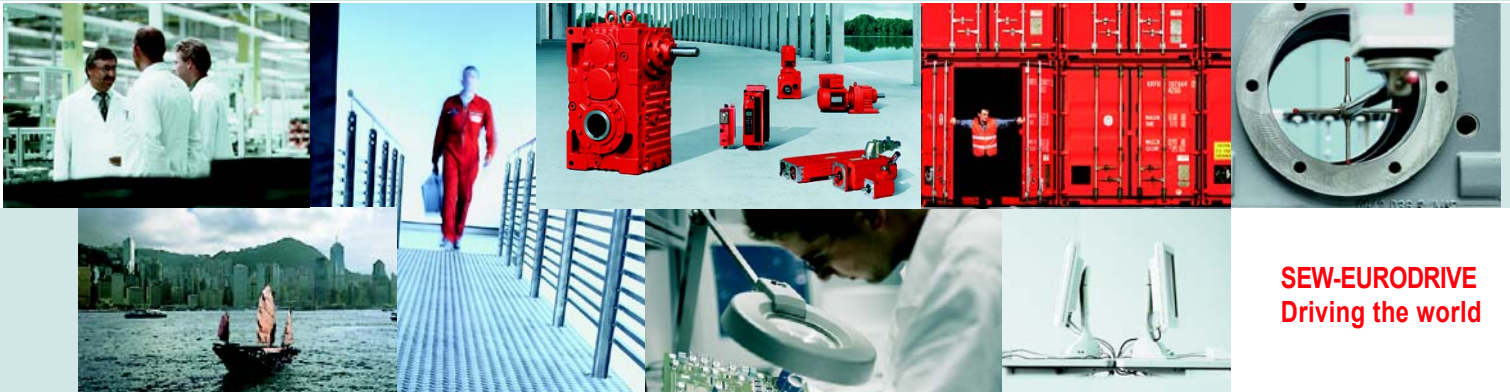

SEW-EURODRIVE
Driving the world

With a global presence that offers responsive and reliable solutions. Anywhere.

With innovative technology that solves tomorrow's problems today.

With online information and software updates, via the Internet, available around the clock.

SEW
EURODRIVE

SEW-EURODRIVE GmbH & Co KG
P.O. Box 3023 · D-76642 Bruchsal / Germany
Phone +49 7251 75-0 · Fax +49 7251 75-1970
sew@sew-eurodrive.com

→ www.sew-eurodrive.com