

Pressure switch FF 4 (GL)

Approved for shipbuilding applications by Germanischer Lloyd
Certificate No.: 26490-05HH

Description

- Pressure switch 2 ... 32 bar range equipped with perbunan diaphragm.
- Pressure switch 60 ... 250 bar range equipped with a plastic plunger and a throttle is fitted as standard.
- All GL-certified pressure switches are equipped with a marine-type cable gland and additional grounding clamp as standard.



FF 4-... GL-approval

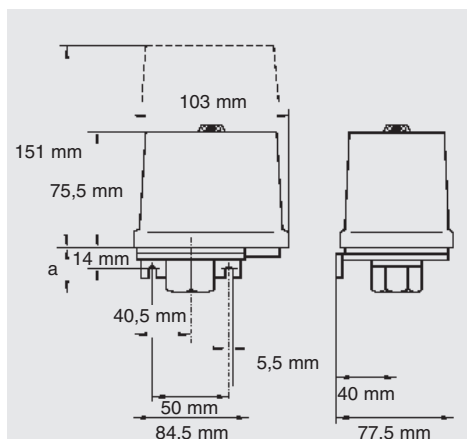

FF 4-2, FF 4-4, FF 4-8,
FF 4-16, FF 4-32

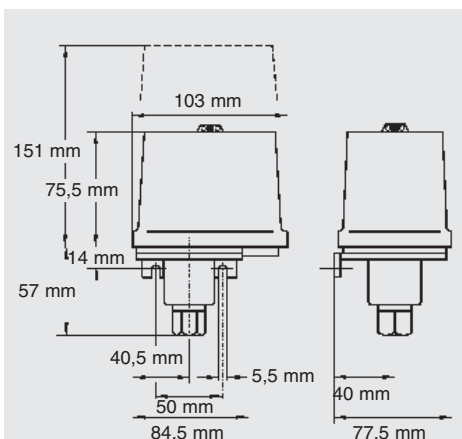

FF 4-12, FF 4-30, FF 4-60,
FF 4-120, FF 4-250

Types

Pressure switch with perbunan diaphragm for mineral oils, water and air.

Pressure connector: H (G 3/8" Female thread, DIN 1725/2), silumin. VDE 0660, IEC 337-1, IEC 553-1

Order reference	Upper switch pt. adjustable (bar)	Lower switch pt. adjustable (bar)	Smallest diff.* (bar)	Max. operating pressure (bar)	Max. test pressure (bar)	Standard setting (bar)	Part No.
FF 4-2 GL DAH	0,11 ... 2	0,04 ... 1,89	0,07 0,11	20	40	0,5 / 1,5	1010122
FF 4-4 GL DAH	0,22 ... 4	0,07 ... 3,75	0,15 0,25	24	40	1 / 3	1010020
FF 4-8 GL DAH	0,5 ... 8	0,2 ... 7,5	0,3 0,5	30	40	2 / 6	1010031
FF 4-16 GL DAH	1 ... 16	0,4 ... 15	0,6 1	36	48	4 / 12	1010117
FF 4-32 GL DAH	2 ... 32	0,8 ... 30	1,2 2	52	64	10 / 20	1010026

* at lower ... higher end of range

Types

High pressure switch with plastic plunger.

Throttle is fitted as standard on these units. This must be removed for use with viscous media.

Pressure connector: H (G 3/8" Female thread, DIN 1725/2), stainless steel. VDE 0660, IEC 337-1, IEC 553-1

Order reference	Upper switch pt. adjustable (bar)	Lower switch pt. adjustable (bar)	Smallest diff.* (bar)	Max. operating pressure (bar)	Max. test pressure (bar)	Standard setting (bar)	Part No.
FF 4-60 GL PAH	8 ... 60	4 ... 52	4 8	100	120	20 / 40	1010088
FF 4-120 GL PAH	16 ... 120	8 ... 104	8 16	200	240	20 / 80	
FF 4-250 GL PAH	30 ... 250	14 ... 226	12 24	400	500	100 / 200	

* at lower ... higher end of range

Pressure switch FF 4 (GL)

Approved for shipbuilding applications by Germanischer Lloyd
Certificate No.: 26490-05HH

Technical data	
Rated operating current at 230 V AC 1	16 A
Rated operating current at 230 V AC 15	6 A
Rated operating current at 230 V DC 13	0,1 A
Permissible motor power 1 ~ 230 V	0,55 kW
Resistance to vibration 10 up to 1000 Hz	4 g
Protection acc. to DIN 40 050/IEC 529 with rubber grommet	IP 54
Protection acc. to DIN 40 050/IEC 529 with cable glands PG 13.5/M20	IP 65
Ambient temperature range	-20 ... +70 °C
Perm. medium temperature (...DAH, PAH)	+70 °C
Repeatability	< 2 % FS

Media compatibility guide

Medium name	Chemical Formula	Stainless steel	Perbunan	Viton	Plastic
Acetone	CH ₃ COCH ₃	X			
Acetylene	HC = CH	X	X	X	X
Air	-	X	X	X	X
Benzene	Sulphur-free	X		X	
Butane	C ₄ H ₁₀	X	X	X	X
Butyl acetate	CH ₃ COOC ₄ H ₉	X			
Butyl alcohol	CH ₃ -CH ₂ -CH ₂ -CH ₂ -OH	X			
Carbon dioxide	CO ₂	X	X	X	X
Carbonic acid	H ₂ CO ₃	X	X	X	X
Chlorine	Cl ₂			X	
Crude oil	-	X	X	X	X
Diesel oil	See fuels	X	X	X	X
Ethyl acetate	CH ₃ COOC ₂ H ₅	X			
Fuels	Diesel oil,	X	X	X	X
	Leaded petrol	X	X	X	X
	Benzene	X		X	
Glycerine	CH ₂ OH-CHOH-CH ₂ OH	X	X	X	X
Glycol	CH ₂ OH-CH ₂ OH	X	X	X	X
Heating fuel oil	See also oils	X	X	X	X
Hydrogen	H ₂	X	X		X
Inert gases	-	X			
Methanol	CH ₃ OH	X			
Methyl chloride	CH ₃ Cl	X			
Natural gas	-	X	X	X	X
Nitrogen	N ₂	X	X	X	X
Oils	Mineral	X	X	X	X
Oils	Vagetable	X	X	X	
Oxygen	O ₂	X		X	
Ozone	-	X		X	
Perchlorethylene	CCl ₂ =CCL ₂	X		X	
Petrol	All types	X		X	
Phenolic acid	C ₆ H ₅ (OH)	X			
Sulphar dioxide	SO ₂	X		d	
Toluene (Metyl benzene)	C ₆ H ₅ CH ₃	X		X	
Trichlorethene	CHCl=CCl ₂	X		X	
Water	Steam / vapor	X	X	X	
Water	Distilled, de-aerated	X	X	X	X
Water	Sea water	X	X		
Xylene	C ₆ H ₄ (CH ₃) ₂	X		X	

X = recommended, d = dry

Pressure switch FF 4 (GL)

Approved for shipbuilding applications by Germanischer Lloyd
Certificate No.: 26490-05HH

Accessories

Order reference	Description	Weight (g)	Part No.
Throttles			
Throttle FF4-2 ... 32	Throttle for series FF4-2 up to 32	3	1011002
Throttle FF4-60 ... 250	Throttle for series FF4-12/30/60/120/250 (stainless steel)	3	1011003
Glands			
H 124-114	Steel gauge fitting, G 3/4" - G 1/2"	180	1071004

Dimensions

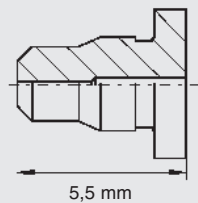

Throttle for FF 4-2 up to 32

weight: ~ 3 g
Order No.: 1011002

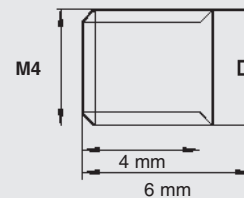

Throttle screw for FF 4-12/30/60/120/250

weight: ~ 3 g (stainless steel)
Order No.: 1011003

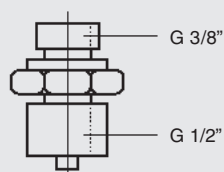

Gauge fitting

Steel, G 3/8" - G 1/2", Type: H 124-114
weight: ~ 18 g
Order No.: 1071004

Circuit diagram

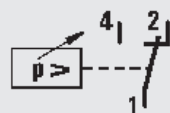

Change-over contact

Pressure switch FF 4 (GL)

Approved for shipbuilding applications by Germanischer Lloyd
Certificate No.: 26490-05HH

Pressure diagrams

Charts show the smallest adjustable differential.

Example per figure FF 4-4: If upper setting is at 3.25 bar, lower setting can be adjusted between 0.07 and 3.0 bar (see arrows in the drawing).

FF 4-2

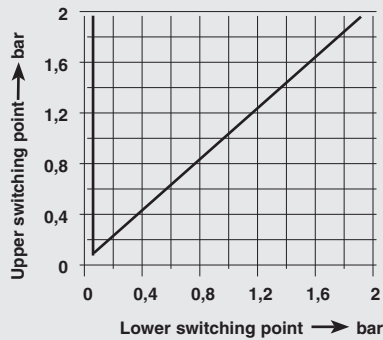

FF 4-4

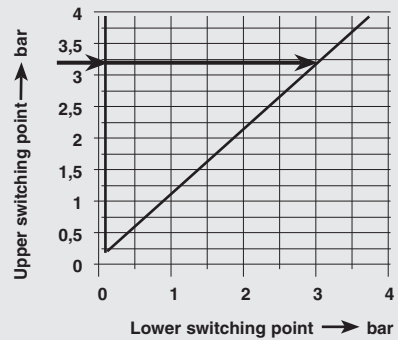

FF 4-8

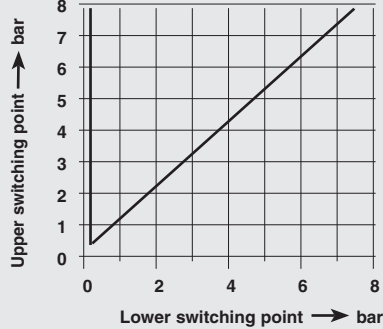

FF 4-12

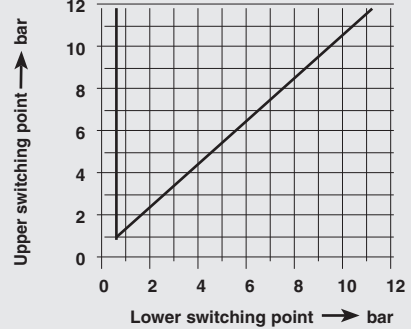

FF 4-16

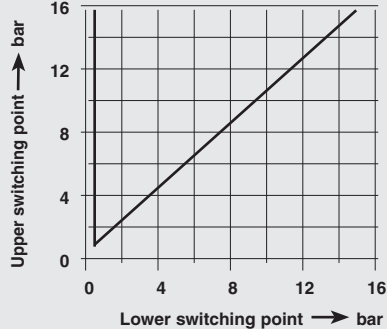

FF 4-30

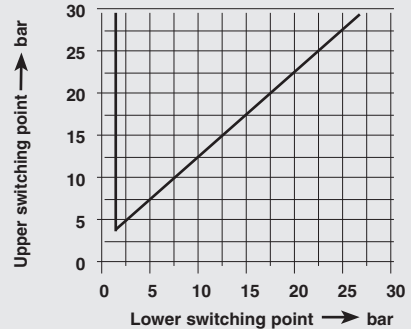

FF 4-32

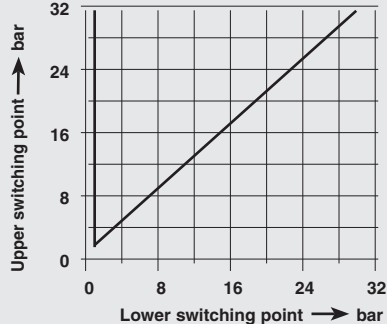

FF 4-60

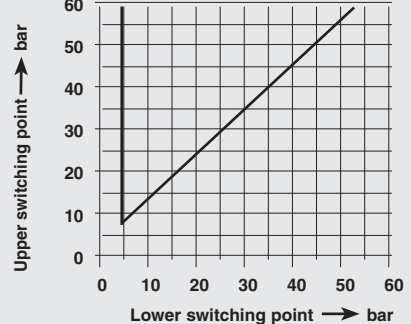

Pressure switch FF 4 (GL)

Approved for shipbuilding applications by Germanischer Lloyd
Certificate No.: 26490-05HH



Pressure diagrams

FF 4-120

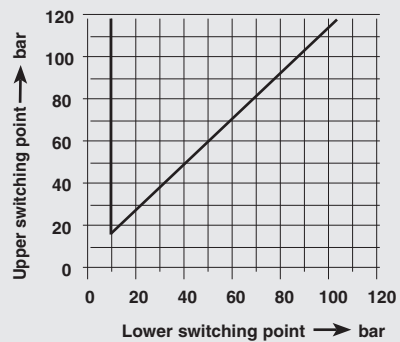

FF 4-250

