

DS-2CE56C0T-IRMMF HD 720p Indoor IR Dome Camera



Key Features

- 1 megapixel high performance CMOS
- Analog HD output, up to 720p resolution
- Day/Night switch
- DNR
- Smart IR
- Up to 20 m IR distance
- Switchable TVI/AHD/CVI/CVBS



Specifications

Camera	
Image Sensor	1 MP CMOS image sensor
Signal System	PAL/NTSC
Effective Pixels	1296 (H) × 732 (V)
Min. illumination	0.01 Lux@(F1.2, AGC ON), 0 Lux with IR
Shutter Time	1/25 (1/30) s to 1/50,000 s
Lens	2.8 mm, 3.6 mm, 6 mm optional
	Field of view: 70.9°(3.6 mm), 92°(2.8 mm), 56.7°(6 mm)
Lens Mount	M12
Day & Night	ICR
Angle Adjustment	Pan: 0° to 350°, Tilt: 0° to 70°, Rotation: 0° to 350°
Synchronization	Internal synchronization
Video Frame Rate	720p@25fps/720p@30fps
HD Video Output	1 analog HD output
S/N Ratio	>62 dB
General	
Operating Conditions	-40 °C to 60 °C (-40 °F to 140 °F), Humidity: 90% or less (non-condensation)
Power Supply	12 V DC ± 15%
Power Consumption	Max. 4 W
IR Range	Up to 20 m
Dimensions	Φ 98 mm × 65.4 mm (3.86" × 2.57")
Weight	240 g (0.53 lb.)

Order Models

DS-2CE56C0T-IRMMF

Dimensions

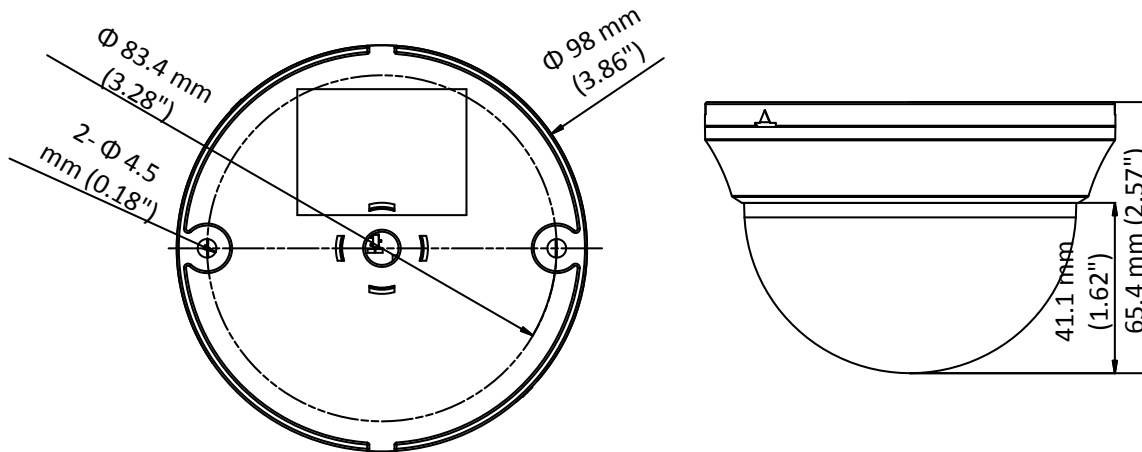

Accessories



DS-1H18
Video Balun



X41T
Camera Tester

Distributed by



Headquarters

No.555 Qianmo Road, Binjiang District,
Hangzhou 310051, China
T +86-571-8807-5998
overseasbusiness@hikvision.com

Hikvision Poland
T +48-22-460-01-50
poland@hikvision.com

Hikvision USA
T +1-909-895-0400
sales.usa@hikvision.com

Hikvision India
T +91-22-28469900
sales@pramahikvision.com

Hikvision UK
T +44-1628-9021-4
support.uk@hikvision.com

Hikvision Europe
T +31-23-5542770
saleseuro@hikvision.com

Hikvision Italy
T +39-0438-6902
info.it@hikvision.com

Hikvision Singapore
T +65-6684-4718
sg@hikvision.com

Hikvision Middle East
T +971-4-8816086
salesme@hikvision.com

Hikvision France
T +33(0)1-85-330-444
info.fr@hikvision.com

Hikvision Oceania
T +61-2-8599-4233
salesau@hikvision.com

Hikvision Russia
T +7-495-669-67-99
saleru@hikvision.com

Hikvision Spain
T +34-91-737-16-55
info.es@hikvision.com

Hikvision Hong Kong
T +852-2151-1761