



Product competence

Grooving, parting off and recessing

_COMPETENCE IN MACHINING

Walter Cut – Easy grooving.

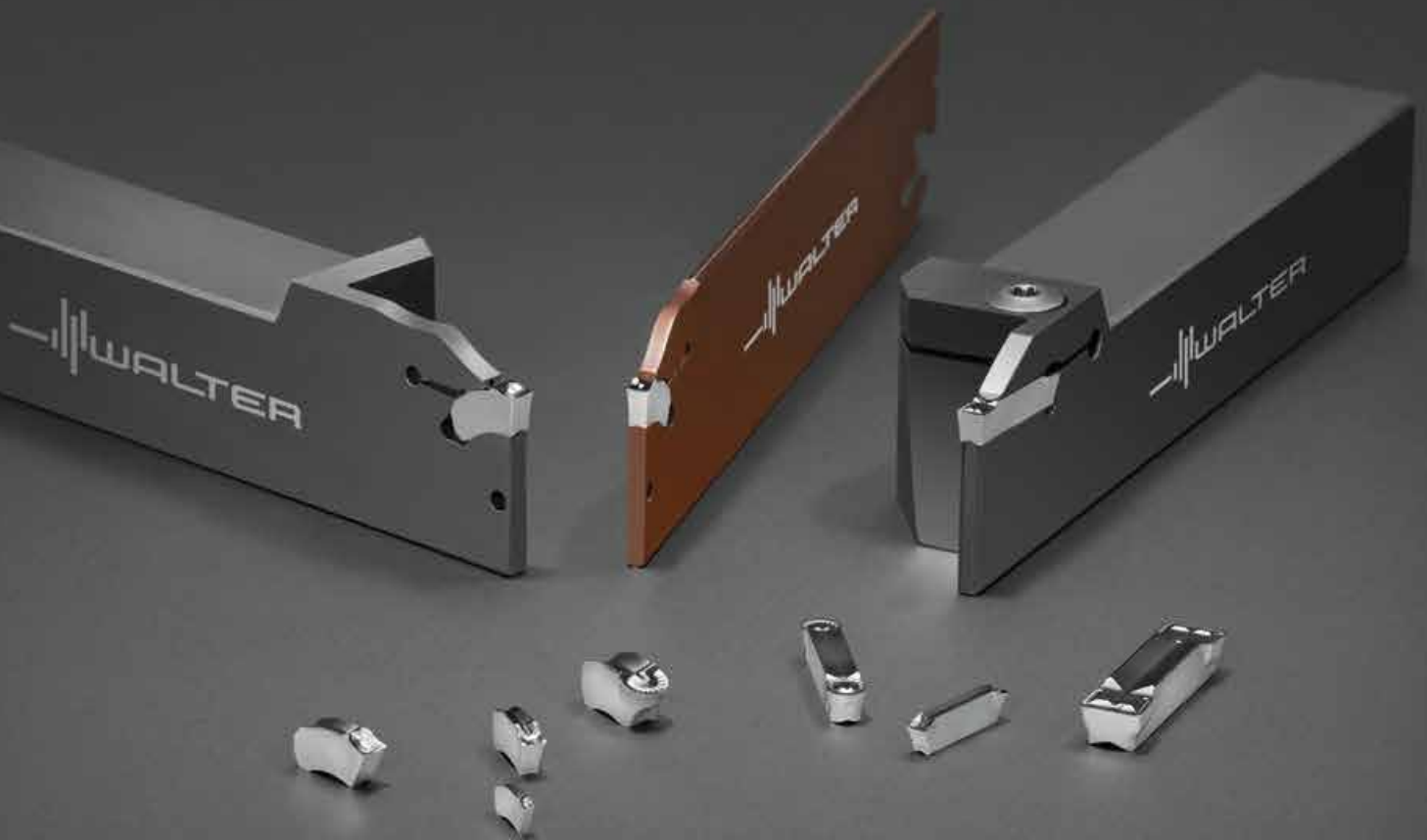



Walter Cut – Easy grooving

Contents

2 Walter Cut product description

Walter Cut tools	2
Tiger-tec® Silver cutting tool material	12
Walter Cut geometries	16

20 Walter Cut inserts

Designation key	20
Walter Select	23
SX inserts	26
GX inserts	27

36 Walter Cut grooving tools

Product range overview	36
Designation key	38
Grooving tools	40

56 Technical information

Cutting data	56
Cutting tool material application tables	58
Geometry overview of inserts	59
Usage information	62
User guide	
– Parting off	64
– Grooving	68
– Recessing	69
– Axial grooving	72
Wear analysis	72
Cutting depths relative to turning diameter	73
Hardness comparison table	74
Calculation formulae	75
Cutting forces of the Walter machining groups	76

Walter Cut: Parting off, grooving and recessing.

1. G1551 GX monoblock tool for low cutting depths at 45°

- Shank sizes 20x20 to 25x25 mm
- Insert widths from 3 to 6 mm
- Cutting depths up to 6 mm with one tool
- Excellent chip evacuation thanks to low tool head height
- Access to the insert screw from above and below
- Page 53

2. NCAI GX modular tool for internal grooving

- Shank diameters 20 to 40 mm
- Insert widths from 0.6 to 6 mm
- Max. cutting depth 19 mm
- Page A 246 in the 2012 Walter General catalogue

3. G1111 GX monoblock tool for axial grooving

- Shank sizes 25x25 mm
- Insert widths from 3 to 6 mm
- Max. cutting depth 25 mm
- Excellent chip evacuation thanks to low tool head height
- Access to the insert screw from above and below
- Page 54

4. G1511 GX monoblock tool for low cutting depths

- Shank sizes 20x20 to 25x25 mm
- Insert widths from 2 to 6 mm
- Cutting depths up to 6 mm
- Excellent chip evacuation thanks to low tool head height
- Access to the insert screw from above and below
- Page 52

5. G2042N SX deep parting blade

- Blade height 26 to 46 mm
- Insert widths from 2 to 6 mm
- Cost-effective, single-edged parting off solution up to a diameter of 160 mm
- Page 43

6. G2012 SX monoblock tool with internal coolant supply

- Shank sizes 12x12 to 25x25 mm
- Insert widths from 1.5 to 6 mm
- For grooving and parting off up to a diameter of 80 mm
- With internal coolant supply via G1/8" connections
- Page 42

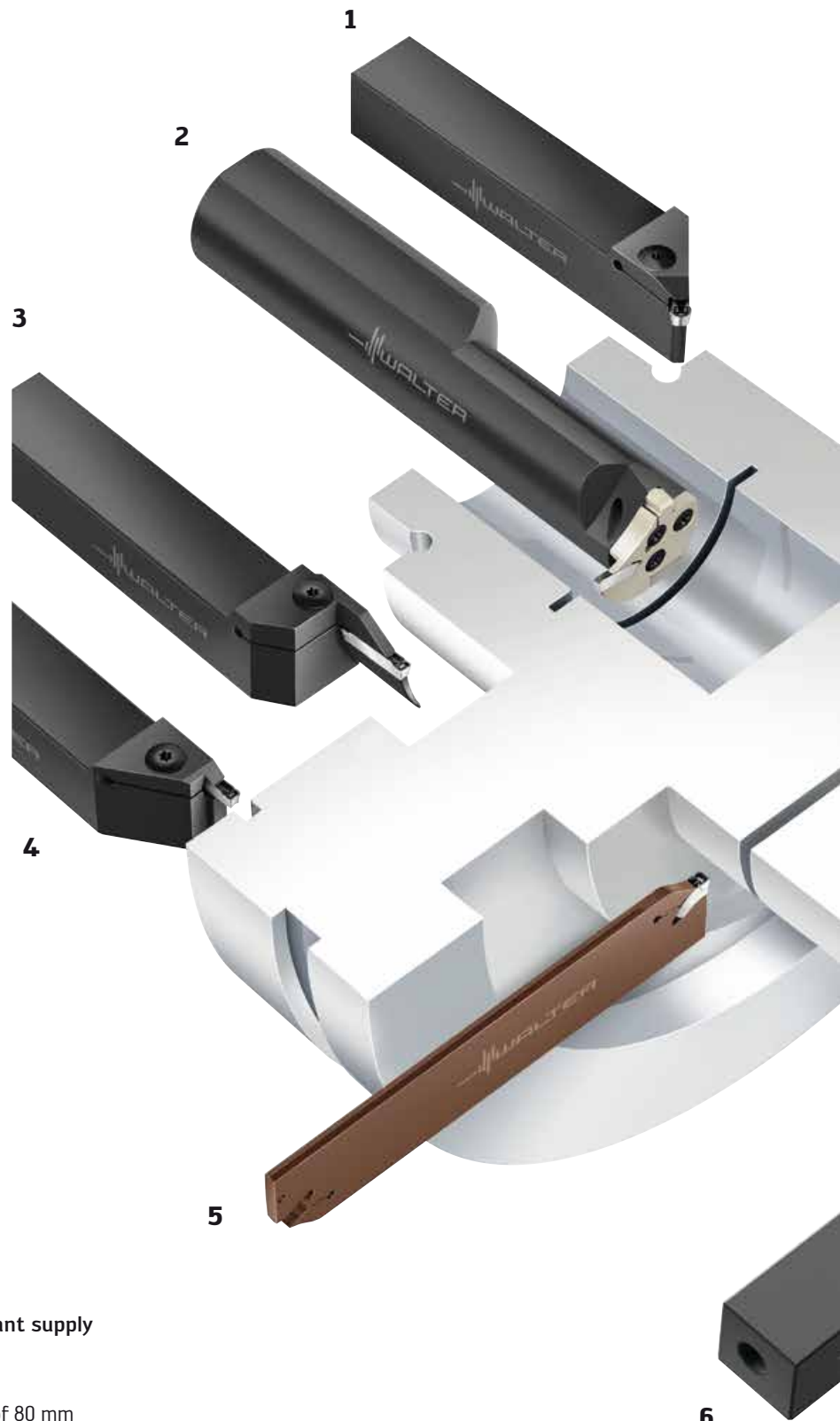

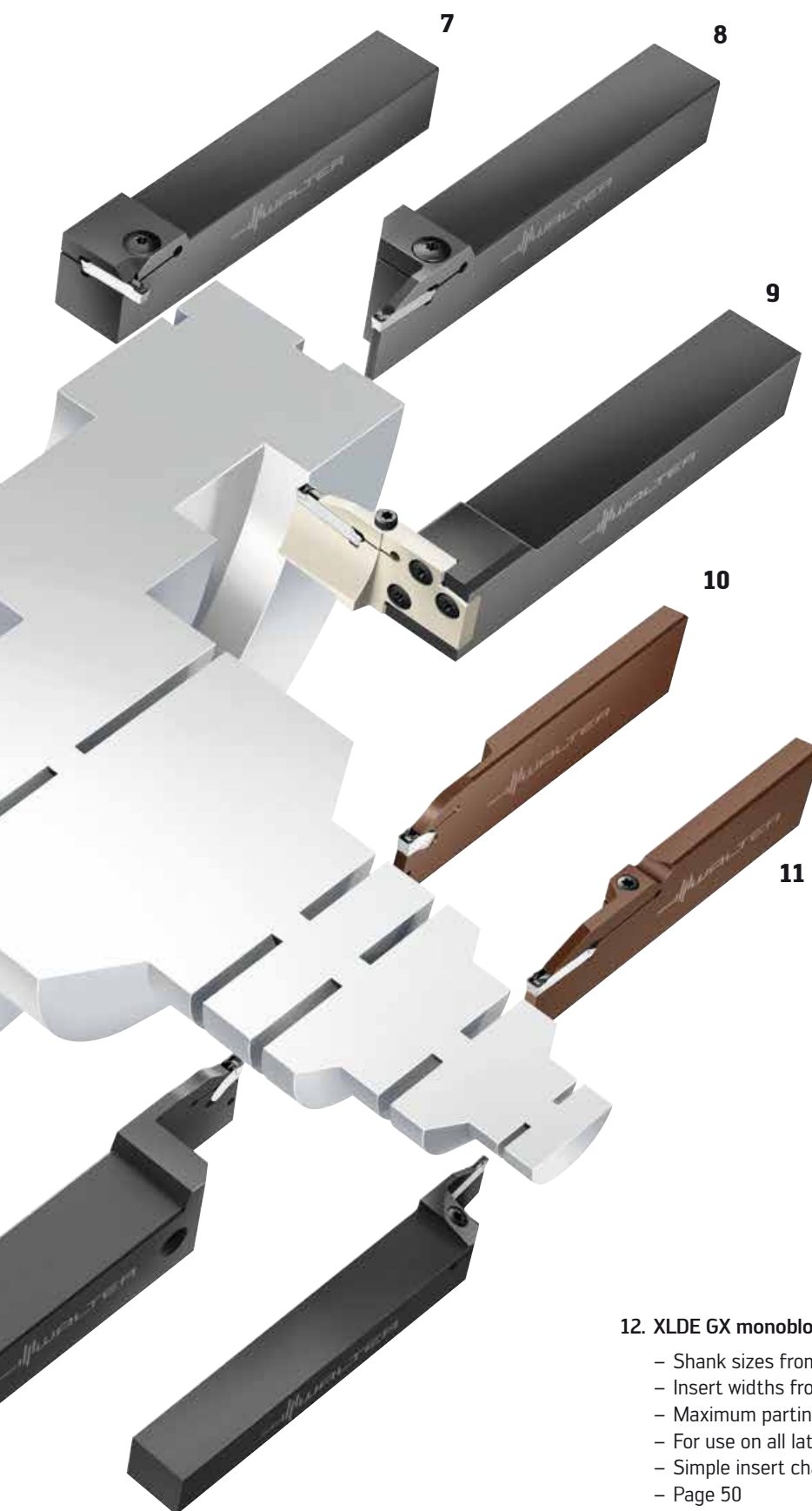

7. G1521 90° GX monoblock tool for low cutting depths

- 20x20 to 25x25 mm
- Insert widths from 2 to 6 mm and cutting depths of up to 6 mm with one tool
- Excellent chip evacuation thanks to low tool head height
- Access to the insert screw from above and below
- Page 52

8. G1011 GX monoblock tool

- Shank sizes 12x12 to 32x32 mm
- Insert widths from 2 to 8 mm
- Max. cutting depth 32 mm
- Access to the insert screw from above and below
- Excellent chip evacuation thanks to low head height
- Page 40

9. NCOE GX modular tool for axial grooving

- Shank sizes 25x25 to 32x32 mm
- Insert widths from 3 to 6 mm
- Max. cutting depth 21 mm
- Page 232 onwards in the 2012 Walter General catalogue

10. G2042R/L SX reinforced-design parting blade

- Blade heights of 26 and 32 mm
- Insert widths from 1.5 to 4 mm
- For grooving and parting off diameters up to 65 mm
- Contra version available
- Page 44

11. G1041 GX reinforced-design parting blade

- Blade heights of 26 and 32 mm
- Insert widths from 1.5 to 4 mm
- For grooving and parting off diameters up to 65 mm
- Contra version available
- Page 46

12. XLDE GX monoblock tool for small part production

- Shank sizes from 10x10 up to 20x20 mm
- Insert widths from 1.5 to 3.0 mm
- Maximum parting diameter of 32 mm
- For use on all lathes including centre and multi-spindle machines
- Simple insert changing thanks to angular access to clamping screw
- Page 50

12

Walter Cut G2012 – SX monoblock tools with internal cooling for all lathes including centre and multi-spindle machines

THE TOOLS

- Internal coolant supply
- G2012 in shank sizes 1212, 1616, 2020 and 2525 mm
- Insert widths 2, 3, 4, 5 and 6 mm
- Parting off up to 80 mm diameter

THE APPLICATION

- For use on lathes of all types, in particular:
 - Long bed automatic lathes
 - Centre lathes
 - Multi-spindle machines
 - Bar feed lathes
- Ideally suited for small parts production and the bar turning industry

YOUR ADVANTAGES

- State-of-the-art tool technology for grooving and parting off
- Direct coolant outlet near the cutting edge provides optimum cooling
- Longer tool life and productivity thanks to optimised cooling
- No downtime due to the formation of long chips in production
- User-friendly self-clamping system for fast replacement of the cutting edge

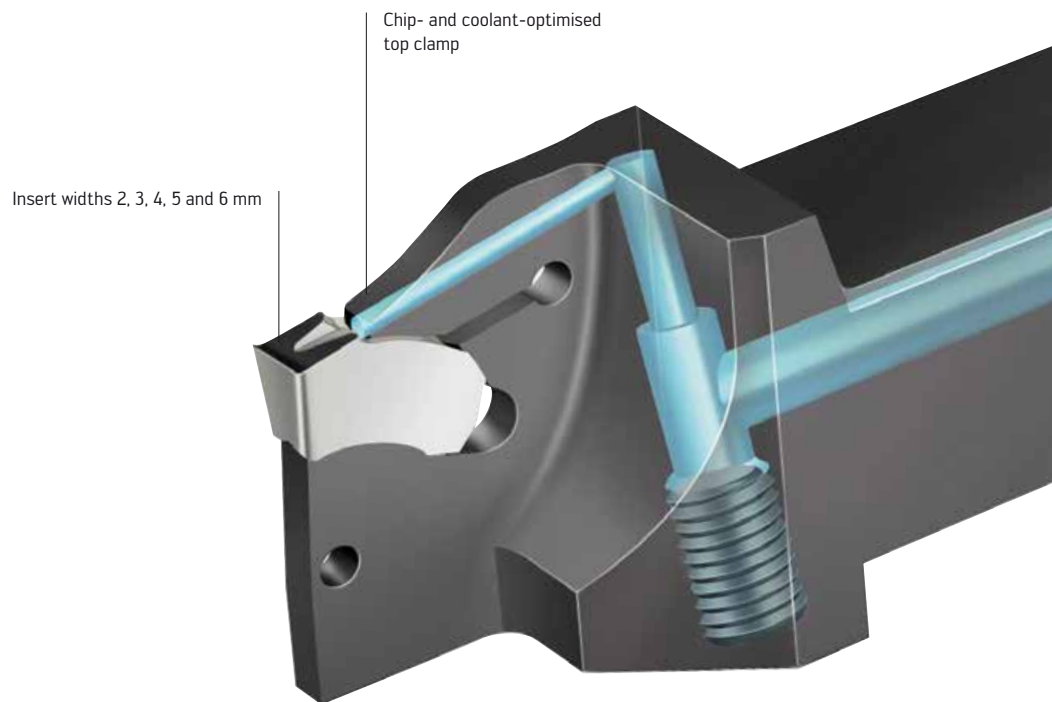

HOW IT WORKS

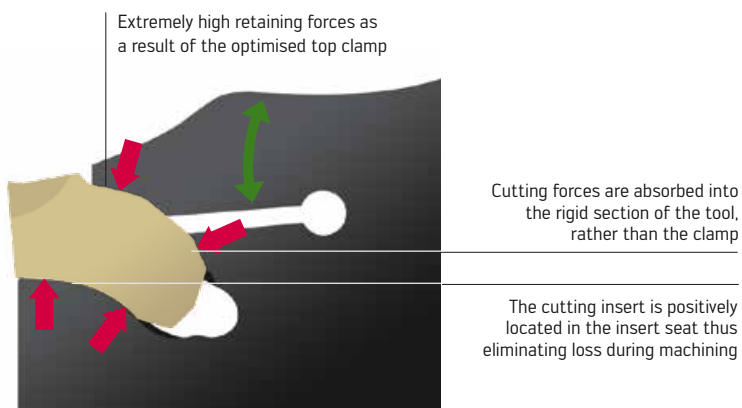

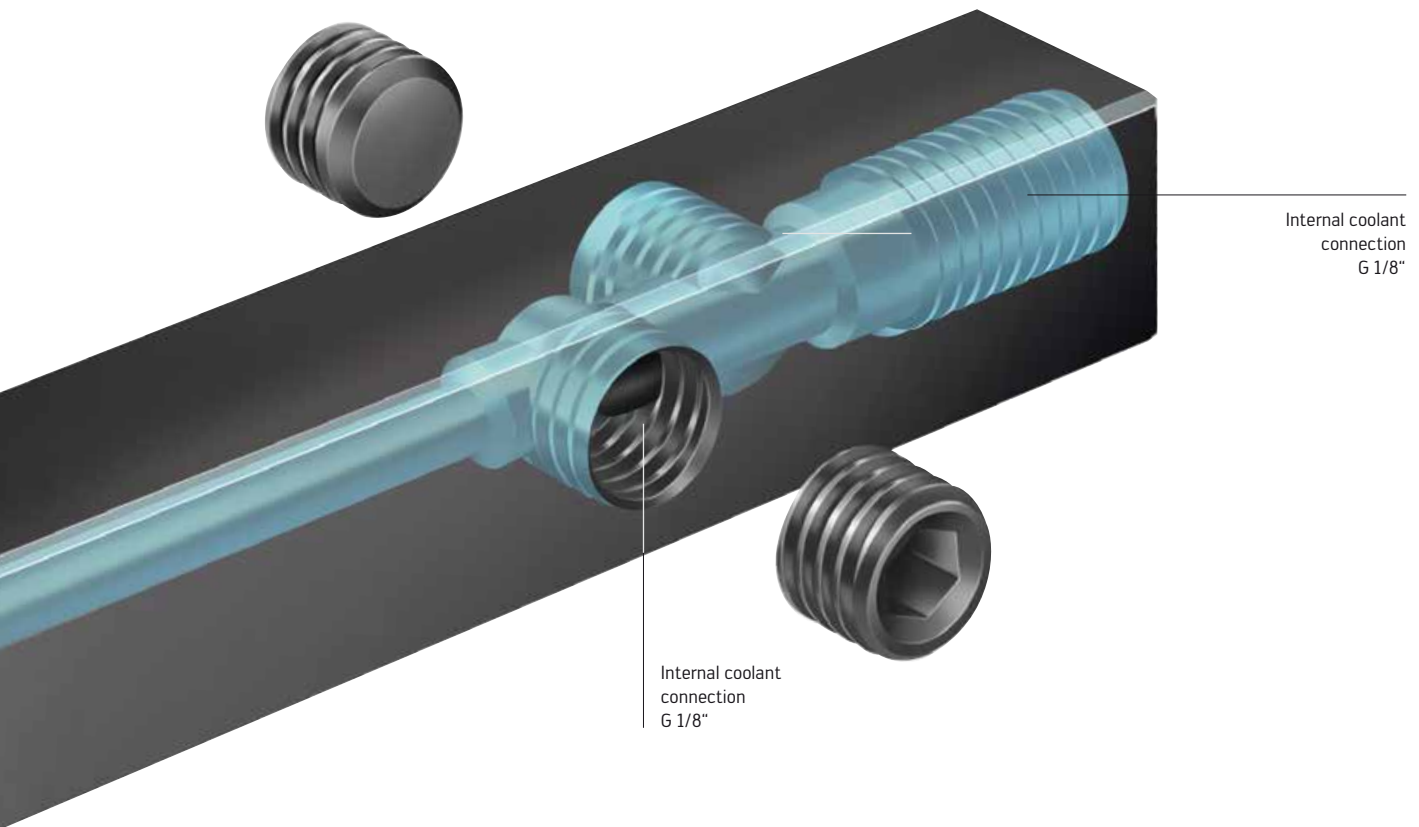

Monoblock tools with internal coolant supply
1212 and 1616 mm shanks

Type: G2012

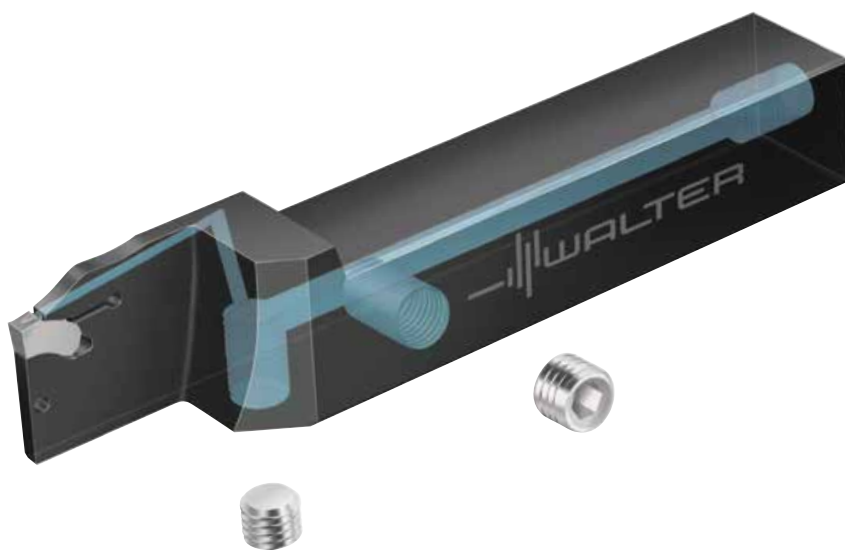

Monoblock tools with internal coolant supply
2020 and 2525 mm shanks

Type: G2012



Watch product video:
Scan this QR code or go directly to
<http://goo.gl/jJ2nMS>



Watch product video:
Scan this QR code or go directly to
<http://goo.gl/viJ9A>

Walter Cut G1041R/L and G2042R/L: Reinforced parting blades for even greater stability.

THE TOOLS

- G2042R/L and G1041R/L parting blades with reinforced shank
- Blade heights of 26 and 32 mm
- Insert widths from 1.5 to 4 mm
- Available as right- and left-hand version
- Grooving to a cutting depth of 33 mm and parting off up to a diameter of 65 mm
- Contra version available

THE APPLICATION

- For grooving and parting off on all types of lathes
- For parting off operations where space is limited
- For parting off operations with low stability loss when using long tool projections
- First choice when using parting blades

YOUR ADVANTAGES

- Long tool life
- Low vibration tendency thanks to reinforced shank
- Can be used on all conventional clamping blocks
- High level of process reliability thanks to stable tool design

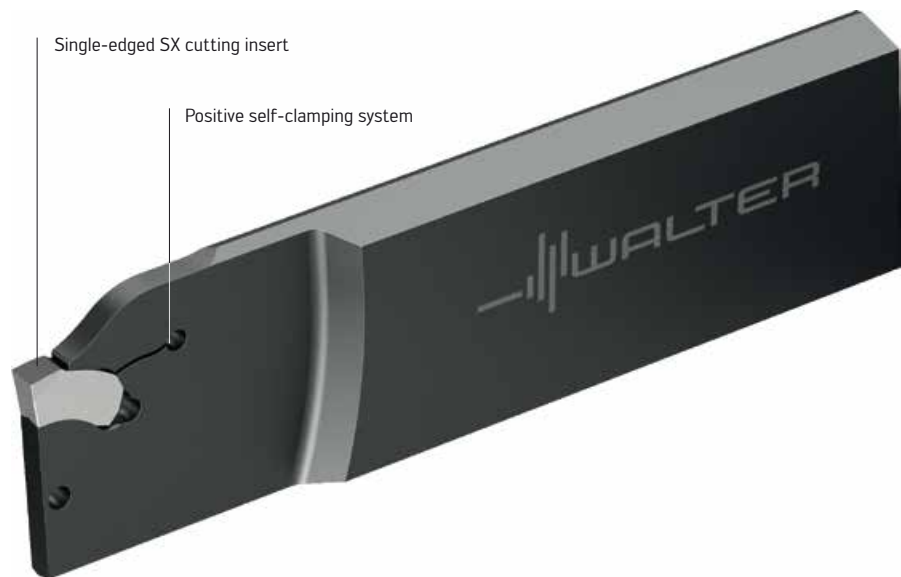

Walter Cut parting blade

Type: G2042R/L

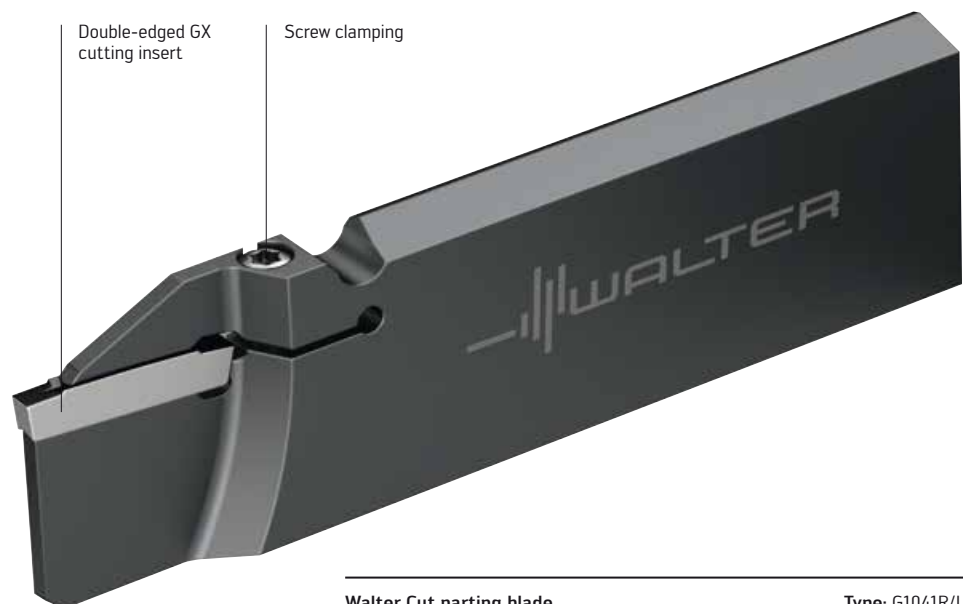
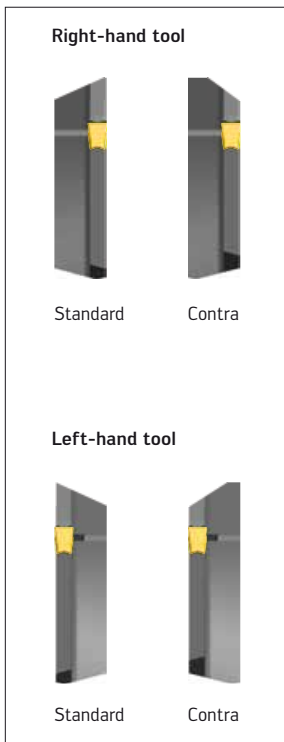

Walter Cut parting blade

Type: G1041R/L

Walter Cut G1042N and G2042N: Parting blades with neutral design.

THE TOOLS

- G2042N and G1042N deep parting blades with self-clamping system
- Blade heights of 26, 32 and 46 mm
- Insert widths from 2.0 to 6 mm
- Grooving to a cutting depth of 80 mm and parting off up to a diameter of 160 mm
- User-friendly self-clamping system

YOUR ADVANTAGES

- Universal application
- Maximum stability between the cutting insert and tool thanks to the latest self-clamping system
- Two insert seats in the tool body
- Adjustable tool projection

THE APPLICATION

- For grooving and parting off on all types of lathes
- Suitable for all industries: The automotive industry, aerospace industry and general mechanical engineering, etc.

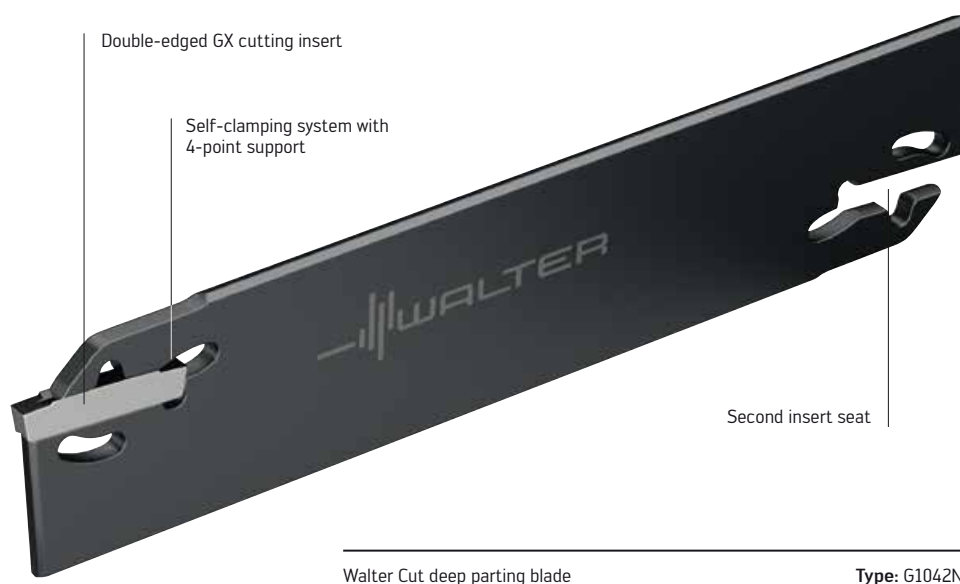
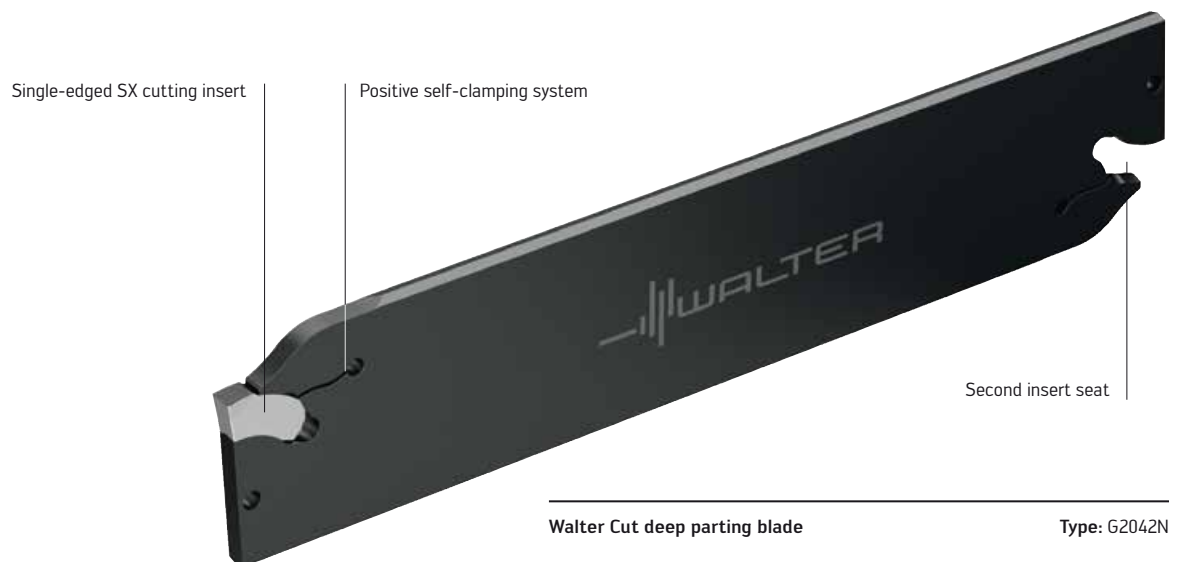

Walter Cut G1011/G1011-P monoblock tool: One for all.

THE TOOL

- Walter Cut monoblock tools for grooving, parting off and recessing
- G1011-P with internal coolant supply directly to the cutting edge
- Clamping screw can be accessed from above and below
- For double-edged GX16, GX24 and GX30 grooving inserts
- Insert widths 2.0 / 2.5 / 3.0 / 4.0 / 5.0 / 6.0 / 8.0 mm
- Cutting depths of 12, 21, 28 and 32 mm
- Shank sizes 12x12 to 32x32 mm

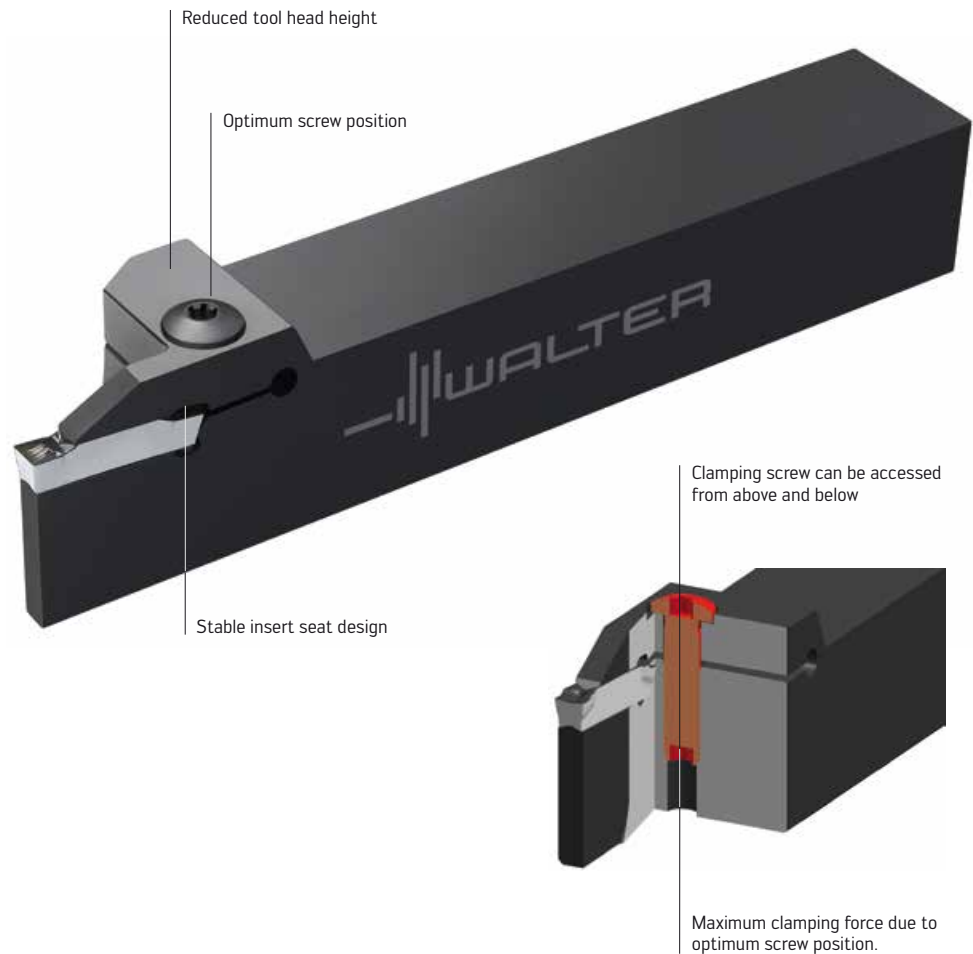

THE APPLICATION

- Parting off up to 42 mm diameter with two cutting edges
- Grooving and recessing operations up to a depth of 32 mm
- For use on lathes of all types
- First choice for all grooving/recessing operations

Walter Cut monoblock toolholder

Type: G1011

Parting off operation on a guide pin

Workpiece material: 60WCrV7 (1.2520), ISO P
 Cutting insert: GX24-2E300N030-UF4
 Cutting tool material: WSM33S Tiger-tec® Silver
 Tool: G1011.2020R-3T216X24

Cutting data

v_c	106 m/min
f	0.1 mm
Insert width	3 mm
Cutting depth	13.5 mm

Comparison of the number of components

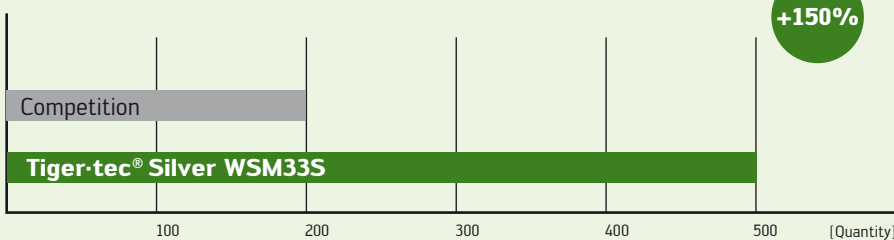

OVERVIEW OF THE ADVANTAGES OF THE G1011 AND G1111



Simple chip evacuation thanks to reduced tool head height [h]

Walter Cut G1111 monoblock tools: A new dimension in axial grooving.

THE APPLICATION

- Axial (face) grooves from a diameter of 34 mm
- Cutting depth up to 25 mm
- Insert width from 3 mm

THE TOOL

- Monoblock tool
- Clamping screw can be accessed from above or below
- Optimum stability thanks to a selection of holders with different cutting depths

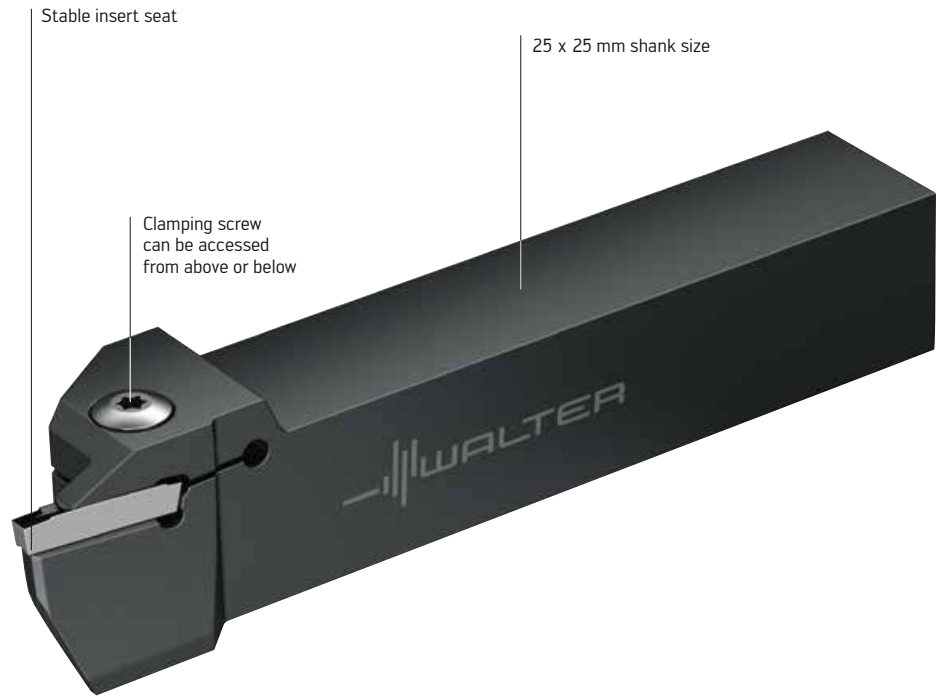

Monoblock toolholder for axial grooving

Type: G1111



Right-hand design



Left-hand design

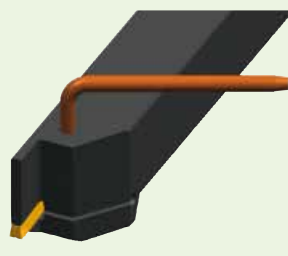
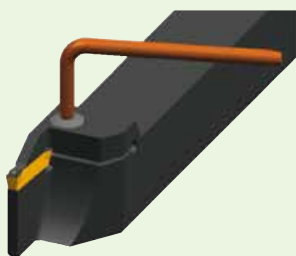

Simple insert changing in normal or inverted attitude

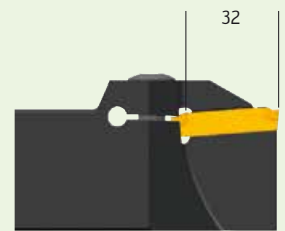
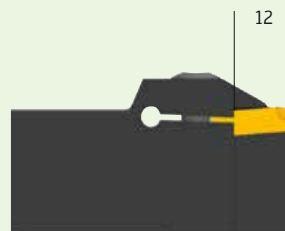

Optimum stability thanks to a selection of holders with different cutting depths

Walter Cut G15XX monoblock tools: Flexible use for low groove depths.

THE TOOLS

G1511 monoblock toolholder

- For cutting depths up to 6 mm
- For GX16 and GX24 inserts
- For radial and axial grooving and recessing
- The same tool can be used for all insert widths from 2 to 6 mm



G1511 monoblock toolholder – straight version

G1521 90° monoblock toolholder

- 90° angle tool design
- For cutting depths up to 6 mm
- For GX16 and GX24 inserts
- For radial and axial grooving and recessing
- The same tool can be used for all insert widths from 2 to 6 mm



G1521 monoblock toolholder – 90° offset

G1551 monoblock toolholder at 45°

- Insert set at 45°
- For cutting depths up to 6 mm
- For GX24 cutting inserts
- For undercuts, relief grooves and copy turning applications
- The same tool can be used for all insert widths from 3 to 6 mm



G1551 monoblock toolholder – set to 45°

THE APPLICATION

- For low groove depths, e.g.:
 - Circlip grooves
 - Sealing ring grooves
 - Thread relief grooves
- For axial and radial grooving
- Compatible with all types of lathe

YOUR ADVANTAGES

- Low inventory costs thanks to tool bodies accepting different cutting-edge widths
- Easy insert changing thanks to clamping screw accessible from above and below
- Maximum productivity when combined with **Tiger-tec® Silver** cutting tool materials

Walter Cut XLDE monoblock tool: Especially for small part production.

THE TOOL

- Walter Cut monoblock tools have been specially designed for parting off
- Clamping screw with double inclination of 20° in axial and radial directions
- for double-edged GX16 grooving inserts
- Insert widths: 1.5 / 2.0 / 2.5 / 3.0 mm
- Shank sizes:
10 x 10, 12 x 12, 16 x 16, 20 x 20 mm

THE APPLICATION

- Parting off of diameters up to 32 mm
- for use on lathes of all types, in particular
 - Long bed automatic lathes
 - Swiss type machines
 - Multi-spindle machines
 - Bar feed lathes
- Ideally suited for small parts production and the bar turning industry, as well as for general mechanical engineering

TOOL DESIGNS



XLDE L ... C



XLDE L



XLDE R



XLDE R ... C

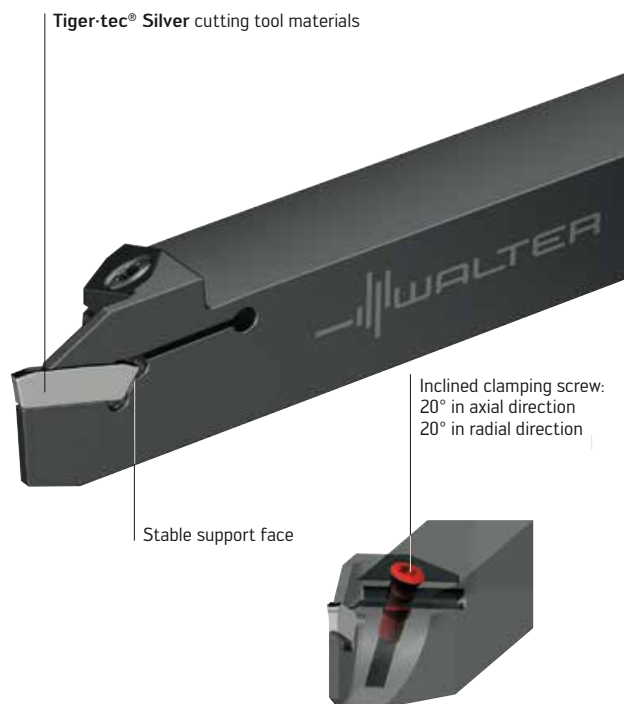

Walter Cut monoblock toolholder

Type: XLDE

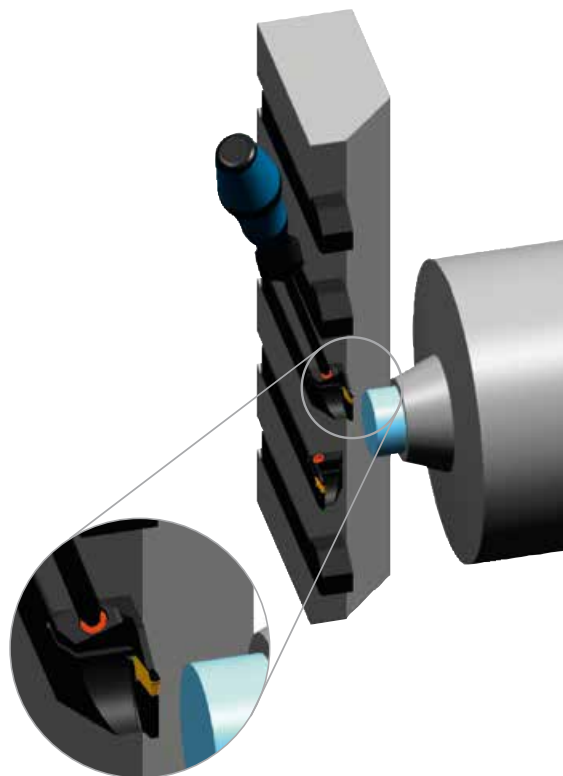

Inserts can be changed in machines with linear units without removing the tool

Parting off of pistons

Workpiece material: HS6-5-2 (1.3343), ISO P
 Cutting insert: GX16-1E200 N020-CF6
 Cutting tool material: WSM43S Tiger-tec® Silver
 Tool: XLDE R 1212K-GX16-1

Cutting data

v_c	85 m/min
f	0.06 mm
s	2 mm
D	10 mm

Comparison of the number of components

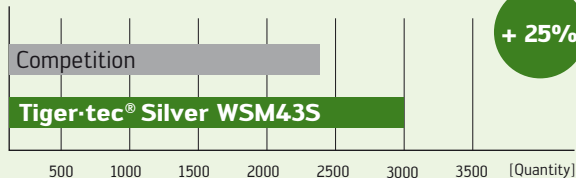

Walter Tiger-tec® Silver – PVD:

Wear resistance and toughness are not a contradiction.



COMPARISON

Competition

Tiger-tec® Silver PVD

Thermal loading of carbide

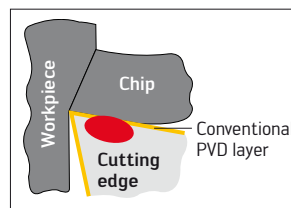

High level of heat entry into the carbide

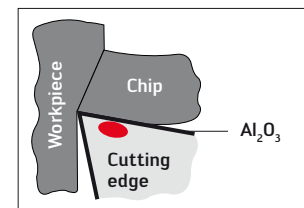

Thermal protection by Al_2O_3

Surface structure of coating

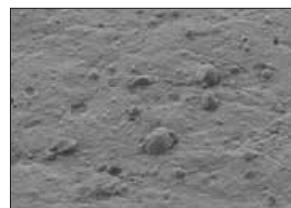

High level of friction due to surface structure



Reduced friction due to improved surface



Tiger-tec® Silver

THE NEW PVD GRADES

WSM13S – (ISO P10, ISO M10, ISO S10)

- Optimum resistance to temperature and wear when machining steels, stainless steels and heat-resistant super alloys
- For finishing and medium machining with uninterrupted cuts.

WSM23S – (ISO P20, ISO M20, ISO S20)

- Resistance to temperature and wear when machining steels, stainless steels and heat-resistant super alloys
- For use in stable conditions, with high cutting speeds and also when oil is used as the lubricant

WSM33S – (ISO P30, ISO M30, ISO S30)

- 1. First choice for machining steels, stainless steels and heat-resistant super alloys
- For use under normal conditions
- Covers the majority of applications
- Combination of outstanding wear resistance and a high degree of toughness

Overview of Tiger-tec® Silver cutting materials

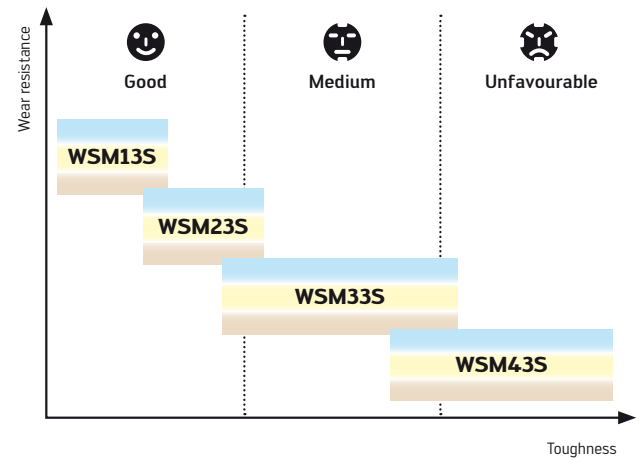

WSM43S – (ISO P40, ISO M40, ISO S40)

- Maximum toughness and process reliability when machining steels, stainless steels and heat resistant super alloys
- Ideal grade for machining interrupted cuts, low cutting speeds and unstable clamping or poor machine conditions

YOUR ADVANTAGES

- Unique combination of thermal stability and toughness ensures unbeatable cost efficiency
- Maximum process reliability thanks to improved cutting edge stability
- Low tendency for build-up on the cutting edge due to improved surface structure and sharp cutting edge with thin **Tiger-tec® Silver** PVD Al_2O_3 coating
- Longer tool life thanks to improved layer hardness
- Universal cutting tool material for different ISO material groups
- Excellent machining results thanks to the use of **Tiger-tec® Silver** PVD technology in conjunction with Walter Cut geometries

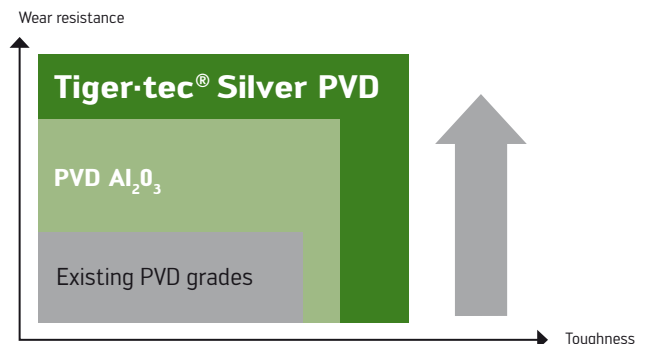

Watch product video:
Scan this QR code
or go directly to
<http://goo.gl/u3dxw>

Walter Tiger-tec® Silver – CVD: High-performance cutting tool materials specially developed for grooving and longitudinal turning.

THE APPLICATION

Primary application - ISO P:

- Typical steels, such as Alloy steel 42CrMo4, Bearing steel 100Cr6 and Non-alloy quality steel C45

Primary application - ISO K:

- All cast iron materials, such as grey cast iron (EN-GJL), ductile cast iron (EN-GJS) and vermicular cast iron (EN-GJV)

THE NEW CVD GRADES

WKP13S (ISO P10, ISO K20)

- Excellent wear resistance and cutting speed
- Continuous cuts

WKP23S (ISO P20, ISO K25)

- Excellent wear resistance and cutting speed
- Continuous cuts and medium interrupted cuts
- Universal grade for approx. 80% of all applications

WKP33S (ISO P30, ISO K30)

- Excellent wear resistance and toughness
- Unfavourable conditions or interrupted cuts

Tiger-tec® Silver CVD coating

- Aluminium oxide with optimised microstructure for maximum crater wear resistance/cutting speed
- Mechanical post-treatment creates compressive stresses to prevent fracture on the cutting edge

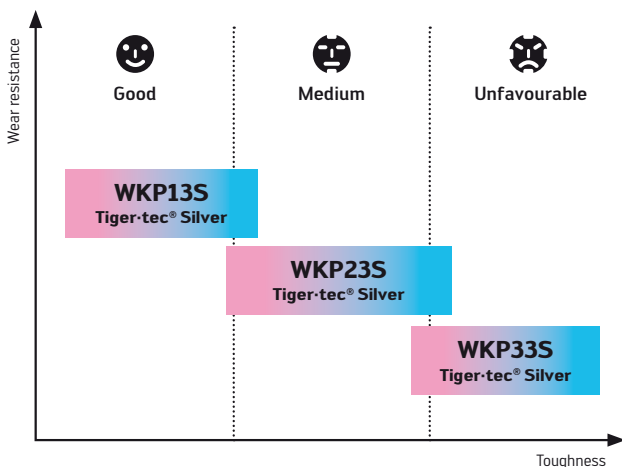

Tiger-tec® Silver



Indicator layer

- Silver flank face for easy wear detection
- Easy detection of unused cutting edges

THE GEOMETRIES

The new WKP13S, WKP23S and WKP33S grades are introduced in combination with the proven recessing geometries UD4, UA4, UF4 and RD4, and the grooving and parting off geometries GD3 and CE4. This means the new **Tiger-tec® Silver** technology is combined with the long-standing experience of our existing geometries.

YOUR ADVANTAGES

- Maximum productivity due to an increase in cutting data with longer tool life thanks to **Tiger-tec® Silver** technology
- Wear-resistant cutting tool material as an alternative to our WSM grades

Axial grooving
2 x 4 mm
Forged blank

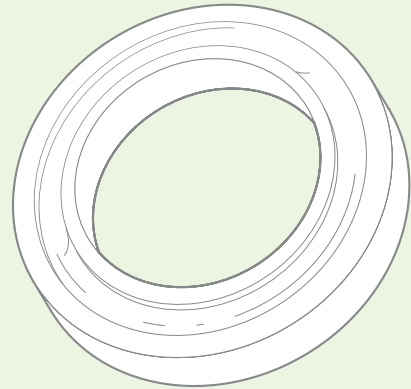

Workpiece material: C45 (1.0503)
Cutting insert: GX24-3E400N04-UD4
Cutting tool material: WKP23S **Tiger-tec® Silver**
Tool: G1111.2525R-5T12-040GX24

Cutting data	Competition CVD	Tiger-tec® Silver WKP23S
v_c	250 m/min	250 m/min
f	0.15 mm	0.20 mm
Cutting depth	4 mm	4 mm
Tool life	300 components	400 components
Machining time	36 secs	30 secs -20%

Note:
Excellent chip breaking thanks to UD4 geometry.
High level of process reliability

Comparison of the number of components

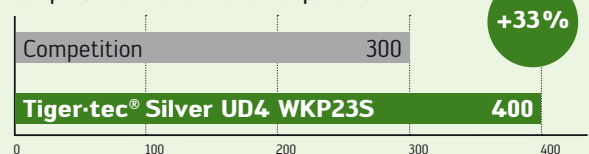

Watch product video:
Scan this QR code or go directly to
<http://goo.gl/dcyLLa>

Walter Cut

GX and SX geometries for parting off.

THE GEOMETRIES

CF6 – The sharp one

- Extremely low burr and pip formation
- Right- and left-hand inserts available for parting off
- For small diameters and thin-walled tubes
- 15°, 7° and 6° angled parting off inserts for parting off with low burr and pip formation

CF5 – The positive one

- Low burr and pip formation
- Right- and left-hand inserts available for parting off
- For long-chipping workpiece materials
- 15°, 7° and 6° angled parting off inserts for parting off with low burr and pip formation

CE4 – The universal one

- Stable cutting edge for maximum feed rates
- Right- and left-hand inserts available
- Excellent chip formation

Fields of application/ geometries

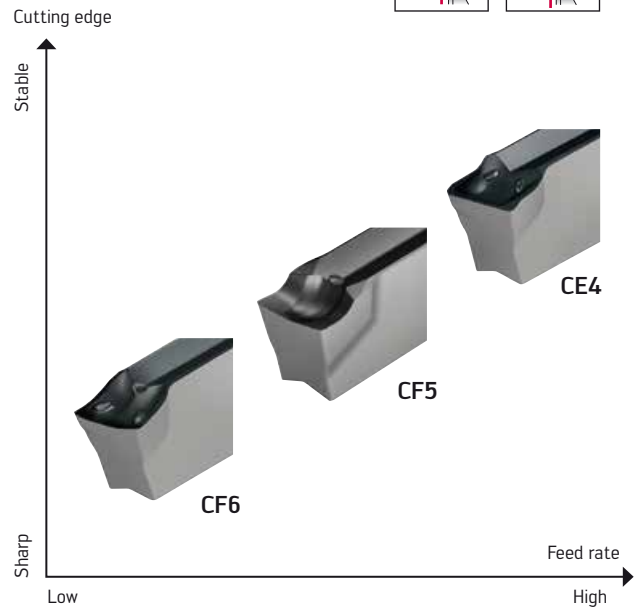

Parting off ball bearing race

Workpiece material: 100Cr6 (1.3505)
Cutting insert: GX16-1E200N020-CE4
Cutting tool material: WSM33S – Tiger-tec® Silver
Tool: G1011.2020L-2T8GX16

Cutting data

	Competition	Tiger-tec®	Tiger-tec® Silver
v_c	150 m/min	150 m/min	170 m/min
f	0.08 mm	0.1 mm	0.1 mm
Cutting depth	8 mm	8 mm	8 mm
Tool life	450 components	800 components	950 components

Note:

- More consistent tool life
- Improved flatness of parted surfaces
- Outstanding chip control

Comparison of the number of components

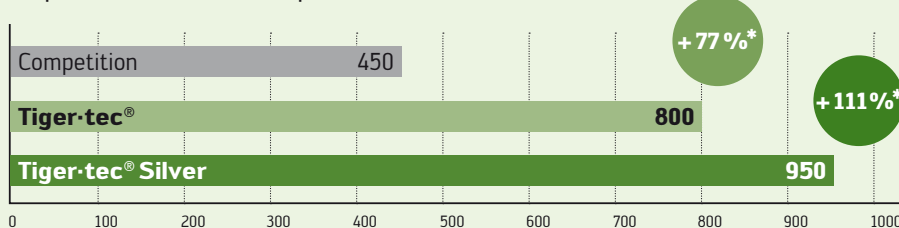

* in comparison to the competition

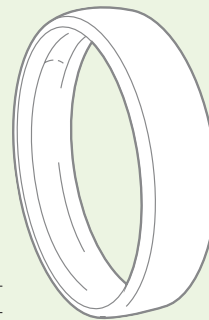

YOUR ADVANTAGES

- Three geometries to cover all machining operations
- Max. tool life thanks to the new PVD Tiger-tec® Silver cutting tool materials



Watch product video:
Scan this QR code or go directly to
<http://goo.gl/e8wZy>

Walter Cut GX geometries for grooving.

THE GEOMETRIES

GD3

- Extremely soft cutting action
- Light to moderate feed rates
- General parting off and grooving operations

GD6

- Moderate feed rates
- Long-chipping materials
- Medium machining conditions

YOUR ADVANTAGES

- Soft cutting action and perfect chip control, even for materials with difficult cutting properties
- Can be used for grooving and parting off

Fields of application/geometries

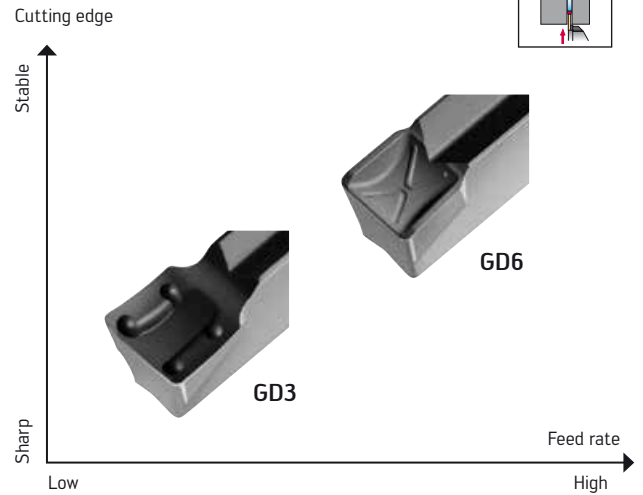

Piston grooving – automotive industry

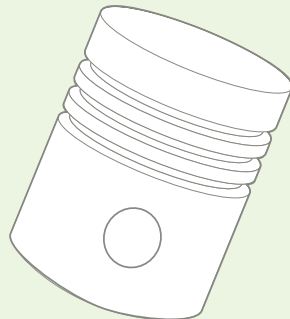

Workpiece material: 42CrMo4 (1.7225)
 Tensile strength: 900 N/mm²
 Cutting insert: GX16-3E400N040-GD3
 Cutting tool material: WKP23S – Tiger-tec® Silver
 Tool: NCAI32-3215R-GX16-3

Cutting data	Competition ISO P	Tiger-tec® Silver WSM33S
v _c	140 m/min	140 m/min
f	0.15 mm	0.15 mm
Cutting depth	4 mm	4 mm
Tool life	145 components	200 components

Comparison of the number of components

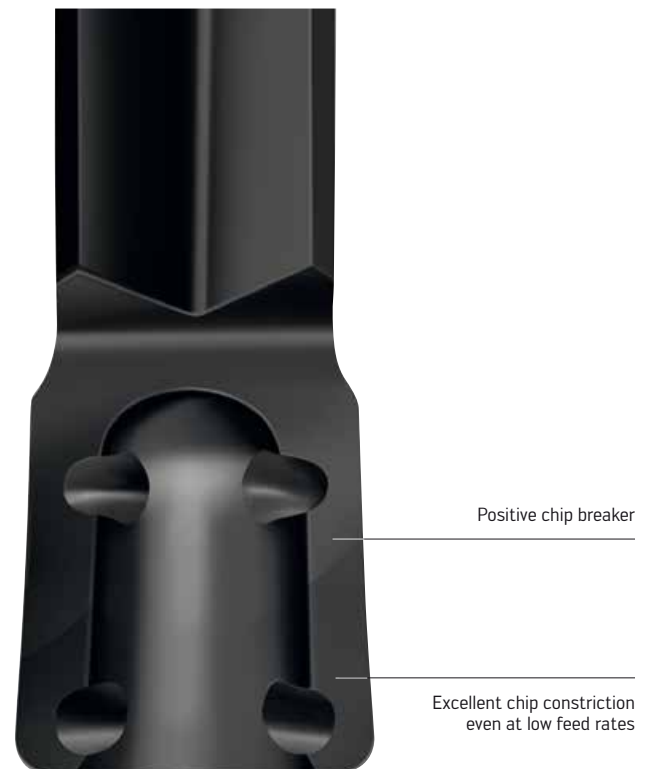
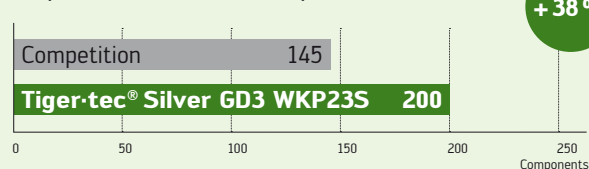

Grooving chip breaker

Type: GD3

Walter Cut

GX universal geometries for grooving and longitudinal turning.

THE GEOMETRIES

UD6

- Grooving in rust-resistant steel
- Average feed range
- Soft cutting action

UF4

- All grooving operations
- Good chip control
- Average feed range
- Positive cut

UD4

- Large chip breaking area
- Optimised chip breaking when machining forged parts
- Stable cutting edge
- For moderate to high feed rates

UA4

- For cast iron machining
- For moderate to high feed rates
- Maximum stability

Fields of application/geometries

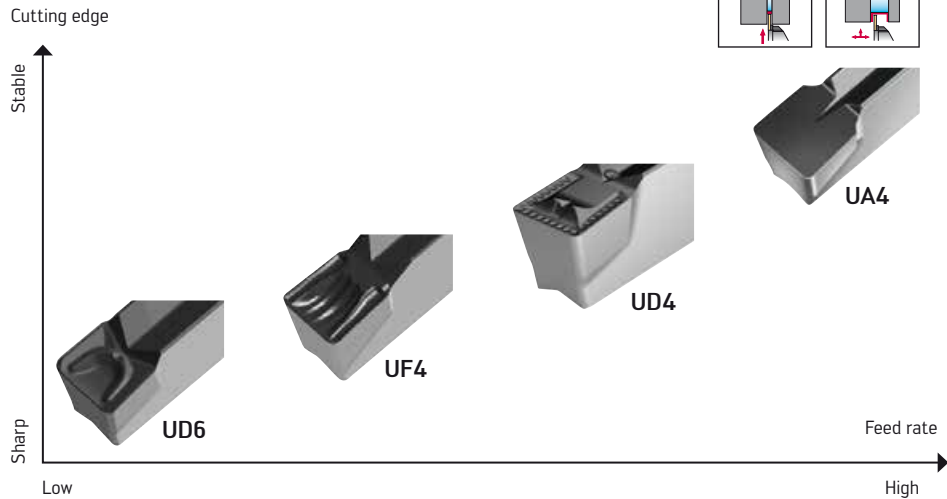

Watch product video:
Scan this QR code
or go directly to
<http://goo.gl/0c0xB>

YOUR ADVANTAGES

- Increased tool life thanks to PVD and CVD **Tiger-tec® Silver** cutting tool materials
- Universal chip breaker, suitable for all machining

Axial grooving of hub – automotive industry

Workpiece material: 16MnCr5 (1.71315)
Tensile strength: 600 N/mm²
Cutting insert: GX24-4E600N05-UD4
Cutting tool material: WSM33S – **Tiger-tec® Silver**
Tool: G1521.2525L-T6GX24

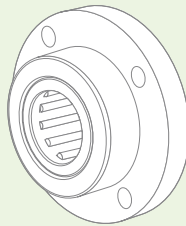

Cutting data	Competition ISO P	Tiger-tec® Silver WSM33S
v_c	240–350 m/min	240–350 m/min
f	0.1–0.3 mm	0.2–0.3 mm
a_p	1.0–1.5 mm	1.0–1.5 mm
Tool life	150 components	270 components

Note:
Excellent chip breaking with the UD4 geometry. High process reliability.

Comparison of the number of components

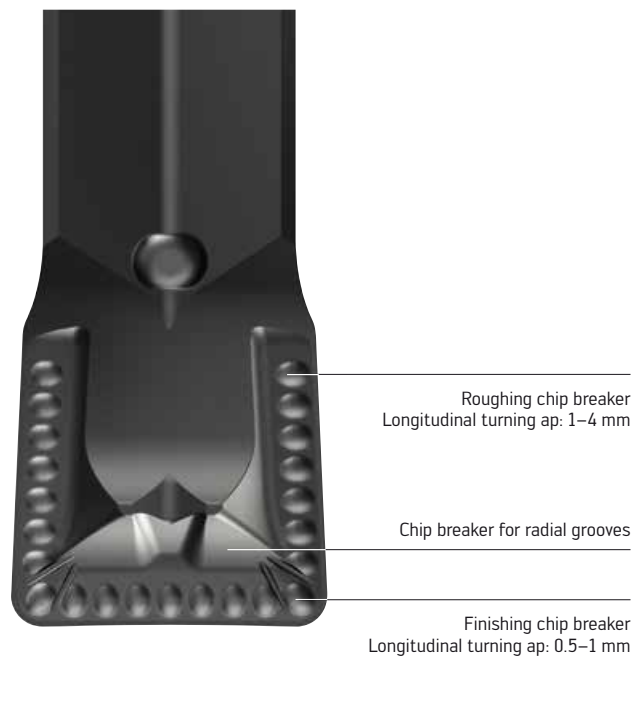
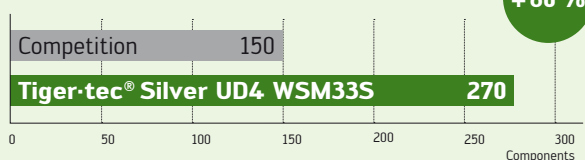

Universal geometry

Type: UD4

Walter CUT

GX geometries for copy turning.

THE GEOMETRIES

RF8

- For copy and relief turning
- High surface quality
- Machining of ISO M, ISO N and ISO S materials, such as turbine discs
- 230° machining angle enables undercuts to be created
- Finishing of ISO P materials
- Reduced cutting forces due to positive cutting edges with a fully ground circumference

RD4

- For copy turning, e.g. of forged parts
- Outstanding chip control even at low cutting depths
- For moderate to high feed rates
- Stable cutting edge, fully sintered
- Machining of ISO P / ISO K

Fields of application/geometries

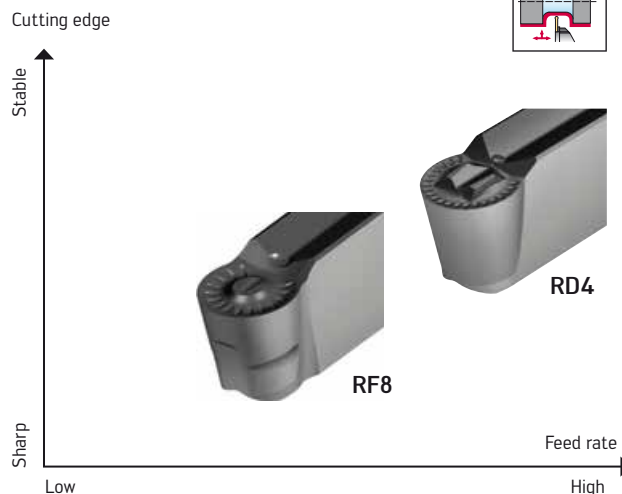

Gearwheel axial grooving

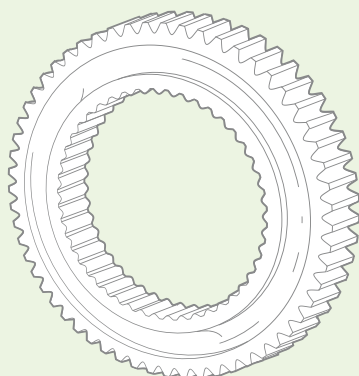

Workpiece material: 16MnCr5 (1.7131)
 Cutting insert: GX24-3E400N200-RD4
 Cutting tool material: WKP23S – Tiger-tec® Silver
 Tool: G1111.2525L-4T20GX24

Cutting data

	Competition	Tiger-tec® Silver
v_c	180 m/min	200 m/min
f	0.12 mm	0.20 mm
Cutting depth	7 mm	7 mm
Tool life	400 components	600 components

Note:

- Outstanding chip control
- Shorter process time due to higher feed rate and faster cutting speed
- Greater process reliability

Comparison of the number of components

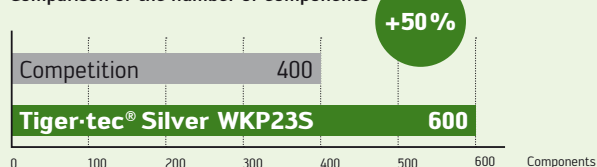

YOUR ADVANTAGES

- Increased tool life thanks to PVD and CVD Tiger-tec® Silver cutting tool materials
- Outstanding chip control for any machining operation



Double geometry enables chip breaking for grooving operations and when copy turning

Stable cutting edge for longer tool life and greater process reliability









Full-radius geometry

Type: RD4

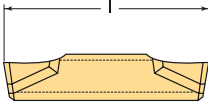
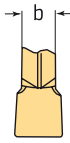
Designation key for cutting inserts

Example

GX 24	—	2 E 300 N 03	—	U F 4					
1		3	4	5	6	7	8	9	10

1	2	3	4
Insert type	Insert length l [mm]	Width category	Basic shape
<p>GX</p>  <p>SX</p> 	 <p>09 l = 9</p> <p>16 l = 16</p> <p>24 l = 24</p> <p>30 l = 30</p>	 <p>0</p> <p>1</p> <p>2</p> <p>3</p> <p>4</p> <p>5</p>	<p>E</p>   <p>F</p>  <p>R</p>  <p>S</p> 

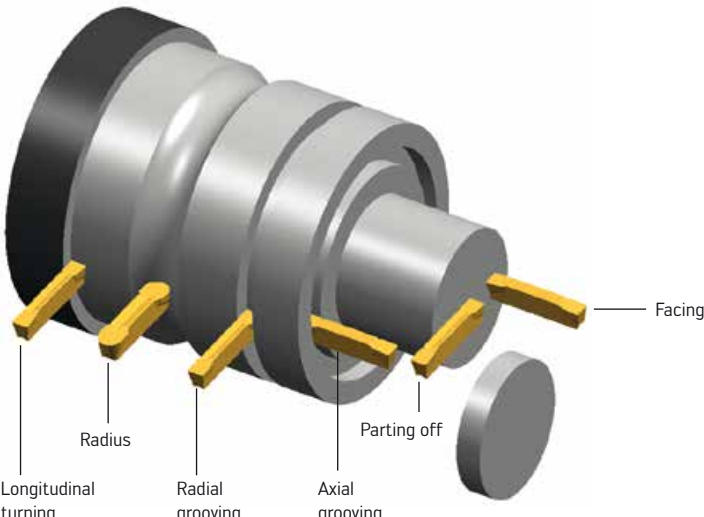
8	
Application	
<p>C "Cut off"</p> <ul style="list-style-type: none"> – Parting off – Radial grooving <p>G "Grooving"</p> <ul style="list-style-type: none"> – Radial grooving – Axial grooving – Parting off <p>R Full radius</p> <ul style="list-style-type: none"> – Radial grooving – Axial grooving – Longitudinal turning – Facing <p>U Universal</p> <ul style="list-style-type: none"> – Longitudinal turning – Radial grooving – Axial grooving – Facing – Parting off 	

5

Insert width s [mm]

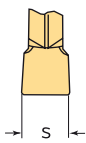



for example:

200	$s = 2.0$
220	$s = 2.2$
250	$s = 2.5$
300	$s = 3.0$
310	$s = 3.1$
etc.	



6

Version

Grooving:

R		Right
L		Left
N		Neutral

Parting off:

R		Right
L		Left

7

Corner radius r [mm]/
clearance angle χ [°]

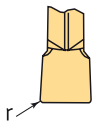

02	$r = 0.2$
03	$r = 0.3$
04	$r = 0.4$
05	$r = 0.5$
etc.	

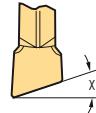





6	$\chi = 6^\circ$
7	$\chi = 7^\circ$
15	$\chi = 15^\circ$
etc.	

9

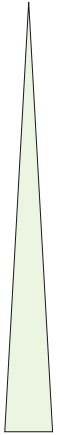
Rake angle

Smaller







		A
		D
		F
		K

Larger

10

Cutting edge

Stable

		1
		3
		4
		6
		8

Sharp



Walter Select for parting off inserts

Step by step to the right cutting insert

STEP 1

Determine the **material** to be machined from page H 8 in the Walter General catalogue 2012.

Make a note of the machining group corresponding to your material e.g.: P10.

Identification letters	Machining group	Groups of the materials to be machined	
P	P1–P15	Steel	All types of steel and cast steel, with the exception of steel with an austenitic structure
M	M1–M3	Stainless steel	Austenitic stainless steel, austenitic-ferritic steel and cast steel
K	K1–K7	Cast iron	Grey cast iron, cast iron with spheroidal graphite, malleable cast iron, cast iron with vermicular graphite
N	N1–N10	NF metals	Aluminium and other non-ferrous metals, non-ferrous materials
S	S1–S10	High temperature alloys and titanium alloys	Heat-resistant special alloys based on iron, nickel and cobalt, titanium and titanium alloys
H	H1–H4	Hard materials	Hardened steel, hardened cast iron materials, chilled cast iron
O	O1–O6	Other	Plastics, glass and carbon-fibre reinforced plastics, graphite

STEP 2

Determine the **basic shape** of the cutting insert:

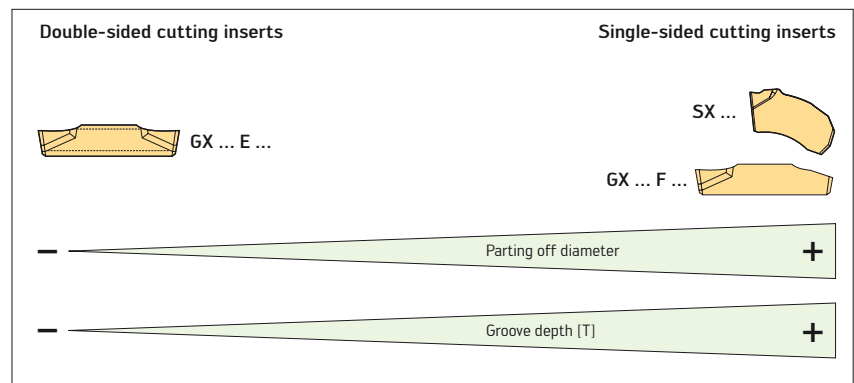

STEP 3

Select the **machining conditions**:

Type of cutting action	Machine stability, clamping system and workpiece		
	Very good	Good	Moderate
Smooth cut Parting off tubing.	☺	☹	☹
Smooth cut Parting solid bar to centre	☹	☹	
Interrupted cuts	☹	☹	☹

STEP 4

Determine the **indexable insert geometry** using cutting edge stability and feed.



GX and SX cutting inserts for parting off

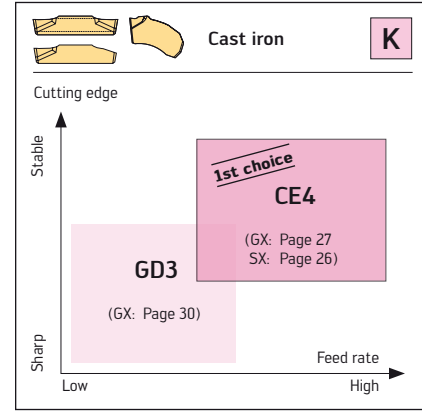
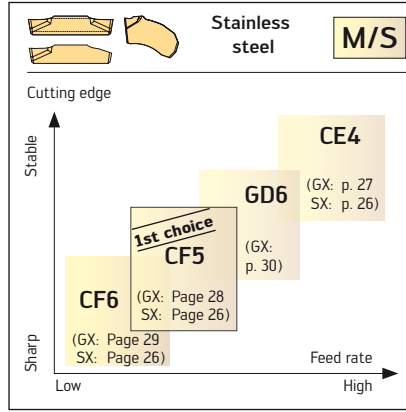
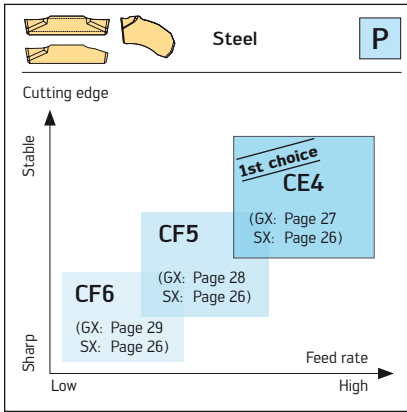

GX inserts for grooving

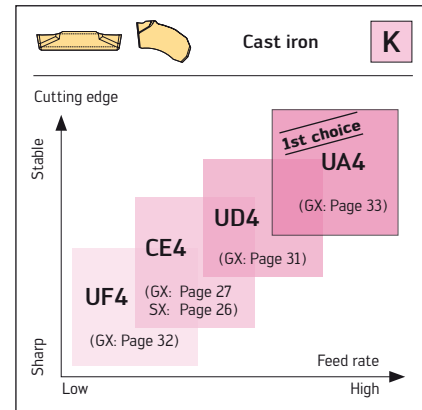
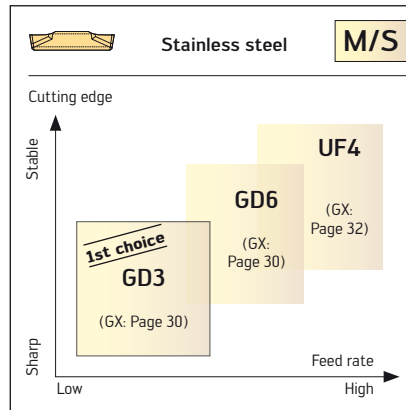
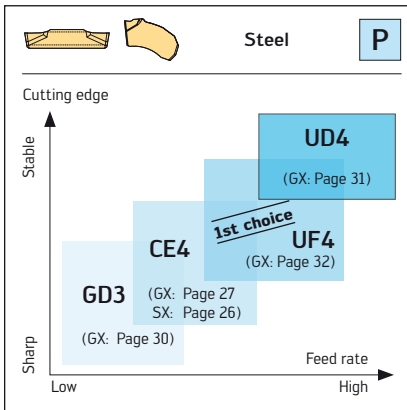

Geometry selection for groove turning

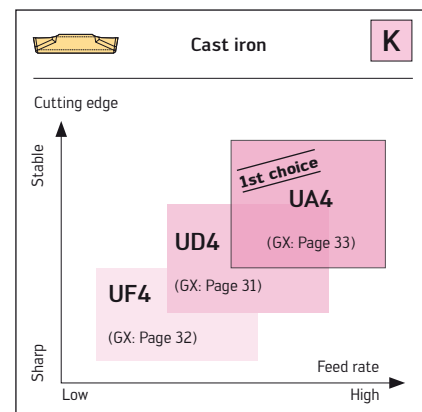
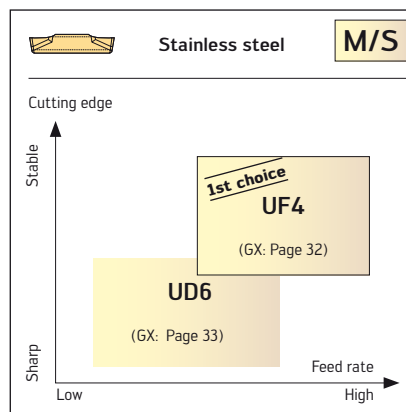
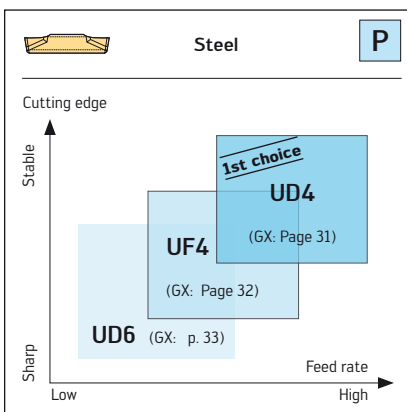

STEP 4 – Continued

Determine the indexable insert geometry using cutting edge stability and feed.



Selecting a geometry for copy turning

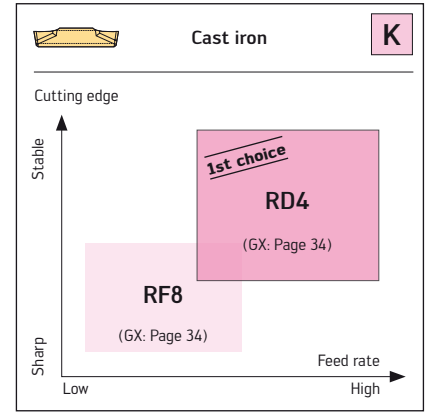
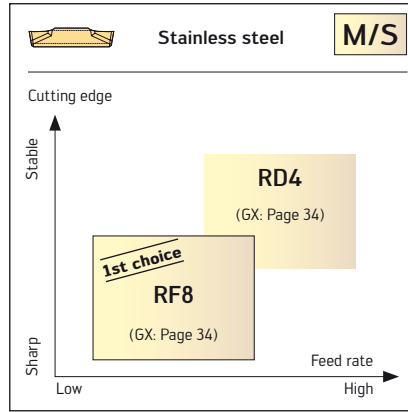
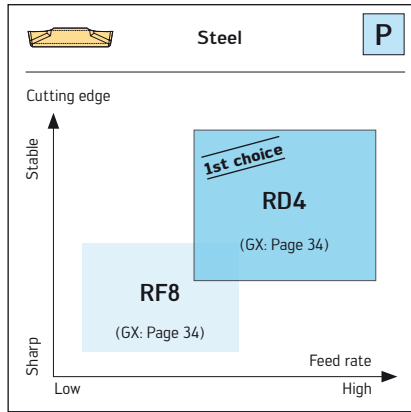

STEP 5

You will find the cutting tool material recommendation and the feed value (f) on the specified catalogue page.

Walter Cut GX grooving inserts
Grooving and parting off
Tiger-tec® Silver

Indexable inserts

Designation	s mm	r mm	k	l mm	f mm	Stol mm	fTot mm	P	HC	M	HC	K	HC
GX16-1E200N02-CF5	2	0.2		16.6	0.04 - 0.12	±0.05	±0.15	WPP23	WSM235	WSM335	WSM435	WSM235	WSM335
GX16-1E200R/L6-CF5	2	0.2	6°	16.6	0.03 - 0.10	±0.05	±0.15						
GX16-1E200R/L7-CF5	2		7°	16.2	0.03 - 0.10	±0.05	±0.15						
GX16-1E200R/L15-CF5	2		15°	16.2	0.03 - 0.10	±0.05	±0.15						

WALTER SELECT

Best insert for:

☺ good ☹ moderate ☹ unfavourable

machining conditions

STEP 6

Choose the **cutting data** for your selected cutting insert from the technical information from page 56 onwards.

Cutting data for Walter Cut – Parting off
Carbide grades

☹ = Cutting data for wet machining
☹☹ = Dry machining is possible

Material group	Structure of main material groups and identification letters	Brinell hardness HB	Tensile strength R _m N/mm ²	Machining group 1
P	Unalloyed steel			
	C ≤ 0.25%	125	428	P1 ●●
	C > 0.25 < 0.55%	190	639	P2 ●●
	C > 0.25 < 0.55%	210	708	P3 ●●
	C > 0.55%	190	639	P4 ●●
	C > 0.55%	300	1013	P5 ●●
Low-alloyed steel	Free cutting steel (short-chipping)	220	745	P6 ●●
	annealed	175	591	P7 ●●
	tempered	300	1013	P8 ●●



Walter Cut SX grooving inserts

Grooving and parting off

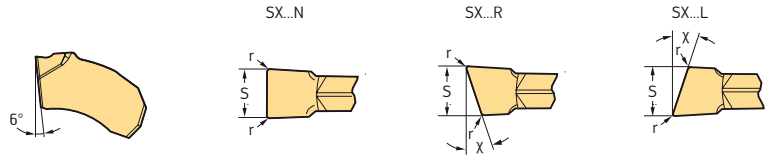
Tiger-tec® Silver



Indexable inserts

Designation	s mm	r mm	κ	f mm	s _{Tol} mm	l _{Tol} mm	P				M		S	
							HC				HC		HC	
							WKP23S	WSM23S	WSM33S	WSM43S	WSM23S	WSM43S	WKP23S	WSM23S
 SX-1E150N01-CE4*	1,5	0,1		0,03 - 0,12	±0,05	±0,1		☉	☉	☉	☉		☉	☉
SX-1E15R/L6-CE4*	1,5	0,1	6°	0,03 - 0,08	±0,05	±0,1		☉	☉	☉	☉		☉	☉
SX-2E200N02-CE4	2	0,2		0,06 - 0,15	±0,05	±0,1	☉	☉	☉	☉	☉		☉	☉
SX-2E200R/L6-CE4*	2	0,2	6°	0,06 - 0,10	±0,05	±0,1		☉	☉	☉	☉		☉	☉
SX-3E300N02-CE4	3	0,2		0,09 - 0,30	±0,05	±0,1	☉	☉	☉	☉	☉		☉	☉
SX-3E300R/L6-CE4*	3	0,2	6°	0,06 - 0,20	±0,05	±0,1		☉	☉	☉	☉		☉	☉
SX-4E400N02-CE4	4	0,2		0,10 - 0,32	±0,05	±0,1	☉	☉	☉	☉	☉		☉	☉
SX-4E400R/L6-CE4*	4	0,2	6°	0,08 - 0,22	±0,05	±0,1		☉	☉	☉	☉		☉	☉
SX-5E500N04-CE4	5	0,4		0,12 - 0,35	±0,05	±0,1	☉	☉	☉	☉	☉		☉	☉
SX-5E500R/L6-CE4*	5	0,4	6°	0,10 - 0,25	±0,05	±0,1		☉	☉	☉	☉		☉	☉
SX-6E600N04-CE4	6	0,4		0,12 - 0,40	±0,05	±0,1	☉	☉	☉	☉	☉		☉	☉
SX-6E600R/L6-CE4*	6	0,4	6°	0,12 - 0,30	±0,05	±0,1		☉	☉	☉	☉		☉	☉
 SX-1E150N01-CF5*	1,5	0,1		0,03 - 0,10	±0,05	±0,1		☉	☉	☉	☉		☉	☉
SX-1E150R/L6-CF5*	1,5	0,1	6°	0,03 - 0,08	±0,05	±0,1		☉	☉	☉	☉		☉	☉
SX-1E150R/L7-CF5*	1,5		7°	0,03 - 0,08	±0,02	±0,1		☉	☉	☉	☉		☉	☉
SX-1E150R/L15-CF5*	1,5		15°	0,03 - 0,08	±0,02	±0,1		☉	☉	☉	☉		☉	☉
SX-2E200N02-CF5	2	0,2		0,04 - 0,12	±0,05	±0,1		☉	☉	☉	☉		☉	☉
SX-2E200R/L6-CF5*	2	0,2	6°	0,03 - 0,10	±0,05	±0,1		☉	☉	☉	☉		☉	☉
SX-2E200R/L7-CF5*	2		7°	0,03 - 0,10	±0,02	±0,1		☉	☉	☉	☉		☉	☉
SX-2E200R/L15-CF5*	2		15°	0,03 - 0,10	±0,02	±0,1		☉	☉	☉	☉		☉	☉
SX-3E300N02-CF5	3	0,2		0,08 - 0,20	±0,05	±0,1		☉	☉	☉	☉		☉	☉
SX-3E300R/L6-CF5*	3	0,2	6°	0,04 - 0,16	±0,05	±0,1		☉	☉	☉	☉		☉	☉
SX-3E300R/L7-CF5*	3		7°	0,04 - 0,13	±0,02	±0,1		☉	☉	☉	☉		☉	☉
SX-3E300R/L15-CF5*	3		15°	0,04 - 0,13	±0,02	±0,1		☉	☉	☉	☉		☉	☉
SX-4E400N02-CF5	4	0,2		0,10 - 0,22	±0,05	±0,1		☉	☉	☉	☉		☉	☉
SX-4E400R/L6-CF5*	4	0,2	6°	0,08 - 0,18	±0,05	±0,1		☉	☉	☉	☉		☉	☉
SX-5E500N04-CF5	5	0,4		0,10 - 0,25	±0,05	±0,1		☉	☉	☉	☉		☉	☉
SX-5E500R/L6-CF5*	5	0,4	6°	0,10 - 0,20	±0,05	±0,1		☉	☉	☉	☉		☉	☉
SX-6E600N04-CF5	6	0,4		0,10 - 0,30	±0,05	±0,1		☉	☉	☉	☉		☉	☉
 SX-1E150N01-CF6*	1,5	0,1		0,03 - 0,10	±0,05	±0,1		☉	☉	☉	☉		☉	☉
SX-2E200N02-CF6	2	0,2		0,03 - 0,12	±0,05	±0,1		☉	☉	☉	☉		☉	☉
SX-3E300N02-CF6	3	0,2		0,04 - 0,20	±0,05	±0,1		☉	☉	☉	☉		☉	☉

l_{Tol} = Repeat accuracy when changing indexable insert

Radius tolerance r_{Tol} = ±0.05

* available from Q4/2014

HC = Coated carbide



Walter Cut GX grooving inserts

Grooving and parting off

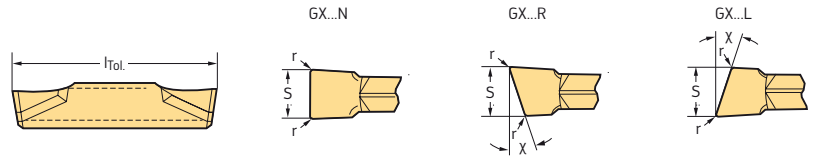
Tiger-tec® Silver



Indexable inserts

Designation	s mm	r mm	κ	l mm	f mm	s _{Tol} mm	l _{Tol} mm	P				M			K	S		
								HC				HC			HC	HC		
								WKP23S	WSM23S	WSM33S	WSM43S	WSM23S	WSM33S	WSM43S	WKP23S	WSM23S	WSM33S	WSM43S
 GX16-1E200N02-CE4	2	0,2		16,6	0,06 - 0,15	±0,05	±0,15		☺	☺	☺	☺	☺			☺	☺	
GX16-1E200R/L6-CE4	2	0,2	6°	16,6	0,04 - 0,10	±0,05	±0,15		☺	☺	☺	☺	☺			☺	☺	
GX16-1E250N02-CE4	2,5	0,2		16,6	0,07 - 0,18	±0,05	±0,15		☺	☺	☺	☺	☺			☺	☺	
GX16-1E250R/L6-CE4	2,5	0,2	6°	16,6	0,05 - 0,12	±0,05	±0,15		☺	☺	☺	☺	☺			☺	☺	
GX16-2E300N02-CE4	3	0,2		16,6	0,09 - 0,30	±0,05	±0,15		☺	☺	☺	☺	☺			☺	☺	
GX16-2E300R/L6-CE4	3	0,2	6°	16,6	0,09 - 0,24	±0,05	±0,15		☺	☺	☺	☺	☺			☺	☺	
GX24-1E200N02-CE4*	2	0,2		24	0,06 - 0,15	±0,05	±0,15		☺	☺	☺	☺	☺			☺	☺	
GX24-1E250N02-CE4	2,5	0,2		24	0,07 - 0,18	±0,05	±0,15		☺	☺	☺	☺	☺			☺	☺	
GX24-2E300N02-CE4	3	0,2		24	0,09 - 0,30	±0,05	±0,15	☺	☺	☺	☺	☺	☺			☺	☺	
GX24-2E300R/L6-CE4	3	0,2	6°	24,6	0,09 - 0,24	±0,05	±0,15	☺	☺	☺	☺	☺	☺			☺	☺	
GX24-3E400N03-CE4	4	0,3		24	0,10 - 0,32	±0,05	±0,15	☺	☺	☺	☺	☺	☺			☺	☺	
GX24-3E400R/L6-CE4	4	0,2	6°	24,6	0,10 - 0,26	±0,05	±0,15		☺	☺	☺	☺	☺			☺	☺	
GX24-3E500N03-CE4	5	0,3		24	0,12 - 0,35	±0,05	±0,15	☺	☺	☺	☺	☺	☺			☺	☺	
GX24-4E600N03-CE4	6	0,3		24	0,12 - 0,40	±0,05	±0,15	☺	☺	☺	☺	☺	☺			☺	☺	
 GX16-1F200N02-CE4	2	0,2		16	0,04 - 0,12	±0,05	±0,15		☺	☺	☺	☺	☺			☺	☺	
GX16-1F250N02-CE4	2,5	0,2		16	0,05 - 0,15	±0,05	±0,15		☺	☺	☺	☺	☺			☺	☺	
GX24-2F300N02-CE4	3	0,2		24	0,09 - 0,30	±0,05	±0,15		☺	☺	☺	☺	☺			☺	☺	
GX24-3F400N03-CE4	4	0,3		24	0,10 - 0,32	±0,05	±0,15		☺	☺	☺	☺	☺			☺	☺	

l_{Tol} = Repeat accuracy when changing indexable insert

Radius tolerance r_{Tol} = ±0.05

Parting off diameters up to 32 mm possible with these inserts (l = 16.6 mm).

* available from Q4/2014

HC = Coated carbide

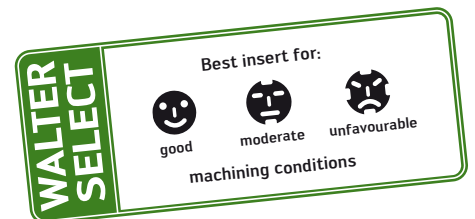



Walter Cut GX grooving inserts

Grooving and parting off

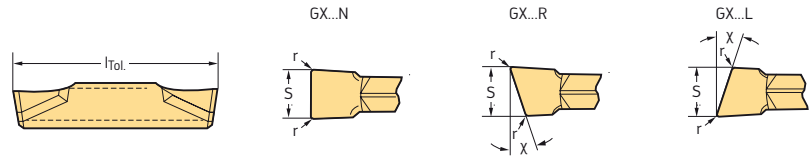
Tiger-tec® Silver



Indexable inserts

Designation	s mm	r mm	κ	l mm	f mm	S _{Tol} mm	l _{Tol} mm	P				M		K	S	
								HC				HC		HC	HC	
								WKP23S	WSM23S	WSM33S	WSM43S	WSM23S	WSM33S	WSM43S	WKP23S	WSM23S
 GX16-1E200N02-CF5	2	0,2		16,6	0,04 - 0,12	±0,05	±0,15		☑	☑		☑			☑	☑
GX16-1E200R/L6-CF5	2	0,2	6°	16,6	0,03 - 0,10	±0,05	±0,15		☑	☑	☑	☑			☑	☑
GX16-1E200R/L7-CF5	2		7°	16,2	0,03 - 0,10	±0,02	±0,15		☑		☑				☑	
GX16-1E200R/L15-CF5	2		15°	16,2	0,03 - 0,10	±0,02	±0,15		☑		☑				☑	
GX16-1E250N02-CF5	2,5	0,2		16,6	0,05 - 0,15	±0,05	±0,15		☑	☑	☑	☑			☑	☑
GX16-1E250R/L6-CF5	2,5	0,2	6°	16,6	0,03 - 0,12	±0,05	±0,15		☑	☑	☑	☑			☑	☑
GX16-2E300N02-CF5	3	0,2		16,6	0,08 - 0,20	±0,05	±0,15		☑	☑	☑	☑			☑	☑
GX16-2E300R/L6-CF5	3	0,2	6°	16,6	0,04 - 0,16	±0,05	±0,15		☑	☑	☑	☑			☑	☑
GX16-2E300R/L7-CF5	3		7°	16,2	0,04 - 0,13	±0,02	±0,15		☑		☑				☑	
GX16-2E300R/L15-CF5	3		15°	16,2	0,04 - 0,13	±0,02	±0,15		☑		☑				☑	
GX24-1E200N02-CF5*	2	0,2		24	0,04 - 0,12	±0,05	±0,15		☑	☑	☑	☑			☑	☑
GX24-1E250N02-CF5*	2,5	0,2		24	0,05 - 0,15	±0,05	±0,15		☑	☑	☑	☑			☑	☑
GX24-2E300N02-CF5	3	0,2		24	0,08 - 0,20	±0,05	±0,15		☑	☑	☑	☑			☑	☑
GX24-2E300R/L6-CF5	3	0,2	6°	24,6	0,04 - 0,16	±0,05	±0,15		☑	☑	☑	☑			☑	☑
GX24-3E400N02-CF5	4	0,2		24	0,10 - 0,22	±0,05	±0,15		☑	☑	☑	☑			☑	☑
GX24-3E400R/L6-CF5	4	0,2	6°	24,6	0,10 - 0,18	±0,05	±0,15		☑	☑	☑	☑			☑	☑
GX24-3E500N03-CF5	5	0,3		24	0,10 - 0,25	±0,05	±0,15		☑	☑	☑	☑			☑	☑
 GX16-1F200N02-CF5	2	0,2		16	0,03 - 0,12	±0,05	±0,15		☑	☑	☑	☑			☑	☑
GX16-1F250N02-CF5	2,5	0,2		16	0,03 - 0,15	±0,05	±0,15		☑	☑	☑	☑			☑	☑
GX24-2F300N02-CF5	3	0,2		23,7	0,04 - 0,20	±0,05	±0,15		☑	☑	☑	☑			☑	☑
GX24-3F400N02-CF5	4	0,2		23,7	0,10 - 0,22	±0,05	±0,15		☑	☑	☑	☑			☑	☑
GX24-3F500N03-CF5	5	0,3		23,7	0,10 - 0,25	±0,05	±0,15		☑	☑	☑	☑			☑	☑

l_{Tol} = Repeat accuracy when changing indexable insert

Radius tolerance r_{Tol} = ±0.05

Parting off diameters up to 32 mm possible with these inserts (l = 16.6 mm).



* available from Q4/2014

HC = Coated carbide

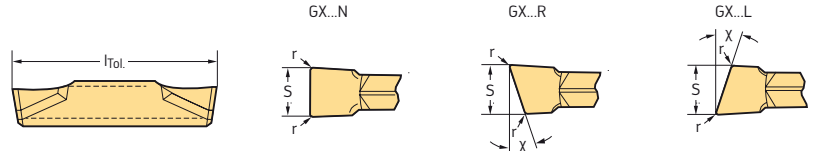
Walter Cut GX grooving inserts
Grooving and parting off
Tiger-tec® Silver



Indexable inserts

Designation	s mm	r mm	κ	l mm	f mm	s _{Tol} mm	l _{Tol} mm	P			M			K	S		
								HC			HC			HC	HC		
								WKP23S	WSM23S	WSM33S	WSM43S	WSP23S	WSM23S	WSM33S	WSM43S	WKP23S	WSM23S
 GX16-0E150N01-CF6	1,5	0,15		16,6	0,03 - 0,10	±0,02	±0,05		☺	☺	☺				☺	☺	
GX16-0E150R/L10-CF6	1,5	0,15	10°	16,6	0,03 - 0,10	±0,02	±0,05		☺		☺				☺		
GX16-1E200N02-CF6	2	0,2		16,6	0,03 - 0,12	±0,05	±0,15		☺	☺	☺				☺	☺	
GX16-1E200R/L6-CF6	2	0,2	6°	16,6	0,03 - 0,10	±0,05	±0,15		☺	☺	☺				☺	☺	
GX16-1E200R/L7-CF6	2		7°	16,2	0,03 - 0,10	±0,02	±0,15		☺		☺				☺		
GX16-1E200R/L15-CF6	2		15°	16,2	0,03 - 0,10	±0,02	±0,15		☺		☺				☺		
GX16-1E250N02-CF6	2,5	0,2		16,6	0,03 - 0,15	±0,05	±0,15		☺	☺	☺				☺	☺	
GX16-1E250R/L6-CF6	2,5	0,2	6°	16,6	0,03 - 0,12	±0,05	±0,15		☺	☺	☺				☺	☺	
GX16-2E300N02-CF6	3	0,2		16,6	0,04 - 0,20	±0,05	±0,15		☺	☺	☺				☺	☺	
GX16-2E300R/L6-CF6	3	0,2	6°	16,6	0,04 - 0,16	±0,05	±0,15		☺	☺	☺				☺	☺	
GX16-2E300R/L7-CF6	3		7°	16,2	0,04 - 0,13	±0,02	±0,15		☺		☺				☺		
GX16-2E300R/L15-CF6	3		15°	16,2	0,04 - 0,13	±0,02	±0,15		☺		☺				☺		
GX24-1E200N02-CF6*	2	0,2		24	0,03 - 0,12	±0,05	±0,15		☺	☺	☺				☺	☺	
GX24-1E250N02-CF6*	2,5	0,2		24	0,03 - 0,15	±0,05	±0,15		☺	☺	☺				☺	☺	
GX24-2E300N02-CF6	3	0,2		24,6	0,04 - 0,20	±0,05	±0,15		☺	☺	☺				☺	☺	
GX24-2E300R/L6-CF6	3	0,2	6°	24,6	0,04 - 0,16	±0,05	±0,15		☺	☺	☺				☺	☺	
 GX16-1F200N02-CF6	2	0,2		16	0,03 - 0,12	±0,05	±0,15		☺	☺	☺				☺	☺	
GX16-1F250N02-CF6	2,5	0,2		16	0,03 - 0,15	±0,05	±0,15		☺	☺	☺				☺	☺	
GX24-2F300N02-CF6	3	0,2		24	0,04 - 0,20	±0,05	±0,15		☺	☺	☺				☺	☺	

l_{Tol} = Repeat accuracy when changing indexable insert

Radius tolerance r_{Tol} = ±0.05

Parting off diameters up to 32 mm possible with these inserts (l = 16.6 mm).

* available from Q4/2014

HC = Coated carbide

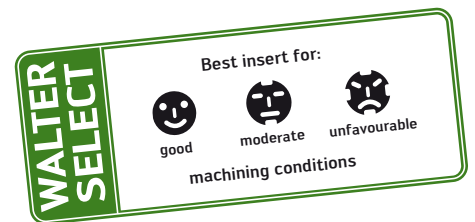



Walter Cut GX grooving inserts

Grooving and parting off

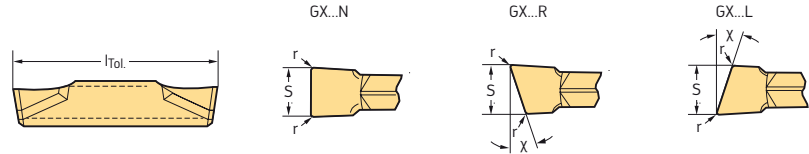
Tiger-tec® Silver



Indexable inserts

Designation	s mm	r mm	k	l mm	f mm	S _{Tol} mm	l _{Tol} mm	P				M		K	S	
								HC				HC		HC	HC	
								WKP23S	WSM23S	WSM33S	WSM43S	WSM23S	WSM33S	WSM43S	WKP23S	WSM23S
 GX09-1E200N02-GD3	2	0,2		9	0,04 - 0,12	±0,02	±0,05	☺	☺	☺	☺	☺	☺	☺	☺	☺
GX09-1E250N02-GD3	2,5	0,2		9	0,04 - 0,14	±0,02	±0,05	☺	☺	☺	☺	☺	☺	☺	☺	☺
GX09-2E300N03-GD3	3	0,3		9	0,06 - 0,18	±0,02	±0,05	☺	☺	☺	☺	☺	☺	☺	☺	☺
GX09-2E350N03-GD3	3,5	0,3		9	0,06 - 0,18	±0,02	±0,05	☺	☺	☺	☺	☺	☺	☺	☺	☺
GX16-1E200N02-GD3	2	0,2		16	0,04 - 0,12	±0,02	±0,05	☺	☺	☺	☺	☺	☺	☺	☺	☺
GX16-1E250N02-GD3	2,5	0,2		16	0,04 - 0,14	±0,02	±0,05	☺	☺	☺	☺	☺	☺	☺	☺	☺
GX16-2E300N03-GD3	3	0,3		16	0,06 - 0,18	±0,02	±0,05	☺	☺	☺	☺	☺	☺	☺	☺	☺
GX16-3E400N04-GD3	4	0,4		16	0,10 - 0,20	±0,02	±0,05	☺	☺	☺	☺	☺	☺	☺	☺	☺
GX16-3E500N04-GD3	5	0,4		16	0,12 - 0,25	±0,02	±0,05	☺	☺	☺	☺	☺	☺	☺	☺	☺
GX16-4E600N05-GD3	6	0,5		16	0,14 - 0,28	±0,02	±0,05	☺	☺	☺	☺	☺	☺	☺	☺	☺
GX24-2E300N03-GD3	3	0,3		24	0,06 - 0,18	±0,05	±0,15	☺	☺	☺	☺	☺	☺	☺	☺	☺
GX24-3E400N04-GD3	4	0,4		24	0,10 - 0,20	±0,05	±0,15	☺	☺	☺	☺	☺	☺	☺	☺	☺
GX24-3E500N04-GD3	5	0,4		24	0,12 - 0,25	±0,05	±0,15	☺	☺	☺	☺	☺	☺	☺	☺	☺
GX24-4E600N05-GD3	6	0,5		24	0,14 - 0,28	±0,05	±0,15	☺	☺	☺	☺	☺	☺	☺	☺	☺
 GX16-1E200N02-GD6	2	0,2		16	0,04 - 0,12	±0,05	±0,15	☺	☺	☺	☺	☺	☺	☺	☺	☺
GX16-1E250N02-GD6	2,5	0,2		16	0,06 - 0,17	±0,05	±0,15	☺	☺	☺	☺	☺	☺	☺	☺	☺
GX16-2E300N03-GD6	3	0,3		16	0,08 - 0,18	±0,05	±0,15	☺	☺	☺	☺	☺	☺	☺	☺	☺
GX16-3E400N04-GD6	4	0,4		16	0,10 - 0,22	±0,05	±0,15	☺	☺	☺	☺	☺	☺	☺	☺	☺
GX16-3E500N04-GD6	5	0,4		16	0,12 - 0,24	±0,05	±0,15	☺	☺	☺	☺	☺	☺	☺	☺	☺
GX16-4E600N05-GD6	6	0,5		16	0,14 - 0,30	±0,05	±0,15	☺	☺	☺	☺	☺	☺	☺	☺	☺
GX24-2E300N03-GD6	3	0,3		24	0,08 - 0,18	±0,05	±0,15	☺	☺	☺	☺	☺	☺	☺	☺	☺
GX24-3E400N04-GD6	4	0,4		24	0,10 - 0,22	±0,05	±0,15	☺	☺	☺	☺	☺	☺	☺	☺	☺
GX24-3E500N04-GD6	5	0,4		24	0,12 - 0,24	±0,05	±0,15	☺	☺	☺	☺	☺	☺	☺	☺	☺
GX24-4E600N05-GD6	6	0,5		24	0,14 - 0,30	±0,05	±0,15	☺	☺	☺	☺	☺	☺	☺	☺	☺

l_{Tol} = Repeat accuracy when changing indexable insert
 Radius tolerance r_{Tol} = ±0.05

HC = Coated carbide

Walter Cut GX grooving inserts

Grooving and longitudinal turning

Tiger-tec® Silver

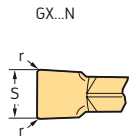
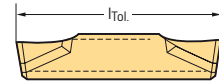

Indexable inserts

Designation	s mm	r mm	l mm	f mm	ap mm	s _{Tol} mm	l _{Tol} mm	P			M			K			S		
								WKP13S	WKP23S	WKP33S	WSM23S	WSM33S	WSM43S	WKP13S	WKP23S	WKP33S	WSM23S	WSM33S	WSM43S
GX16-1E200N02-UD4	2	0,2	16	0,10 - 0,15	0,3 - 1,2	±0,05	±0,15	☺				☺			☺				
GX16-2E300N03-UD4	3	0,3	16	0,10 - 0,20	0,4 - 2,0	±0,05	±0,15	☺				☺			☺				
GX16-3E400N04-UD4	4	0,4	16	0,10 - 0,30	0,5 - 2,8	±0,05	±0,15	☺				☺			☺				
GX16-3E500N04-UD4	5	0,4	16	0,12 - 0,35	0,5 - 3,0	±0,05	±0,15	☺				☺			☺				
GX24-2E300N03-UD4	3	0,3	24	0,10 - 0,20	0,4 - 2,0	±0,05	±0,15	☺	☺	☺		☺		☺	☺	☺			
GX24-2E318N03-UD4*	3,2	0,3	24	0,10 - 0,20	0,4 - 2,0	±0,05	±0,15	☺	☺			☺		☺	☺				
GX24-3E400N04-UD4	4	0,4	24	0,10 - 0,30	0,5 - 2,8	±0,05	±0,15	☺	☺	☺		☺		☺	☺	☺			
GX24-3E400N08-UD4	4	0,8	24	0,10 - 0,30	0,9 - 2,8	±0,05	±0,15	☺	☺	☺		☺		☺	☺	☺			
GX24-3E500N04-UD4	5	0,4	24	0,12 - 0,35	0,5 - 3,0	±0,05	±0,15	☺	☺	☺		☺		☺	☺	☺			
GX24-3E500N08-UD4	5	0,8	24	0,12 - 0,35	0,9 - 3,0	±0,05	±0,15	☺	☺	☺		☺		☺	☺	☺			
GX24-4E600N05-UD4	6	0,5	24	0,14 - 0,40	0,6 - 3,5	±0,05	±0,15	☺	☺	☺		☺		☺	☺	☺			
GX24-4E600N08-UD4	6	0,8	24	0,14 - 0,40	0,9 - 3,5	±0,05	±0,15	☺	☺	☺		☺		☺	☺	☺			
GX30-5E800N08-UD4*	8	0,8	30	0,14 - 0,40	0,9 - 3,5	±0,05	±0,15	☺	☺	☺		☺		☺	☺	☺			
GX30-5E800N12-UD4*	8	1,2	30	0,14 - 0,40	1,0 - 3,5	±0,05	±0,15	☺	☺	☺		☺		☺	☺	☺			

l_{Tol} = Repeat accuracy when changing indexable insert

Radius tolerance r_{Tol} = ±0.05

* available from Q4/2014

HC = Coated carbide

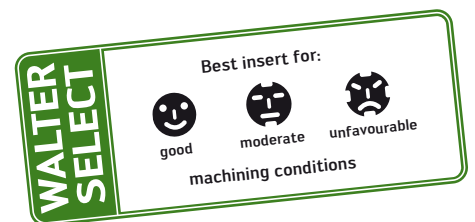

Walter Cut GX grooving inserts

Grooving and longitudinal turning

Tiger-tec® Silver

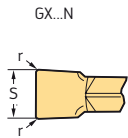
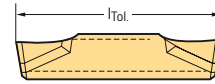

Indexable inserts

Designation	s mm	r mm	l mm	f mm	ap mm	s _{Tol} mm	l _{Tol} mm	P			M			K			S		
								WKP13S	WKP23S	WKP33S	WSM23S	WSM33S	WSM43S	WKP13S	WKP23S	WKP33S	WSM23S	WSM33S	WSM43S
GX09-1E200N02-UF4	2	0,2	9	0,10 - 0,15	0,3 - 1,0	±0,05	±0,15				☺	☺						☺	☺
GX09-2E300N03-UF4	3	0,3	9	0,10 - 0,20	0,4 - 1,5	±0,05	±0,15				☺	☺						☺	☺
GX16-1E200N02-UF4	2	0,2	16	0,10 - 0,15	0,3 - 1,2	±0,05	±0,15	☺			☺	☺			☺			☺	☺
GX16-1E239N02-UF4	2,4	0,2	16	0,10 - 0,18	0,3 - 1,3	±0,05	±0,15				☺	☺						☺	☺
GX16-1E250N02-UF4	2,5	0,2	16	0,10 - 0,18	0,3 - 1,3	±0,05	±0,15	☺			☺	☺			☺			☺	☺
GX16-2E300N03-UF4	3	0,3	16	0,10 - 0,20	0,4 - 2,0	±0,05	±0,15	☺			☺	☺			☺			☺	☺
GX16-3E400N04-UF4	4	0,4	16	0,10 - 0,30	0,5 - 2,8	±0,05	±0,15	☺			☺	☺			☺			☺	☺
GX16-3E500N04-UF4	5	0,4	16	0,12 - 0,35	0,5 - 3,0	±0,05	±0,15	☺			☺	☺			☺			☺	☺
GX16-4E600N05-UF4	6	0,5	16	0,14 - 0,40	0,6 - 3,5	±0,05	±0,15	☺			☺	☺			☺			☺	☺
GX24-2E300N03-UF4	3	0,3	24	0,10 - 0,20	0,4 - 2,0	±0,05	±0,15	☺			☺	☺			☺			☺	☺
GX24-2E318N03-UF4	3,2	0,3	24	0,10 - 0,20	0,4 - 2,0	±0,05	±0,15	☺			☺	☺			☺			☺	☺
GX24-3E400N04-UF4	4	0,4	24	0,10 - 0,30	0,5 - 2,8	±0,05	±0,15	☺			☺	☺			☺			☺	☺
GX24-3E400N08-UF4	4	0,8	24	0,10 - 0,30	0,9 - 2,8	±0,05	±0,15	☺			☺	☺			☺			☺	☺
GX24-3E475N04-UF4	4,8	0,4	24	0,12 - 0,35	0,5 - 3,0	±0,05	±0,15	☺			☺	☺			☺			☺	☺
GX24-3E500N04-UF4	5	0,4	24	0,12 - 0,35	0,5 - 3,0	±0,05	±0,15	☺			☺	☺			☺			☺	☺
GX24-3E500N08-UF4	5	0,8	24	0,12 - 0,35	0,9 - 3,0	±0,05	±0,15	☺			☺	☺			☺			☺	☺
GX24-4E600N05-UF4	6	0,5	24	0,14 - 0,40	0,6 - 3,5	±0,05	±0,15	☺			☺	☺			☺			☺	☺
GX24-4E600N08-UF4	6	0,8	24	0,14 - 0,40	0,8 - 3,5	±0,05	±0,15	☺			☺	☺			☺			☺	☺
GX24-4E635N05-UF4	6,4	0,5	24	0,15 - 0,60	0,6 - 3,5	±0,05	±0,15	☺			☺	☺			☺			☺	☺

l_{Tol} = Repeat accuracy when changing indexable insert
 Radius tolerance r_{Tol} = ±0.05

HC = Coated carbide

Walter Cut GX grooving inserts

Grooving and longitudinal turning

Tiger-tec® Silver

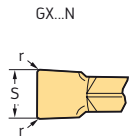
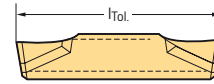

Indexable inserts

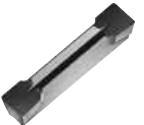
Designation	s mm	r mm	l mm	f mm	ap mm	s _{Tol} mm	l _{Tol} mm	P					M			K		S	
								HC					HC			HC		HC	
								WKP13S	WSM23S	WKP33S	WSM33S	WSM43S	WSM23S	WSM33S	WSM43S	WKP13S	WKP33S	WSM23S	WSM33S
 GX16-1E200N02-UD6	2	0,2	16	0,06 - 0,15	0,3 - 1,2	±0,05	±0,15	☺	☺	☹	☹	☹	☹	☹	☹	☹	☹	☹	☹
GX16-1E250N02-UD6	2,5	0,2	16	0,08 - 0,14	0,3 - 1,3	±0,05	±0,15	☺	☺	☹	☹	☹	☹	☹	☹	☹	☹	☹	☹
GX16-2E300N03-UD6	3	0,3	16	0,10 - 0,20	0,4 - 2,0	±0,05	±0,15	☺	☺	☹	☹	☹	☹	☹	☹	☹	☹	☹	☹
GX16-3E400N04-UD6	4	0,4	16	0,12 - 0,25	0,5 - 2,8	±0,05	±0,15	☺	☺	☹	☹	☹	☹	☹	☹	☹	☹	☹	☹
GX16-3E500N04-UD6	5	0,4	16	0,12 - 0,30	0,5 - 3,0	±0,05	±0,15	☺	☺	☹	☹	☹	☹	☹	☹	☹	☹	☹	☹
GX16-4E600N05-UD6	6	0,5	16	0,14 - 0,35	0,6 - 3,5	±0,05	±0,15	☺	☺	☹	☹	☹	☹	☹	☹	☹	☹	☹	☹
GX24-2E300N03-UD6	3	0,3	24	0,10 - 0,20	0,4 - 2,0	±0,05	±0,15	☺	☺	☹	☹	☹	☹	☹	☹	☹	☹	☹	☹
GX24-3E400N04-UD6	4	0,4	24	0,12 - 0,25	0,5 - 2,8	±0,05	±0,15	☺	☺	☹	☹	☹	☹	☹	☹	☹	☹	☹	☹
GX24-3E500N04-UD6	5	0,4	24	0,12 - 0,30	0,5 - 3,0	±0,05	±0,15	☺	☺	☹	☹	☹	☹	☹	☹	☹	☹	☹	☹
GX24-4E600N05-UD6	6	0,5	24	0,14 - 0,35	0,6 - 3,5	±0,05	±0,15	☺	☺	☹	☹	☹	☹	☹	☹	☹	☹	☹	☹
 GX16-1E200N02-UA4	2	0,2	16	0,08 - 0,15	0,3 - 1,2	±0,05	±0,15	☹	☹	☹	☹	☹	☹	☹	☹	☹	☹	☹	☹
GX16-2E300N03-UA4	3	0,3	16	0,10 - 0,22	0,4 - 2,0	±0,05	±0,15	☹	☹	☹	☹	☹	☹	☹	☹	☹	☹	☹	☹
GX16-3E400N04-UA4	4	0,4	16	0,10 - 0,35	0,5 - 2,8	±0,05	±0,15	☹	☹	☹	☹	☹	☹	☹	☹	☹	☹	☹	☹
GX16-3E500N04-UA4	5	0,4	16	0,12 - 0,35	0,5 - 3,0	±0,05	±0,15	☹	☹	☹	☹	☹	☹	☹	☹	☹	☹	☹	☹
GX16-4E600N05-UA4	6	0,5	16	0,14 - 0,40	0,6 - 3,5	±0,05	±0,15	☹	☹	☹	☹	☹	☹	☹	☹	☹	☹	☹	☹
GX24-2E300N03-UA4	3	0,3	24	0,10 - 0,22	0,4 - 2,0	±0,05	±0,15	☹	☹	☹	☹	☹	☹	☹	☹	☹	☹	☹	☹
GX24-3E400N04-UA4	4	0,4	24	0,10 - 0,35	0,5 - 2,8	±0,05	±0,15	☹	☹	☹	☹	☹	☹	☹	☹	☹	☹	☹	☹
GX24-3E500N04-UA4	5	0,4	24	0,12 - 0,35	0,5 - 3,0	±0,05	±0,15	☹	☹	☹	☹	☹	☹	☹	☹	☹	☹	☹	☹
GX24-4E600N05-UA4	6	0,5	24	0,14 - 0,40	0,6 - 3,5	±0,05	±0,15	☹	☹	☹	☹	☹	☹	☹	☹	☹	☹	☹	☹

l_{Tol} = Repeat accuracy when changing indexable insert
 Radius tolerance r_{Tol} = ±0.05

HC = Coated carbide

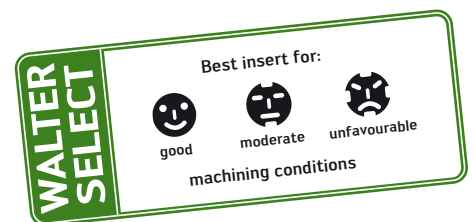



Walter Cut GX grooving inserts

Grooving and longitudinal turning

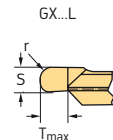
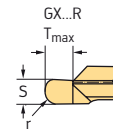
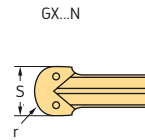
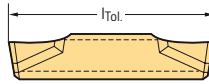
Tiger-tec® Silver



Indexable inserts

Designation	s mm	r mm	l mm	f mm	ap mm	s _{Tol} mm	l _{Tol} mm	P				M				K		N	S		
								HC				HC				HC		HW	HC		
								WKP23S	WSM13S	WSM23S	WSM33S	WSP13S	WSP23S	WSP33S	WSP33	WKP33S	WKP33S	WK1	WSM13S	WSM23S	WSM33S
 GX16-1E200N10-RD4	2	1	16	0,08 - 0,25	0,2 - 1,0	±0,05	±0,15	☺	☺	☺	☺	☺	☺	☺	☺	☺		☺	☺		
GX16-1E239N12-RD4	2,39	1,2	16	0,08 - 0,25	0,2 - 1,0	±0,05	±0,15	☺	☺	☺	☺	☺	☺	☺	☺	☺		☺	☺		
GX24-2E300N15-RD4	3	1,5	24	0,10 - 0,35	0,5 - 1,5	±0,05	±0,15	☺	☺	☺	☺	☺	☺	☺	☺	☺		☺	☺		
GX24-2E318N16-RD4	3,18	1,59	24	0,08 - 0,35	1,6	±0,05	±0,15	☺	☺	☺	☺	☺	☺	☺	☺	☺		☺	☺		
GX24-3E400N20-RD4	4	2	24	0,15 - 0,50	0,5 - 2,0	±0,05	±0,15	☺	☺	☺	☺	☺	☺	☺	☺	☺		☺	☺		
GX24-3E475N24-RD4	4,75	2,38	24	0,10 - 0,40	2,4	±0,05	±0,15	☺	☺	☺	☺	☺	☺	☺	☺	☺		☺	☺		
GX24-3E500N25-RD4	5	2,5	24	0,17 - 0,70	0,5 - 2,5	±0,05	±0,15	☺	☺	☺	☺	☺	☺	☺	☺	☺		☺	☺		
GX24-4E600N30-RD4	6	3	24	0,17 - 0,70	0,5 - 3,0	±0,05	±0,15	☺	☺	☺	☺	☺	☺	☺	☺	☺		☺	☺		
GX24-4E635N32-RD4	6,35	3,18	24	0,15 - 0,60	3	±0,05	±0,15	☺	☺	☺	☺	☺	☺	☺	☺	☺		☺	☺		
 GX24-2E300N15-RF8	3	1,5	24	0,10 - 0,30	0,1 - 1,5	±0,02	±0,02	☺	☺	☺	☺	☺	☺	☺	☺	☺		☺	☺		
GX24-3E400N20-RF8	4	2	24	0,12 - 0,45	0,1 - 2,0	±0,02	±0,02	☺	☺	☺	☺	☺	☺	☺	☺	☺		☺	☺		
GX24-3E500N25-RF8	5	2,5	24	0,15 - 0,50	0,1 - 2,5	±0,02	±0,02	☺	☺	☺	☺	☺	☺	☺	☺	☺		☺	☺		
GX24-4E600N30-RF8	6	3	24	0,15 - 0,55	0,1 - 3,0	±0,02	±0,02	☺	☺	☺	☺	☺	☺	☺	☺	☺		☺	☺		
 GX24-4R300N-RK8	6	3	25,4	0,10 - 0,30	4	±0,02	±0,05									☺					
GX24-5R400N-RK8	8	4	25,4	0,10 - 0,35	5	±0,02	±0,05									☺					

l_{Tol} = Repeat accuracy when changing indexable insert
 Radius tolerance r_{Tol} = ±0.05

HC = Coated carbide
 HW = Uncoated carbide

Walter Cut GX grooving inserts Circlip grooves

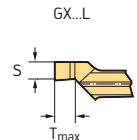
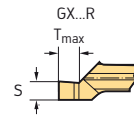
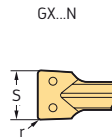
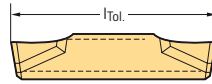

Indexable inserts

Designation	s mm	r mm	T _{max} mm	l mm	f mm	S _{Tol} mm	l _{Tol} mm	P		M		K		S	
								HC		HC		HC		HC	
								WSM23S	WSM33S	WTA33	WSM23S	WSM33S	WTA33	WSM23S	WSM33S
GX09-1S1.00R/L	1		1,14	9	0,05 - 0,10	±0,02	±0,05		☒			☒			
GX09-1S1.20R/L	1,2		1,34	9	0,05 - 0,10	±0,02	±0,05		☒			☒			
GX09-1S1.40R/L	1,4		1,53	9	0,05 - 0,10	±0,02	±0,05		☒			☒			
GX09-1S1.70R/L	1,7		1,82	9	0,05 - 0,10	±0,02	±0,05		☒			☒			
GX09-1S1.95N	2	0,1		9	0,05 - 0,10	±0,02	±0,05		☒			☒			
GX09-1S2.25N	2,3	0,1		9	0,05 - 0,12	±0,02	±0,05		☒			☒			
GX09-2S2.75N	2,8	0,1		9	0,05 - 0,12	±0,02	±0,05		☒			☒			
GX09-2S3.25N	3,3	0,1		9	0,05 - 0,12	±0,02	±0,05		☒			☒			
GX16-2S0.60R/L	0,6		0,75	16	0,05 - 0,10	±0,02	±0,05		☒			☒			
GX16-2S0.80R/L	0,8		0,94	16	0,05 - 0,10	±0,02	±0,05		☒			☒			
GX16-2S0.90R/L	0,9		1,04	16	0,05 - 0,10	±0,02	±0,05		☒			☒			
GX16-2S1.00R/L	1		1,14	16	0,05 - 0,10	±0,02	±0,05		☒			☒			
GX16-2S1.20R/L	1,2		1,34	16	0,05 - 0,10	±0,02	±0,05		☒			☒			
GX16-2S1.40R/L	1,4		1,53	16	0,05 - 0,10	±0,02	±0,05		☒			☒			
GX16-2S1.70R/L	1,7		1,82	16	0,05 - 0,10	±0,02	±0,05		☒			☒			
GX16-2S1.95R/L	2		2,07	16	0,05 - 0,10	±0,02	±0,05		☒			☒			
GX16-2S2.25R/L	2,3		2,36	16	0,05 - 0,12	±0,02	±0,05		☒			☒			
GX16-2S2.75N	2,8	0,1		16	0,05 - 0,12	±0,02	±0,05		☒			☒			
GX16-2S3.25N	3,3	0,1		16	0,07 - 0,14	±0,02	±0,05		☒			☒			
GX16-3S4.25N	4,3	0,2		16	0,07 - 0,20	±0,02	±0,05		☒			☒			
GX16-4S5.25N	5,3	0,2		16	0,08 - 0,20	±0,02	±0,05		☒			☒			

l_{Tol} = Repeat accuracy when changing indexable insert
Radius tolerance r_{Tol} = ±0.05

HC = Coated carbide

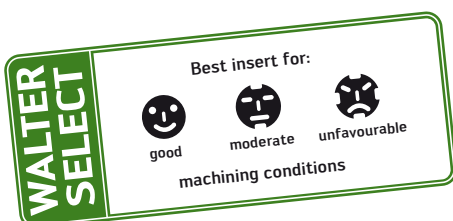

Walter Cut product range overview

Parting off/grooving			
			
GX system		SX system	
XLDE	NCAE / NCBE	G1011-P	G2012
<p>s = 1.5 - 3 mm T_{max} = 16 mm</p>  <p style="text-align: right;">Page 50</p>	<p>s = 2 - 8 mm T_{max} = 21 mm</p>  <p style="text-align: right;">Shank tool: Page A 218* Page A 250*</p> 	<p>s = 2 - 3 mm T_{max} = 21 mm</p>  <p style="text-align: right;">Page 41</p>	<p>s = 2 - 6 mm T_{max} = 40 mm</p>  <p style="text-align: right;">Page 42</p>
XLDE-C	NCLE	G1041R/L	G2042R/L
<p>s = 1.5 - 3 mm T_{max} = 16 mm</p>  <p style="text-align: right;">Page 51</p>	<p>s = 2 - 8 mm T_{max} = 21 mm</p>  <p style="text-align: right;">Shank tool: Page A 220* Page A 254*</p> 	<p>s = 1.5 - 4 mm T_{max} = 32 mm</p>  <p style="text-align: right;">Page 46</p>	<p>s = 2 - 6 mm T_{max} = 32 mm</p>  <p style="text-align: right;">Page 44</p>
G1011	NCCE	G1041R/L-C	G2042R/L-C
<p>s = 2 - 8 mm T_{max} = 32 mm</p>  <p style="text-align: right;">Page 40</p>	<p>s = 0.6 - 2.25 mm T_{max} = 3 mm</p>  <p style="text-align: right;">Shank tool: Page A 220* Page A 256*</p> 	<p>s = 1.5 - 4 mm T_{max} = 32 mm</p>  <p style="text-align: right;">Page 47</p>	<p>s = 1.5 - 4 mm T_{max} = 32 mm</p>  <p style="text-align: right;">Page 45</p>
	NCNE	G1042N	G2042N
	<p>s = 0.6 - 2.25 mm T_{max} = 3 mm</p>  <p style="text-align: right;">Shank tool: Page A 224* Page A 258*</p> 	<p>s = 3 - 6 mm T_{max} = 60 mm</p>  <p style="text-align: right;">Page 48</p>	<p>s = 2 - 6 mm T_{max} = 80 mm</p>  <p style="text-align: right;">Page 43</p>





* The pages indicated in italics refer to the Walter General catalogue 2012.

	Grooving/recessing		Axial grooving		Internal grooving
					
	GX system		GX system		GX system
	G1011	G1511	G1111		I 12
	s = 2 - 8 mm T _{max} = 32 mm	s = 2 - 6 mm T _{max} = 6 mm	s = 3 - 6 mm T _{max} = 25 mm		s = 1.95 - 2.5 mm T _{max} = 3 mm
					
	Page 40	Page 52	Page 54		Page A 245*
	G1521	G1551	NCEE	NCHE	NCAI
	s = 2 - 6 mm T _{max} = 6 mm	s = 3 - 6 mm T _{max} = 6 mm	s = 3 - 6 mm T _{max} = 15 mm	s = 3 - 6 mm T _{max} = 15 mm	s = 1.95 - 6 mm T _{max} = 19 mm
					
	Page 52	Page 53	Shank tool: Page A 232* Page A 264* 	Shank tool: Page A 234* Page A 266* 	Page A 246*
	NCAE / NCBE	NCCE	NCFE	NCOE	NCCI
	s = 2 - 8 mm T _{max} = 21 mm	s = 0.6 - 2.25 mm T _{max} = 3 mm	s = 3 - 6 mm T _{max} = 21 mm	s = 3 - 6 mm T _{max} = 21 mm	s = 0.6 - 3.25 mm T _{max} = 3 mm
					
	Shank tool: Page A 218* Page A 250* 	Shank tool: Page A 222* Page A 256* 	Shank tool: Page A 236* Page A 268* 	Shank tool: Page A 240* Page A 270* 	Page A 248*
	NCLE	NCNE	NCFE-C	NCOE-C	
	s = 2 - 8 mm T _{max} = 21 mm	s = 0.6 - 2.25 mm T _{max} = 3 mm	s = 3 - 6 mm T _{max} = 21 mm	s = 3 - 6 mm T _{max} = 21 mm	
					
	Shank tool: Page A 220* Page A 254* 	Shank tool: Page A 224* Page A 258* 	Shank tool: Page A 240* Page A 272* 	Shank tool: Page A 242* Page A 274* 	

Designation key for Walter Cut grooving tools

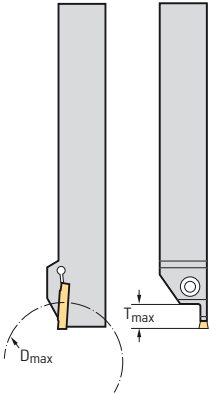
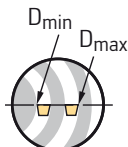
G	1	1	11	-	2020	R	-	3	T33	-	090	GX24	-	P
1	2	3	4		5	6		7	8		9	10		11

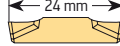
1	2	3	4
Tool group	Generation	Tool type	Tool type
G Grooving	1 GX 2 SX	0 Radial grooving tool 1 Axial grooving tool 5 Grooving tool without supporting blade	11 0° angled straight clamping screw 12 0° angled self-clamping system 21 90° angled straight clamping screw 41 Clamping screw parting blade 42 Parting blade self-clamping system 51 45° angled straight clamping screw

8	9	10
Cutting depth / Parting off diameter	Smallest axial grooving diameter	Insert type
T06 6 mm T12 12 mm T21 21 mm T32 32 mm D16 Dia. 16 mm D32 Dia. 32 mm 	034 Dia. 34 mm 042 Dia. 42 mm 054 Dia. 54 mm 067 Dia. 67 mm 090 Dia. 90 mm 130 Dia. 130 mm 220 Dia. 220 mm 	GX09  GX16  GX24  GX30  SX 

5	
Shank size	
Square shank	
1010	10 x 10 mm
1212	12 x 12 mm
1616	16 x 16 mm
2020	20 x 20 mm
2525	25 x 25 mm
3232	32 x 32 mm

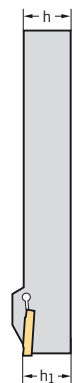

6	
Holder design	
R	Right
L	Left
N	Neutral

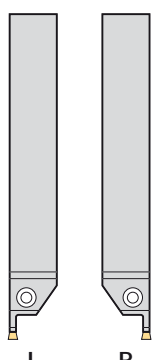

7	
Insert width	
2	2 mm
3	3 mm
4	4 mm
5	5 mm
6	6 mm
8	8 mm

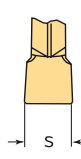

11	
Version	
C	Contra
P	High-pressure cooling

Walter Cut G1011

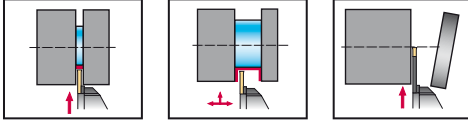
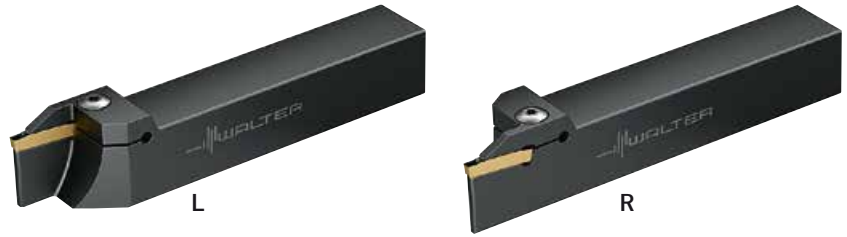

- External machining
- Radial grooving 0°
- One-piece shank tool
- For grooving, recessing and parting off
- For GX cutting inserts

Tool

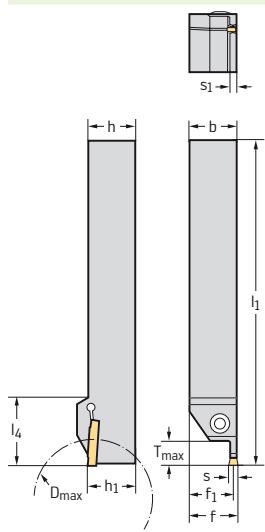

Designation	s mm	T _{max} mm	D _{max} mm	h=h ₁ mm	b mm	f ₁ mm	l ₁ mm	l ₄ mm	s ₁ mm	Type		
G1011.1212R/L-2T8GX16	2	8	12	12	12	11	122	32	1,6	GX 16-1E2/F2...		
G1011.1212R/L-2T12GX16		12	12	12	12	11	122	32	1,6			
G1011.1616R/L-2T8GX16		8	16	16	16	15	132	36	1,6			
G1011.1616R/L-2T15GX16		16	16	16	16	15	136	36	1,6			
G1011.2020R/L-2T8GX16		8	20	20	19	142	32	1,6				
G1011.2020R/L-2T15GX16		16	20	20	19	146	36	1,6				
G1011.2525R/L-2T8GX16		8	25	25	24	142	32	1,6				
G1011.2525R/L-2T15GX16		16	25	25	24	146	36	1,6				
G1011.1616R/L-2T21GX24		2	21	16	16	15	150	40	1,6		GX 24-1E2...	
G1011.2020R/L-2T21GX24			21	20	20	19	150	40	1,6			
G1011.1616R/L-3T12GX24			12	16	16	15	135	35	2,4			
G1011.1616R/L-3T21GX24		3	21	80	16	16	15	150	40		2,4	GX 24-2E3/F3...
G1011.2020R/L-3T12GX24			12	20	20	19	145	35	2,4			
G1011.2012R/L-3T21GX24			21	80	20	12	11	150	40		2,4	
G1011.2020R/L-3T21GX24			21	80	20	20	19	150	40		2,4	
G1011.2525R/L-3T12GX24			12	25	25	24	145	35	2,4			
G1011.2525R/L-3T21GX24	21		80	25	25	24	150	40	2,4			
G1011.1616R/L-4T12GX24	4		12	16	16	14	135	35	3,4	GX 24-3E4/F4...		
G1011.1616R/L-4T21GX24			21	80	16	16	14	150	40		3,4	
G1011.2020R/L-4T12GX24		12	20	20	18	145	35	3,4				
G1011.2012R/L-4T21GX24		21	80	20	12	10	150	40	3,4			
G1011.2020R/L-4T21GX24		21	80	20	20	18	150	40	3,4			
G1011.2525R/L-4T12GX24		12	25	25	23	145	35	3,4				
G1011.2525R/L-4T21GX24		21	80	25	25	23	150	40	3,4			
G1011.2525R/L-4T32GX24		32	25	25	23	165	55	3,4				
G1011.2020R/L-5T12GX24		5	12	20	20	18	145	35	4,2		GX 24-3E5/F5...	
G1011.2020R/L-5T21GX24			21	80	20	20	18	150	40			4,2
G1011.2525R/L-5T12GX24			12	25	25	23	145	35	4,2			
G1011.2525R/L-5T21GX24			21	80	25	25	23	150	40			4,2
G1011.2525R/L-5T32GX24	32	120	25	25	23	165	55	4,2				
G1011.2020R/L-6T12GX24	6	12	20	20	17	145	35	5,2	GX 24-4E6/F6...			
G1011.2020R/L-6T21GX24		21	80	20	20	17	150	40		5,2		
G1011.2525R/L-6T12GX24		12	25	25	22	145	35	5,2				
G1011.2525R/L-6T21GX24		21	80	25	25	22	150	40		5,2		
G1011.2525R/L-6T32GX24		32	120	25	25	22	165	55		5,2		
G1011.2525R/L-8T28GX30		8	28	120	25	25	22	165		55	6,1	GX 30-5E8..
G1011.3232R/L-8T28GX30	28		120	32	32	29	165	55	6,1			

For T_{max} with greater diameters than D_{max}, see technical information on page 73.

$$f = f_1 + s/2$$

Ordering example: Right-handed shank tool: G1011.2020R-3T12GX24 / left-handed shank tool: G1011.2020L-3T12GX24

Bodies and assembly parts are included in the scope of delivery.

Assembly parts

	Type	GX 16-1E2/F2...-GX 30-5E8..
	Clamping screw for grooving insert Tightening torque	FS2118 (Torx 20IP) 5,0 Nm
	Torx key	FS1464 (Torx 20IP)



Walter Cut G1011-P

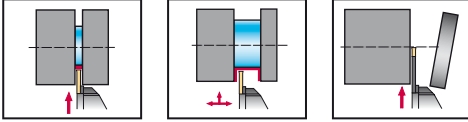
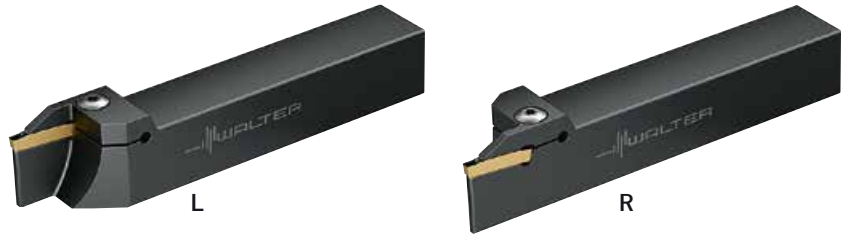

- External machining
- Radial grooving 0°
- One-piece shank tool with internal coolant supply
- For grooving, recessing and parting off
- For GX cutting inserts

Tool	Designation	s mm	T _{max} mm	D _{max} mm	h=h ₁ mm	b mm	f ₁ mm	l ₁ mm	l ₄ mm	s ₁ mm	Type
	G1011.1616R/L-2T15GX16-P*	2	16	32	16	16	15	125	36	1,5	GX 16-1E2/F2 ..
	G1011.1616R/L-2T21GX24-P*	2	21	80	16	16	15	125	40	1,6	GX 24-1E2 ..
	G1011.1616R/L-3T21GX24-P*	3	21	80	16	16	15	125	40	2,4	GX 24-2E3/F3 ..
	G1011.2020R/L-2T15GX16-P*	2	16	32	20	20	19	125	36	1,6	GX 16-1E2/F2 ..
	G1011.2020R/L-2T21GX24-P*	2	21	80	20	20	19	125	40	1,6	GX 24-1E2 ..
	G1011.2020R/L-3T21GX24-P*	3	21	80	20	20	19	125	40	2,4	GX 24-2E3/F3 ..
	G1011.2525R/L-3T21GX24-P*	3	21	80	25	25	24	125	40	2,4	GX 24-2E3/F3 ..

For T_{max} with greater diameters than D_{max}, see technical information on page 73.

f = f₁ + s/2

Ordering example: Right-handed shank tool: G1011.2020R-3T21GX24-P / left-handed shank tool: G1011.2020L-3T21GX24-P

Bodies and assembly parts are included in the scope of delivery.

* available from Q4/2014

Assembly parts

	Type	GX 16-1E2/F2 ..-GX 30-5E8..
	Clamping screw for grooving insert Tightening torque	FS2118 (Torx 20IP) 5,0 Nm
	Torx key	FS1464 (Torx 20IP)



Walter Cut G2012

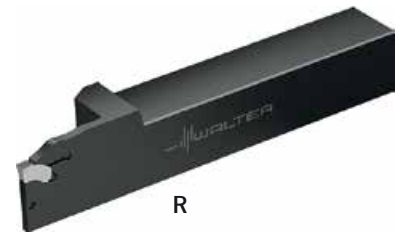

R

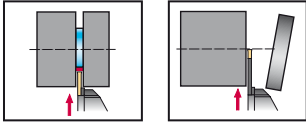

- External machining
- Radial grooving 0°
- One-piece shank tool with internal coolant supply
- For grooving and parting off
- For SX cutting inserts

Tool

Designation	s mm	T _{max} mm	h = h ₁ mm	b mm	f ₁ mm	l ₁ mm	l ₄ mm	Type
G2012.1212R/L-1.5T15SX	1,5	15	12	12	11,4	120	25	SX-1..
G2012.1616R/L-1.5T15SX		15	16	16	15,4	120	25	SX-1..
G2012.1212R/L-2T16SX-P	2	16	12	12	11	120	25	SX-2..
G2012.1616R/L-2T16SX-P		16	16	16	15	120	25	SX-2..
G2012.1212R/L-3T16SX-P	3	16	12	12	11	120	25	SX-3..
G2012.1616R/L-3T16SX-P		16	16	16	15	120	25	SX-3..
G2012.2020R/L-1.5T15SX	1,5	15	20	20	19,4	120	25	SX-1..
G2012.2020R/L-2T20SX-P	2	20	20	20	19	125	37	SX-2..
G2012.2020R/L-3T22SX-P	3	22	20	20	20	125	38	SX-3..
G2012.2525R/L-3T33SX-P		33	25	25	25	125	43	SX-3..
G2012.2020R/L-4T29SX-P	4	29	20	20	20	125	45	SX-4..
G2012.2525R/L-4T33SX-P		33	25	25	25	125	48	SX-4..
G2012.2020R/L-5T29SX-P	5	29	20	20	18	125	44	SX-5..
G2012.2525R/L-5T40SX-P		40	25	25	18	125	44	SX-5..
G2012.2525R/L-6T40SX-P	6	40	25	25	22	125	51	SX-6..

For instructions on replacing the cutting edge, see page 62. For the connection set for internal coolant supply with G1/8" thread, see page 63.
 $f = f_1 + s/2$

Ordering example: Right-handed shank tool: G2012.2020R-3T22SX-P / left-handed shank tool: G2012.2020L-3T22SX-P

Assembly parts

	1/8" blanking plugs	FS2258
---	---------------------	--------

Accessories

Type h = mm	SX-1.. 12-20	SX-2..-SX-3.. 12-16	SX-2..-SX-6.. 20-25
 Mounting wrench for grooving insert	FS2249	FS2249	FS1494



Walter Cut G2042 N

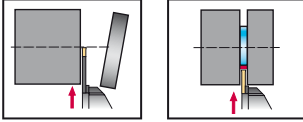
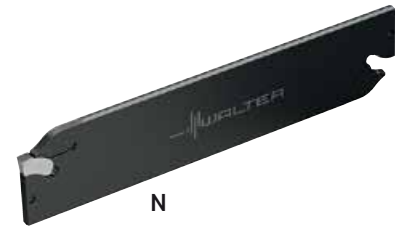

- External machining
- Radial grooving 0°
- Deep parting blade
- For parting off and grooving
- For SX cutting inserts

Tool	Designation	s mm	T _{max} mm	h ₄ mm	l ₁ mm	h ₁ mm	Type	
	G2042.26N-2T30SX	2	30	26	150	21,1	SX-2...	
	G2042.32N-2T30SX		30	32	150	24,8	SX-2...	
	G2042.26N-3T38SX	3	38	26	150	21	SX-3...	
	G2042.32N-3T50SX		50	32	150	24,7	SX-3...	
	G2042.26N-4T40SX	4	40	26	150	20,9	SX-4...	
	G2042.32N-4T50SX		50	32	150	24,54	SX-4...	
	G2042.32N-5T60SX	5	60	32	150	24,4	SX-5...	
	G2042.46N-5T80SX		80	46	150	37,4	SX-5...	
	G2042.32N-6T60SX	6	60	32	150	24,3	SX-6...	
	G2042.46N-6T80SX		80	46	150	36,9	SX-6...	

For clamping blocks, see page 49.

For instructions on replacing the cutting edge, see page 62.

Accessories	Type	SX-2...-SX-6...
	Mounting wrench for grooving insert	FS1494



Walter Cut G2042 R/L

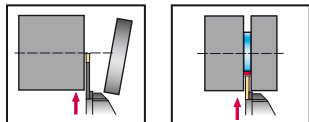

- External machining
- Radial grooving 0°
- Deep parting blade
- For parting off and grooving
- For SX cutting inserts

Tool

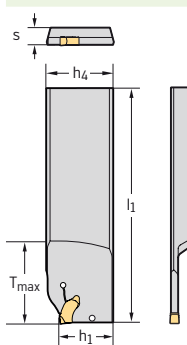

Designation	s mm	T _{max} mm	h ₄ mm	l ₁ mm	h ₁ mm	Type
G2042.26L/R-1,5T20SX*	1,5	20	26	110	21	SX-1E15 ..
G2042.32L/R-1,5T20SX*		20	32	110	24,6	
G2042.26L/R-2T26SX	2	26	26	110	21	SX-2E2 ..
G2042.32L/R-2T26SX		26	32	110	24,65	
G2042.26L/R-3T33SX	3	33	26	110	21	SX-3E3 ..
G2042.32L/R-3T33SX		33	32	110	24,65	
G2042.32L/R-4T33SX	4	33	32	110	24,65	SX-4E4 ..

For clamping blocks, see page 49.

For instructions on replacing the cutting edge, see page 62.

* available from Q4/2014

Accessories

Type	SX-1 ..	SX-2 .. – SX-4 ..
Mounting wrench for grooving insert	FS2249	FS1494

**Walter Cut
G2042 R/L-C
Contra version**

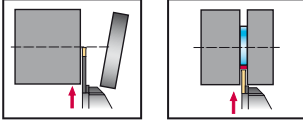

- External machining
- Radial grooving 0°
- Deep parting blade
- For parting off and grooving
- For SX cutting inserts

Tool

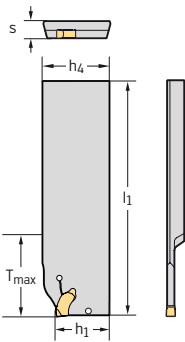

Designation	s mm	T _{max} mm	h ₄ mm	l ₁ mm	h ₁ mm	Type
G2042.26L/R-1,5T20SX-C*	1,5	20	26	110	21	SX-1E15 ..
G2042.32L/R-1,5T20SX-C*			32		24,6	
G2042.26L/R-2T26SX-C	2	26	26	110	21	SX-2E2 ..
G2042.32L/R-2T26SX-C			32		24,6	
G2042.26L/R-3T33SX-C	3	33	26	110	21	SX-3E3 ..
G2042.32L/R-3T33SX-C			32		24,6	
G2042.32L/R-4T33SX-C	4	33	32	110	24,6	SX-4E4 ..

For clamping blocks, see page 49.

For instructions on replacing the cutting edge, see page 62.

* available from Q4/2014

Accessories

Type	SX-1 ..	SX-2 .. – SX-4 ..
 Mounting wrench for grooving insert	FS2249	FS1494



Walter Cut G1041 R/L

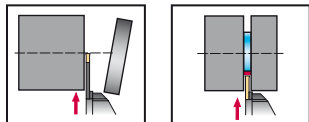

- External machining
- Radial grooving 0°
- Deep parting blade
- For parting off and grooving
- For GX cutting inserts

Tool

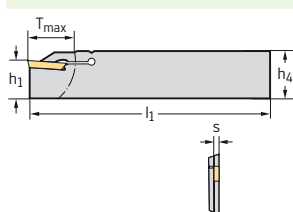

Designation	s mm	T _{max} mm	h ₄ mm	l ₁ mm	h ₁ mm	Type
G1041.26R/L-1.5T16GX16	1,5	16	26	110	21	GX16-0E..
G1041.26R/L-2T16GX16	2	16	26	110	21	GX16-1E2/F2..
G1041.32R/L-2T23GX16		23	32	110	24,6	
G1041.26R/L-2T23GX24*	2	23	26	110	21	GX24-1E2..
G1041.26R/L-2T32GX24*		32	26	110	21	
G1041.32R/L-2T23GX24*		23	32	110	24,6	
G1041.32R/L-2T32GX24*		32	32	110	24,6	
G1041.26R/L-3T16GX16	3	16	26	110	21	GX16-2E3/F3..
G1041.26R/L-3T23GX24		23	26	110	21	GX24-2E3/F3..
G1041.32R/L-3T23GX24		23	32	110	24,6	
G1041.32R/L-3T32GX24		32	32	110	24,6	
G1041.32R/L-4T32GX24	4	32	32	110	24,6	GX24-3E4/F4..

For clamping blocks, see page 49.

For description of contra version/standard version, see page 62.

Bodies and assembly parts are included in the scope of delivery.

* available from Q4/2014

Assembly parts

Type	GX16-0E . . . –GX24-3E . . .
 Clamping screw for grooving insert Tightening torque	FS2164 (Torx 15IP) 3,5 Nm

Accessories

Type	GX16-0E . . . –GX24-3E . . .
 Screwdriver	FS1485 (Torx 15IP)



**Walter Cut
G1041 R/L-C
Contra version**

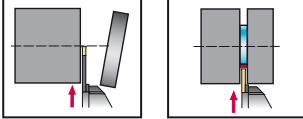

- External machining
- Radial grooving 0°
- Deep parting blade
- For parting off and grooving
- For GX cutting inserts

Tool	Designation	s mm	T _{max} mm	h ₄ mm	l ₁ mm	h ₁ mm	Type	
	G1041.26R/L-1.5T16GX16C	1,5	16	26	110	21	GX16-0E ..	
	G1041.26R/L-2T16GX16C	2	16	26	110	21	GX16-1E2/F2 ..	
	G1041.32R/L-2T23GX16C		23	32	110	24,6		
	G1041.26R/L-2T23GX24C*	2	23	26	110	21	GX24-1E2..	
	G1041.26R/L-2T32GX24C*		32	26	110	21		
	G1041.32R/L-2T23GX24C*		23	32	110	24,6		
	G1041.32R/L-2T32GX24C*		32	32	110	24,6		
	G1041.26R/L-3T16GX16C	3	16	16	26	110	21	GX16-2E3/F3 ..
	G1041.26R/L-3T23GX24C		23	26	110	21	GX24-2E3/F3 ..	
	G1041.32R/L-3T23GX24C		23	32	110	24,6		
	G1041.32R/L-3T32GX24C		32	32	110	24,6		
	G1041.32R/L-4T32GX24C	4	32	32	110	24,6		GX24-3E4/F4 ..

For clamping blocks, see page 49.

For description of contra version/standard version, see page 62.

Bodies and assembly parts are included in the scope of delivery.

* available from Q4/2014

Assembly parts

	Type	GX16-0E .. –GX24-3E ..
	Clamping screw for grooving insert Tightening torque	FS2164 (Torx 15IP) 3,5 Nm

Accessories

	Type	GX16-0E .. –GX24-3E ..
	Screwdriver	FS1485 (Torx 15IP)



Walter Cut G1042

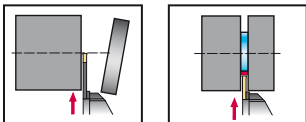

- External machining
- Radial grooving 0°
- Deep parting blade
- For parting off and grooving
- For GX cutting inserts

Tool	Designation	s mm	T _{max} mm	h ₄ mm	l ₁ mm	h ₁ mm	Type
	G1042.26N-2T25GX16	2	25	26	108,3	21,1	GX16-1E2/F2...
	G1042.32N-2T25GX16		25	32	149,3	24,8	GX24-1E2...
	G1042.26N-2T40GX24		40	26	149,3	21,0	
	G1042.32N-2T50GX24		50	32	149,3	24,5	
	G1042.26N-3T40GX24	3	40	26	108,3	21	GX24-2E3/F3...
	G1042.32N-3T50GX24						
	G1042.26N-4T40GX24	4	40	26	108,3	20,9	GX24-3E4/F4...
	G1042.32N-4T50GX24						
	G1042.32N-5T60GX24	5	60	32	149,3	24,5	GX24-3E5/F5...
	G1042.32N-6T60GX24	6	60	32	149,3	24,4	GX24-4E6/F6...

For clamping blocks, see page A 217.

For instructions on replacing the cutting edge, see page A 314.

Accessories

	Type	GX16-1E2/F2 . . .-GX24-4E6/F6...
	Mounting wrench for grooving insert	FS1494



Walter Cut SBN



- Clamping blocks for parting blades

Tool	Designation	h_4 mm	h_1 mm	b mm	l_1 mm
	SBN2020-26-K	26	20	20	90
	SBN2520-32-K	32	25	20	110
	SBN3229-32-K	32	32	29	120
	SBN3229-46-K	46	32	29	150
	SBN4037-46-K	46	40	47	150

Bodies and assembly parts are included in the scope of delivery.

Assembly parts	h_1 mm	20-32	40
	Clamping screw	M06X025 ISO4762 12.9	M08X035 ISO4762 12.9

Walter Cut XLDE

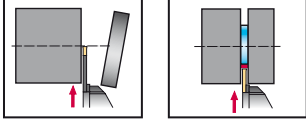
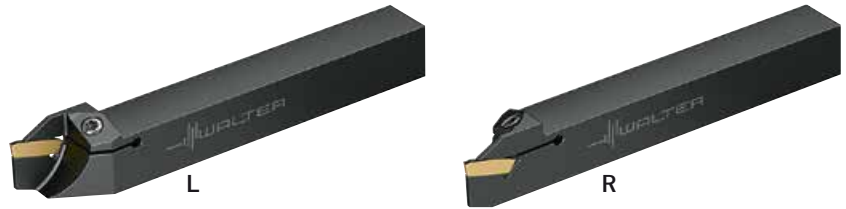

- External machining
- Radial grooving 0°
- One-piece shank tool
- For grooving and parting off
- For GX inserts

Tool

Designation	s mm	D _{max} mm	h=h ₁ mm	b mm	f ₁ mm	l ₁ mm	l ₄ mm	s ₁ mm	Type
XLDER/L1010K-GX16-0	1,5	10	10	10	9,4	125	19	1,2	GX16-0E150..
XLDER/L1212K-GX16-0		12	12	12	11,4	125	19	1,2	
XLDER/L1616K-GX16-0		16	16	16	15,4	125	24	1,2	
XLDER/L1010K-GX16-1	2,0 - 2,5	20	10	10	9,2	125	19	1,6	GX16-1E2..
XLDER/L1212K-GX16-1		24	12	12	11,2	125	19	1,6	
XLDER/L1616K-GX16-1		32	16	16	15,2	125	24	1,6	
XLDER/L2020K-GX16-1	3	32	20	20	19,2	125	24	1,6	GX16-2E3..
XLDER/L1212K-GX16-2		24	12	12	10,8	125	19	2,4	
XLDER/L1616K-GX16-2		32	16	16	14,8	125	24	2,4	
XLDER/L2020K-GX16-2		32	20	20	18,8	125	24	2,4	

$f = f_1 + s/2$

Ordering example:

Right-handed shank tool: XLDER1010K-GX16-1

Left-handed shank tool: XLDEL1010K-GX16-1

Bodies and assembly parts are included in the scope of delivery.

Assembly parts

	Type	GX16-0E150..-GX16-2E3..
	Clamping screw for grooving insert Tightening torque	FS2164 (Torx 15IP) 3,5 Nm
	Screwdriver	FS1485 (Torx 15IP)

Tool designs:



XLDE R



XLDE L



Walter Cut XLDE-C Contra version

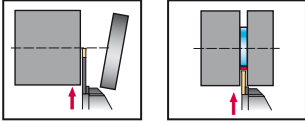
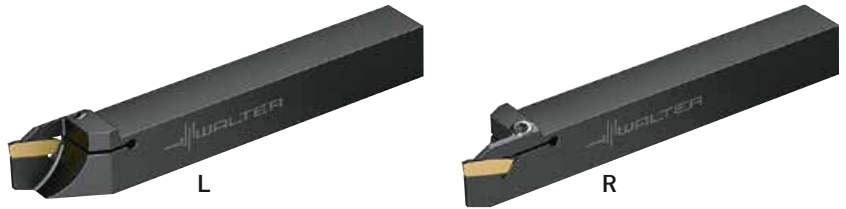

- External machining
- Radial grooving 0°
- One-piece shank tool
- For grooving and parting off
- For GX inserts

Tool	Designation	s mm	D _{max} mm	h=h ₁ mm	b mm	f ₁ mm	l ₁ mm	l ₄ mm	s ₁ mm	Type
	XLDER/L1010K-GX16-0C	1,5	10	10	10	9,2	125	19	1,2	GX16-0E150..
	XLDER/L1212K-GX16-0C		12	12	12	11,2	125	19	1,2	
	XLDER/L1616K-GX16-0C		12	16	16	15,2	125	24	1,2	
	XLDER/L1010K-GX16-1C	2,0 - 2,5	20	10	10	9,2	125	19	1,6	GX16-1E2..
	XLDER/L1212K-GX16-1C		24	12	12	11,2	125	19	1,6	
	XLDER/L1616K-GX16-1C		32	16	16	15,2	125	24	1,6	
	XLDER/L1212K-GX16-2C	3	24	12	12	10,8	125	19	2,4	GX16-2E3..
	XLDER/L1616K-GX16-2C		32	16	16	14,8	125	24	2,4	

f = f₁+s/2
 Ordering example:
 Right-handed shank tool: XLDER1010K-GX16-1C
 Left-handed shank tool: XLDEL1010K-GX16-1C
 Bodies and assembly parts are included in the scope of delivery.

Assembly parts	Type	GX16-0E150..-GX16-2E3..
	Clamping screw for grooving insert Tightening torque	FS2164 (Torx 15IP) 3,5 Nm
	Screwdriver	FS1485 (Torx 15IP)

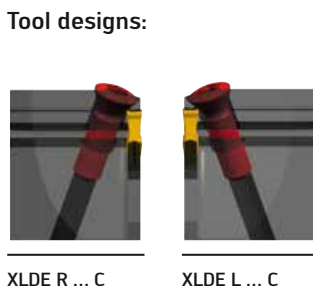

Walter Cut G1111

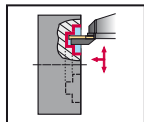

- External machining
- One-piece shank tool
- For axial grooving
- For GX inserts

Tool

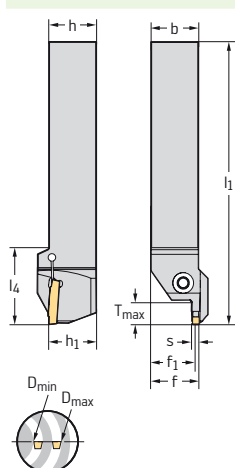

Designation	s mm	T _{max} mm	D _{min} mm	D _{max} mm	h=h ₁ mm	b mm	f mm	l ₁ mm	l ₄ mm	Type
G1111.2525R/L-3T12-034GX24	3	12	34	44	25	25	26,2	150	40	GX24-2E3 . .
G1111.2525R/L-3T12-042GX24		12	42	60	25	25	26,2	150	40	
G1111.2525R/L-3T12-054GX24		12	54	75	25	25	26,1	150	40	
G1111.2525R/L-3T19-054GX24		19	54	75	25	25	26,2	152	42	
G1111.2525R/L-3T22-067GX24		22	67	100	25	25	26,2	154	44	
G1111.2525R/L-3T12-067GX24		12	67	100	25	25	26,1	150	40	
G1111.2525R/L-3T12-090GX24		12	90	160	25	25	26,1	150	40	
G1111.2525R/L-3T22-090GX24		22	90	160	25	25	26,1	154	44	
G1111.2525R/L-3T12-130GX24		12	130	300	25	25	26,1	150	40	
G1111.2525R/L-3T22-130GX24		22	130	300	25	25	26,1	154	44	
G1111.2525R/L-4T12-040GX24	4	12	40	60	25	25	26,1	150	40	GX24-3E4/F4 . .
G1111.2525R/L-4T20-040GX24		20	40	60	25	25	26,3	152	42	
G1111.2525R/L-4T12-052GX24		12	52	72	25	25	26,1	150	40	
G1111.2525R/L-4T20-052GX24		20	52	72	25	25	26,2	152	42	
G1111.2525R/L-4T12-064GX24		12	64	100	25	25	26,1	150	40	
G1111.2525R/L-4T25-064GX24		25	64	100	25	25	26,1	156	46	
G1111.2525R/L-4T12-092GX24		12	92	140	25	25	26,1	150	40	
G1111.2525R/L-4T25-092GX24		25	92	140	25	25	26,1	156	46	
G1111.2525R/L-4T25-132GX24		25	132	230	25	25	26,1	156	46	
G1111.2525R/L-4T12-132GX24		12	132	230	25	25	26,1	150	40	
G1111.2525R/L-4T12-220GX24	5	12	220	500	25	25	26,1	150	40	GX24-3E5/F5 . .
G1111.2525R/L-4T25-220GX24		25	220	500	25	25	26,1	156	46	
G1111.2525R/L-5T20-040GX24		20	40	70	25	25	26,3	152	42	
G1111.2525R/L-5T12-040GX24		12	40	70	25	25	26,2	150	40	
G1111.2525R/L-5T20-060GX24		20	60	95	25	25	26,3	152	42	
G1111.2525R/L-5T12-060GX24		12	60	95	25	25	26,2	150	40	
G1111.2525R/L-5T12-085GX24		12	85	130	25	25	26,2	150	40	
G1111.2525R/L-5T25-085GX24		25	85	130	25	25	26,2	156	46	
G1111.2525R/L-5T25-120GX24		25	120	180	25	25	26,2	156	46	
G1111.2525R/L-5T12-120GX24		12	120	180	25	25	26,2	150	40	
G1111.2525R/L-5T12-175GX24	5	12	175	500	25	25	26,1	150	40	GX24-3E5/F5 . .
G1111.2525R/L-5T25-175GX24		25	175	500	25	25	26,2	156	46	

Max. double-sided insert cutting depth 23 mm

Ordering example:

Right-handed shank tool: G1111.2525R-5T12-085GX24

Left-handed shank tool: G1111.2525L-5T12-085GX24

Walter Cut G1111

Continued

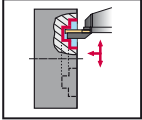
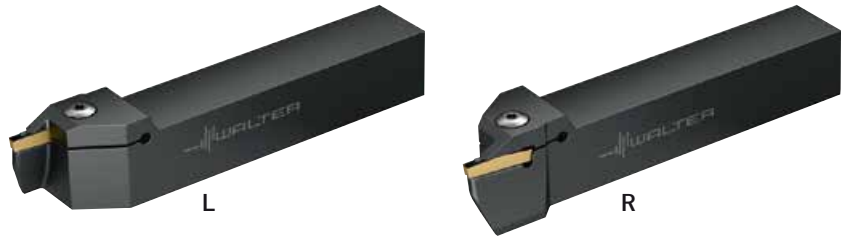

- External machining
- One-piece shank tool
- For axial grooving
- For GX inserts

Tool	Designation	s mm	T _{max} mm	D _{min} mm	D _{max} mm	h=h ₁ mm	b mm	f mm	l ₁ mm	l ₄ mm	Type
	G1111.2525R/L-6T12-040GX24	6	12	40	70	25	25	26,2	150	40	GX24-4E6/F6 . .
	G1111.2525R/L-6T20-040GX24		25	40	70	25	25	26,3	152	42	
	G1111.2525R/L-6T12-058GX24		12	58	100	25	25	26,2	150	40	
	G1111.2525R/L-6T25-058GX24		25	58	100	25	25	26,2	156	46	
	G1111.2525R/L-6T12-088GX24		12	88	180	25	25	26,2	150	40	
	G1111.2525R/L-6T25-088GX24		25	88	180	25	25	26,2	156	46	
	G1111.2525R/L-6T12-168GX24		12	168	400	25	25	26,2	150	40	
	G1111.2525R/L-6T25-168GX24		25	168	400	25	25	26,2	156	46	

Max. double-sided insert cutting depth 23 mm

Ordering example:

$$f = f_1 + s/2$$

Right-handed shank tool: G1111.2525R-5T12-085GX24

Left-handed shank tool: G1111.2525L-5T12-085GX24

Assembly parts

	Type	GX24-2E3 . . -GX24-4E6/F6 . .
	Clamping screw for grooving insert Tightening torque	FS2118 (Torx 20IP) 4,0 Nm
	Torx key	FS1464 (Torx 20IP)



Cutting data for Walter Cut

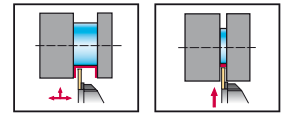

Material group	Structure of main material groups and code letters		Brinell hardness HB	Tensile strength R _m N/mm ²	Machining group ¹		Cutting material grades			
							Starting values for cutting speed v _c [m/min]			
							HC			
							WSM13S	WSM23S		
P	Non-alloyed steel	C ≤ 0.25%	Annealed	125	428	P1	●●●	200	190	
		C > 0.25... ≤ 0.55%	Annealed	190	639	P2	●●●	180	170	
		C > 0.25... ≤ 0.55%	Tempered	210	708	P3	●●●	170	160	
		C > 0.55%	Annealed	190	639	P4	●●●	190	180	
		C > 0.55%	Tempered	300	1013	P5	●●●	160	150	
		Free cutting steel (short-chipping)	Annealed	220	745	P6	●●●	190	180	
	Low-alloyed steel		Annealed	175	591	P7	●●●	190	180	
			Tempered	300	1013	P8	●●●	160	150	
			Tempered	380	1282	P9	●●●	160	150	
			Tempered	430	1477	P10	●●●			
High-alloyed steel and high-alloyed tool steel		Annealed	200	675	P11	●●●	140	130		
		Hardened and tempered	300	1013	P12	●●●	120	110		
		Hardened and tempered	400	1361	P13	●●●				
Stainless steel		Ferritic/martensitic, annealed	200	675	P14	●●●	190	180		
		Martensitic, tempered	330	1114	P15	●●●	120	100		
M	Stainless steel	Austenitic, quench hardened		200	675	M1	●●●	190	170	
		Austenitic, precipitation hardened (PH)		300	1013	M2	●●●	120	100	
		Austenitic/ferritic, duplex		230	778	M3	●●●	170	150	
K	Malleable cast iron	Ferritic		200	675	K1	●●●	190	180	
		Pearlitic		260	867	K2	●●●	170	160	
	Grey cast iron	Low tensile strength		180	602	K3	●●●	220	210	
		High tensile strength/austenitic		245	825	K4	●●●	180	170	
	Cast iron with spheroidal graphite	Ferritic		155	518	K5	●●●	220	210	
		Pearlitic		265	885	K6	●●●	180	170	
	GGV (CGI)		200	675	K7	●●●				
N	Aluminium wrought alloys	Cannot be hardened		30	-	N1	●●●			
		Hardenable, hardened		100	343	N2	●●●			
	Cast aluminium alloys	≤ 12% Si, cannot be hardened		75	260	N3	●●●			
		≤ 12% Si, hardenable, hardened		90	314	N4	●●●			
		> 12% Si, cannot be hardened		130	447	N5				
	Magnesium alloys		70	250	N6					
	Copper and copper alloys (bronze/brass)	Non-alloyed, electrolytic copper		100	343	N7	●●●			
Brass, bronze, red brass			90	314	N8	●●●				
Cu-alloys, short-chipping			110	382	N9	●●●				
High-strength, Ampco			300	1013	N10					
S	Heat-resistant alloys	Fe-based	Annealed	200	675	S1	●●●	110	100	
			Hardened	280	943	S2	●●●	60	50	
		Ni or Co base	Annealed	250	839	S3	●●●	90	80	
			Hardened	350	1177	S4	●●●	80	70	
			Cast	320	1076	S5	●●●	80	70	
	Titanium alloys	Pure titanium		200	675	S6	●●●	160	150	
		α and β alloys, hardened		375	1262	S7	●●●	45	40	
		β alloys		410	1396	S8	●●●	35	30	
Tungsten alloys		300	1013	S9						
Molybdenum alloys		300	1013	S10						
H	Hardened steel	Hardened and tempered	50 HRC	-	H1					
		Hardened and tempered	55 HRC	-	H2					
		Hardened and tempered	60 HRC	-	H3					
	Hardened cast iron	Hardened and tempered	55 HRC	-	H4					
O	Thermoplastics	Without abrasive fillers			O1					
	Thermosetting plastics	Without abrasive fillers			O2					
	Plastic, glass-fibre reinforced	GFRP			O3					
	Plastic, carbon-fibre reinforced	CFRP			O4					
	Plastic, aramid-fibre reinforced	AFRP			O5					
	Graphite (technical)		80 Shore			O6				

- Recommended application (the specified cutting data are regarded as starting values for the recommended application)
- Possible application

¹ The classification of the machining groups can be found in the Walter General Catalogue 2012 from page H 8 onwards.

1. Grooving and recessing

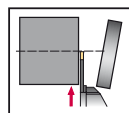

2. Parting off

							Cutting material grades						
							Starting values for cutting speed v_c [m/min]						
	WSM33S	WSM43S	WTA33	WKP13S	WKP23S	WKP33S	HC					HW	
	WSM13S	WSM23S	WSM33S	WSM43S	WKP23S	WKP33S	WSM13S	WSM23S	WSM33S	WSM43S	WKP23S	WKP33S	WK1
	↑	↑	↑	↑	↑	↑	↑	↑	↑	↑	↑	↑	↑
	180	170	190	220	200	180	190	180	170	160	150	190	
	170	160	180	200	180	170	180	170	160	150	140	170	
	150	140	160	190	170	160	160	150	140	130	120	160	
	170	160	180	200	180	170	180	170	160	150	140	170	
	140	130	120	170	150	150	150	140	130	120	110	140	
	170	160	180	200	180	170	180	170	160	150	140	170	
	160	150	180	200	180	160	180	170	150	140	130	170	
	110	100	150	170	150	150	150	140	100	90	80	140	
	100	100	130	170	150	130	150	140	90	80	70	140	
				100	80	60							
	120	110	180	180	170	160	130	120	110	100	90	120	
	90	80	140	160	150	140	110	100	80	70	60	100	
				100	80	60							
	160	140	180	200	180	160	180	170	150	140	130		
	80	60	100	130	120	110	100	90	70	60	50		
	150	130	150				170	160	140	120	110		
	80	60	100	130	120	110	100	90	70	60	50		
	130	110	130				150	140	120	110	100		
	170		100	190	160	140	180	170	160	150	140	180	
	150		60	170	130	100	160	150	140	130	120	160	
	200		260	350	330	250	230	220	210	200	190	230	
	160		210	310	300	290	190	180	170	160	150	190	
	200		240	300	290	280	210	200	190	180	170	210	
	160		190	260	250	240	170	160	150	140	130	170	
				220	200	180						190	
													900
													600
													350
													250
													400
													300
													200
	90	80					100	90	80	70			
	40	30					50	40	30	25			
	70	60					80	70	60	50			
	60	50					70	60	50	40			
	60	50					70	60	50	40			
	130	120					150	140	130	110			
	35	30					50	40	30	25			
	25						40	30	25				

HC = Coated carbide
 HW = Uncoated carbide

The specified cutting data are average recommended values.
 For special applications, adjustment is recommended.

Cutting tool material application tables









Walter grade designation	Standard designation	Workpiece material group							Range of applications							Coating process	Coating composition	Indexable insert example
		P Steel	M Stainless steel	K Cast iron	N NF metals	S Materials with difficult machining properties	H Hard materials	O Other	01	10	20	30	40	05	15			
WSM13S	HC - M 10		●●													PVD	TiAlN + Al ₂ O ₃ (Al)	
	HC - S 10					●●												
	HC - P 10	●																
WSM23S	HC - M 20		●●													PVD	TiAlN + Al ₂ O ₃ (Al)	
	HC - S 20					●●												
	HC - P 20	●●																
WSM33S	HC - S 30					●●										PVD	TiAlN + Al ₂ O ₃ (Al)	
	HC - M 30		●●															
	HC - P 35	●●																
WSM43S	HC - S 45					●●										PVD	TiAlN + Al ₂ O ₃ (Al)	
	HC - M 45		●●															
	HC - P 45	●●																
WTA 33	HC - P 10	●●													CVD	TiCN + Al ₂ O ₃		
	HC - K 10			●														
WKP13S	HC - P 10	●●													CVD	TiCN + Al ₂ O ₃ (+TiCN)		
	HC - K 20			●●														
	HC - H 10						●											
WKP23S	HC - P 20	●●													CVD	TiCN + Al ₂ O ₃ (+TiCN)		
	HC - K 30			●●														
WKP33S	HC - P 30	●●													CVD	TiCN + Al ₂ O ₃ (+TiCN)		
	HC - K 30			●●														

HC = Coated carbide
HW = Uncoated carbide



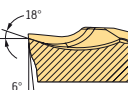

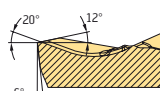

●● Primary application
● Other application

Geometry overview of cutting inserts

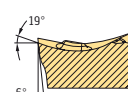
SX system for grooving and parting off

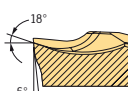
Geometry	Remarks/ field of applications	Workpiece material group							Section of main cutting edge	View Main cutting edge	s [mm]	f [mm]
		P Steel	M Stainless steel	K Cast iron	N NF metals	S Materials with difficult cutting properties	H Hard materials	O Other				
 <p>CF6 – Low feed rate – Low burr/centre pip formation – Low cutting force</p>		●●	●●		●●	●●		●			1,5	0,03 – 0,10
											2	0,03 – 0,12
											3	0,04 – 0,20
 <p>CF5 – Grooving and parting off operations – Light to moderate feed rates – Good chip control – Low burr/centre pip formation</p>		●●	●●	●	●●	●●		●			1,5	0,03 – 0,13
											2	0,04 – 0,15
											3	0,08 – 0,20
											4	0,10 – 0,20
											6	0,12 – 0,28
 <p>CE4 – Grooving and parting off operations – Moderate to high feed rates – Excellent chip constriction – Stable cutting edge</p>		●●	●	●●	●	●	●	●			1,5	0,05 – 0,13
											2	0,06 – 0,15
											3	0,09 – 0,30
											4	0,10 – 0,32
											6	0,12 – 0,40

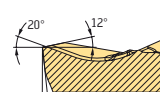
GX system for grooving and parting off





Geometry	Remarks/ field of applications	Workpiece material group							Section of main cutting edge	View Main cutting edge	s [mm]	f [mm]
		P Steel	M Stainless steel	K Cast iron	N NF metals	S Materials with difficult cutting properties	H Hard materials	O Other				
 <p>CF6 – Low feed rate – Low burr/centre pip formation – Low cutting force</p>		●●	●●		●●	●●		●			1,5	0,03 – 0,10
											2	0,03 – 0,12
											2,5	0,03 – 0,15
											3	0,04 – 0,20
 <p>CF5 – Grooving and parting off operations – Light to moderate feed rates – Good chip control – Low burr/centre pip formation</p>		●●	●●	●	●●	●●		●			2	0,04 – 0,15
											2,5	0,05 – 0,15
											3	0,08 – 0,20
											4	0,10 – 0,22
											5	0,10 – 0,25
 <p>CE4 – Grooving and parting off operations – Moderate to high feed rates – Excellent chip constriction – Stable cutting edge</p>		●●	●	●●	●	●	●	●			2	0,06 – 0,15
											2,5	0,07 – 0,18
											3	0,09 – 0,30
											4	0,10 – 0,32
											6	0,12 – 0,40

●● Primary application
● Other application



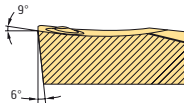

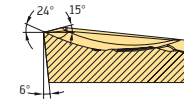

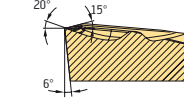

Geometry overview of cutting inserts

(continued)

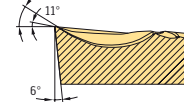
GX system for grooving and parting off

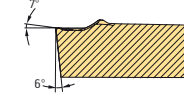
Geometry	Remarks/ field of applications	Workpiece material group							Section of main cutting edge	View Main cutting edge	s [mm]	f [mm]
		P Steel	M Stainless steel	K Cast iron	N NF metals	S Materials with difficult cutting properties	H Hard materials	O Other				
 <p>GD3 – Extremely soft cutting action – Light to moderate feed rates – General parting off and grooving operations</p>		●●	●●	●	●	●		●			2	0,04–0,12
											2,5	0,04–0,14
											3	0,06–0,18
											4	0,10–0,20
											5	0,12–0,25
 <p>GD6 – Moderate feed rates – Long-chipping materials – Medium machining conditions</p>		●●	●●	●	●	●●					2	0,04–0,12
											2,5	0,06–0,17
											3	0,08–0,18
											4	0,10–0,22
											5	0,12–0,24
6	0,14–0,30											

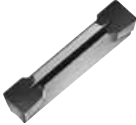
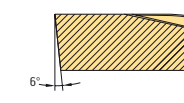
GX system for grooving, parting off and recessing



Geometry	Remarks/ field of applications	Workpiece material group							Section of main cutting edge	View Main cutting edge	s [mm]	a _p [mm]	f [mm]
		P Steel	M Stainless steel	K Cast iron	N NF metals	S Materials with difficult cutting properties	H Hard materials	O Other					
 <p>UD6 – Grooving in rust-resistant steel – Average feed range – Soft cutting action</p>		●	●●								2	0,30–2,50	0,06–0,15
											2,5	0,30–2,50	0,08–0,14
											3	0,40–3,00	0,10–0,20
											4	0,50–3,50	0,12–0,25
											5	0,50–3,00	0,12–0,30
 <p>UF4 – All grooving operations – Good chip control – Average feed range – Positive cut</p>		●●	●●	●●	●						2	0,30–2,50	0,10–0,15
											2,5	0,30–2,50	0,10–0,18
											3	0,40–3,00	0,10–0,20
											4	0,50–3,50	0,10–0,30
											5	0,50–3,50	0,12–0,35
 <p>UD4 – Large chip breaking area – Optimum chip breaking when machining forged parts – Stable cutting edge – For moderate to high feed rates</p>		●●	●	●●							3	0,4–2,0	0,08–0,20
											4	0,5–2,8	0,10–0,30
											5	0,5–3,0	0,12–0,35
											6	0,6–3,5	0,14–0,40
											8	0,9–4,0	0,14–0,40
 <p>UA4 – For cast iron machining – For medium to high machining parameters – For an extremely high level of process reliability in cast iron machining</p>				●●		●					2	0,30–2,50	0,08–0,15
											2,5	0,30–2,50	0,10–0,20
											3	0,40–3,00	0,10–0,22
											4	0,50–3,50	0,10–0,35
											5	0,50–3,00	0,12–0,35
6	0,60–3,50	0,14–0,40											

●● Primary application
● Other application

Geometry overview of cutting inserts

(continued)

GX system, full radius cutting inserts

Geometry	Remarks/ field of applications	Workpiece material group							Section of main cutting edge	View Main cutting edge	s [mm]	a _p [mm] max	f [mm]
		P Steel	M Stainless steel	K Cast iron	N NF metals	S Materials with difficult cutting properties	H Hard materials	O Other					
 <p>RD4 – For copy turning – Outstanding chip control during grooving – For moderate to high feed rates – Circumference-sintered</p>		••	•	••		•				3	1,50	0,08–0,35	
		••	•	••		•				4	2,00	0,10–0,40	
		••	•	••		•				5	2,50	0,12–0,50	
		••	•	••		•				6	3,00	0,15–0,60	
 <p>RF8 – For copy and relief turning – Circumference fully ground – High surface quality – Stable cutting edge</p>		••	••	•		••				3	0,1–1,5	0,10–0,30	
		••	••	•		••				4	0,1–2,0	0,12–0,45	
		••	••	•		••				5	0,1–2,5	0,15–0,50	
		••	••	•		••				6	0,1–3,0	0,15–0,55	
 <p>RK8 – Polished rake face – Sharp cutting edge – Circumference fully ground – Extremely positive</p>					••		•			6	4,00	0,10–0,30	
					••		•			8	5,00	0,10–0,35	

GX system for grooving of circlip grooves

Geometry	Remarks/ field of applications	Workpiece material group							Section of main cutting edge	View Main cutting edge	s [mm]	f [mm]
		P Steel	M Stainless steel	K Cast iron	N NF metals	S Materials with difficult cutting properties	H Hard materials	O Other				
 <p>Cutting inserts for circlip grooves – Excellent surface quality – All common circlip types – Low burr formation</p>		••	•	••						0,6–1,99	0,05–0,10	
		••	•	••						2–2,99	0,05–0,12	
		••	•	••						3–3,99	0,07–0,14	
		••	•	••						4–4,99	0,07–0,20	
		••	•	••						5–5,99	0,08–0,20	

- Primary application
- Other application

Usage information: Replacing the cutting edge on Walter Cut tools

Mounting SX cutting inserts

Fitting the cutting insert

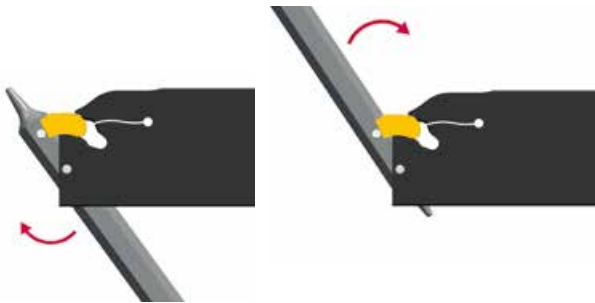

Removing the cutting insert

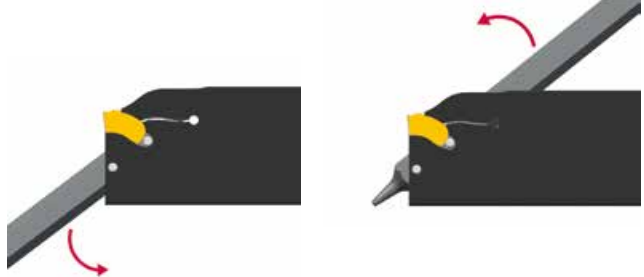

Changing the GX cutting insert

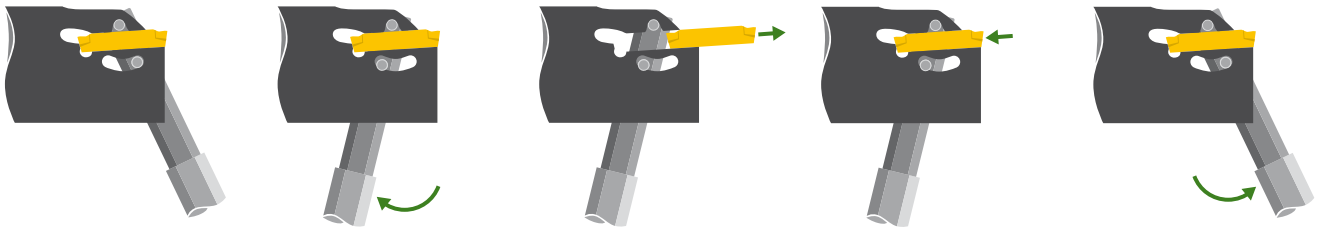

1. Fit the key

2. Open the clamp

3. Remove the old insert

4. Push in the new insert

Walter Cut tool standard/contra version

G2042 / G1041 ... -C

Right-hand version



Standard

Example: G1041.32R-3T32GX24



Contra

Example: G1041.32R-3T32GX24C

Left-hand version



Standard

Example: G1041.32L-3T32GX24



Contra

Example: G1041.32L-3T32GX24C





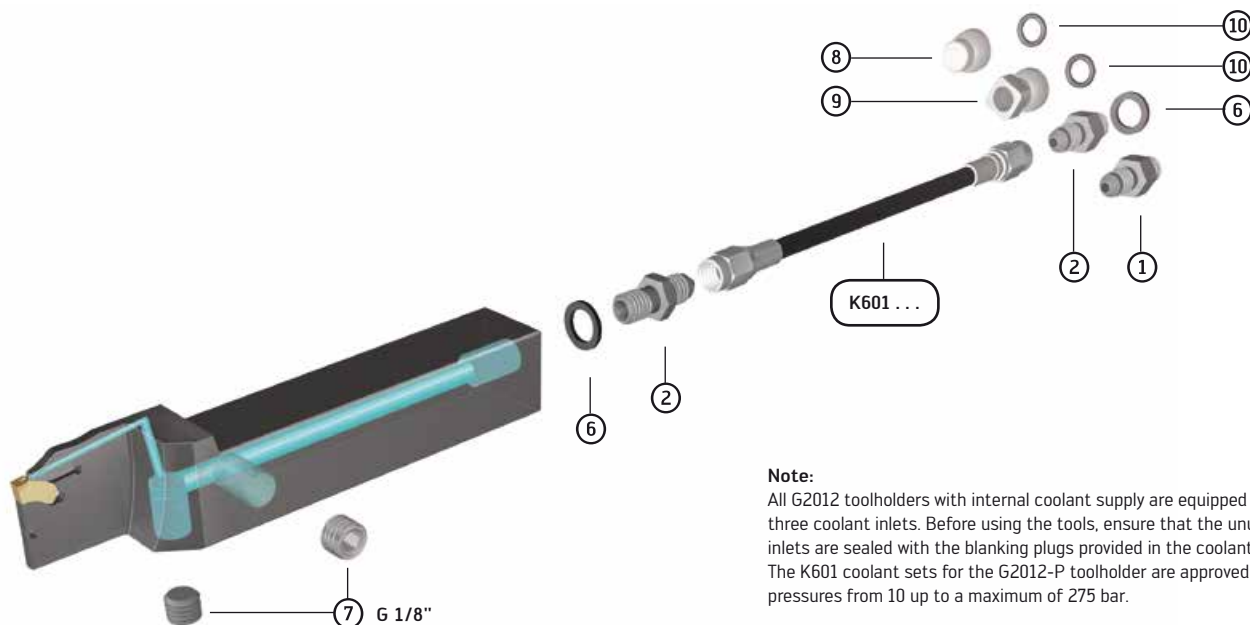







Usage information: Coolant hose set for grooving holders with internal coolant supply

Grooving holder G2012-P



Note:
All G2012 toolholders with internal coolant supply are equipped with three coolant inlets. Before using the tools, ensure that the unused inlets are sealed with the blanking plugs provided in the coolant set. The K601 coolant sets for the G2012-P toolholder are approved for pressures from 10 up to a maximum of 275 bar.

Walter P coolant hose set

Individual components	Designation	Length		
		150 mm	250 mm	300 mm
				
		K601.01.150 SET	K601.02.150 SET	K601.03.150 SET
		K601.01.250 SET	K601.02.250 SET	K601.03.250 SET
		K601.01.300 SET	K601.02.300 SET	K601.03.300 SET
		Number per set		
① 	M10 connection element FS2252	1 x	—	—
② 	1/8" double connection element FS2253	2 x	1 x	—
③ 	1/8" angle connection FS2254	—	1 x	1 x
④ 	M10 angle connection FS2255	—	1 x	2 x
⑤ 	1/4" – 1/8" reduction adaptor FS2256	—	1 x	1 x
⑥ 	Copper gasket FS2257	2 x	3 x	4 x
⑦ 	1/8" blanking plug FS2258	1 x	1 x	1 x
⑧ 	Brass blanking plug FS2259	1 x	1 x	1 x
⑨ 	1/8" brass nozzle FS2260	1 x	1 x	1 x
⑩ 	O-ring FS2261	2 x	2 x	2 x



User Guide – Parting off

1. Basic principles

General

It is essential to note that the most stable tool possible should be selected. This can reduce vibration and increase tool life.

Insert width

The insert width should be as narrow as possible but as wide as necessary. By reducing the insert width, the cutting force is reduced and workpiece material also saved.

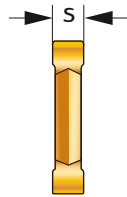

Cutting depth

1. The max. cutting depth [Tmax] of the tool and the max. clamping length of the insert holder should not exceed 10 x insert width [s]. As small a grooving depth as possible should always be selected.

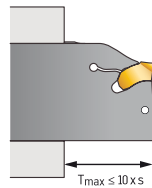

2. Double-edged Walter Cut GX indexable inserts are the most efficient option when the maximum cutting depth does not exceed the second cutting edge. At a deeper cutting depth, single-edged Walter Cut SX cutting inserts are first choice.

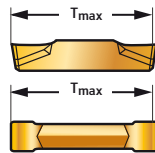

1. Use a neutral cutting edge where possible

- Improved chip formation
- Lower axial forces
- Longer tool life

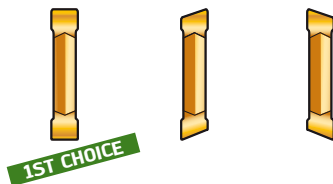

2. Use the smallest insert width possible

- Lower cutting force
- Reduced workpiece material consumption

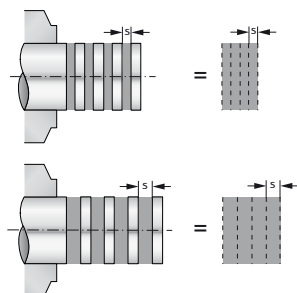

3. Use the largest tool possible – in relation to the height of the body [h]

- Greater tool rigidity
- Reduced risk of vibration
- Longer tool life

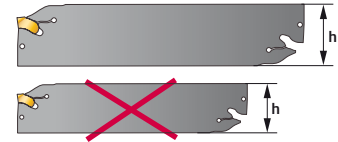

Effect of the lead angle on machining

In order to determine the hand of the cutting inserts (right/left), unlike the tools, which are viewed from the front, the insert is viewed from above.

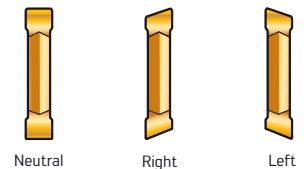

The following rule applies:

Direction of rotation of the machine spindle:
 Clockwise → right cutting insert
 Anticlockwise → left cutting insert

When parting off solid material, the use of inserts with lead angles reduces the formation of a 'pip' remaining on the component that has been parted off.

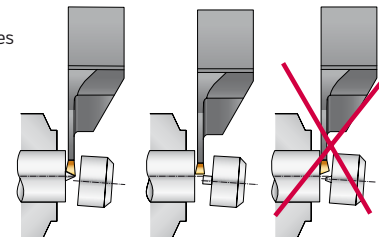

When parting off tubular material, the use of inserts with lead angles prevents the creation of rings which may remain on the parted off component and interfere with the rest of the manufacturing process. It also leads to lower burr formation.

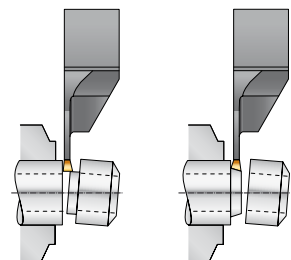

The use of inserts with lead angles always has a negative effect on the cutting insert tool life. If possible, neutral inserts should be used.

1. Basic principles *(continued)*

(Continued: 2. Effect of the lead angle on machining)

When inserts with lead angles are used for parting off, the angle is likely to be detrimental to chip formation.

The swarf rolls at 90° to the main cutting edge, thereby not taking on a clockspring shape (as with a neutral insert), but instead, that of a spiral coil.

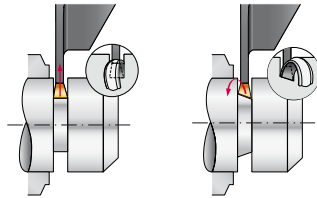

One possibility for guiding the swarf is to interrupt cutting briefly once a cutting depth of 1-2 x insert width [s] is reached. Once cutting resumes, the chip will flow in the existing groove.

The feed values must be reduced by approximately 30%, because the tool tends to wander as a result of the axial force created (Fn). This can lead to vibration and convex machined surfaces.

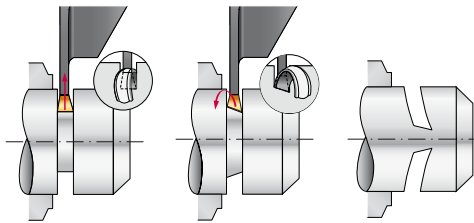

Effects on machining

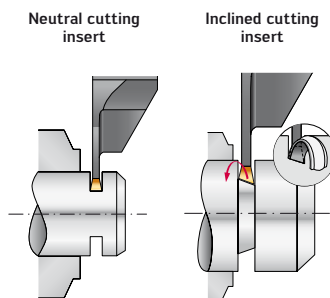

Stability and tool life	Good	Poor
Radial cutting forces (positive)	High	Low
Axial cutting forces (negative)	Low	High
Remaining pip / burr	Large	Small
Risk of vibration	Low	High
Surface finish quality and flatness	Good	Poor
Chip flow	Good	Poor

2. User tips

Tool must be aligned 90° to the axis of rotation

- Better machined face flatness
- Reduced vibration tendency

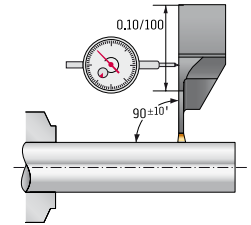

Check the centre height

- Longer/more consistent tool life
- Reduced pip/burr formation

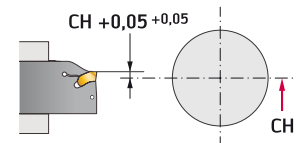

If the tool is positioned over or under centre, the effective rake and front clearance angles change during machining.

Set the tool in the machine with the shortest possible overhang

- Better machined face flatness
- Reduced vibration tendency
- Improved tool life

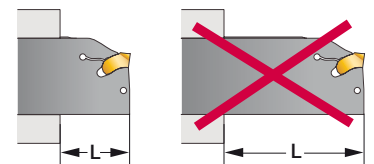

Clamp the workpiece as short as possible

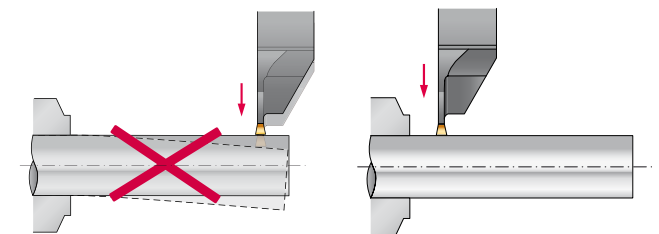

Reducing the feed rate

Under a diameter of 1.5 x width mm, reduce the feed rate [f] by approx. 50 – 75%.

Do not machine past the centre, as there is a risk of fracture.

It is possible to machine past the centre to a maximum of corner radius +0.1 mm.

For example, corner radius 0.3 mm

x = -0.4 mm

Constant cutting speed with speed limitation

(e.g. max. bar loader RPM)

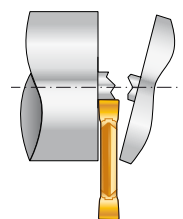



User Guide – Parting off

2. User tips *(continued)*

Grooving on inclined surfaces

When grooving on inclined surfaces, the feed rate for the chamfer must be reduced by approx. 20% - 50% and a sharper geometry must be used (e.g. CF5).

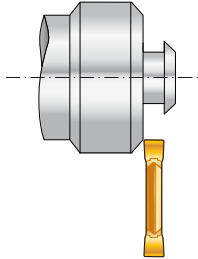

Retracting the tool

After parting off, do not retract the tool immediately. First, move away from the parted face in the axial direction and then radially retract.

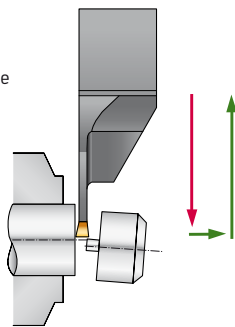

Chamfering and parting off

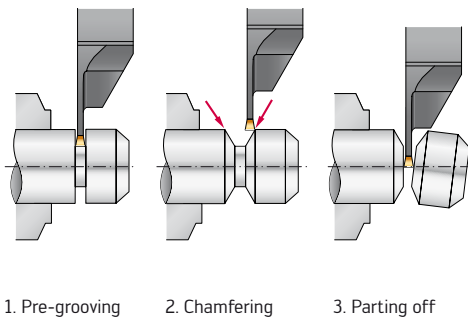

Chamfering internally before parting off

The corner cutting edge of the chamfering tool and the corresponding parting off tool must be precisely aligned to achieve as burr-free a result as possible.

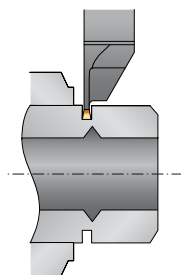

Parting off into a bore

The hole must be pre-bored deep enough so that the entire insert width of the parting off tool exits in the cylindrical section of the hole.

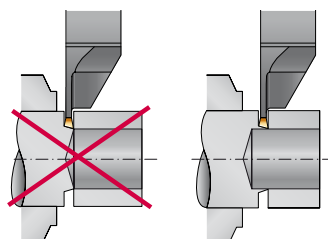

Reinforced blades for application conditions

"Overhead" mounting position Contra blade

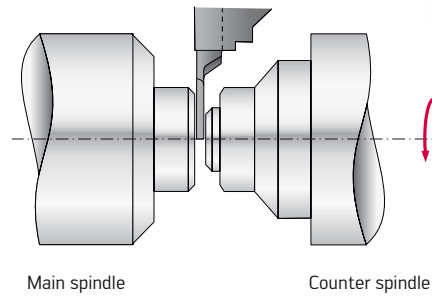

G2042.32.R-3T33 SX-C

Anticlockwise

"Normal" mounting position

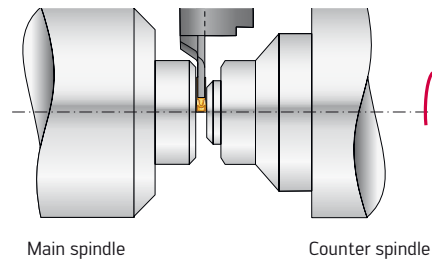

G2042.32.R-3T33 SX

M3 clockwise rotation

"Normal" mounting position Contra blade

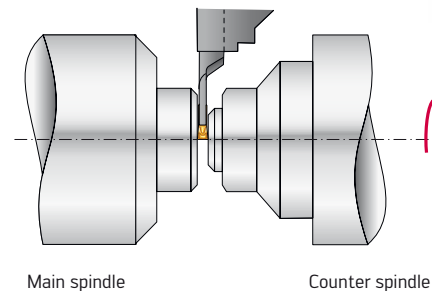

G2042.32.L-3T33 SX-C

M3 clockwise rotation

3. Fault analysis



Large residual pip / burr

- Reduce the feed value by 50 - 75% from below diameter $1.5 \times s$ (s = insert width)
- Use an insert with lead angle
- Use a narrower insert (reduction of the cutting forces)
- Use a smaller corner radius
- Use a more positive geometry
- Check the centre height



Poor surface / vibration

- Use a more stable tool
- Clamp the tool with a shorter overhang.
- Check whether the insert seat is damaged
- Use a more positive geometry
- Increase the feed rate



Damage caused by swarf

- Use a chip breaker with greater chip constriction
- Lower the cutting speed
- Use a straight cutting insert
- Optimise cooling
- Increase the feed rate



Poor chip formation

- Lower the cutting speed
- Improve cooling
- Check the chip breaker
- Increase the feed rate

Poor face flatness

- Use an insert with as small a lead angle as possible or no lead angle at all.
- Use a tool with the shortest possible cutting depth for the application
- Reduce the feed rate for inserts with a lead angle.
- Use a smaller corner radius
- Use a more positive geometry
- Align the tool correctly

Chip formation when parting off

- Chip constriction inhibits friction on the side walls of the tool and reduces chip accumulation
- Enables higher feed rates
- No damage to parted off surfaces
- Chips are rolled up helically and broken short, so that they can exit the groove with ease



User Guide – Grooving

1. Basic principles

General

The use of recessing tools allows machining steps to be grouped together, saving on the number of tools used.

These tools are used for machining between shoulders or when tool positions are limited.

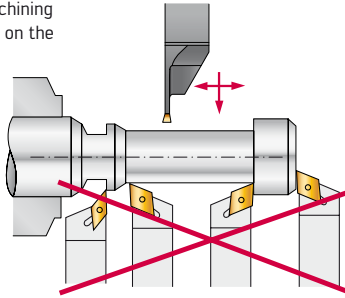

A precise form-fit connection between the insert and the insert seat enables both radial and axial forces to be absorbed.



This precise form fit allows grooving and longitudinal turning operations when special chip forming geometries are used. The universal geometries are perfectly suited for this, e.g. UD4, UF4.

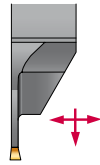

Machining process strategy

We always distinguish between two production strategies: Grooving and recessing.

For **grooving**, the feed moves in only one direction. Longitudinal turning with low material removal (approx. 0.1 - 0.3 mm) takes place only as a finishing pass.

Grooving

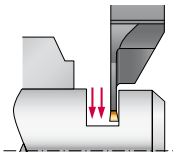

Recessing

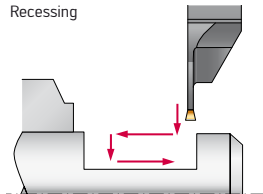

Recessing is a combination of grooving and longitudinal turning movements.

Grooving or recessing?

The choice of machining strategy depends on the shape and size of the groove to be produced. As a general rule, the following criteria can be used to make a decision:

Recessing: The groove width is 1.5 times greater than the groove depth

Grooving: The groove depth is 1.5 times greater than the groove width

Recessing

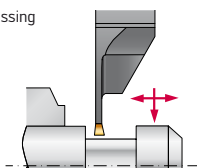

Grooving

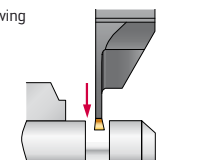

2. User tips

For grooving, only one cutting edge is used.

Here, it is also necessary to adhere to certain machining sequences to achieve an optimum result.

Producing a small groove with chamfer

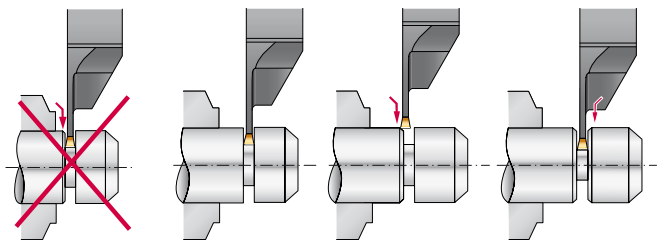

Grooving with 0.1 mm machining allowance on the diameter

Turn the chamfer and finish first groove wall

Turn the chamfer and finish second groove wall

Producing a wide groove by grooving

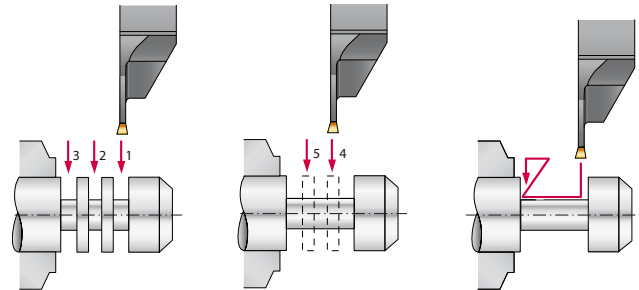

Pre-grooving
Web width = $s - 2 \times r$

Pre-grooving

Finishing
 $a_{p\max} = r$

s = insert width / r = corner radius / $a_{p\max}$ = max. cutting depth

Side offset [s]–[r]

For side offset grooving, a universal "U" geometry should be used if possible. It is important to ensure that the grooving width is at least between $s/2$ and insert width $s-1 \times r$.

a_p min: $0.5 \times s$
 a_p max: $s-r$

Example:
 $s = 3.0$ mm
 $r = 0.2$ mm
 a_p min: 1.5 mm
 a_p max: 2.8 mm

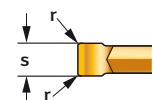
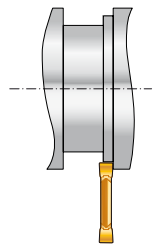



User Guide – Recessing

1. Basic principles

Tool must be aligned 90° to the axis of rotation.

This is the only way to guarantee that a clearance angle can be generated when the groove is turned in both directions. Poor tool alignment leads to vibration and can cause tool breakage.

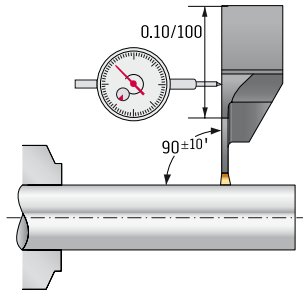

Deflection

Deflection means the deformation of the insert blade support caused by a force [F_p]. This deflection is required in order to generate an adjacent clearance angle [α] during the longitudinal turning operation.

The degree of deflection is influenced by multiple factors:

- Cutting depth [a_p]
- Feed [f]
- Cutting speed [v_c]
- Corner radius [r]
- Workpiece material to be machined
- Cutting depth of the tool [T]
- Width of the insert support blade

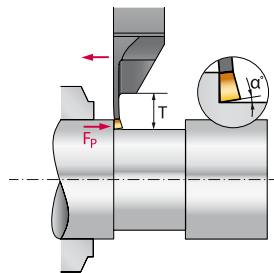

Diameter compensation

The deflection causes different longitudinal ratios on the tool. In order to generate an even diameter during finishing, a diameter compensation must take place at the transition from grooving to the longitudinal turning movement.

1. Pre-machine the component up to the finishing operation
2. Groove to the final diameter
3. Retract by 0.1 mm
4. Turn longitudinally
5. Measure the groove diameter and turned diameter and correct the retraction dimension (0.1 mm) by the difference in diameter.

Recessing surface finish quality in comparison to ISO turning

A "wiper effect" is generated by deflecting the cutting insert when recessing. This is shown in image A.

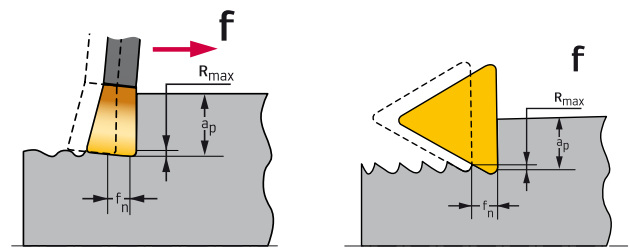
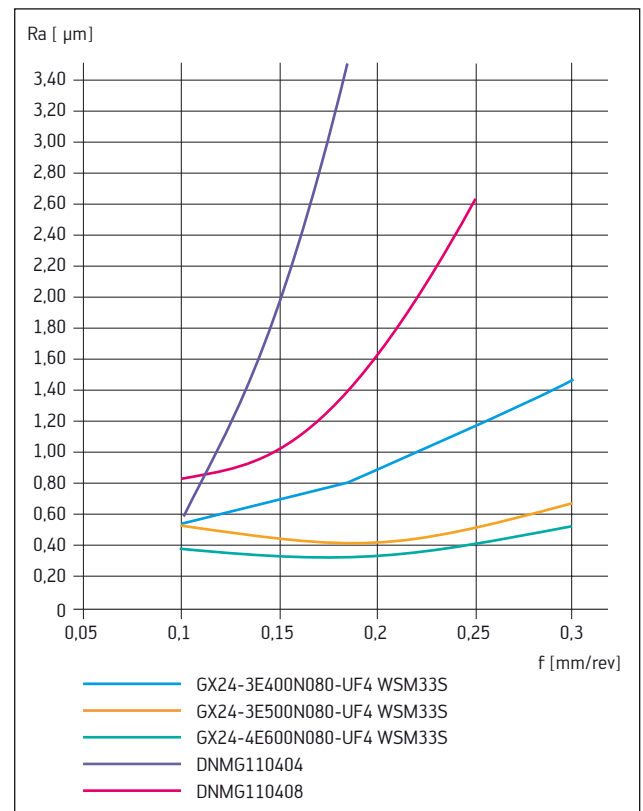

Image A

Comparison of the surface finish quality for recessing and ISO turning





User Guide – Recessing

2. User tips

Recessing

In order to ensure a reliable machining process, certain tool paths must be adhered to. For instance, a tool must not be stressed by cutting in two directions at the same time. At all times, ensure that the cutting edge is relieved after grooving before you start the longitudinal turning operation. Transition from longitudinal turning to grooving applications requires the cutting edge to be relieved in the same way.

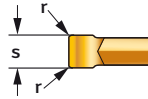
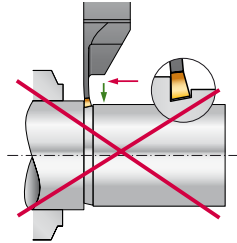

General rule for recessing:

- f_{start} 0.05 x s
- f_{max} 0.07 x s
- a_{pmin} R + 0.1 mm
- a_{pmax} 0.7 x s

Machining sequence

At the end of the longitudinal turning operation, retract opposite the direction of feed and away from the machined diameter by at least 0.1 mm. This clearance allows the cutting edge to return to its original position.

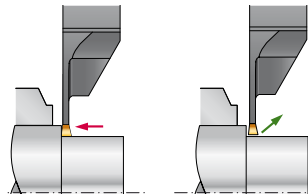

The next grooving operation can now follow. Before you transition to the longitudinal turning operation at this point, retract 0.1 mm again.

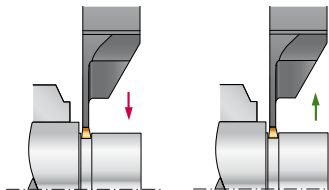

Avoidance of ring formation

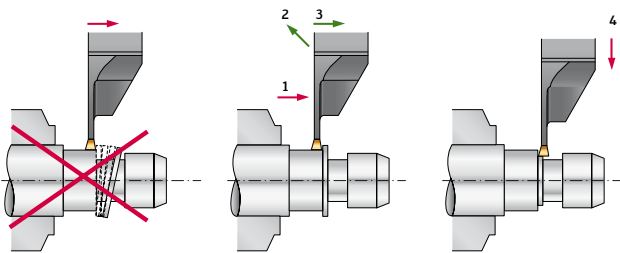

1. Longitudinally turn to approx. 0.5 - 1.5 mm before the end of planned cut path
2. Retract at an angle away from the corner
3. Position the tool above the remaining ring
4. Remove the ring in a plunge grooving application

Cutting a recess

1. Roughing

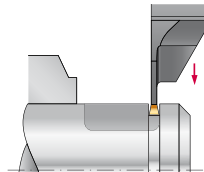

1. Grooving (to the depth of your first longitudinal pass)
2. Retract by 0.1 mm

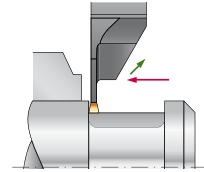

3. Turn longitudinally
4. Retract by 0.1 mm in two directions

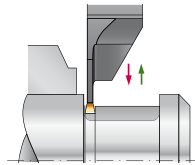

5. Groove again
6. Retract by 0.1 mm

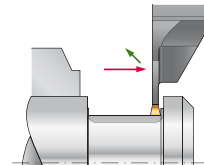

7. Turn longitudinally to approximately 0.5 mm before the shoulder
8. Retract by 0.1 mm in two directions

2. Finishing

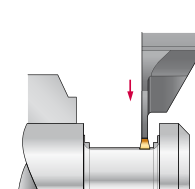

1. Groove at the radius tangent point (end of the component radius) down to the required finished diameter

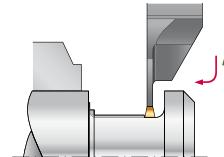
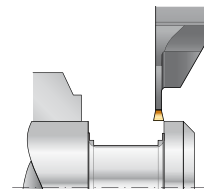

2. Finishing turn the first shoulder and the required radius
3. Retract by the diameter compensation dimension (ref: page 69)

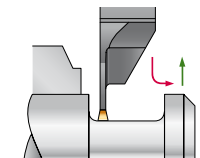
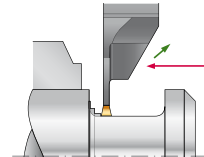

4. Turn longitudinally to the remaining radius tangent position (radius start point)
5. Retract 0.1 mm in two directions
6. Finishing turn the second shoulder and the required radius

2. User tips (continued)

Preventing vibration when copy turning

- The radius of the indexable insert should always be smaller than the required workpiece radius
- When machining the workpiece radius, reduce the feed rate by 50% in comparison to the feedrate on the straight longitudinal cut

Insert radius = workpiece radius
Not recommended!

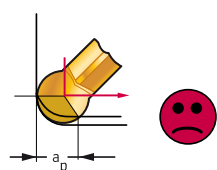

Insert radius < workpiece radius
Recommended!

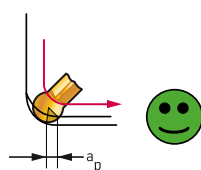

f_{n1} = longitudinal cut – max. chip thickness 0.15 - 0.40 mm
 f_{n2} = radius machining – 50% max. chip thickness

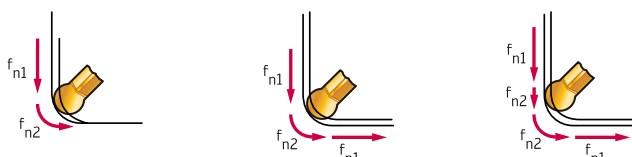

Tool set up

- Before inserting the insert, you should check that the insert seat is free from dirt and damage

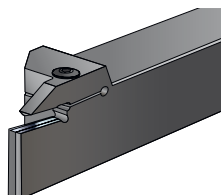

- Push the cutting insert along the location faces into the insert seat and check for resistance

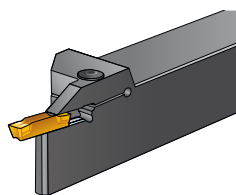

- To tighten the clamping screw, use the screwdriver provided. We recommend using a torque wrench. The following clamping screw torque values are recommended :

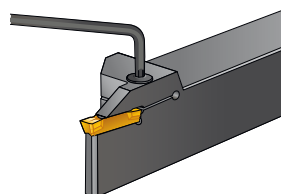

Tool	Tightening torque
G15 ..	5.0 Nm
G1011	5.0 Nm
G1111	4.0 Nm
G1041	3.5 Nm
XLDE	3.5 Nm

3. Recessing – Fault Analysis

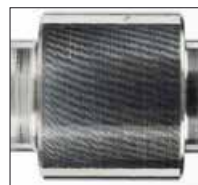

Vibration during longitudinal turning

- Check tool alignment (see page 65)
- Deflection of cutting insert too low (see page 65)
- Use narrower insert (easier to deflect)
- Use a smaller corner radius
- Shorten workpiece overhang



Step in machined diameter

- Verify and correct retraction dimension before finishing cut
- Ensure even material removal
- Check whether the insert seat is damaged
- Increase the cutting speed
- Use a more positive geometry



Damage caused by swarf

- Use a chip breaker with greater chip constriction
- Lower the cutting speed
- Optimise cooling



Ring formation

- Check the program sequence (see page 70)

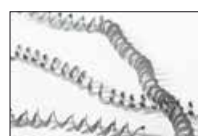

Poor chip formation

- Lower the cutting speed
- Increase the feed rate
- Improve cooling
- Check the chip breaker for damage
- Check geometry selection



User Guide – Axial grooving

Basic principles

Selecting a tool design

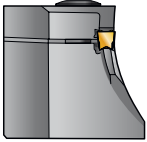

Right-hand tool

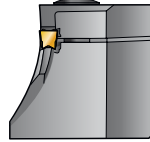

Left-hand tool

Select the largest possible diameter range for the first groove

The larger the diameter range of the first groove, the better the chip evacuation

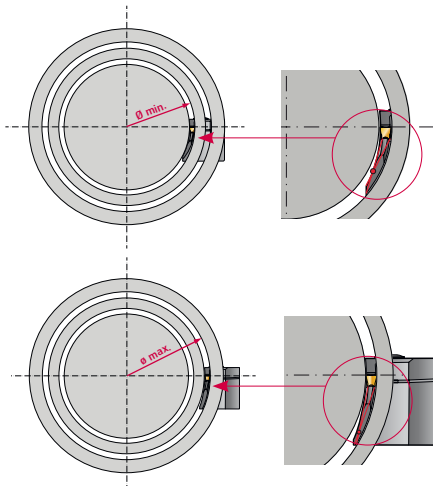

Expanding an axial groove

1. First groove on the largest possible diameter

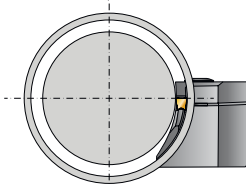

2. Expanding inwards

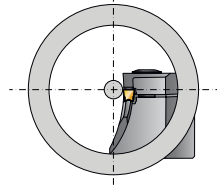

3. Expanding outwards

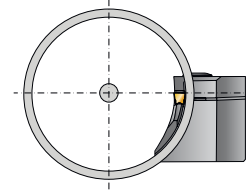

General grooving

Wear analysis

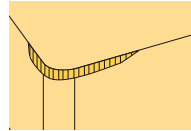

Flank face wear

- Use a more wear-resistant cutting material
- Reduce the cutting speed
- Improve cooling

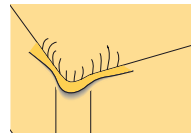

Plastic deformation

- Use a more wear-resistant cutting material
- Reduce feed
- Optimise cooling
- Reduce the cutting speed

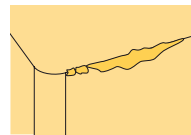

Fractures

- Use tougher grades of carbide
- Use a more stable tool
- Use a more stable geometry
- Use wider inserts if necessary

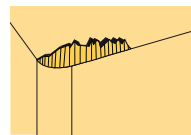

Built up edge

- Increase the cutting speed
- Use a more positive geometry
- Optimise cooling

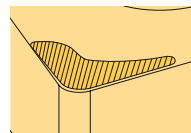

Crater wear

- Reduce the cutting speed
- Use a more positive geometry
- Use a more wear-resistant cutting material
- Optimise cooling

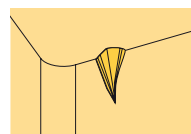

Notching or oxidation wear

- Reduce the cutting speed
- Reduce feed rate

Cutting depths relative to turned outer diameter

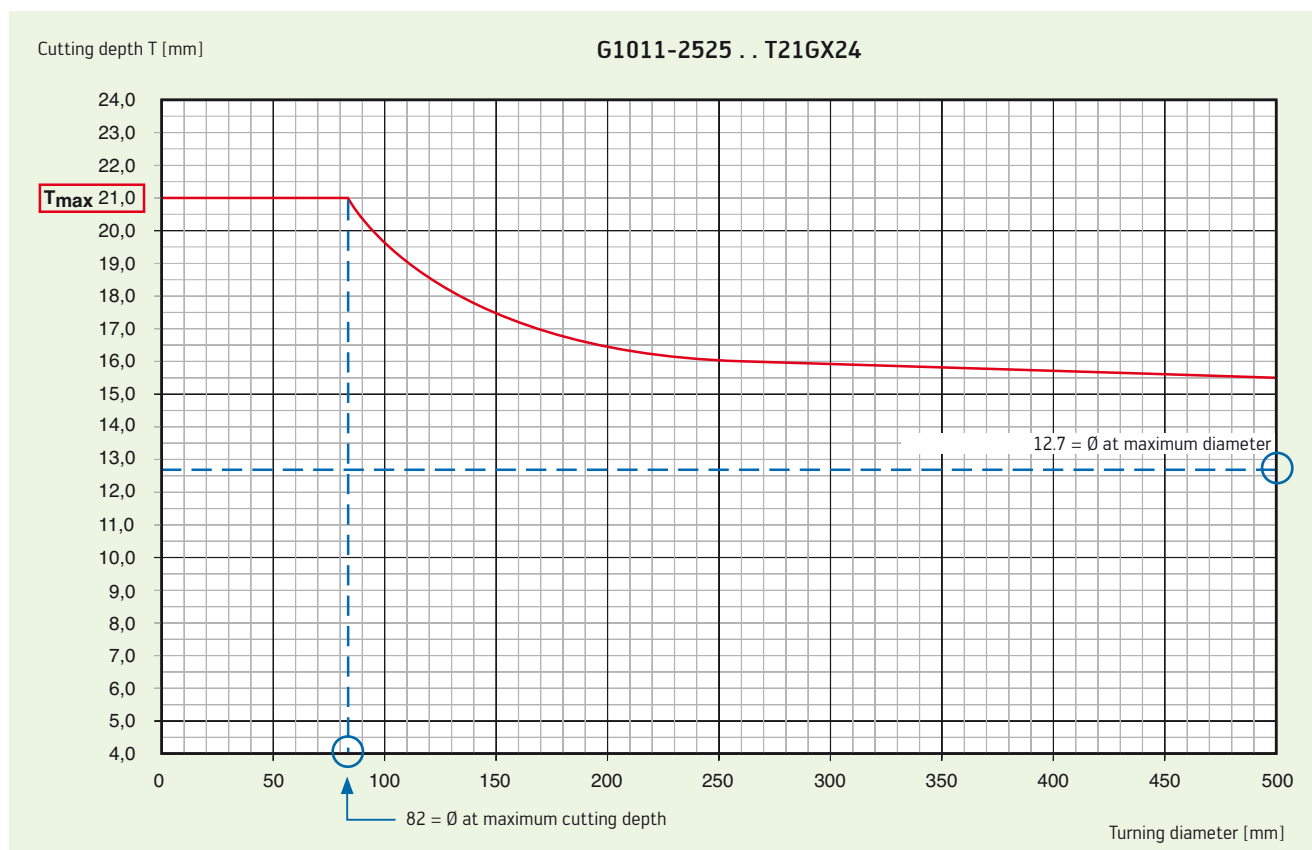
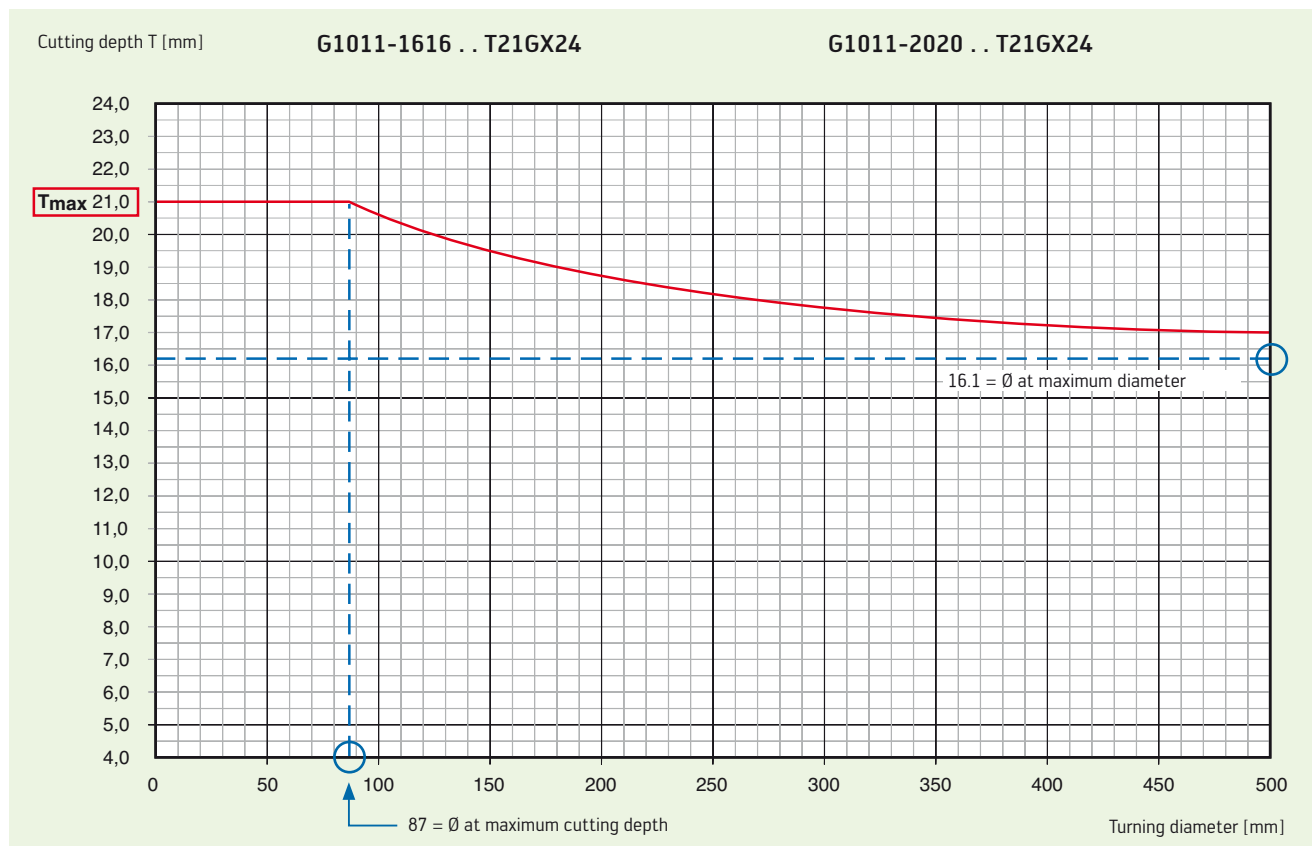

Hardness comparison table Tensile strength, Brinell, Vickers and Rockwell hardness (extract from DIN 50150)

Tensile strength Rm N/mm ²	Vickers hardness HV	Brinell hardness HB	Rockwell hardness HRC
255	80	76,0	
270	85	80,7	
285	90	85,5	
305	95	90,2	
320	100	95,0	
335	105	99,8	
350	110	105	
370	115	109	
385	120	114	
400	125	119	
415	130	124	
430	135	128	
450	140	133	
465	145	138	
480	150	143	
495	155	147	
510	160	152	
530	165	156	
545	170	162	
560	175	166	
575	180	171	
595	185	176	
610	190	181	
625	195	185	
640	200	190	
660	205	195	
675	210	199	
690	215	204	
705	220	209	
720	225	214	
740	230	219	
755	235	223	
770	240	228	20,3
785	245	233	21,3
800	250	238	22,2
820	255	242	23,1
835	260	247	24,0
850	265	252	24,8
865	270	257	25,6
880	275	261	26,4
900	280	266	27,1
915	285	271	27,8
930	290	276	28,5
950	295	280	29,2
965	300	285	29,8
995	310	295	31,0
1030	320	304	32,2
1060	330	314	33,3
1095	340	323	34,4
1125	350	333	35,5
1155	360	342	36,6
1190	370	352	37,7
1220	380	361	38,8
1255	390	371	39,8
1290	400	380	40,8
1320	410	390	41,8
1350	420	399	42,7
1385	430	409	43,6

Tensile strength Rm N/mm ²	Vickers hardness HV	Brinell hardness HB	Rockwell hardness HRC
1420	440	418	44,5
1455	450	428	45,3
1485	460	437	46,1
1520	470	447	46,9
1555	480	(456)	47,7
1595	490	(466)	48,4
1630	500	(475)	49,1
1665	510	(485)	49,8
1700	520	(494)	50,5
1740	530	(504)	51,1
1775	540	(513)	51,7
1810	550	(523)	52,3
1845	560	(532)	53,0
1880	570	(542)	53,6
1920	580	(551)	54,1
1955	590	(561)	54,7
1995	600	(570)	55,2
2030	610	(580)	55,7
2070	620	(589)	56,3
2105	630	(599)	56,8
2145	640	(608)	57,3
2180	650	(618)	57,8
	660		58,3
	670		58,8
	680		59,2
	690		59,7
	700		60,1
	720		61,0
	740		61,8
	760		62,5
	780		63,3
	800		64,0
	820		64,7
	840		65,3
	860		65,9
	880		66,4
	900		67,0
	920		67,5
	940		68,0

The hardness values converted in accordance with these tables are approximate only. See DIN 50150.

Material property	Unit / test method	Formula symbol
Tensile strength	N/mm ²	R _m
Vickers hardness	Diamond pyramid 136° Testing force F ≥ 98 N	HV
Brinell hardness Calculated from: HB = 0.95 x HV	$0.102 \times F/D^2 = 30 \text{ N/mm}^2$ F = Testing force in N D = Sphere diameter in mm	HB
Rockwell hardness C	Diamond cone 120° Overall testing force 1471 ± 9 N	HRC

Grooving calculation formulae

Speed

$$n = \frac{v_c \times 1000}{D_c \times \pi} \quad [\text{min}^{-1}]$$

Cutting speed

$$v_c = \frac{D_c \times \pi \times n}{1000} \quad [\text{m/min}]$$

Feed rate

$$v_f = n \times f \quad [\text{mm/min}]$$

Metal removal rate

$$Q = v_c \times a_p \times f \quad [\text{cm}^3/\text{min}]$$

Cutting time

$$t_h = \frac{l_m}{f \times n} \quad [\text{min}]$$

Power requirements depending on $m_c/k_{c1.1}$

$$P_{\text{mot}} = \frac{v_c \times f \times a_p \times k_c}{60000 \times \eta} \quad [\text{kW}]$$

$$k_c = \frac{1 - 0,01 \times \gamma_0}{h^{m_c}} \times k_{c1.1} \quad [\text{N/mm}^2]$$

$$h = f \times \sin \kappa$$

General rule

for a "quick" calculation of power required

Steel:
$$P_{\text{mot}} = \frac{v_c \times f \times a_p}{20} \quad [\text{kW}]$$

Cast iron:
$$P_{\text{mot}} = \frac{v_c \times f \times a_p}{25} \quad [\text{kW}]$$

Aluminium:
$$P_{\text{mot}} = \frac{v_c \times f \times a_p}{100} \quad [\text{kW}]$$

n	Speed	rpm
D_c	Turning diameter	mm
v_c	Cutting speed	m/min
v_f	Feed rate	mm/min
f	Feed per revolution	mm
Q	Metal removal rate	cm ³ /min
a_p	Depth of cut	mm
h	Chip thickness	mm
κ	Lead angle	°
$k_{c1.1}^*$	Specific cutting force For 1 mm ² chip cross section	N/mm ²
m_c^*	Increase in the k_c curve	
P_{mot}	Drive power	kW
t_h	Cutting time	min
l_m	Length of cut	mm
η	Machine efficiency	(0.75 - 0.9)

* m_c and $k_{c1.1}$ see table on page 76.

Cutting forces of Walter machining groups

Description	Tensile strength		Spec. cutting force	Increase value	Walter machining group
	min	max			
	R _m [N/mm ²]		k _{c1.1} [N/mm ²]	m _c	
Non-alloyed and low-alloy steels, C > 0.25 %, low and medium tensile strength	350	750	1500	0,21	P1, P6
Non-alloyed and low-alloy steels, C > 0.55 %, not tempered	400	900	1700	0,25	P2, P3, P4, P7, P14
Low and high-alloy steels, low tempering level	750	1100	2000	0,25	P5, P8, P11, P12
Stainless ferritic/martensitic steels, tempered	800	1400	2200	0,25	P15
Low and high-alloy steels, medium tempering level	1100	1400	2500	0,25	P9
Low and high-alloy steels, high tempering level	1200	1600	3000	0,25	P10, P13
Stainless, austenitic steels	400	900	1800	0,21	M1
Stainless, austenitic/ferritic steel + duplex	600	1000	2000	0,21	M3
Stainless, austenitic steels, precipitation hardened (PH steels)	700	1500	2400	0,21	M2
Grey cast iron + CGI + malleable cast iron, low tensile strength	200	400	800	0,28	K1, K3, K7
Ductile cast iron low tensile strength + malleable cast iron with higher tensile strength	400	600	950	0,28	K2, K5
Grey cast iron with higher tensile strength	300	400	1200	0,28	K4,
Ductile cast iron with high tensile strength + ADI high tensile strength, non-alloyed + alloyed	600	800	1400	0,28	K6
Aluminium wrought alloy, not hardened			350	0,25	N1
Aluminium wrought alloy, hardened			600	0,25	N2
Cast aluminium alloy < 12% Si, not hardened			600	0,25	N3
Cast aluminium alloy < 12% Si, hardened, cast aluminium alloy ≥ 12%			700	0,25	N4, N5
Pure copper, copper alloy (brass, bronze) with low tensile strength			550	0,25	N7, N8, N9
High tensile strength copper alloy, bronze with high tensile strength			1000	0,25	N10
Heat-resistant alloys, iron-based, annealed			2400	0,25	S1
Heat-resistant alloys, iron-based, hardened			2500	0,25	S2
Pure titanium			1300	0,25	S6
Titanium alloys, alpha, alpha/beta and beta alloys			1500	0,25	S7, S8
Heat-resistant alloys, nickel-cobalt-based, annealed			2800	0,25	S3
Heat-resistant alloys, nickel-cobalt-based, hardened			2900	0,25	S4
Heat-resistant alloys, nickel-cobalt-based, cast			3000	0,25	S5
Hardened steels 46 – 52 HRC			3000	0,25	H1
Hardened steels 52 – 58 HRC			3700	0,25	H2
Hardened steels 58 – 62 HRC			4300	0,25	H3
Hardened cast iron 50 – 60 HRC			3500	0,25	H4
Thermoplasts and thermosetting plastics, without abrasive fillers			150	0,2	O1, O2
Fibre-reinforced plastics			300	0,3	O3, O4, O5
Graphite			400	0,25	O6

Comments:

The information consists of guideline values and relates to neutral cutting edge geometry.

The condition of the workpiece material and the cutting edge geometry have considerable influence on the cutting forces.

Walter AG

Derendinger Straße 53, 72072 Tübingen
Postfach 2049, 72010 Tübingen
Germany

www.walter-tools.com

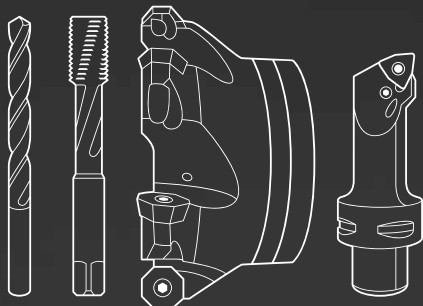

Walter GB Ltd.

Bromsgrove, England
+44 (1527) 839 450, service.uk@walter-tools.com

Walter Kesici Takımlar Sanayi ve Ticaret Ltd. Şti.

Istanbul, Türkiye
+90 (216) 528 1900 Pbx, service.tr@walter-tools.com

Walter Wuxi Co. Ltd.

Wuxi, Jiangsu, P.R. China
+86 (510) 8241 9399, service.cn@walter-tools.com

Walter AG Singapore Pte. Ltd.

+65 6773 6180, service.sg@walter-tools.com

Walter Korea Ltd.

Anyang-si Gyeonggi-do, Korea
+82 (31) 337 6100, service.kr@walter-tools.com

Walter Tools India Pvt. Ltd.

Pune, India
+91 (20) 3045 7300, service.in@walter-tools.com

Walter (Thailand) Co., Ltd.

Bangkok, 10120, Thailand
+66 2 687 0388, service.th@walter-tools.com

Walter Malaysia Sdn. Bhd.

Selangor D.E., Malaysia
+60 (3) 8023 7748, service.my@walter-tools.com

Walter Tooling Japan K.K.

Nagoya, Japan
+81 (52) 723 5800, service.jp@walter-tools.com

Walter USA, LLC

Waukesha WI, USA
+1 800-945-5554, service.us@walter-tools.com

Walter Canada

Mississauga, Canada
service.ca@walter-tools.com
