

FEATURING THE LATEST PRODUCTS FROM WIDIA™

# ADVANCES

2019 METRIC



**WIDIA** 

INTRODUCING...

# NEW PRODUCTS

VSM890™-12

pages 4–11

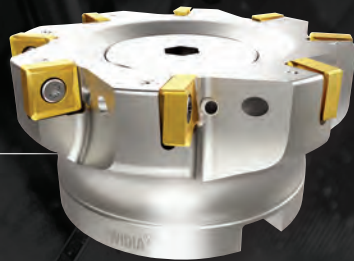

70NS

pages 24–27



VXF™-07

pages 12–17, 21



VXF™-12

pages 12–14, 18–21



WGC

pages 70–87



## INDEXABLE MILLING

4-21

VSM890-12

VXF-07

VXF-12

## SOLID END MILLING

22-35

The VariMill Family

70NS X-Feed

4U50

4U80

General Purpose End Mills

## HOLEMAKING

36-68

TDMX

Top Cut 4

## TURNING

70-87

WGC

## ORDERING INFORMATION

88-91

Informational Icons Guide

Material Overview

Top Cut 4™

pages 46-68

GP

pages 32-35

TDMX™

pages 36-45

4U50

pages 28-30

4U80

pages 28, 31

**WIDIA** 



# COMING SOON!

AN ALL-INCLUSIVE CATALOGUE SHOWCASING  
WIDIA™ TOOLING AND MACHINING STRATEGIES  
THAT REDUCE CYCLE TIME AND INCREASE  
TOOLING COST SAVINGS.



**WIDIA** 

MACHINING **BRILLIANCE**



2019

# AEROSPACE

FEATURING THE BEST  
AEROSPACE COMPONENT  
MACHINING SOLUTIONS  
FROM WIDIA™

**WIDIA**   
MACHINING BRILLIANCE



# VSM890™-12



UNIQUE 8-EDGED SOLUTION FOR  
SHOULDER AND FACE MILLING





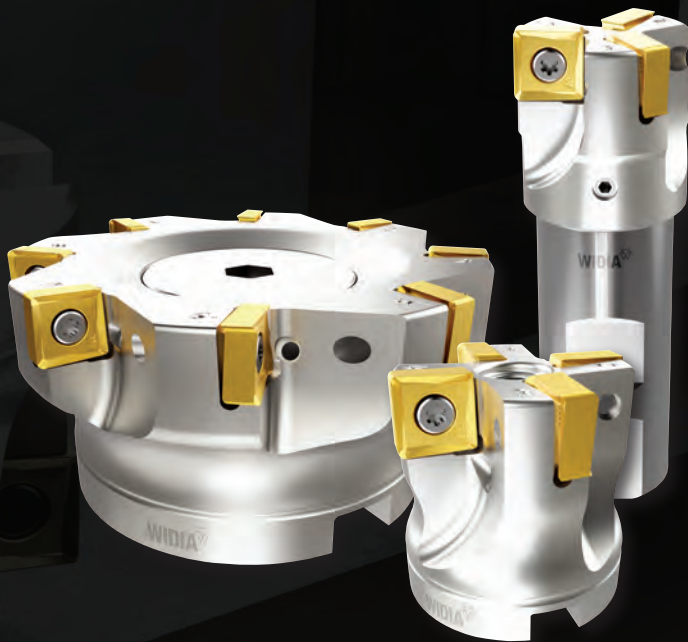

## VSM890™ -12

Weldon® End Mills: 32mm

Shell Mills: 40–250mm

### 8-Edged, Double-Sided True 90° Victory™ Shoulder-Face Mill (VSM)

Superior Metal Removal Rates (MRR) delivered through high-performance grades and chipbreakers.

Coarse, medium, and fine pitch cutter density to perfectly translate machining capability into higher productivity.

New pocket seat design for improved insert seating and great stability at roughing applications.

Applicable in a wide range of workpiece materials: aluminium, steel, cast iron, titanium, stainless steel, and high-temp alloys.

Comprehensive standard offering for cutter bodies and inserts to address light machining to heavy roughing jobs.



Available in the new WU10PM and WS40PM grades.

**WIDIA** 

[widia.com](http://widia.com)

# VSM890™ -12

8-Edged, Double-Sided True 90° Victory™ Shoulder-Face Mill



- True 90° wall and stepping down capability.
- Axial depth of cut capability; Ap1 max up to 9,8mm.
- Optimised chip gash design for proper chip evacuation.
- User-friendly pocket numbering system.
- Cutter bodies with internal coolant supply.
- Less bur creation on the workpiece.

Super-positive rake design for low machine power consumption.

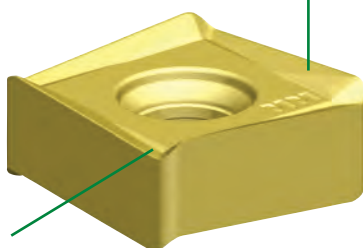

Integrated wiper facet for excellent surface floor finish.

**Unique insert rake design to reduce and perfectly balance axial and radial cutting forces. Engineered for light machining to heavy roughing in all material groups.**

-ALP



**N**

First choice for Non-Ferrous materials.

-ML

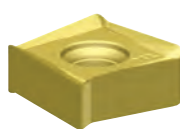

**P M S**

First choice for Stainless Steel, light machining, and finishing jobs.

-MM



**P M K S H**

First choice for general purpose in all workpiece materials. Engineered for high-feed rates.

Finishing Capabilities/Lower Cutting Forces

Geometry Strengthening/Stronger Cutting Edge Protection

## Applications

1. Face milling.
2. Full slotting with 100% radial engagement.
3. Shoulder milling with stepping down and great wall finish.
4. Shoulder milling with low axial and high radial engagement.
5. Shoulder milling with low radial and high axial engagement.
6. HPC face milling. First choice to clean up castings.
7. Dynamic/trochoidal slot milling.
8. Z-axis plunge milling.
9. Z-axis contour plunge milling.
10. Z-axis zig-zag slot plunge milling.

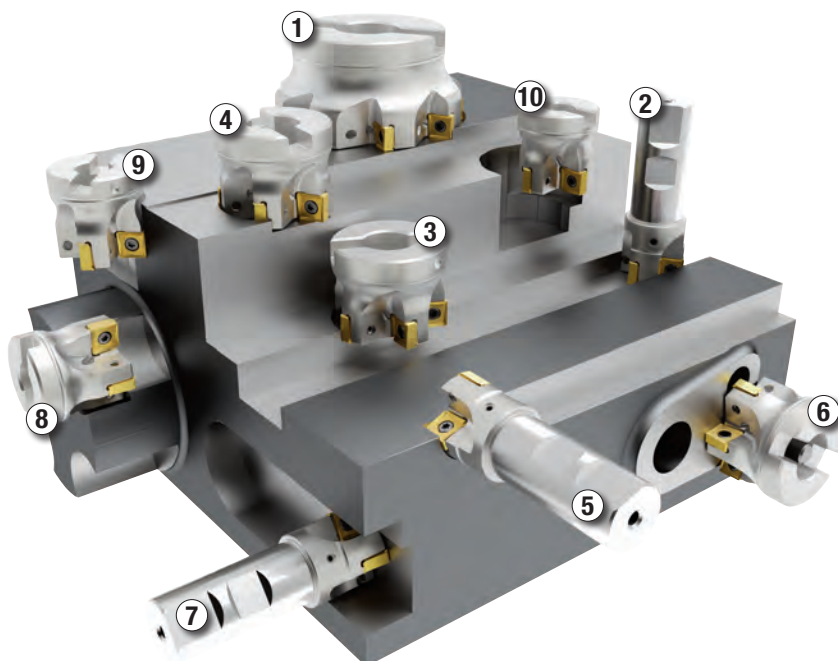



# Victory™ Shoulder-Face Mills • VSM890™-12 Series

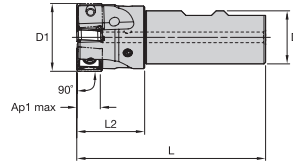

## ▼ Weldon® End Mills

order number	catalogue number	D1	D	L	L2	Ap1 max	Z	max RPM	coolant supply	kg
6596066	VSM890D032Z03B25SN12	32	25	89	32	9,8	3	33200	Yes	0,31

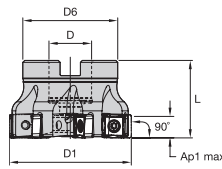

## ▼ Shell Mills

order number	catalogue number	D1	D	D6	L	Ap1 max	Z	max RPM	coolant supply	kg
6596067	VSM890D040Z04S16SN12	40	16	39	40	9,8	4	28000	Yes	0,20
6596068	VSM890D050Z04S22SN12	50	22	49	40	9,8	4	24100	Yes	0,32
6596069	VSM890D050Z05S22SN12	50	22	49	40	9,8	5	24100	Yes	0,32
6596070	VSM890D063Z05S22SN12	63	22	49	40	9,8	5	20800	Yes	0,48
6596111	VSM890D063Z07S22SN12	63	22	49	40	9,8	7	20800	Yes	0,45
6596112	VSM890D080Z05S27SN12	80	27	60	50	9,8	5	18000	Yes	0,96
6596113	VSM890D080Z07S27SN12	80	27	60	50	9,8	7	18000	Yes	1,03
6596114	VSM890D080Z09S27SN12	80	27	60	50	9,8	9	18000	Yes	1,01
6596115	VSM890D100Z06S32SN12	100	32	78	50	9,8	6	15800	Yes	1,69
6596116	VSM890D100Z08S32SN12	100	32	78	50	9,8	8	15800	Yes	1,56
6596117	VSM890D100Z11S32SN12	100	32	78	50	9,8	11	15800	Yes	1,53
6596118	VSM890D125Z07S40SN12	125	40	89	63	9,8	7	13900	Yes	2,79
6596119	VSM890D125Z10S40SN12	125	40	89	63	9,8	10	13900	Yes	2,98
6596121	VSM890D125Z14S40SN12	125	40	89	63	9,8	14	13900	Yes	2,86
6596122	VSM890D160Z08S40SN12	160	40	110	63	9,8	8	12200	Yes	4,10
6596123	VSM890D160Z12S40SN12	160	40	110	63	9,8	12	12200	Yes	4,15
6596124	VSM890D160Z16S40SN12	160	40	110	63	9,8	16	12200	Yes	8,97
6596125	VSM890D200Z10S60SN12	200	60	130	63	9,8	10	10800	Yes	5,62
6596126	VSM890D200Z14S60SN12	200	60	130	63	9,8	14	10800	Yes	5,59
6596127	VSM890D200Z22S60SN12	200	60	130	63	9,8	22	10800	Yes	5,67
6596128	VSM890D250Z16S60SN12	250	60	130	63	9,8	16	9600	Yes	8,10

## ▼ Spare Parts

D1	insert screw	Nm	wrench
32 - 250	MS-2071	4,0	DT15IP

NOTE: Please order Torx Plus driver separately.

# VSM890™ -12

Victory™ Shoulder-Face Mills • VSM890-12 Series

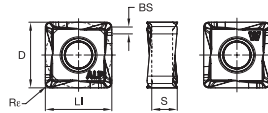

● first choice  
○ alternate choice

P	■	■	■	●	●	●	○
M	■	■	■	●	○	●	■
K	■	●	●	○	○	■	●
N	■	■	●	■	■	■	■
S	■	■	■	●	○	●	■
H	■	■	■	■	■	■	●

## ▼ SNHX-ALP • For Aluminium and Other Non-Ferrous Alloys

ISO catalogue number	cutting edges	LI	S	D	BS	Re	WK15CM	WK15PM	WN25PM	WP25PM	WP35CM	WP40PM	WS40PM	WU10PM
SNHX120408PNERALP	8	12,00	4,61	12,00	1,34	0,80	■	■	6596397	■	■	■	■	■

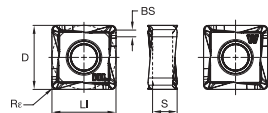

## ▼ SNHX-ML • Precision Finishing and Light Machining

ISO catalogue number	cutting edges	LI	S	D	BS	Re	WK15CM	WK15PM	WN25PM	WP25PM	WP35CM	WP40PM	WS40PM	WU10PM
SNHX120408PNERML	8	12,00	4,61	12,00	1,34	0,80	■	■	6596398	■	■	■	6596399	■

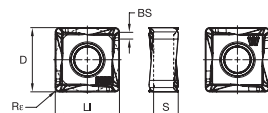

## ▼ SNHX-MM • Universal Geometry for Medium Machining

ISO catalogue number	cutting edges	LI	S	D	BS	Re	WK15CM	WK15PM	WN25PM	WP25PM	WP35CM	WP40PM	WS40PM	WU10PM
SNHX120408PNSRMM	8	12,00	4,61	12,00	1,34	0,80	■	■	6596431	■	■	6596432	6596433	6596400

## ▼ SNPX-MM • Universal Geometry for Heavy Roughing

ISO catalogue number	cutting edges	LI	S	D	BS	Re	6595550	WK15CM	WK15PM	WN25PM	WP25PM	WP35CM	WP40PM	WS40PM	WU10PM
SNPX120408PNSRMM	8	12,00	4,61	12,00	1,34	0,80	6595550	■	■	■	6595547	6595571	6595548	6595549	■



# Victory™ Shoulder-Face Mills • VSM890™-12 Series

## ▼ Insert Selection Guide

Material Group	Light Machining		General Purpose		Heavy Machining	
	Geometry	Grade	Geometry	Grade	Geometry	Grade
P1-P2	SNHX-ML	WS40PM	SNPX-MM	WP40PM	SNPX-MM	WP40PM
P3-P4	SNHX-ML	WS40PM	SNPX-MM	WP40PM	SNPX-MM	WP40PM
P5-P6	SNHX-ML	WP25PM	SNPX-MM	WP35CM	SNPX-MM	WP40PM
M1-M2	SNHX-ML	WS40PM	SNHX-ML	WS40PM	SNPX-MM	WS40PM
M3	SNHX-ML	WS40PM	SNHX-ML	WS40PM	SNPX-MM	WS40PM
K1-K2	SNPX-MM	WK15PM	SNPX-MM	WK15CM	SNPX-MM	WK15CM
K3	SNPX-MM	WK15PM	SNPX-MM	WP35CM	SNPX-MM	WP35CM
N1-N2	SNHX-ALP	WN25PM	SNHX-ALP	WN25PM	SNHX-ALP	WN25PM
N3	SNHX-ALP	WN25PM	SNHX-ALP	WN25PM	SNHX-ALP	WN25PM
S1-S2	SNHX-ML	WP25PM	SNHX-ML	WS40PM	SNPX-MM	WS40PM
S3	SNHX-ML	WS40PM	SNHX-ML	WS40PM	SNPX-MM	WS40PM
S4	SNHX-ML	WS40PM	SNHX-ML	WS40PM	SNPX-MM	WS40PM
H1	SNHX-MM	WU10PM	SNHX-MM	WU10PM	-	-

## ▼ Recommended Starting Speeds [m/min]\*

Material Group		WK15CM	WK15PM	WN25PM	WP25PM	WP35CM	WP40PM	WS40PM	WU10PM												
P	1	-	-	-	330	<b>285</b>	270	455	<b>395</b>	370	295	<b>260</b>	245	-	-	-	-	-	-		
	2	-	-	-	275	<b>240</b>	200	280	<b>255</b>	230	250	<b>215</b>	180	-	-	-	-	-	-		
	3	-	-	-	255	<b>215</b>	175	255	<b>230</b>	205	230	<b>195</b>	160	-	-	-	-	-	-		
	4	-	-	-	225	<b>185</b>	150	190	<b>175</b>	160	205	<b>170</b>	135	-	-	-	-	-	-		
	5	-	-	-	185	<b>170</b>	150	260	<b>230</b>	210	170	<b>155</b>	135	170	<b>145</b>	120	-	-	-		
M	1	-	-	-	165	<b>125</b>	100	160	<b>135</b>	110	150	<b>115</b>	90	150	<b>110</b>	80	-	-	-		
	2	-	-	-	205	<b>180</b>	165	205	<b>185</b>	155	195	<b>170</b>	155	210	<b>170</b>	140	-	-	-		
	3	-	-	-	185	<b>160</b>	130	185	<b>160</b>	140	175	<b>150</b>	125	180	<b>145</b>	120	-	-	-		
K	1	420	<b>385</b>	340	270	<b>245</b>	215	-	-	-	230	<b>205</b>	185	295	<b>265</b>	240	-	-	-		
	2	335	<b>295</b>	275	210	<b>190</b>	175	-	-	-	180	<b>160</b>	150	235	<b>210</b>	190	-	-	-		
	3	280	<b>250</b>	230	175	<b>160</b>	145	-	-	-	150	<b>135</b>	120	195	<b>175</b>	160	-	-	-		
N	1	-	-	-	-	-	-	1075	<b>945</b>	875	-	-	-	-	-	-	-	-	-		
	2	-	-	-	-	-	-	945	<b>875</b>	760	-	-	-	-	-	-	-	-	-		
	3	-	-	-	-	-	-	945	<b>875</b>	760	-	-	-	-	-	-	-	-	-		
S	1	-	-	-	-	-	-	-	-	-	40	<b>35</b>	25	-	-	-	40	<b>35</b>	25		
	2	-	-	-	-	-	-	-	-	-	40	<b>35</b>	25	-	-	-	40	<b>35</b>	25		
	3	-	-	-	-	-	-	-	-	-	50	<b>40</b>	25	-	-	-	50	<b>40</b>	25		
	4	-	-	-	-	-	-	-	-	-	70	<b>50</b>	35	-	-	-	60	<b>50</b>	30		
H	1	-	-	-	-	-	-	-	-	-	-	-	-	-	-	-	-	-	160	130	90

NOTE: FIRST choice starting speeds are in **bold** type. As the average chip thickness increases, the speed should be decreased.  
 \*Material groups P, M, K, and H show recommended starting speeds for dry machining. For wet machining, reduce speed by 20%.  
 \*Material groups N and S show recommended starting speeds for wet machining. Not recommended for dry machining.

Light Machining	General Purpose	Heavy Machining
-----------------	-----------------	-----------------

## ▼ Recommended Starting Feeds [mm]

Insert Geometry	Programmed Feed per Tooth (fz) as a % of Radial Depth of Cut (ae)															Insert Geometry
	5%			10%			20%			30%			40-100%			
.E..ALP	0,12	<b>0,28</b>	0,43	0,08	<b>0,20</b>	0,31	0,06	<b>0,15</b>	0,23	0,06	<b>0,13</b>	0,20	0,05	<b>0,12</b>	0,18	.E..ALP
.E..ML	0,17	<b>0,32</b>	0,60	0,13	<b>0,23</b>	0,44	0,09	<b>0,18</b>	0,33	0,08	<b>0,15</b>	0,28	0,08	<b>0,14</b>	0,26	.E..ML
.S..MM	0,23	<b>0,36</b>	0,82	0,17	<b>0,26</b>	0,59	0,13	<b>0,20</b>	0,44	0,11	<b>0,17</b>	0,38	0,10	<b>0,16</b>	0,35	.S..MM

NOTE: Use "Light Machining" values as starting feed rate.

# VSM890™ -12

Victory™ Shoulder-Face Mills • VSM890-12 Series

## Best Practices

True 90° roughing tool with embedded finishing capabilities all in one tool.

Best-in-class wall finish with VSM890-12 in axial stepping-down jobs. For many shop floor setups, no additional finishing is required resulting in shorter machining time and lower tooling cost.

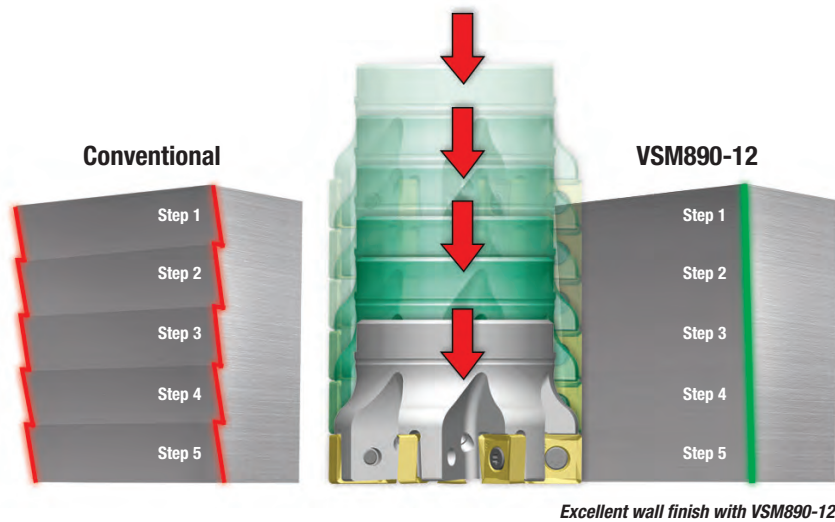

- Unstable setup.
- Low spindle power.
- High axial depth of cut  $A_{p1}$ .
- Low feed rate.
- Machining aluminium.
- Driven tools.



- Regular setup.
- Regular spindle power.
- Medium feed rate.



- Rigid setup.
- High spindle power.
- Low axial depth of cut  $A_{p1}$ .
- High feed rate.
- Boost productivity and cut into cycle time.

## Machining Stability



## Victory™ Shoulder-Face Mills • VSM890™-12 Series

### ▼ VSM890-12 Z-Axis Plunge Milling

cutting diameter (D1)	Y max	X
32	8,9	28,68
40	8,9	33,27
50	8,9	38,25
63	8,9	43,89
80	8,9	50,31
100	8,9	56,95
125	8,9	64,29
160	8,9	73,34
200	8,9	82,48
250	8,9	92,65

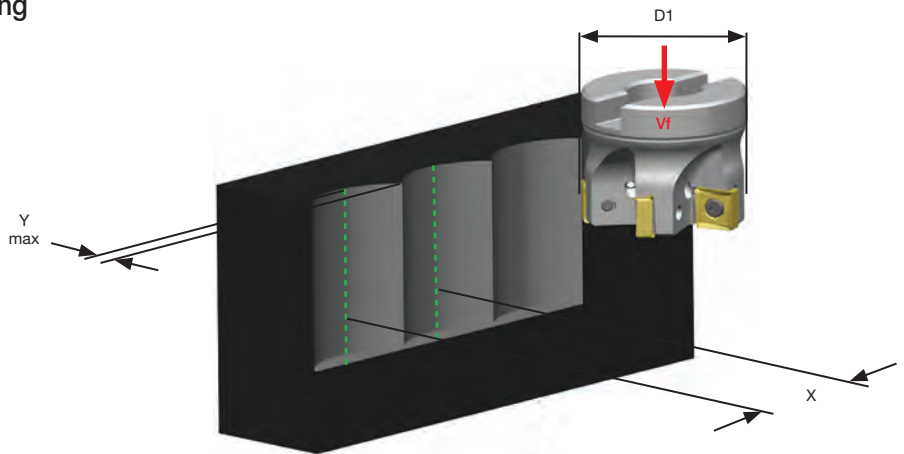

### VSM890-12 Cartridge for M4000

M4000CA-SNHX12  
(MM6602179)

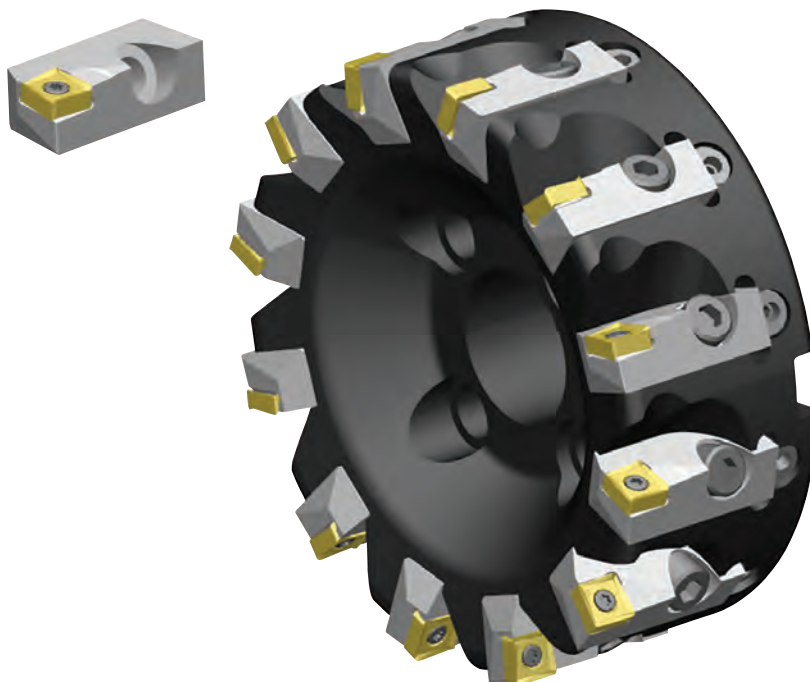



# VXF™

VICTORY™ X-FEED™



## NEXT LEVEL OF HIGH-FEED MILLING





## VXF™ -07 and VXF™ -12 Series

**VXF-07: Ap1 max: 0,9mm**  
**VXF-07: fz max: 2,0 mm/z**

**VXF-12: Ap1 max: 2,5mm**  
**VXF-12: fz max: 2,0 mm/z**

16.5° lead angle redistributes cutting forces in the spindle z-axis direction.

Feed rates up to 2,0 mm/z significantly reduce machining cycle times.

Optimised cutter body and chip gash design perfectly serves high-feed requirements.

PSTS inserts for powerful low cost per edge high-feed milling.

Cutters with internal coolant supply.

Nickel-plated surface protection.

**VXF** is a high-feed productivity booster designed to establish new industry standards with market-leading milling grades like WS40PM.

**WIDIA** 

widia.com

# VXF™ -07 and VXF™ -12

4-Edged, Victory™ X-Feed™ Mills



- 16.5° lead angle redistributes cutting forces in the spindle z-axis direction.
- Greatly reduces tool deflection and vibrations for improved tool life.
- Suitable for long tool reach.
- Unique integrated radial wiping facet to achieve a nice wall finish at pocket and helical interpolation milling.
- Durable cutting edges qualified to machine a wide range of materials.
- WS40PM — best-in-class milling grade for machining stainless steel and HTA.

Perfect combination of round and square insert style.

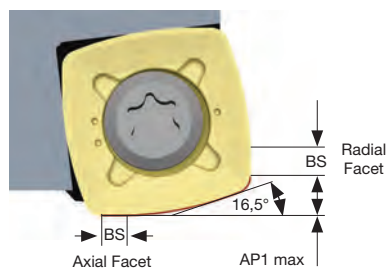

## Specifically engineered chipbreakers for powerful high-feed milling.

-MM  
VXF-07

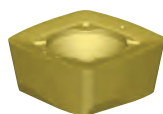

**P M S**

First choice for Soft Steel, Stainless Steel, and High-Temp Alloys. Best fit for pocketing and profiling operations.

-MM  
VXF-12

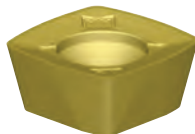

**P M S**

First choice for Soft Steel, Stainless Steel, and High-Temp Alloys. Best fit for pocketing and profiling operations.

-MH  
VXF-07

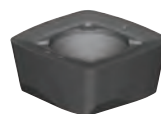

**P H**

First choice for P3 and P4 materials. Stronger edge protection for heavy roughing jobs and hardened steel up to 48HRc.

-MH  
VXF-12

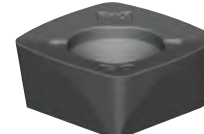

**P**

First choice for P3 and P4 materials. Stronger edge protection for heavy roughing jobs.

Lower Cutting Forces

Geometry Strengthening/Stronger Cutting Edge Protection

## Applications

1. Face milling.
2. 3D profile milling.
3. Pocket milling into full material.
4. Helical interpolation into full material.
5. Deep pocket milling into full material.
6. Dynamic/trochoidal milling.
7. Aggressive ramp milling.
8. Contour Milling.
9. Face milling deep cavities with long tool reach.
10. Z-axis contour plunge milling.

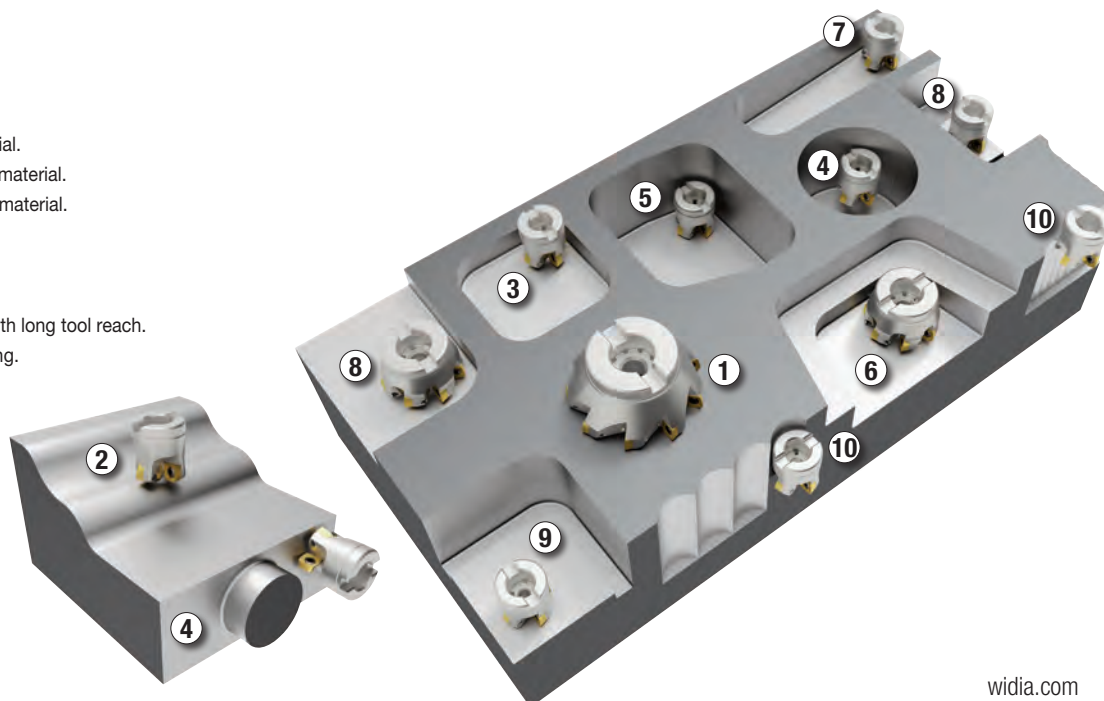



# Victory™ High-Feed Mills • VXF™-07 Series

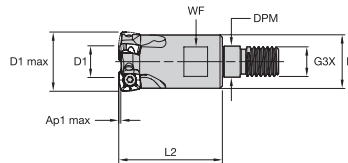

## ▼ Screw-On End Mills

order number	catalogue number	D1 max	D1	D	DPM	G3X	L2	WF	Ap1 max	Z	max ramp angle	max RPM	coolant supply	kg
6597130	VXF016Z02M08XP07	16	7	13	8,5	M8	25	11	0,9	2	5.9°	65000	Yes	0,03
6597151	VXF020Z03M10XP07	20	11	18	10,5	M10	35	15	0,9	3	3.4°	57000	Yes	0,07
6597152	VXF025Z04M12XP07	25	16	21	12,5	M12	35	18	0,9	4	2.2°	49000	Yes	0,09
6597153	VXF032Z05M16XP07	32	23	29	17,0	M16	43	24	0,9	5	1.4°	41500	Yes	0,22

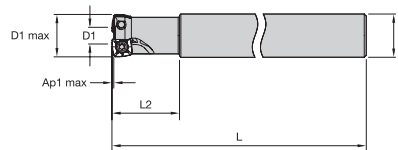

## ▼ Cylindrical End Mills

order number	catalogue number	D1 max	D1	D	L	L2	Ap1 max	Z	max ramp angle	max RPM	coolant supply	kg
6597154	VXF016Z02A16XP07L180	16	7	16	180	25	0,9	2	5.9°	65000	Yes	0,24
6597155	VXF018Z02A18XP07L180	18	9	18	180	25	0,9	2	5.4°	61000	Yes	0,31
6597156	VXF020Z03A20XP07L190	20	11	20	190	32	0,9	3	3.4°	57000	Yes	0,41
6597157	VXF025Z04A25XP07L200	25	16	25	200	40	0,9	4	2.2°	49000	Yes	0,69

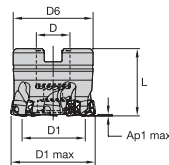

## ▼ Shell Mills

order number	catalogue number	D1 max	D1	D	D6	L	Ap1 max	Z	max ramp angle	max RPM	coolant supply	kg
6597158	VXF040Z05S16XP07	40	31	16	38	32	0,9	5	1.0°	35000	Yes	0,19
6597159	VXF050Z07S22XP07	50	41	22	42	40	0,9	7	.7°	31300	Yes	0,33

## ▼ Spare Parts

D1 max	insert screw	Nm	wrench
16 - 50	12148067200	1,7	12148086600

NOTE: Please order wrench separately.

# VXF™ -07

Victory™ High-Feed Mills • VXF-07 Series

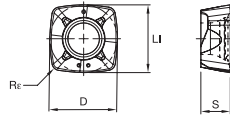

● first choice  
○ alternate choice

P	●	●	○
M	●	●	●
K	○	○	●
N	○	○	○
S	●	○	○
H	○	○	●

## ▼ XPPT-MM • Best Fit for Pocketing and Profiling Operations

ISO catalogue number	cutting edges	LI	S	D	Re	WP25PM	WP40PM	WS40PM	WU10PM
XPPT070308ERMM	4	7,30	3,17	7,30	0,80	6595619	I	6595620	I

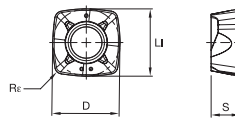

## ▼ XPPW-MH • Dedicated Geometry for Heavy Roughing

ISO catalogue number	cutting edges	LI	S	D	Re	WP25PM	WP40PM	WS40PM	WU10PM
XPPW070310SRMH	4	7,30	3,17	7,30	1,00	I	6595770	I	6595769

## ▼ Insert Selection Guide

Material Group	Light Machining		General Purpose		Heavy Machining	
	Geometry	Grade	Geometry	Grade	Geometry	Grade
P1-P2	XPPT-MM	WP25PM	XPPT-MM	WS40PM	XPPW-MH	WP40PM
P3-P4	XPPT-MM	WP25PM	XPPT-MM	WS40PM	XPPW-MH	WP40PM
P5-P6	XPPT-MM	WP25PM	XPPT-MM	WS40PM	XPPW-MH	WP40PM
M1-M2	XPPT-MM	WS40PM	XPPT-MM	WS40PM	XPPW-MH	WP40PM
M3	XPPT-MM	WS40PM	XPPT-MM	WS40PM	XPPW-MH	WP40PM
K1-K2	XPPW-MH	WU10PM	XPPW-MH	WU10PM	XPPW-MH	WU10PM
K3	XPPW-MH	WU10PM	XPPW-MH	WU10PM	XPPW-MH	WU10PM
S1-S2	XPPT-MM	WP25PM	XPPT-MM	WS40PM	-	-
S3	XPPT-MM	WS40PM	XPPT-MM	WS40PM	-	-
S4	XPPT-MM	WS40PM	XPPT-MM	WS40PM	-	-
H1	XPPW-MH	WU10PM	XPPW-MH	WU10PM	-	-

## Victory™ High-Feed Mills • VXF™-07 Series

### ▼ Recommended Starting Speeds [m/min]\*

Material Group		WP25PM			WP40PM			WS40PM			WU10PM		
P	1	395	<b>340</b>	325	355	<b>310</b>	295	-	-	-	-	-	-
	2	330	<b>290</b>	240	300	<b>260</b>	215	-	-	-	-	-	-
	3	305	<b>260</b>	210	275	<b>235</b>	190	-	-	-	-	-	-
	4	270	<b>220</b>	180	245	<b>205</b>	160	-	-	-	-	-	-
	5	220	<b>205</b>	180	205	<b>185</b>	160	205	<b>175</b>	145	-	-	-
	6	200	<b>150</b>	120	180	<b>140</b>	110	180	<b>130</b>	95	-	-	-
M	1	245	<b>215</b>	200	235	<b>205</b>	185	250	<b>205</b>	170	-	-	-
	2	220	<b>190</b>	155	210	<b>180</b>	150	215	<b>175</b>	145	-	-	-
	3	170	<b>145</b>	115	155	<b>140</b>	110	175	<b>130</b>	100	-	-	-
K	1	275	<b>245</b>	220	-	-	-	-	-	-	355	320	290
	2	215	<b>190</b>	180	-	-	-	-	-	-	275	245	230
	3	180	<b>160</b>	145	-	-	-	-	-	-	235	210	190
S	1	50	<b>40</b>	30	50	<b>40</b>	35	50	<b>40</b>	30	-	-	-
	2	50	<b>40</b>	30	50	<b>40</b>	35	50	<b>40</b>	30	-	-	-
	3	60	<b>50</b>	30	60	<b>50</b>	35	60	<b>50</b>	30	-	-	-
	4	85	<b>60</b>	40	80	<b>60</b>	40	70	<b>60</b>	35	-	-	-
H	1	145	<b>110</b>	85	-	-	-	-	-	-	190	155	110

NOTE: FIRST choice starting speeds are in **bold** type. As the average chip thickness increases, the speed should be decreased.  
 \*Material groups P, M, K, and H show recommended starting speeds for dry machining. For wet machining, reduce speed by 20%.  
 \*Material groups N and S show recommended starting speeds for wet machining. Not recommended for dry machining.

### ▼ Recommended Starting Feeds [mm]

Light Machining	General Purpose	Heavy Machining
-----------------	-----------------	-----------------

At 0,60 Axial Depth of Cut (AP1)

Insert Geometry	Recommended Starting Feed per Tooth (Fz) in Relation to % of Radial Engagement (ae)															Insert Geometry
	5%			10%			20%			30%			40-100%			
.E..MM	0,46	<b>1,32</b>	2,43	0,32	<b>0,89</b>	1,53	0,24	<b>0,65</b>	1,09	0,21	<b>0,56</b>	0,94	0,19	<b>0,52</b>	0,85	.E..MM
.S..MH	0,84	<b>1,84</b>	3,12	0,59	<b>1,21</b>	1,85	0,43	<b>0,87</b>	1,30	0,38	<b>0,75</b>	1,12	0,34	<b>0,69</b>	1,02	.S..MH

At 0,70 Axial Depth of Cut (AP1)

Insert Geometry	Recommended Starting Feed per Tooth (Fz) in Relation to % of Radial Engagement (ae)															Insert Geometry
	5%			10%			20%			30%			40-100%			
.E..MM	0,42	<b>1,21</b>	2,20	0,30	<b>0,83</b>	1,41	0,22	<b>0,60</b>	1,01	0,19	<b>0,52</b>	0,87	0,18	<b>0,48</b>	0,79	.E..MM
.S..MH	0,78	<b>1,68</b>	2,79	0,55	<b>1,12</b>	1,71	0,40	<b>0,81</b>	1,21	0,35	<b>0,70</b>	1,04	0,32	<b>0,64</b>	0,94	.S..MH

At 0,90 Axial Depth of Cut (AP1)

Insert Geometry	Recommended Starting Feed per Tooth (Fz) in Relation to % of Radial Engagement (ae)															Insert Geometry
	5%			10%			20%			30%			40-100%			
.E..MM	0,37	<b>1,06</b>	1,89	0,27	<b>0,73</b>	1,24	0,20	<b>0,53</b>	0,89	0,17	<b>0,46</b>	0,77	0,16	<b>0,42</b>	0,70	.E..MM
.S..MH	0,68	<b>1,46</b>	2,35	0,48	<b>0,98</b>	1,49	0,36	<b>0,71</b>	1,07	0,31	<b>0,62</b>	0,92	0,28	<b>0,56</b>	0,84	.S..MH

NOTE: Use "Light Machining" values as starting feed rate.

### ▼ CAM Programming

Programming Data			
insert size	insert radius	R (to be programmed)	t
07	0,8	1,4	0,4
	1,0	1,5	0,4

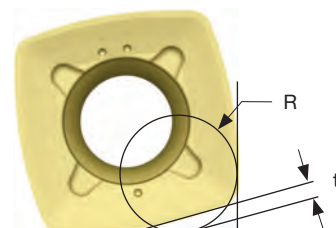



# VXF™ -12

Victory™ High-Feed Mills • VXF-12 Series

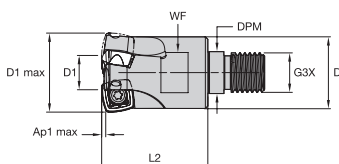

## ▼ Screw-On End Mills

order number	catalogue number	D1 max	D1	D	DPM	G3X	L2	WF	Ap1 max	Z	max ramp angle	max RPM	coolant supply	kg
6596723	VXF032Z03M16XD12	32	14	29	17,0	M16	43	24	2,5	3	1.8°	31500	Yes	0,19

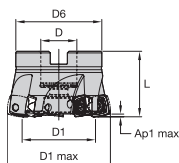

## ▼ Shell Mills

order number	catalogue number	D1 max	D1	D	D6	L	Ap1 max	Z	max ramp angle	max RPM	coolant supply	kg
6596725	VXF040Z04S22XD12	40	22	22	38	40	2,5	4	1.4°	26500	Yes	0,18
6596727	VXF042Z04S22XD12	42	24	22	38	40	2,5	4	1.3°	25500	Yes	0,20
6596728	VXF050Z04S22XD12	50	32	22	48	40	2,5	4	.9°	22500	Yes	0,31
6596729	VXF052Z05S22XD12	52	34	22	48	40	2,5	5	.8°	22000	Yes	0,32
6596730	VXF063Z05S22XD12	63	45	22	53	40	2,5	5	.6°	19500	Yes	0,47
6596732	VXF066Z06S27XD12	66	48	27	53	45	2,5	6	.5°	19000	Yes	0,56
6596733	VXF080Z06S27XD12	80	62	27	55	50	2,5	6	.5°	17000	Yes	0,89
6596734	VXF100Z07S32XD12	100	82	32	65	50	2,5	7	.3°	15000	Yes	1,38

## ▼ Spare Parts

D1 max	insert screw	Nm	wrench
32 - 100	12148007200	3,8	12148099400

NOTE: Please order wrench separately.

Victory™ High-Feed Mills • VXF™-12 Series

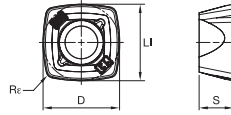

● first choice  
○ alternate choice

P	●	●	○
M	●	●	●
K	○	○	○
N	○	○	○
S	●	○	●
H	○	○	○

▼ XDPT-MM • Best Fit for Pocketing and Profiling Operations

ISO catalogue number	cutting edges	LI	S	D	R <sub>ε</sub>	WP25PM	WP40PM	WS40PM
XDPT120512ERMM	4	12,70	5,56	12,70	1,20	6596438	I	6596439

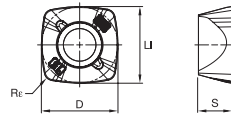

▼ XDPT-MH • Dedicated Geometry for Heavy Roughing

ISO catalogue number	cutting edges	LI	S	D	R <sub>ε</sub>	WP25PM	WP40PM	WS40PM
XDPT120515SRMH	4	12,70	5,56	12,70	1,50	I	6596440	I

▼ Insert Selection Guide

Material Group	Light Machining		General Purpose		Heavy Machining	
	Geometry	Grade	Geometry	Grade	Geometry	Grade
P1-P2	XDPT-MM	WP25PM	XDPT-MM	WS40PM	XDPT-MH	WP40PM
P3-P4	XDPT-MM	WP25PM	XDPT-MM	WS40PM	XDPT-MH	WP40PM
P5-P6	XDPT-MM	WP25PM	XDPT-MM	WS40PM	XDPT-MH	WP40PM
M1-M2	XDPT-MM	WS40PM	XDPT-MM	WS40PM	XDPT-MH	WP40PM
M3	XDPT-MM	WS40PM	XDPT-MM	WS40PM	XDPT-MH	WP40PM
S1-S2	XDPT-MM	WP25PM	XDPT-MM	WS40PM	XDPT-MH	WP40PM
S3	XDPT-MM	WS40PM	XDPT-MM	WS40PM	XDPT-MH	WP40PM
S4	XDPT-MM	WS40PM	XDPT-MM	WS40PM	XDPT-MH	WP40PM

# VXF™ -12

Victory™ High-Feed Mills • VXF-12 Series

## ▼ Recommended Starting Speeds [m/min]\*

Material Group		WP25PM			WP40PM			WS40PM		
P	1	395	<b>340</b>	325	355	<b>310</b>	295	-	-	-
	2	330	<b>290</b>	240	300	<b>260</b>	215	-	-	-
	3	305	<b>260</b>	210	275	<b>235</b>	190	-	-	-
	4	270	<b>220</b>	180	245	<b>205</b>	160	-	-	-
	5	220	<b>205</b>	180	205	<b>185</b>	160	205	<b>175</b>	145
	6	200	<b>150</b>	120	180	<b>140</b>	110	180	<b>130</b>	95
M	1	245	<b>215</b>	200	235	<b>205</b>	185	250	<b>205</b>	170
	2	220	<b>190</b>	155	210	<b>180</b>	150	215	<b>175</b>	145
	3	170	<b>145</b>	115	155	<b>140</b>	110	175	<b>130</b>	100
S	1	50	<b>40</b>	30	50	<b>40</b>	35	50	<b>40</b>	30
	2	50	<b>40</b>	30	50	<b>40</b>	35	50	<b>40</b>	30
	3	60	<b>50</b>	30	60	<b>50</b>	35	60	<b>50</b>	30
	4	85	<b>60</b>	40	80	<b>60</b>	40	70	<b>60</b>	35

NOTE: FIRST choice starting speeds are in **bold** type. As the average chip thickness increases, the speed should be decreased.

\*Material groups P, M, K, and H show recommended starting speeds for dry machining. For wet machining, reduce speed by 20%.

\*Material groups N and S show recommended starting speeds for wet machining. Not recommended for dry machining.

## ▼ Recommended Starting Feeds [mm]

Light Machining	General Purpose	Heavy Machining
-----------------	-----------------	-----------------

### At 1,30 Axial Depth of Cut (AP1)

Insert Geometry	Recommended Starting Feed per Tooth (Fz) in Relation to % of Radial Engagement (ae)															Insert Geometry
	5%			10%			20%			30%			40-100%			
.E..MM	0,49	<b>1,59</b>	2,52	0,35	<b>1,13</b>	1,78	0,26	<b>0,84</b>	1,31	0,23	<b>0,73</b>	1,14	0,21	<b>0,67</b>	1,04	.E..MM
.S..MH	0,70	<b>1,80</b>	2,76	0,51	<b>1,28</b>	1,94	0,38	<b>0,95</b>	1,44	0,33	<b>0,83</b>	1,25	0,30	<b>0,76</b>	1,14	.S..MH

### At 1,70 Axial Depth of Cut (AP1)

Insert Geometry	Recommended Starting Feed per Tooth (Fz) in Relation to % of Radial Engagement (ae)															Insert Geometry
	5%			10%			20%			30%			40-100%			
.E..MM	0,43	<b>1,39</b>	2,20	0,31	<b>0,99</b>	1,56	0,23	<b>0,74</b>	1,15	0,20	<b>0,64</b>	1,00	0,19	<b>0,59</b>	0,92	.E..MM
.S..MH	0,62	<b>1,57</b>	2,41	0,45	<b>1,12</b>	1,70	0,33	<b>0,84</b>	1,26	0,29	<b>0,73</b>	1,10	0,27	<b>0,67</b>	1,00	.S..MH

### At 2,50 Axial Depth of Cut (AP1)

Insert Geometry	Recommended Starting Feed per Tooth (Fz) in Relation to % of Radial Engagement (ae)															Insert Geometry
	5%			10%			20%			30%			40-100%			
.E..MM	0,36	<b>1,15</b>	1,81	0,26	<b>0,83</b>	1,29	0,19	<b>0,62</b>	0,96	0,17	<b>0,54</b>	0,83	0,15	<b>0,49</b>	0,76	.E..MM
.S..MH	0,51	<b>1,30</b>	1,99	0,37	<b>0,93</b>	1,41	0,28	<b>0,70</b>	1,05	0,24	<b>0,61</b>	0,91	0,22	<b>0,55</b>	0,83	.S..MH

NOTE: Use "Light Machining" values as starting feed rate.

## ▼ CAM Programming

Programming Data			
insert size	insert radius	R (to be programmed)	t
12	1,2	2,7	0,97
	1,5	2,8	0,95

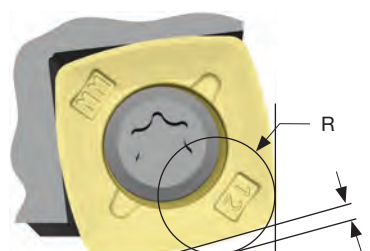



# Victory™ High-Feed Mills • VXF-07™ and VXF™-12 Series

## Best Practices

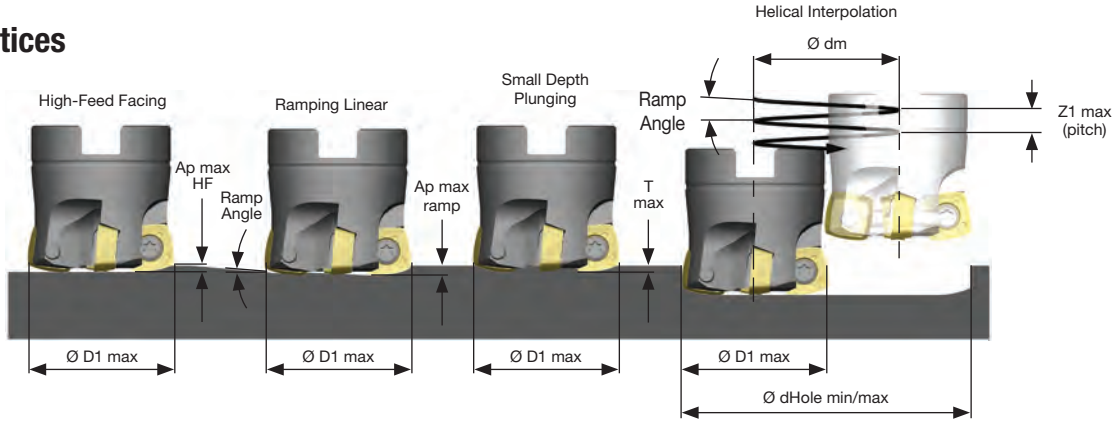

	D1 max	High-Feed Facing	Ramping Linear		Helical Interpolation			Small Depth Plunging	
		Ap max HF	Ramp Angle max	Ap max Ramp	Ramp Angle max	d Hole min	d Hole max	Z1 max Helical	T max
VXF-07	16	0,60	5,9	0,60	5,9	22,0	30,0	0,60	0,45
	18	0,60	5,4	0,60	5,4	24,0	32,0	0,60	0,45
	20	0,60	3,4	0,60	3,4	30,0	38,0	0,60	0,30
	25	0,60	2,2	0,60	2,2	40,0	48,0	0,60	0,30
	32	0,60	1,4	0,60	1,4	54,0	62,0	0,60	0,30
VXF-12	40	0,60	1,0	0,60	1,0	70,0	78,0	0,60	0,30
	50	0,60	0,7	0,60	0,7	90,0	98,0	0,60	0,30
	32	1,30	1,8	1,80	1,8	42,0	62,0	1,80	0,80
	40	1,30	1,4	1,80	1,4	58,0	78,0	1,80	0,80
	42	1,30	1,3	1,80	1,3	62,0	82,0	1,80	0,80
	50	1,30	0,9	1,80	0,9	78,0	98,0	1,80	0,80
	52	1,30	0,8	1,80	0,8	82,0	102,0	1,80	0,80
	63	1,30	0,6	1,80	0,6	104,0	124,0	1,80	0,80
	66	1,30	0,5	1,80	0,5	110,0	130,0	1,80	0,80
	80	1,30	0,5	1,80	0,5	138,0	158,0	1,80	0,80
100	1,30	0,3	1,80	0,3	178,0	198,0	1,80	0,80	

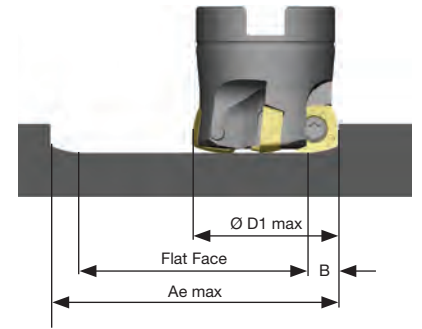

	D1 max	B
VXF-07	16-50	4,20
VXF-12	32-100	9,10

$\text{Ø}dm = \text{Ø}Hole - \text{Ø}D1 \text{ max}$

$Z1 = \text{Ø}dm \times 3,14 \times \tan \text{ramp angle}$ .  $Z1 \leq Z1 \text{ max}$  and  $\leq \text{ramp angle max}$

$\text{Ramp angle} = \arcsin \left( \frac{Z1}{\text{Ø}dm \times 3,14} \right)$

$Ae \text{ max} \leq 2 \times \text{Ø}D1 \text{ max} - 2 \times B$

$\text{Flat Face} = Ae \text{ max} - 2 \times B$

## Z-Axis Plunge Milling

VXF-07			VXF-12		
cutting diameter (D1)	Y max	X	cutting diameter (D1)	Y max	X
16	3,0	12,49	32	9,0	28,77
18	3,0	13,41	40	9,0	33,40
20	3,0	14,28	42	9,0	34,46
25	3,0	16,24	50	9,0	38,41
32	3,0	18,65	52	9,0	39,34
40	3,0	21,07	63	9,0	44,09
50	3,0	23,74	66	9,0	45,29
			80	9,0	50,55
			100	9,0	57,23

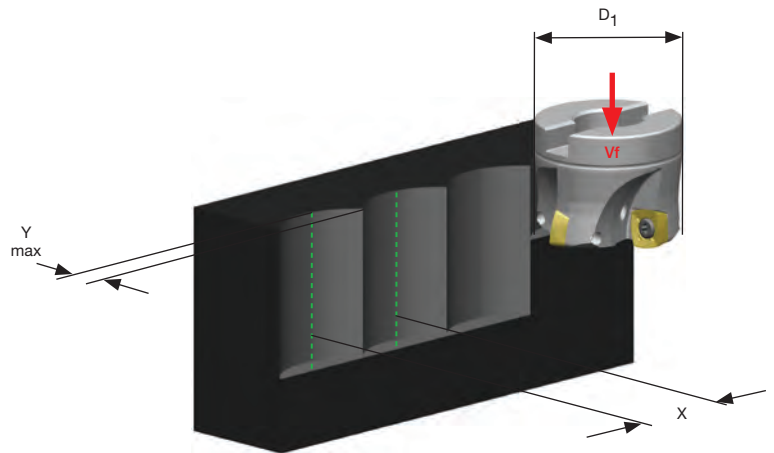

## Feed Rate Guide • Z-Axis Plunge Milling • fz (mm/tooth)

Light Machining	General Purpose	Heavy Machining
-----------------	-----------------	-----------------

	Insert Geometry	Recommended Starting Feed per Tooth (Fz)			Insert Geometry	Y max
		Light Machining	General Purpose	Heavy Machining		
VXF-07	.E.MM	0,06	0,15	-	.E.MM	3,0
	.S.MH	0,10	0,20	-	.S.MH	3,0
VXF-12	.E.MM	0,07	0,20	0,30	.E.MM	9,0
	.S.MH	0,10	0,25	0,35	.S.MH	9,0

# WIDIA-HANITA™

## A SOLID FOUNDATION THE VARIMILL™ FAMILY

The WIDIA-Hanita VariMill family continues to provide leading-edge solutions for some of the most advanced applications in the general engineering, aerospace, and defense industries. These industries require complex machining techniques in some of the most exotic materials.

### VariMill I™

This 4-flute geometry is designed with unequal flute spacing for plunging, slotting, and profiling at the highest possible feed rates for a wide range of materials.





## VariMill II™

This 5-flute geometry is designed with unequal flute spacing for advanced milling jobs in a wide range of materials.



## VariMill III™

This 7-flute geometry is designed with unequal flute spacing and is designed to provide the highest Metal Removal Rates (MRR) and extended tool life in the most demanding materials in the aerospace industry.

**COMING SOON!**

See the entire VariMill™ platform in the 2019 VariMill Family Catalogue coming soon!

**WIDIA™ HANITA** 

[widia.com](http://widia.com)



# 70NS

VICTORY™ X-FEED™



PRODUCTIVITY IMPROVED IN  
HIGH-FEED MILLING OF STAINLESS  
STEEL AND TITANIUM MATERIALS

**NEW!**



## 70NS Series

Designed for high-feed rates.

6 flutes and 3 x D diameter neck reach.

Designed for circular plunging and ramping, 3D machining, face milling, and pocketing applications.

Stainless steel and high-temp alloys.

Improved tool life due to reduced radial forces.

Larger radial engagement vs. standard ball nose end mills.



**5–10%**  
Radial engagement



**55%**  
Radial engagement

**WIDIA** 

widia.com



### ▼ 70NS Series • X-Feed

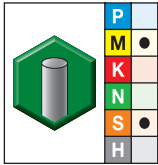

grade AlTiN-MT  
AlTiN

- first choice
- alternate choice

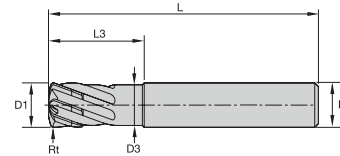
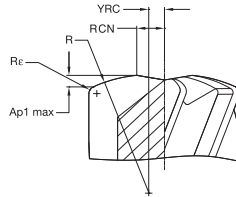

order #	catalogue #	D1	D	D3	L3	length L	Re	Rt
6441882	70NS06002	6,0	6	5,50	17,75	63	0,38	0,67
6441883	70NS08003	8,0	8	7,50	23,75	76	0,50	0,89
6441884	70NS10004	10,0	10	9,00	29,50	89	0,63	1,12
6441885	70NS12005	12,0	12	11,00	35,50	100	0,75	1,34
6441886	70NS16006	16,0	16	15,00	47,50	110	1,00	1,79
6441887	70NS20007	20,0	20	19,00	59,50	125	1,25	2,23
6441888	70NS25008	25,0	25	23,50	74,25	150	1,56	2,90

NOTE: YRC = distance from centre line to the crown of the R radius.  
 RCN = distance from centre line to the start of the cutting edge. This dimension can also help determine the minimum circle size when helical ramping.  
 R = the head radius size.  
 Re = the shoulder radius or radius at the corner of the cutter.



#### End Mill Tolerances

D1	tolerance e8	D	tolerance h6 + / -
≤ 3	-0,014/-0,028	≤ 3	0/0,006
> 3-6	-0,020/-0,038	> 3-6	0/0,008
> 6-10	-0,025/-0,047	> 6-10	0/0,009
> 10-18	-0,032/-0,059	> 10-18	0/0,011
> 18-30	-0,040/-0,073	> 18-30	0/0,013

### ▼ Programming Data

70NS Metric																
Geometrical Parameters									Ramping Guide for Circular and Linear Interpolation							
									Circular Interpolation				Linear Interpolation			
									Allowed Range of Hole Diameter				Calculated Length (mm) per Ramp Angle			
													Ramp Angle (degree)			
diameter	Ap1 max	Rfm	Rt	Rc	Xfm	Yfm	YD	Number	Smallest	Largest	1	2	3	4	5	
[mm]	[mm]	[mm]	[mm]	[mm]	[mm]	[mm]	[mm]	flutes								
6	0,32	6	0,67	0,375	0,338	0,75	1,26	6	8,52	12	18,12	9,06	6,03	4,52	3,61	
8	0,42	8	0,89	0,500	0,450	1,00	1,68	6	11,36	16	24,16	12,08	8,05	6,03	4,82	
10	0,53	10	1,12	0,625	0,562	1,25	2,10	6	14,2	20	30,20	15,09	10,06	7,54	6,02	
12	0,63	12	1,34	0,750	0,674	1,50	2,52	6	17,04	24	36,24	18,11	12,07	9,05	7,23	
16	0,84	16	1,79	1,000	0,915	2,00	3,36	6	22,72	32	48,31	24,15	16,09	12,06	9,64	
20	1,05	20	2,23	1,250	1,124	2,50	4,20	6	28,4	40	60,39	30,19	20,11	15,08	12,05	
25	1,25	25	2,90	1,5625	1,405	3,1250	5,25	6	35,5	50	70,61	35,80	23,85	17,88	14,29	
Recommended Feed											30%	30%	30%	30%	10%	

## ▼ 70NS Series • X-Feed

Material Group														
	Profile Milling		AlTiN-MT			Recommended Feed Per Tooth (fz = mm/th) for 3D milling/profiling (A)								
	A		Cutting Speed – Vc m/min			D1 – Diameter								
	ap	ae	min		max	mm	6,0	8,0	10,0	12,0	16,0	20,0	25,0	
M	1	0.5 x D	0.55 x D	90	–	115	fz	0,300	0,400	0,500	0,540	0,720	0,900	1,125
	2	0.5 x D	0.55 x D	60	–	80	fz	0,240	0,320	0,400	0,480	0,640	0,800	1,000
	3	0.5 x D	0.55 x D	60	–	70	fz	0,240	0,320	0,400	0,480	0,640	0,800	1,000
S	1	0.5 x D	0.55 x D	50	–	90	fz	0,270	0,360	0,450	0,500	0,650	0,800	1,000
	2	0.5 x D	0.55 x D	50	–	80	fz	0,240	0,320	0,400	0,480	0,600	0,700	0,900
	3	0.5 x D	0.55 x D	25	–	40	fz	0,180	0,240	0,300	0,350	0,430	0,500	0,600
	4	0.5 x D	0.55 x D	50	–	60	fz	0,210	0,280	0,350	0,420	0,560	0,700	0,875

NOTE: Lower value of cutting speed is used for high stock removal applications or for higher hardness (machinability) within group.

Higher value of cutting speed is used for finishing applications or for lower hardness (machinability) within group.

Above parameters are based on ideal conditions. For smaller taper machining centres, please adjust parameters accordingly on diameters greater than 12mm.



# 4U50 & 4U80



AEROSPACE ROUGHING

**NEW!**



## 4U50

Shallow pitch rougher.

4–6 flutes with variable spacing.

Short length of cut and 3 x D diameter neck length.

Stainless steel and high-temp alloys.

Centre cutting.



## 4U80

Shallow pitch rougher.

4–6 flutes with variable spacing.

Regular length of cut.

Stainless steel and high-temp alloys.

Centre cutting.

**WIDIA** 

widia.com

# High-Performance Roughers

4U50 Series

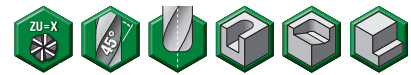

## ▼ 4U50 Series

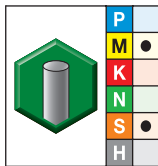

grade AITiN-MT  
AITiN

- first choice
- alternate choice

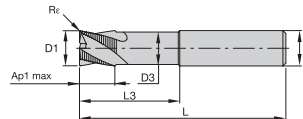

order #	catalogue #	D1	D	D3	length of cut Ap1 max	L3	length L	Re	ZU
6431403	4U50M060R2TC	6,0	6	5,64	6,00	18,00	57	0,30	4
6431404	4U50M080R3TC	8,0	8	7,52	8,00	24,00	63	0,30	4
6431405	4U50M100R4TE	10,0	10	9,40	10,00	30,00	72	0,50	4
6431406	4U50M120R5TE	12,0	12	11,28	12,00	36,00	83	0,50	4
6431407	4U50M160R6TE	16,0	16	15,04	16,00	48,00	92	0,50	6
6431408	4U50M200R7TG	20,0	20	18,80	20,00	60,00	104	1,00	6
6431409	4U50M250R8TG	25,0	25	23,50	25,00	75,00	121	1,00	6

### End Mill Tolerances

D1	tolerance d11	D	tolerance h6 + / -
≤ 3	-0,020/-0,080	≤ 3	0/-0,006
> 3-6	-0,030/-0,105	> 3-6	0/-0,008
> 6-10	-0,040/-0,130	> 6-10	0/-0,009
> 10-18	-0,050/-0,160	> 10-18	0/-0,011
> 18-30	-0,065/-0,195	> 18-30	0/-0,013

## ▼ 4U50 Series

Material Group	Side Milling (A) and Slotting (B)		AITiN-MT		Recommended feed per tooth (fz = mm/th) for side milling (A). For slotting (B), reduce fz by 20%.												
	A		B		Cutting Speed – Vc m/min		D1 – Diameter										
	ap	ae	ap		min	max	6,0	8,0	10,0	12,0	14,0	16,0	18,0	20,0	25,0		
							mm										
M	1	0,8 x D	0,5 x D	0,75 x D	90	–	115	fz	0,036	0,050	0,061	0,070	0,079	0,087	0,095	0,101	0,114
	2	0,8 x D	0,4 x D	0,75 x D	60	–	80	fz	0,029	0,040	0,048	0,056	0,063	0,070	0,076	0,081	0,091
	3	0,8 x D	0,4 x D	0,75 x D	60	–	70	fz	0,025	0,034	0,040	0,047	0,052	0,057	0,061	0,065	0,071
S	1	0,8 x D	0,4 x D	0,75 x D	50	–	90	fz	0,036	0,050	0,061	0,070	0,079	0,087	0,095	0,101	0,114
	2	0,8 x D	0,25 x D	0,3 x D	25	–	40	fz	0,019	0,026	0,032	0,037	0,042	0,046	0,050	0,054	0,061
	3	0,8 x D	0,4 x D	0,75 x D	60	–	80	fz	0,029	0,040	0,048	0,056	0,063	0,070	0,076	0,081	0,091
	4	0,8 x D	0,3 x D	0,3 x D	50	–	60	fz	0,026	0,037	0,045	0,052	0,058	0,064	0,069	0,074	0,084

NOTE: Lower value of cutting speed is used for high stock removal applications or for higher hardness (machinability) within group.  
Higher value of cutting speed is used for finishing applications or for lower hardness (machinability) within group.  
Above parameters are based on ideal conditions. For smaller taper machining centres, please adjust parameters accordingly on diameters greater than 12mm.

# 4U80 Series



## ▼ 4U80 Series

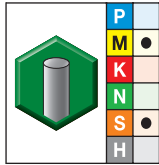

grade AlTiN-MT  
AlTiN

- first choice
- alternate choice

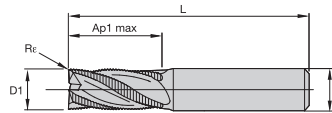

order #	catalogue #	D1	D	length of cut Ap1 max	length L	Re	ZU
6431246	4U80M060R2TC	6,0	6	13,00	57	0,30	4
6431247	4U80M080R3TC	8,0	8	16,00	63	0,30	4
6431248	4U80M100R4TE	10,0	10	22,00	72	0,50	4
6431249	4U80M120R5TE	12,0	12	26,00	83	0,50	4
6431250	4U80M160R6TE	16,0	16	32,00	92	0,50	6
6431401	4U80M200R7TG	20,0	20	38,00	104	1,00	6
6431402	4U80M250R8TG	25,0	25	45,00	121	1,00	6

### End Mill Tolerances

D1	tolerance d11	D	tolerance h6 + / -
≤ 3	-0,020/-0,080	≤ 3	0/-0,006
> 3-6	-0,030/-0,105	> 3-6	0/-0,008
> 6-10	-0,040/-0,130	> 6-10	0/-0,009
> 10-18	-0,050/-0,160	> 10-18	0/-0,011
> 18-30	-0,065/-0,195	> 18-30	0/-0,013

## ▼ 4U80 Series

Material Group	Side Milling (A) and Slotting (B)		AITiN-MT		Recommended feed per tooth (fz = mm/th) for side milling (A). For slotting (B), reduce fz by 20%.															
	A		B		Cutting Speed – Vc m/min			D1 – Diameter												
	ap	ae	ap		min	max	mm	6,0	8,0	10,0	12,0	14,0	16,0	18,0	20,0	25,0				
M	1	1 x D	0,5 x D	0,75 x D	90	–	115	fz	0,036	0,050	0,061	0,070	0,079	0,087	0,095	0,101	0,114			
	2	1 x D	0,5 x D	0,75 x D	60	–	80	fz	0,029	0,040	0,048	0,056	0,063	0,070	0,076	0,081	0,091			
	3	1 x D	0,5 x D	0,75 x D	60	–	70	fz	0,025	0,034	0,040	0,047	0,052	0,057	0,061	0,065	0,071			
S	1	1 x D	0,3 x D	0,75 x D	50	–	90	fz	0,036	0,050	0,061	0,070	0,079	0,087	0,095	0,101	0,114			
	2	1 x D	0,3 x D	0,3 x D	25	–	40	fz	0,019	0,026	0,032	0,037	0,042	0,046	0,050	0,054	0,061			
	3	1 x D	0,4 x D	0,75 x D	60	–	80	fz	0,029	0,040	0,048	0,056	0,063	0,070	0,076	0,081	0,091			
	4	1 x D	0,4 x D	0,75 x D	50	–	60	fz	0,026	0,037	0,045	0,052	0,058	0,064	0,069	0,074	0,084			

NOTE: Lower value of cutting speed is used for high stock removal applications or for higher hardness (machinability) within group.  
Higher value of cutting speed is used for finishing applications or for lower hardness (machinability) within group.  
Above parameters are based on ideal conditions. For smaller taper machining centres, please adjust parameters accordingly on diameters greater than 12mm.



# GP

4-FLUTE RADIUS END MILLS



THE EVOLUTION OF A SOLID  
CARBIDE END MILL REVOLUTION

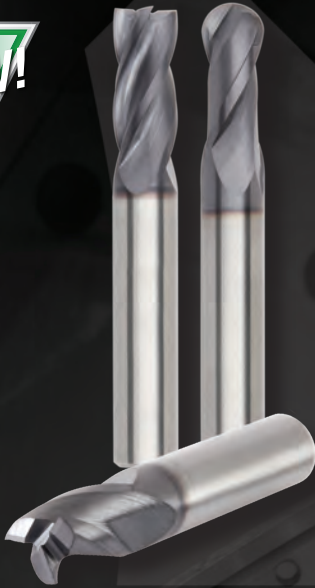

## GP 4-Flute Radius End Mills

WIDIA-Hanita general purpose end mills offer plunging, slotting, and profiling for a wide range of materials and applications. Designed to provide high metal removal rates and excellent surface conditions at a value price. A wide range of diameters, lengths, and corner styles (such as chamfered, sharp edge, and ball nose) are available from stock.

### Radius Series — 4004/4014/4024

- Centre cutting.
- Steel, stainless steel, and cast iron.
- Radius corner for extended tool life.
- Regular, long, and extra long length of cut.

The WIDIA-Hanita™ solid carbide end mill product lines have built a strong ongoing reputation of continuous development and diversification.

**WIDIA™ HANITA™** 

**WIDIA™** 

[widia.com](http://widia.com)



### ▼ 4004 4014 4024 Series • VariMill GP Radius

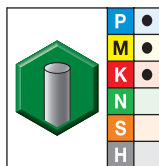

grade TiAlN  
TiAlN

- first choice
- alternate choice

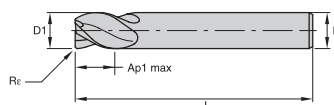

order #	D1	D	length of cut Ap1 max	length L	Re
6337590	2,0	3	6,30	38	0,50
6337731	3,0	3	9,50	38	0,50
6337892	3,0	3	19,00	63	0,50
6338335	3,0	3	25,00	75	0,50
6337732	3,0	3	9,50	38	1,00
6337733	4,0	4	11,00	50	0,50
6337893	4,0	4	19,00	63	0,50
6338336	4,0	4	31,00	75	0,50
6337734	4,0	4	11,00	50	1,00
6337894	4,0	4	19,00	63	1,00
6338337	4,0	4	31,00	75	1,00
6337735	5,0	5	13,00	50	0,50
6337895	5,0	5	30,00	75	0,50
6337896	5,0	5	30,00	75	1,00
6337736	6,0	6	16,00	50	0,50
6337897	6,0	6	28,00	75	0,50
6338338	6,0	6	38,00	100	0,50
6337737	6,0	6	16,00	50	1,00
6337898	6,0	6	28,00	75	1,00
6338339	6,0	6	38,00	100	1,00
6337738	8,0	8	20,00	50	0,50
6337899	8,0	8	28,00	75	0,50
6338340	8,0	8	41,00	100	0,50
6337739	8,0	8	20,00	50	1,00
6337900	8,0	8	28,00	75	1,00
6338341	8,0	8	41,00	100	1,00
6337740	10,0	10	22,00	72	0,50
6337911	10,0	10	32,00	89	0,50
6338342	10,0	10	45,00	100	0,50
6337741	10,0	10	22,00	72	1,00
6337912	10,0	10	32,00	89	1,00
6338343	10,0	10	45,00	100	1,00
6337742	12,0	12	25,00	89	0,50
6337913	12,0	12	45,00	100	0,50
6338344	12,0	12	75,00	150	0,50
6337743	12,0	12	25,00	89	1,00
6337914	12,0	12	45,00	100	1,00
6338345	12,0	12	75,00	150	1,00
6337744	16,0	16	32,00	92	0,50
6337915	16,0	16	56,00	110	0,50

(continued)

# 4004 4014 4024 Series

(4004 4014 4024 Series • VariMill™ GP Radius — continued)

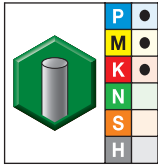

● first choice  
○ alternate choice

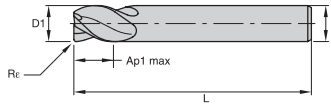

grade TiAlN  
TiAlN

order #	D1	D	length of cut Ap1 max	length L	Re
6338346	16,0	16	75,00	150	0,50
6337745	16,0	16	32,00	92	1,00
6337916	16,0	16	56,00	110	1,00
6338347	16,0	16	75,00	150	1,00
6338349	20,0	20	75,00	150	0,50

NOTE: Refer to NOVO™ for the complete GP end mill offering.

### End Mill Tolerances

D1	tolerance e8	D	tolerance h6 + / -
≤ 3	-0,014/-0,028	≤ 3	0/0,006
> 3-6	-0,020/-0,038	> 3-6	0/0,008
> 6-10	-0,025/-0,047	> 6-10	0/0,009
> 10-18	-0,032/-0,059	> 10-18	0/0,011
> 18-30	-0,040/-0,073	> 18-30	0/0,013

### ▼ 4004 4014 4024 Series • VariMill GP Radius

Material Group																						
	Side Milling (A) and Slotting (B)		TiAlN		Recommended feed per tooth (fz = mm/th) for side milling (A). For slotting (B), reduce fz by 20%.																	
	A		B		Cutting Speed – Vc m/min		D1 – Diameter															
	ap	ae	ap	min	max	mm	1,0	2,0	3,0	4,0	5,0	6,0	8,0	10,0	12,0	14,0	16,0	18,0	20,0			
P	0	Ap1 max	0,1 x D	0,5 x D	150	– 200	fz	0,007	0,014	0,021	0,028	0,036	0,044	0,060	0,072	0,083	0,092	0,101	0,108	0,114		
	1	Ap1 max	0,1 x D	0,5 x D	150	– 200	fz	0,007	0,014	0,021	0,028	0,036	0,044	0,060	0,072	0,083	0,092	0,101	0,108	0,114		
	2	Ap1 max	0,1 x D	0,5 x D	140	– 190	fz	0,007	0,014	0,021	0,028	0,036	0,044	0,060	0,072	0,083	0,092	0,101	0,108	0,114		
	3	Ap1 max	0,1 x D	0,5 x D	120	– 160	fz	0,006	0,011	0,017	0,023	0,030	0,036	0,050	0,061	0,070	0,079	0,087	0,095	0,101		
M	1	Ap1 max	0,1 x D	0,5 x D	90	– 150	fz	0,005	0,010	0,016	0,021	0,027	0,033	0,045	0,054	0,062	0,070	0,077	0,083	0,088		
	2	Ap1 max	0,1 x D	0,5 x D	90	– 115	fz	0,006	0,011	0,017	0,023	0,030	0,036	0,050	0,061	0,070	0,079	0,087	0,095	0,101		
K	1	Ap1 max	0,1 x D	0,5 x D	60	– 80	fz	0,005	0,009	0,014	0,019	0,024	0,029	0,040	0,048	0,056	0,063	0,070	0,076	0,081		
	2	Ap1 max	0,1 x D	0,5 x D	120	– 150	fz	0,007	0,014	0,021	0,028	0,036	0,044	0,060	0,072	0,083	0,092	0,101	0,108	0,114		
K	1	Ap1 max	0,1 x D	0,5 x D	110	– 140	fz	0,006	0,011	0,017	0,023	0,030	0,036	0,050	0,061	0,070	0,079	0,087	0,095	0,101		
	2	Ap1 max	0,1 x D	0,5 x D	110	– 140	fz	0,006	0,011	0,017	0,023	0,030	0,036	0,050	0,061	0,070	0,079	0,087	0,095	0,101		

NOTE: Lower value of cutting speed is used for high stock removal applications or for higher hardness (machinability) within group.  
Higher value of cutting speed is used for finishing applications or for lower hardness (machinability) within group.  
Above parameters are based on ideal conditions. For smaller taper machining centres, please adjust parameters accordingly on greater than 12mm diameters.



# TDMX

TOP DRILL™ MODULAR X



STABILITY AND RELIABILITY  
COMBINED INTO ONE MODULAR  
DRILL SYSTEM





## Platform

Standard cutter bodies in 3 x D, 5 x D, and 8 x D lengths.

Insert diameter range from 16mm up to 40mm.

One geometry and grade to cover steel and cast iron applications.

## Easy to Apply

Front clamping design. No need to disassemble the body from the holder to change insert.

Easy insert nomenclature logic to identify the targeted material group.

## Increased Stability and Performance

Highly engineered pocket seat design to ensure maximum stability, even in challenging applications like cross hole, inclined entry/exit, and interrupted cuts.

Suitable for high feed rates.

Flanged shank for higher rigidity.

Polished flutes for improved chip evacuation.

Brand new WP40PD grade for longer tool life in steel and cast iron applications.

**WIDIA™ TOP DRILL™ Modular X (TDMX)** is the ultimate choice for high-demanding drilling applications when stability and reliability are required.

**WIDIA** 

widia.com

# TDMX — TOP DRILL™ Modular X

Extra-Stable Modular Drill up to 40mm Diameter

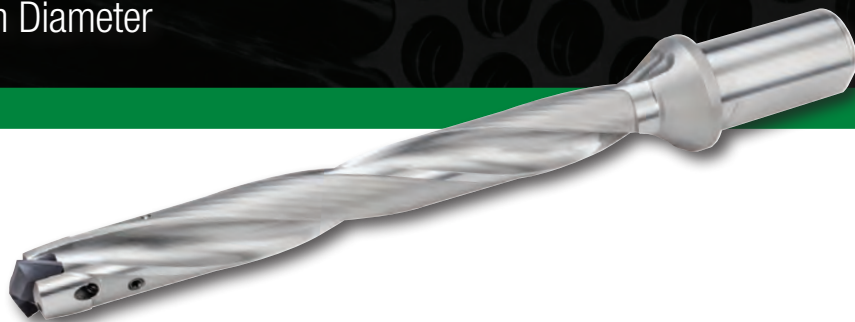

- Augmented insert stability thanks to the highly engineered pocket seat design.
- Front clamping for an easy insert change, without disassembling the holder from the machine spindle.
- Diameter range from 16mm up to 40mm.
- L/D ratio of 3 x D, 5 x D, and 8 x D.

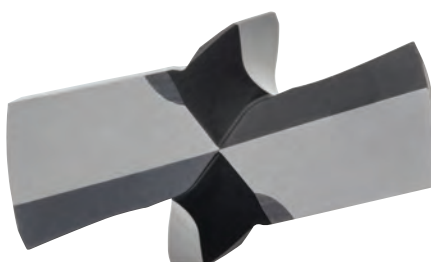

One geometry to cover two material groups in modular drilling.

PK



First choice for Steel and Cast Iron drilling.

## TDMX — Tube Sheet Drilling

**P** Steel

Material: Fe510/1.0553/A441  
Condition: rough surface

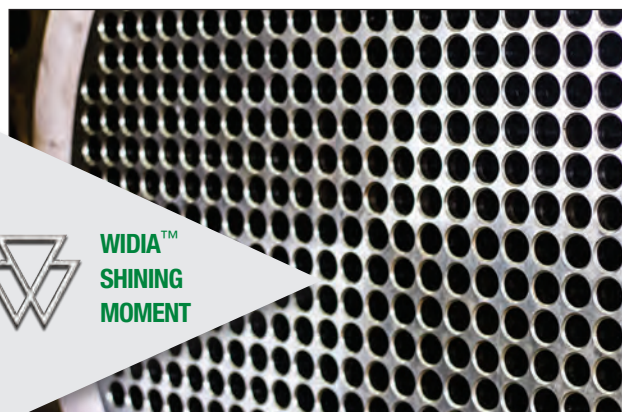

Specifications	Competitor	WIDIA
Diameter (mm)	25,6	25,6
Grade	—	WP40PD
Geometry	—	PK
Vc (m/min)	100	100
n (rev/min)	1,247	1,247
f (mm/rev)	0,33	0,35
Vf (mm/min)	400	437
LOC (mm)	50	50
Coolant	Internal Emulsion	Internal Emulsion
Tool Life (m)	30	48



## Modular Drill System • TDMX

### ▼ TDMX Body – Technical Details

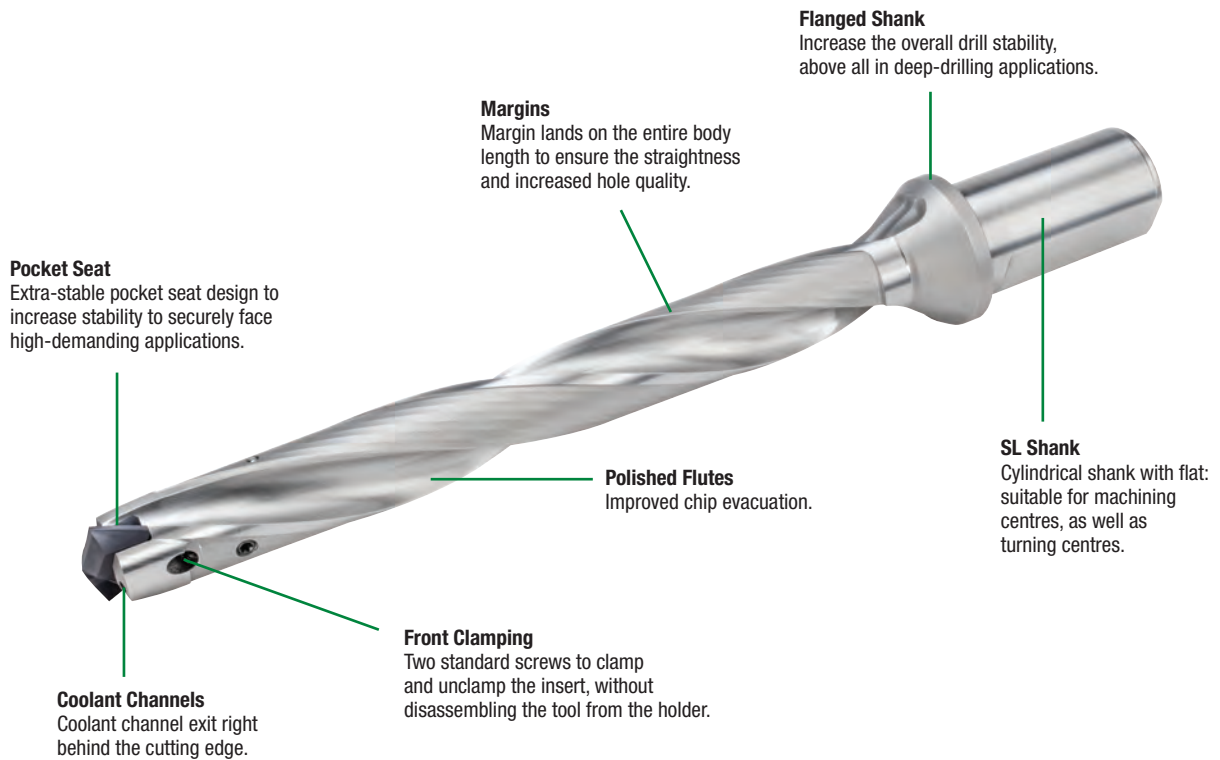

### ▼ TDMX Pocket Seat – Technical Details

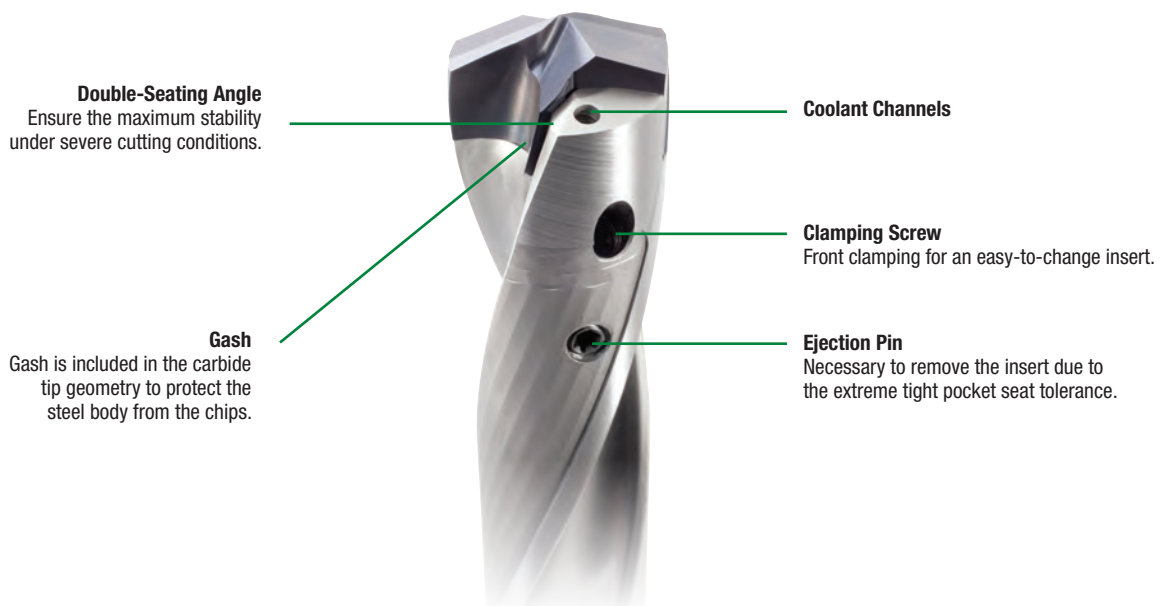



# TDMX — TOP DRILL™ Modular X

Modular Drill System • TDMX

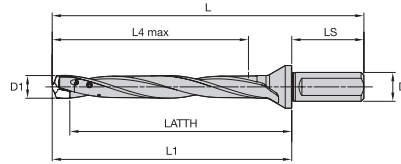

## ▼ TOP DRILL™ Modular X • 3 x D / 5 x D / 8 x D • Side Lock Shank • Metric



3 x D		5 x D		8 x D		SSC	D1		clamping screw	wrench
order #	catalogue #	order #	catalogue #	order #	catalogue #		min	max		
6572091	TDMX160R3SL20M	6572125	TDMX160R5SL20M	6572155	TDMX160R8SL20M	A	16,000	16,999	193.537	12148086600
6572092	TDMX170R3SL20M	6572126	TDMX170R5SL20M	6572156	TDMX170R8SL20M	B	17,000	17,999	193.537	12148086600
6572093	TDMX180R3SL25M	6572127	TDMX180R5SL25M	6572157	TDMX180R8SL25M	C	18,000	18,999	193.537	12148086600
6572094	TDMX190R3SL25M	6572128	TDMX190R5SL25M	6572158	TDMX190R8SL25M	D	19,000	19,999	193.537	12148086600
6572096	TDMX200R3SL25M	6572129	TDMX200R5SL25M	6572159	TDMX200R8SL25M	E	20,000	20,999	193.523	170.0240
6572097	TDMX210R3SL25M	6572130	TDMX210R5SL25M	6572160	TDMX210R8SL25M	F	21,000	21,999	193.523	170.0240
6572098	TDMX220R3SL25M	6572141	TDMX220R5SL25M	6572171	TDMX220R8SL25M	G	22,000	22,999	193.523	170.0240
6572099	TDMX230R3SL25M	6572142	TDMX230R5SL25M	6572172	TDMX230R8SL25M	H	23,000	23,999	193.523	170.0240
6572100	TDMX240R3SL32M	6572143	TDMX240R5SL32M	6572173	TDMX240R8SL32M	I	24,000	24,999	193.524	12148082400
6572101	TDMX250R3SL32M	6572144	TDMX250R5SL32M	6572174	TDMX250R8SL32M	J	25,000	25,999	193.524	12148082400
6572102	TDMX260R3SL32M	6572145	TDMX260R5SL32M	6572175	TDMX260R8SL32M	K	26,000	26,999	193.524	12148082400
6572104	TDMX270R3SL32M	6572146	TDMX270R5SL32M	6572176	TDMX270R8SL32M	L	27,000	27,999	193.524	12148082400
6572105	TDMX280R3SL32M	6572147	TDMX280R5SL32M	6572177	TDMX280R8SL32M	M	28,000	28,999	193.525	TT15
6572106	TDMX290R3SL32M	6572148	TDMX290R5SL32M	6572178	TDMX290R8SL32M	N	29,000	29,999	193.525	TT15
6572107	TDMX300R3SL32M	6572149	TDMX300R5SL32M	6572179	TDMX300R8SL32M	O	30,000	30,999	193.525	TT15
6572108	TDMX310R3SL32M	6572150	TDMX310R5SL32M	6572180	TDMX310R8SL32M	P	31,000	31,999	193.525	TT15
6572109	TDMX320R3SL40M	6572151	TDMX320R5SL40M	6572181	TDMX320R8SL40M	Q	32,000	33,999	193.525	TT15
6572110	TDMX340R3SL40M	6572152	TDMX340R5SL40M	6572182	TDMX340R8SL40M	R	34,000	35,999	193.525	TT15
6572121	TDMX360R3SL40M	6572153	TDMX360R5SL40M	6572183	TDMX360R8SL40M	S	36,000	37,999	193.585	TT15
6572122	TDMX380R3SL40M	6572154	TDMX380R5SL40M	6572184	TDMX380R8SL40M	T	38,000	40,000	193.585	TT15

NOTE: SSC = Pocket Seat Reference. To correspond with the SSC on the inserts.

## ▼ Dimensions

SSC	mm			SHORT ~3 x D				LONG ~5 x D				EXTRA LONG ~8 x D				
	D1 min	D1 max	LS	D	LATTH	L	L1	L4 max	LATTH	L	L1	L4 max	LATTH	L	L1	L4 max
A	16,000	16,999	50	20	68,8	131	81	51	102,8	165	115	85	153,8	216	166	136
B	17,000	17,999	50	20	73,8	136	86	54	109,8	172	122	90	163,8	226	176	144
C	18,000	18,999	56	25	76,7	146	90	57	114,7	184	128	95	171,7	241	185	152
D	19,000	19,999	56	25	81,7	151	95	60	121,7	191	135	100	181,7	251	195	160
E	20,000	20,999	56	25	84,6	155	99	63	126,6	197	141	105	189,6	260	204	168
F	21,000	21,999	56	25	89,6	160	104	66	133,6	204	148	110	199,6	270	214	176
G	22,000	22,999	56	25	92,5	164	108	69	138,5	210	154	115	207,5	279	223	184
H	23,000	23,999	56	25	97,5	169	113	72	145,5	217	161	120	217,5	289	233	192
I	24,000	24,999	60	32	100,4	177	117	75	150,4	227	167	125	225,4	302	242	200
J	25,000	25,999	60	32	105,4	182	122	78	157,4	234	174	130	235,4	312	252	208
K	26,000	26,999	60	32	108,3	186	126	81	162,3	240	180	135	243,3	321	261	216
L	27,000	27,999	60	32	113,3	191	131	84	169,3	247	187	140	253,3	331	271	224
M	28,000	28,999	60	32	116,2	195	135	87	174,2	253	193	145	261,2	340	280	232
N	29,000	29,999	60	32	121,2	200	140	90	181,2	260	200	150	271,2	350	290	240
O	30,000	30,999	60	32	124,1	204	144	93	186,1	266	206	155	279,1	359	299	248
P	31,000	31,999	60	32	129,1	209	149	96	193,1	273	213	160	289,1	369	309	256
Q	32,000	33,999	70	40	136,0	228	158	102	204,0	296	226	170	306,0	398	328	272
R	34,000	35,999	70	40	145,0	237	167	108	217,0	309	239	180	325,0	417	347	288
S	36,000	37,999	70	40	151,8	246	176	114	227,8	322	252	190	341,8	436	366	304
T	38,000	40,000	70	40	160,8	255	185	120	240,8	335	265	200	360,8	455	385	320

# Modular Drill System • TDMX

## ▼ TOP DRILL™ Modular X • PK(M)



● first choice  
○ alternate choice

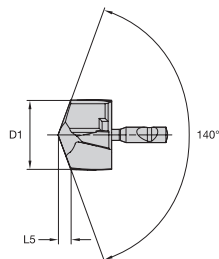

grade WP40PD  
TiAIN

order #	catalogue #	D1	L5	SSC
6568446	TDMX16000PKM	16,00	3,21	A
6568447	TDMX16200PKM	16,20	3,25	A
6568448	TDMX16281PKM	16,28	3,26	A
6568449	TDMX16500PKM	16,50	3,30	A
6568450	TDMX16667PKM	16,67	3,33	A
6568461	TDMX17000PKM	17,00	3,39	B
6568462	TDMX17064PKM	17,06	3,41	B
6568464	TDMX17463PKM	17,46	3,48	B
6568465	TDMX17500PKM	17,50	3,49	B
6568467	TDMX17600PKM	17,60	3,50	B
6568471	TDMX17800PKM	17,80	3,54	B
6568472	TDMX17859PKM	17,86	3,55	B
6568473	TDMX18000PKM	18,00	3,58	C
6568474	TDMX18255PKM	18,26	3,64	C
6568475	TDMX18500PKM	18,50	3,68	C
6568476	TDMX18651PKM	18,65	3,71	C
6568477	TDMX18800PKM	18,80	3,74	C
6568478	TDMX19000PKM	19,00	3,78	D
6568479	TDMX19050PKM	19,05	3,78	D
6568480	TDMX19200PKM	19,20	3,81	D
6568481	TDMX19270PKM	19,27	3,82	D
6568482	TDMX19450PKM	19,45	3,86	D
6568483	TDMX19500PKM	19,50	3,87	D
6568484	TDMX19700PKM	19,70	3,90	D
6568485	TDMX19840PKM	19,84	3,93	D
6568813	TDMX20000PKM	20,00	3,97	E
6568814	TDMX20100PKM	20,10	3,99	E
6568815	TDMX20200PKM	20,20	4,01	E
6568816	TDMX20239PKM	20,24	4,02	E
6568817	TDMX20300PKM	20,30	4,03	E
6568818	TDMX20400PKM	20,40	4,05	E
6568819	TDMX20500PKM	20,50	4,06	E
6568820	TDMX20600PKM	20,60	4,08	E
6568841	TDMX20650PKM	20,65	4,09	E
6568842	TDMX20700PKM	20,70	4,10	E
6568843	TDMX20800PKM	20,80	4,12	E
6568844	TDMX20900PKM	20,90	4,14	E
6568845	TDMX21000PKM	21,00	4,16	F
6568846	TDMX21430PKM	21,43	4,23	F
6568847	TDMX21500PKM	21,50	4,25	F
6568848	TDMX22000PKM	22,00	4,35	G
6568849	TDMX22225PKM	22,23	4,39	G
6568850	TDMX22450PKM	22,45	4,44	G
6568851	TDMX22500PKM	22,50	4,44	G
6568852	TDMX23000PKM	23,00	4,54	H
6568853	TDMX23500PKM	23,50	4,63	H
6568854	TDMX23813PKM	23,81	4,68	H
6568856	TDMX24000PKM	24,00	4,73	I
6568857	TDMX24500PKM	24,50	4,82	I
6568858	TDMX24605PKM	24,61	4,84	I
6568859	TDMX25000PKM	25,00	4,91	J
6568860	TDMX25400PKM	25,40	4,99	J
6568861	TDMX25500PKM	25,50	5,01	J
6568862	TDMX25670PKM	25,67	5,04	J
6568863	TDMX25700PKM	25,70	5,04	J
6568864	TDMX25760PKM	25,76	5,05	J

(continued)

# TDMX — TOP DRILL™ Modular X

Modular Drill System • TDMX

(TOP DRILL Modular X • PK(M) — continued)

P	●
M	○
K	●
N	○
S	○
H	○

● first choice  
○ alternate choice

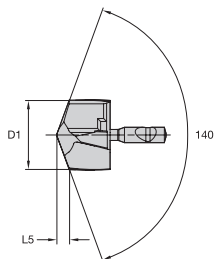

grade WP40PD  
TiAlN



order #	catalogue #	D1	L5	SSC
6568865	TDMX25796PKM	25,80	5,06	J
6568866	TDMX26000PKM	26,00	5,11	K
6568867	TDMX26192PKM	26,19	5,15	K
6568868	TDMX26400PKM	26,40	5,18	K
6568869	TDMX26500PKM	26,50	5,20	K
6568870	TDMX26589PKM	26,59	5,22	K
6568871	TDMX27000PKM	27,00	5,29	L
6568872	TDMX27500PKM	27,50	5,38	L
6568873	TDMX27780PKM	27,78	5,43	L
6568874	TDMX28000PKM	28,00	5,49	M
6568875	TDMX28176PKM	28,18	5,52	M
6568876	TDMX28500PKM	28,50	5,58	M
6568877	TDMX28575PKM	28,58	5,59	M
6568878	TDMX29000PKM	29,00	5,67	N
6568879	TDMX29367PKM	29,37	5,74	N
6568880	TDMX29500PKM	29,50	5,76	N
6568891	TDMX29764PKM	29,76	5,81	N
6568892	TDMX30000PKM	30,00	5,87	O
6568893	TDMX30163PKM	30,16	5,90	O
6568896	TDMX30500PKM	30,50	5,96	O
6568897	TDMX30955PKM	30,96	6,04	O
6568898	TDMX31000PKM	31,00	6,05	P
6568899	TDMX31500PKM	31,50	6,14	P
6568900	TDMX31750PKM	31,75	6,18	P
6568901	TDMX32000PKM	32,00	6,25	Q
6568902	TDMX32500PKM	32,50	6,34	Q
6568903	TDMX33000PKM	33,00	6,43	Q
6568904	TDMX33338PKM	33,34	6,49	Q
6568905	TDMX34000PKM	34,00	6,61	R
6568906	TDMX34130PKM	34,13	6,64	R
6568907	TDMX34925PKM	34,93	6,78	R
6568908	TDMX35000PKM	35,00	6,79	R
6568909	TDMX35500PKM	35,50	6,89	R
6568910	TDMX36000PKM	36,00	7,00	S
6568911	TDMX36500PKM	36,50	7,09	S
6568912	TDMX37000PKM	37,00	7,18	S
6568913	TDMX37500PKM	37,50	7,27	S
6568914	TDMX38000PKM	38,00	7,36	T
6568915	TDMX38100PKM	38,10	7,38	T
6568916	TDMX38500PKM	38,50	7,46	T
6568917	TDMX39000PKM	39,00	7,55	T
6568918	TDMX39289PKM	39,29	7,60	T
6568919	TDMX39500PKM	39,50	7,64	T
6568920	TDMX40000PKM	40,00	7,73	T

NOTE: SSC = Pocket Seat Reference. To correspond with the SSC on the toolholder.

Metric  
tolerance

D1	tolerance k8
8–10	0,000/+0,022
>10–17	0,000/+0,027
>17–18	0,000/+0,027
>18–21	0,000/+0,033

## ▼ TOP DRILL Modular X • PK(M) • WP40PD • Speed and Feed Chart • Metric

Material Group										
	Cutting Speed – Vc Range – m/min			Recommended Feed Rate (f) by Diameter						
	min	Starting Value	max	Tool Diameter (mm)	16,0	20,0	25,0	32,0	40,0	
<b>P</b>	1	90	125	170	mm/r	0,19–0,45	0,25–0,48	0,25–0,52	0,28–0,57	0,29–0,60
	2	105	140	180	mm/r	0,23–0,46	0,28–0,50	0,30–0,52	0,33–0,57	0,35–0,60
	3	50	75	100	mm/r	0,23–0,46	0,28–0,50	0,30–0,52	0,33–0,57	0,35–0,60
	4	50	75	100	mm/r	0,19–0,45	0,22–0,48	0,25–0,50	0,28–0,55	0,29–0,58
	5	50	65	80	mm/r	0,16–0,32	0,18–0,36	0,22–0,42	0,24–0,46	0,25–0,48
	6	50	65	80	mm/r	0,16–0,32	0,18–0,36	0,22–0,42	0,24–0,46	0,25–0,48
<b>M</b>	1	40	80	110	mm/r	0,11–0,26	0,13–0,28	0,13–0,32	0,14–0,35	0,15–0,37
	2	35	55	75	mm/r	0,11–0,26	0,13–0,28	0,13–0,32	0,14–0,35	0,15–0,37
	3	20	35	50	mm/r	0,11–0,26	0,13–0,28	0,13–0,32	0,14–0,35	0,15–0,37
<b>K</b>	1	60	95	170	mm/r	0,25–0,48	0,28–0,52	0,32–0,56	0,35–0,62	0,37–0,65
	2	60	75	90	mm/r	0,25–0,48	0,28–0,52	0,32–0,56	0,35–0,62	0,37–0,65
	3	40	65	90	mm/r	0,21–0,44	0,23–0,48	0,25–0,50	0,28–0,55	0,29–0,58

NOTE: Through coolant recommended for greater than 3 x D applications.  
Material group M is recommended for secondary applications.



# TDMX — TOP DRILL™ Modular X

Modular Drill System • TDMX

## Assembling and Disassembling Instructions

### ▼ Assembly

#### 1 Insert positioning

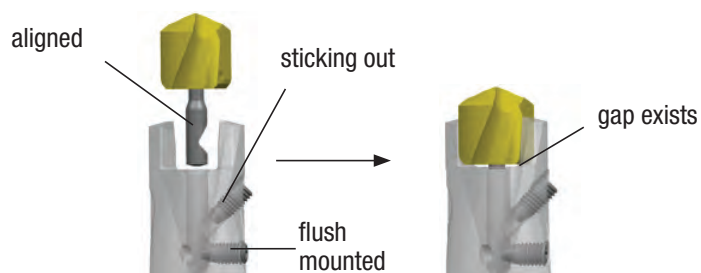

#### 2 Insert clamping

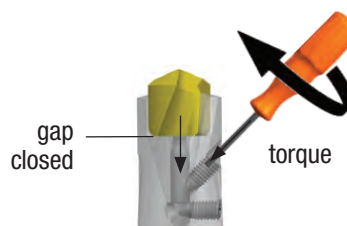

Drill diameter	Torque
ø 16–19,999mm	1,5 Nm
ø 20–23,999mm	2,1 Nm
ø 24–27,999mm	3,0 Nm
ø 28–40,000mm	4,5 Nm

### ▼ Disassembly

#### 1 Clamping screw loosening



#### 2 Insert pushing out

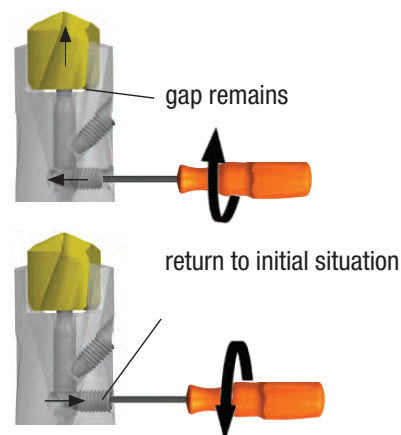

#### 3 Further clamping screw loosening

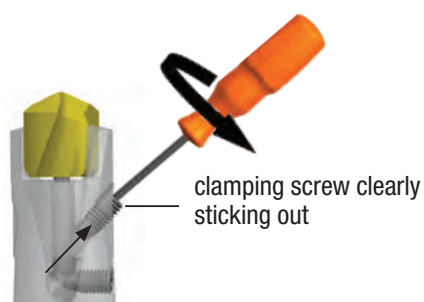

#### 4 Insert removal



## TDMX Application Notes • Power and Coolant Requirements

### Drive Power (kW)

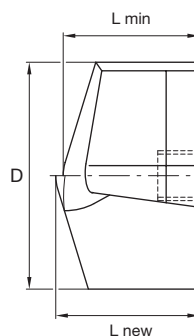
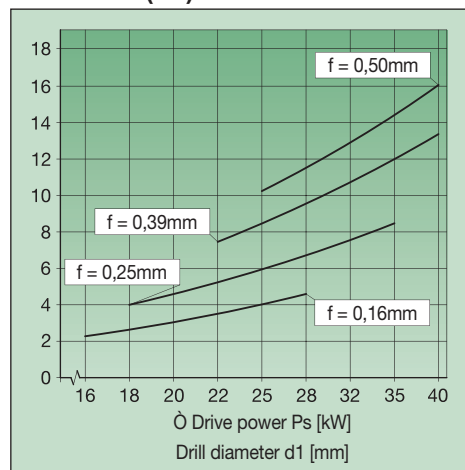

### Feed Force (kN)

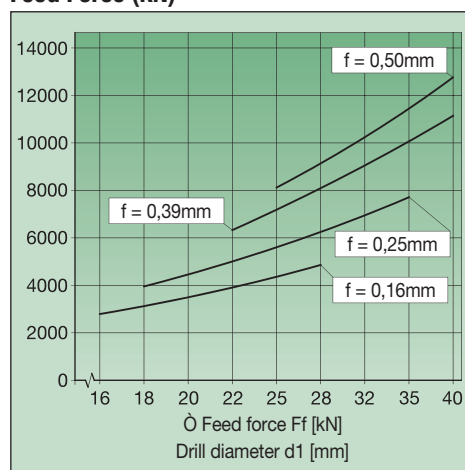

### Torque (Nm)

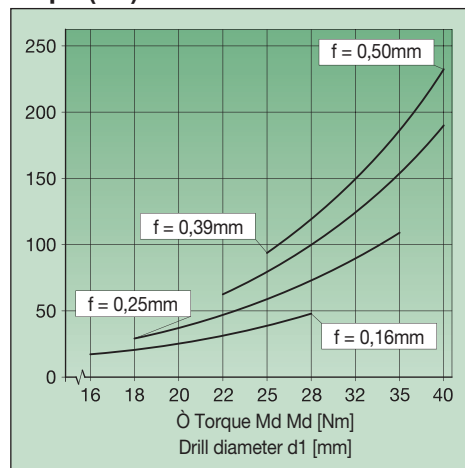

The following coolant pressure is recommended:

relative drilling depth	coolant pressure
1-3 x D	8 bars
5 x D	12 bars
7 x D	20 bars
10 x D	30 bars

SSC	diameter range D (mm)	L min. (mm)	L new (mm)
A	16-16.999	11.2	12.5
B	17-17.999	11.2	12.5
C	18-18.999	12.2	13.6
D	19-19.999	12.2	13.6
E	20-20.999	13.2	14.7
F	21-21.999	13.2	14.7
G	22-22.999	14.2	15.8
H	23-23.999	14.2	15.8
I	24-24.999	15.2	16.9
J	25-25.999	15.2	16.9
K	26-26.999	16.2	18
L	27-27.999	16.2	18
M	28-28.999	17.2	19.1
N	29-29.999	17.2	19.1
O	30-30.999	18.2	20.2
P	31-31.999	18.2	20.2
Q	32-33.999	20.1	22.3
R	34-35.999	20.1	22.3
S	36-37.999	22.1	24.5
T	38-40	22.1	24.5

NOTE: SSC = Pocket Seat Reference. To correspond with the SSC on the inserts.

NOTE: The diagrams above are used to determine the drive power, feed force, and torque. They are based on cutting force measurement in tempered steels in Cgr. 6. Tensile strength:  $R_m = 600 \text{ N/mm}^2$ . The base cutting speed used is:  $v_c = 80 \text{ m/min}$ .

# TOP CUT 4™



THE NEXT GENERATION  
OF INDEXABLE DRILLING





## One Comprehensive Platform

Standard diameter range covering 12–68mm  
in 2 x D, 3 x D, 4 x D, and 5 x D.

Four real cutting edges on each insert for entire platform.

Eight insert sizes to cover complete diameter range.

## Easy to Apply

No risk of mixing up inner and outer insert due to clear  
visual differences.

Easy-to-change inserts, laser marked with geometries and grades.

Easy-to-use nomenclature guide enabling the tool body and the  
related insert selection to avoid order failures.

## Highly Versatile

Breadth of application capabilities include through and cross holes,  
inclined entry and exit opportunity, 45° corner, half cylindrical,  
concave, or chain drilling.

Various geometries and grades available.

WIDIA™ Top Cut 4™ (TC4) portfolio is a broad offering for  
customers looking for a versatile indexable drilling platform.

**WIDIA** 

widia.com



# Top Cut 4™

## New Generation Indexable Drilling System



- 2x four true cutting edges.
- Cutting edge profile of central and periphery insert work together, leading to high stabilisation of the drill, preventing drifting of the tool even on irregular surfaces.
- X-offset design to adjust diameter size on turning machines and optimise tolerances on machining centres.
- Apply where speed and economy are prime considerations.
- Four grades to achieve higher tool life at accelerated speeds:
  - WU25CH grade for highest metal removal rate in general applications.
  - WU40PH grade for high toughness demands.
  - WPK10CH grade for high-speed applications.
  - WN10PH grade specific for aluminium and other non-ferrous materials.

### Chip Flute Exit

Steeper chip flute exit to reduce the overall length and increase rigidity.

### Coolant Channels

Enhanced coolant holes to get more lubrication at the cutting edge.

### SL Shank Style

Metric portfolio: shank sizes are 20mm, 25mm, 32mm, and 40mm, based on the cutting diameter for all the L/D ratios.

### Insert Positioning

Optimised insert positioning to achieve the maximum drill stability, hole tolerance and surface quality, above all in deep-drilling applications.

### Gash

Improved gash design on both insert pocket seats for a better chip evacuation.

## Top Cut 4 Inserts Expansion — Long Chip Materials — Non-Ferrous Materials.

-V34

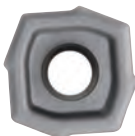

**P K**

First choice for machining Steel, Cast Iron, and short chipping materials. Suitable for severe cutting conditions.

-V36

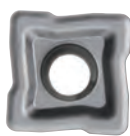

**P M K**

First choice for Stainless Steel. Suitable for deep drilling and where low power consumption is required.



-V36 WN10PH



**N**

First choice for Non-Ferrous materials.



-V38



**P M S**

Ideal for long chipping materials.

## New Generation Indexable Drilling System

### Top Cut 4™ Bodies Upgrade

Diameter 30mm, 4 x D example

Current

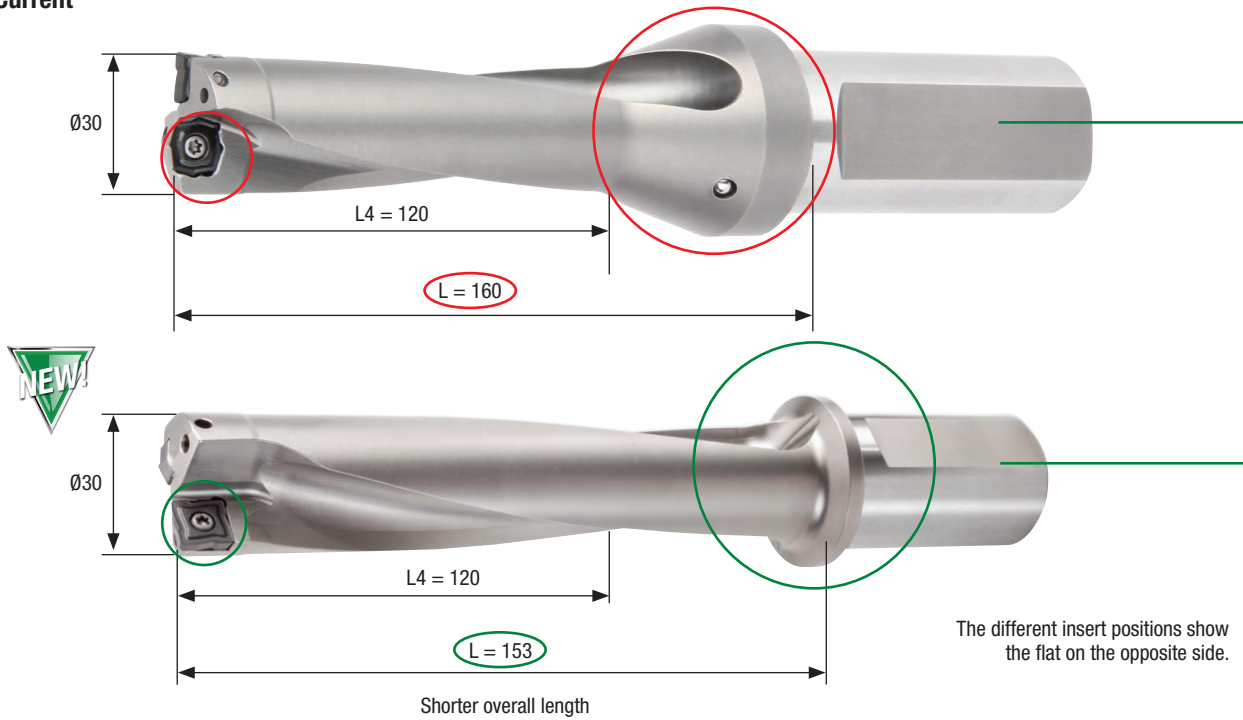

#### Gash

Optimised gash for improved chip flow and more precise insert pocket seat positioning.



# Top Cut 4™

Geometry and Grade Expansion for Augmented Versatility

## -V36 WN10PH for Non-Ferrous Materials

### Productivity

- Perfect combination of edge preparation and grade for aluminium machining.
- TiB<sub>2</sub> based coating specific for non-ferrous materials.
- Optimal chip control and no built-up edge, even in very soft aluminiums.

### Performance

- High cutting speed capability thanks to the state-of-the-art TiB<sub>2</sub> coating.
- The WN10PH grade geometry is available on the inboard insert, as well as on the outboard insert.
- Better general hole quality (surface and dimension) thanks to edge preparation and coating combination when compared to a standard universal insert.
- Longer and predictable tool life leads to avoiding the generation of built-up edge.

### Technical Details

- PSTS Inserts.
- Positive and sharp cutting edge.
- First choice for aluminium and others non-ferrous materials.
- Periphery insert with wiper land.



## Top Cut 4 Inserts Expansion — Non-Ferrous Materials.

-V36 WN10PH



N

First choice for Non-Ferrous materials.

## Hole Quality — Surface Finish

Diameter: 30mm 4 x D hole  
Material: GAISi 7 Mg

-V36 WN10PH

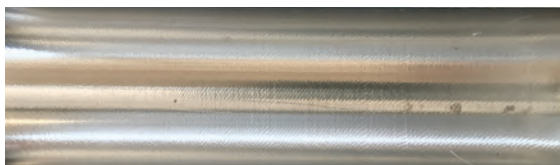

Standard multipurpose grade and geometry

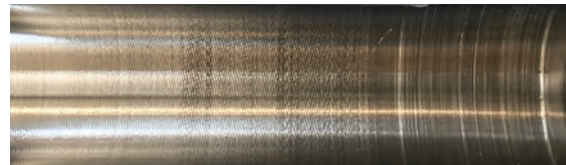

## Geometry and Grade Expansion for Augmented Versatility

### -V38 Chipbreaker

#### Productivity

- Eliminates the formation of bird-nesting on the tool in long chip materials drilling.
- Improves the chip formation dramatically to guarantee a smooth chip flow.
- No machine stops due to bad chip evacuation on low carbon steels, stainless steels, and titanium — high process reliability.

#### Performance

- Larger feed rate window compared to the -V36 geometry when applied to low carbon steels and stainless steel.
- -V38 geometry is available on the inboard insert, as well as on the outboard insert.
- Better general hole quality (surface and dimension) thanks to the improved chip flow:
  - No drifting of the tool body causing deviation in the hole size.
  - No contact of the chips with the hole surface causing bad finishing.

#### Technical Details

- PSTS inserts.
- Special edge geometry for more effective chipbreaking action.
- First choice for low carbon steel, stainless steel, and super alloys.
- Periphery insert with wiper land.



#### -V38 Chipbreaker Application Areas

The new -V38 geometry is the first choice when:

- The drilling application with Top Cut 4™ platform bodies and inserts is applied to:
  - Low carbon steel (typically P0 and P1).
  - Stainless steels, such as AISI304, AISI316, and similar materials.
  - Titanium alloys, like Grade 2 and Grade 5.
- Bird-nesting on the tool body is an issue.
- Vibrations are generated due to a bad chip flow. Chip can't evacuate from the hole and generates big noise during machining.
- Bad surface quality caused by the chip in contact with the hole.
- Bigger hole size. Bad chip flow can generate tool drifting.
- Lower power consumption and less torque are needed.

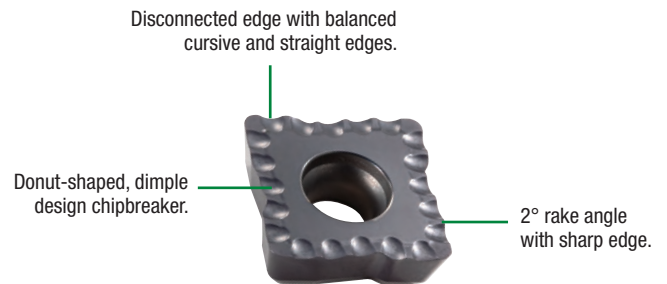

#### Top Cut 4 Inserts Expansion — Long Chip Materials.



**P M S**

Ideal for long chip materials.



# Top Cut 4™

## Top Cut 4 Shanks

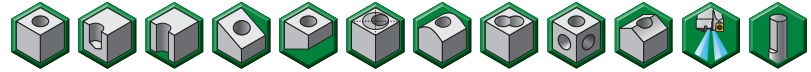

### ▼ Top Cut 4 Drill • Metric • 2 x D • SLR Shanks

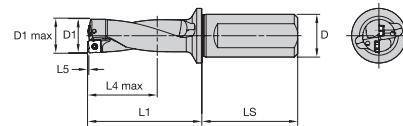

For information on LS, see the table on page 53.

order number	catalogue number	D1	D1 max	D	L1	L4 max	L5	SSC	periphery insert	centre insert
5537778	TCF120R2SLR20MA	12,00	12,50	20	43,4	24,4	0,43	A	TCF040204AP	TCF040203AC
5537779	TCF125R2SLR20MA	12,50	13,00	20	44,5	25,5	0,45	A	TCF040204AP	TCF040203AC
5537860	TCF127R2SLR20MA	12,70	13,20	20	45,9	25,9	0,46	A	TCF040204AP	TCF040203AC
5537861	TCF130R2SLR20MA	13,00	13,50	20	46,5	26,5	0,47	A	TCF040204AP	TCF040203AC
5537862	TCF135R2SLR20MA	13,50	14,00	20	48,5	27,5	0,48	A	TCF040204AP	TCF040203AC
5577828	TCF140R2SLR25MB	14,00	14,50	25	48,5	28,5	0,49	B	TCF050204BP	TCF060203BC
5577829	TCF145R2SLR25MB	14,50	15,00	25	49,5	29,5	0,52	B	TCF050204BP	TCF060203BC
5577920	TCF150R2SLR25MB	15,00	15,50	25	51,5	30,5	0,55	B	TCF050204BP	TCF060203BC
5577921	TCF155R2SLR25MB	15,50	16,00	25	53,6	31,6	0,56	B	TCF050204BP	TCF060203BC
5577922	TCF160R2SLR25MB	16,00	16,50	25	54,6	32,6	0,58	B	TCF050204BP	TCF060203BC
5577923	TCF165R2SLR25MB	16,50	17,00	25	56,6	33,6	0,60	B	TCF050204BP	TCF060203BC
5577924	TCF170R2SLR25MB	17,00	17,50	25	57,6	34,6	0,61	B	TCF050204BP	TCF060203BC
5577925	TCF175R2SLR25MB	17,50	18,00	25	59,6	35,6	0,63	B	TCF050204BP	TCF060203BC
5577926	TCF180R2SLR25MB	18,00	18,50	25	60,6	36,6	0,64	B	TCF050204BP	TCF060203BC
5577927	TCF185R2SLR25MB	18,50	19,00	25	62,7	37,7	0,65	B	TCF050204BP	TCF060203BC
5578820	TCF190R2SLR25MC	19,00	19,50	25	63,7	38,7	0,68	C	TCF070306CP	TCF070304CC
5578821	TCF195R2SLR25MC	19,50	20,00	25	65,7	39,7	0,71	C	TCF070306CP	TCF070304CC
5578822	TCF200R2SLR25MC	20,00	20,50	25	66,7	40,7	0,72	C	TCF070306CP	TCF070304CC
5578823	TCF205R2SLR25MC	20,50	21,00	25	68,7	41,7	0,74	C	TCF070306CP	TCF070304CC
5578824	TCF210R2SLR25MC	21,00	21,50	25	70,8	42,8	0,75	C	TCF070306CP	TCF070304CC
5578825	TCF220R2SLR25MC	22,00	22,50	25	73,8	44,8	0,78	C	TCF070306CP	TCF070304CC
5578826	TCF225R2SLR25MC	22,50	23,00	25	74,8	45,8	0,79	C	TCF070306CP	TCF070304CC
5578827	TCF230R2SLR25MC	23,00	23,50	25	76,8	46,8	0,80	C	TCF070306CP	TCF070304CC
5537167	TCF240R2SLR25MD	24,00	25,00	25	76,9	48,9	0,87	D	TCF080308DP	TCF090305DC
5537168	TCF250R2SLR32MD	25,00	26,00	32	80,9	50,9	0,91	D	TCF080308DP	TCF090305DC
5537169	TCF260R2SLR32MD	26,00	27,00	32	83,9	52,9	0,94	D	TCF080308DP	TCF090305DC
5537820	TCF265R2SLR32MD	26,50	27,50	32	86,0	54,0	0,95	D	TCF080308DP	TCF090305DC
5537821	TCF270R2SLR32MD	27,00	28,00	32	87,0	55,0	0,97	D	TCF080308DP	TCF090305DC
5537822	TCF280R2SLR32MD	28,00	29,00	32	90,0	57,0	0,99	D	TCF080308DP	TCF090305DC
5537823	TCF290R2SLR32MD	29,00	30,00	32	93,0	59,0	1,02	D	TCF080308DP	TCF090305DC
5537937	TCF300R2SLR32ME	30,00	31,00	32	93,1	61,1	1,09	E	TCF100408EP	TCF120405EC
5537938	TCF310R2SLR32ME	31,00	32,00	32	96,1	63,1	1,12	E	TCF100408EP	TCF120405EC
5537939	TCF320R2SLR32ME	32,00	33,00	32	99,2	65,2	1,15	E	TCF100408EP	TCF120405EC
5537940	TCF330R2SLR40ME	33,00	34,00	40	103,2	67,2	1,18	E	TCF100408EP	TCF120405EC
5537941	TCF340R2SLR40ME	34,00	35,00	40	106,2	69,2	1,21	E	TCF100408EP	TCF120405EC
5537942	TCF350R2SLR40ME	35,00	36,00	40	109,2	71,2	1,24	E	TCF100408EP	TCF120405EC
5537943	TCF360R2SLR40ME	36,00	37,00	40	112,3	73,3	1,27	E	TCF100408EP	TCF120405EC
5578539	TCF370R2SLR40MF	37,00	38,00	40	115,3	75,3	1,35	F	TCF120412FP	TCF150406FC
5578600	TCF375R2SLR40MF	37,50	38,50	40	116,4	76,4	1,36	F	TCF120412FP	TCF150406FC
5578601	TCF380R2SLR40MF	38,00	39,00	40	118,4	77,4	1,38	F	TCF120412FP	TCF150406FC
5578602	TCF390R2SLR40MF	39,00	40,00	40	121,4	79,4	1,41	F	TCF120412FP	TCF150406FC
5578603	TCF400R2SLR40MF	40,00	41,00	40	123,4	81,4	1,45	F	TCF120412FP	TCF150406FC
5578604	TCF410R2SLR40MF	41,00	42,00	40	126,5	83,5	1,48	F	TCF120412FP	TCF150406FC
5578605	TCF420R2SLR40MF	42,00	43,00	40	129,5	85,5	1,51	F	TCF120412FP	TCF150406FC
5578606	TCF430R2SLR40MF	43,00	44,00	40	132,5	87,5	1,53	F	TCF120412FP	TCF150406FC
5578607	TCF440R2SLR40MF	44,00	45,00	40	135,6	89,6	1,56	F	TCF120412FP	TCF150406FC
5578608	TCF450R2SLR40MF	45,00	46,00	40	138,6	91,6	1,59	F	TCF120412FP	TCF150406FC
5578694	TCF460R2SLR40MG	46,00	47,00	40	136,7	93,7	1,67	G	TCF150512GP	TCF180508GC
5578695	TCF470R2SLR40MG	47,00	48,00	40	139,7	95,7	1,70	G	TCF150512GP	TCF180508GC
5578696	TCF480R2SLR40MG	48,00	49,00	40	142,7	97,7	1,73	G	TCF150512GP	TCF180508GC
5578697	TCF490R2SLR40MG	49,00	50,00	40	145,8	99,8	1,76	G	TCF150512GP	TCF180508GC
5578698	TCF500R2SLR40MG	50,00	51,00	40	147,8	101,8	1,79	G	TCF150512GP	TCF180508GC

(continued)

(Top Cut 4 Drill • Metric • 2 x D • SLR Shanks — continued)

order number	catalogue number	D1	D1 max	D	L1	L4 max	L5	SSC	periphery insert	centre insert
5578699	TCF505R2SLR40MG	50,50	51,50	40	149,8	102,8	1,80	G	TCF150512GP	TCF180508GC
5578710	TCF510R2SLR40MG	51,00	52,00	40	150,8	103,8	1,81	G	TCF150512GP	TCF180508GC
5578711	TCF520R2SLR40MG	52,00	53,00	40	153,8	105,8	1,84	G	TCF150512GP	TCF180508GC
5578712	TCF530R2SLR40MG	53,00	54,00	40	156,9	107,9	1,87	G	TCF150512GP	TCF180508GC
5578713	TCF540R2SLR40MG	54,00	55,00	40	159,9	109,9	1,89	G	TCF150512GP	TCF180508GC
5578714	TCF550R2SLR40MG	55,00	56,00	40	161,9	111,9	1,92	G	TCF150512GP	TCF180508GC
5578715	TCF560R2SLR40MG	56,00	57,00	40	164,9	113,9	1,94	G	TCF150512GP	TCF180508GC
5538613	TCF570R2SLR40MH	57,00	58,00	40	162,1	116,1	2,06	H	TCF180614HP	TCF210608HC
5538614	TCF580R2SLR40MH	58,00	59,00	40	165,1	118,1	2,09	H	TCF180614HP	TCF210608HC
5538615	TCF590R2SLR40MH	59,00	60,00	40	168,1	120,1	2,12	H	TCF180614HP	TCF210608HC
5538616	TCF600R2SLR40MH	60,00	61,00	40	170,1	122,1	2,15	H	TCF180614HP	TCF210608HC
5538617	TCF610R2SLR40MH	61,00	62,00	40	173,2	124,2	2,18	H	TCF180614HP	TCF210608HC
5538618	TCF620R2SLR40MH	62,00	63,00	40	176,2	126,2	2,20	H	TCF180614HP	TCF210608HC
5538619	TCF630R2SLR40MH	63,00	64,00	40	179,2	128,2	2,23	H	TCF180614HP	TCF210608HC
5538630	TCF640R2SLR40MH	64,00	65,00	40	181,3	130,3	2,26	H	TCF180614HP	TCF210608HC
5538631	TCF650R2SLR40MH	65,00	66,00	40	184,3	132,3	2,28	H	TCF180614HP	TCF210608HC
5538632	TCF660R2SLR40MH	66,00	67,00	40	187,3	134,3	2,31	H	TCF180614HP	TCF210608HC
5538633	TCF670R2SLR40MH	67,00	68,00	40	189,3	136,3	2,33	H	TCF180614HP	TCF210608HC
5538634	TCF680R2SLR40MH	68,00	69,00	40	192,4	138,4	2,36	H	TCF180614HP	TCF210608HC

NOTE: SSC = Pocket Seat Reference. To correspond with the SSC on the inserts.

## ▼ Spare Parts



SSC	periphery insert	centre insert	insert screw order number	Torx size	Torx driver order number	tightening torque Nm
A	TCF040204AP	TCF040203AC	2025073	T5	2029221	0,40
B	TCF050204BP	TCF060203BC	1175225	T6	1138455	0,53
C	TCF070306CP	TCF070304CC	1021337	T7	2029266	0,90
D	TCF080308DP	TCF090305DC	1134385	T8	2029598	1,10
E	TCF100408EP	TCF120405EC	2018194	T9	1138430	2,00
F	TCF120412FP	TCF150406FC	1756815	T15	1138455	4,00
G	TCF150512GP	TCF180508GC	1099645	T20	1138455	6,30
H	TCF180614HP	TCF210608HC	1823871	T25	1022519	8,80
H	TCF180614HP	TCF210608HC	1823871	T25	1138455	8,80

NOTE: Drilling in stacked plates possible in certain applications. Ask for technical support.

Drill shipped with insert screws and Torx wrench.

See pages 60–63 for inserts.

SSC = Pocket Seat Reference.

SLR = Side Lock.

D1 max is an achievable diameter using x-offset.

D	LS
20,00	50
25,00	56
32,00	60
40,00	70



**WARNING**  
During through-hole operations, a slug or disc is produced as the tool breaks through the workpiece. When the drill is stationary and the workpiece is rotating, this slug may be hurled from the chuck by centrifugal force. Provide adequate shielding to protect bystanders.

# Top Cut 4™

## Top Cut 4 Shanks



### ▼ Top Cut 4 Drill • Metric • 3 x D • SLR Shanks

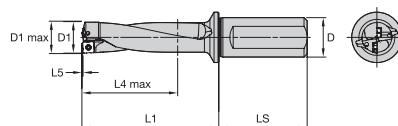

For information on L5, see the table on page 55.

order number	catalogue number	D1	D1 max	D	L1	L4 max	L5	SSC	periphery insert	centre insert
5537863	TCF120R3SLR20MA	12,00	12,50	20	55,4	36,4	0,43	A	TCF040204AP	TCF040203AC
5537864	TCF125R3SLR20MA	12,50	13,00	20	57,0	38,0	0,45	A	TCF040204AP	TCF040203AC
5537866	TCF127R3SLR20MA	12,70	13,20	20	58,6	38,6	0,46	A	TCF040204AP	TCF040203AC
5537867	TCF130R3SLR20MA	13,00	13,50	20	59,5	39,5	0,47	A	TCF040204AP	TCF040203AC
5537868	TCF135R3SLR20MA	13,50	14,00	20	61,0	41,0	0,48	A	TCF040204AP	TCF040203AC
5577928	TCF140R3SLR25MB	14,00	14,50	25	62,5	42,5	0,49	B	TCF050204BP	TCF060203BC
5577929	TCF145R3SLR25MB	14,50	15,00	25	64,0	44,0	0,52	B	TCF050204BP	TCF060203BC
5577930	TCF150R3SLR25MB	15,00	15,50	25	66,5	45,5	0,55	B	TCF050204BP	TCF060203BC
5577931	TCF155R3SLR25MB	15,50	16,00	25	69,1	47,1	0,56	B	TCF050204BP	TCF060203BC
5577932	TCF160R3SLR25MB	16,00	16,50	25	70,6	48,6	0,58	B	TCF050204BP	TCF060203BC
5577933	TCF165R3SLR25MB	16,50	17,00	25	73,1	50,1	0,60	B	TCF050204BP	TCF060203BC
5577934	TCF170R3SLR25MB	17,00	17,50	25	74,6	51,6	0,61	B	TCF050204BP	TCF060203BC
5577935	TCF175R3SLR25MB	17,50	18,00	25	77,1	53,1	0,63	B	TCF050204BP	TCF060203BC
5577936	TCF180R3SLR25MB	18,00	18,50	25	78,6	54,6	0,64	B	TCF050204BP	TCF060203BC
5577937	TCF185R3SLR25MB	18,50	19,00	25	81,2	56,2	0,65	B	TCF050204BP	TCF060203BC
5578828	TCF190R3SLR25MC	19,00	19,50	25	82,7	57,7	0,68	C	TCF070306CP	TCF070304CC
5578829	TCF195R3SLR25MC	19,50	20,00	25	85,2	59,2	0,71	C	TCF070306CP	TCF070304CC
5578830	TCF200R3SLR25MC	20,00	20,50	25	86,7	60,7	0,72	C	TCF070306CP	TCF070304CC
5578831	TCF205R3SLR25MC	20,50	21,00	25	89,2	62,2	0,74	C	TCF070306CP	TCF070304CC
5578832	TCF210R3SLR25MC	21,00	21,50	25	91,8	63,8	0,75	C	TCF070306CP	TCF070304CC
5578833	TCF220R3SLR25MC	22,00	22,50	25	95,8	66,8	0,78	C	TCF070306CP	TCF070304CC
5578834	TCF225R3SLR25MC	22,50	23,00	25	97,3	68,3	0,79	C	TCF070306CP	TCF070304CC
5578835	TCF230R3SLR25MC	23,00	23,50	25	99,8	69,8	0,80	C	TCF070306CP	TCF070304CC
5537824	TCF240R3SLR25MD	24,00	25,00	25	100,9	72,9	0,87	D	TCF080308DP	TCF090305DC
5537825	TCF250R3SLR32MD	25,00	26,00	32	105,9	75,9	0,91	D	TCF080308DP	TCF090305DC
5537826	TCF260R3SLR32MD	26,00	27,00	32	109,9	78,9	0,94	D	TCF080308DP	TCF090305DC
5537827	TCF265R3SLR32MD	26,50	27,50	32	112,5	80,5	0,95	D	TCF080308DP	TCF090305DC
5537828	TCF270R3SLR32MD	27,00	28,00	32	114,0	82,0	0,97	D	TCF080308DP	TCF090305DC
5537829	TCF280R3SLR32MD	28,00	29,00	32	118,0	85,0	0,99	D	TCF080308DP	TCF090305DC
5537830	TCF290R3SLR32MD	29,00	30,00	32	122,0	88,0	1,02	D	TCF080308DP	TCF090305DC
5537944	TCF300R3SLR32ME	30,00	31,00	32	123,1	91,1	1,09	E	TCF100408EP	TCF120405EC
5537945	TCF310R3SLR32ME	31,00	32,00	32	127,1	94,1	1,12	E	TCF100408EP	TCF120405EC
5537946	TCF320R3SLR32ME	32,00	33,00	32	131,2	97,2	1,15	E	TCF100408EP	TCF120405EC
5537947	TCF330R3SLR40ME	33,00	34,00	40	136,2	100,2	1,18	E	TCF100408EP	TCF120405EC
5537948	TCF340R3SLR40ME	34,00	35,00	40	140,2	103,2	1,21	E	TCF100408EP	TCF120405EC
5537949	TCF350R3SLR40ME	35,00	36,00	40	144,2	106,2	1,24	E	TCF100408EP	TCF120405EC
5537950	TCF360R3SLR40ME	36,00	37,00	40	148,3	109,3	1,27	E	TCF100408EP	TCF120405EC
5578609	TCF370R3SLR40MF	37,00	38,00	40	152,3	112,3	1,35	F	TCF120412FP	TCF150406FC
5578610	TCF375R3SLR40MF	37,50	38,50	40	153,9	113,9	1,36	F	TCF120412FP	TCF150406FC
5578611	TCF380R3SLR40MF	38,00	39,00	40	156,4	115,4	1,38	F	TCF120412FP	TCF150406FC
5578612	TCF390R3SLR40MF	39,00	40,00	40	160,4	118,4	1,41	F	TCF120412FP	TCF150406FC
5578613	TCF400R3SLR40MF	40,00	41,00	40	163,4	121,4	1,45	F	TCF120412FP	TCF150406FC
5578614	TCF410R3SLR40MF	41,00	42,00	40	167,5	124,5	1,48	F	TCF120412FP	TCF150406FC
5578615	TCF420R3SLR40MF	42,00	43,00	40	171,5	127,5	1,51	F	TCF120412FP	TCF150406FC
5578616	TCF430R3SLR40MF	43,00	44,00	40	175,5	130,5	1,53	F	TCF120412FP	TCF150406FC
5578617	TCF440R3SLR40MF	44,00	45,00	40	179,6	133,6	1,56	F	TCF120412FP	TCF150406FC
5578618	TCF450R3SLR40MF	45,00	46,00	40	183,6	136,6	1,59	F	TCF120412FP	TCF150406FC
5578716	TCF460R3SLR40MG	46,00	47,00	40	182,7	139,7	1,67	G	TCF150512GP	TCF180508GC
5578717	TCF470R3SLR40MG	47,00	48,00	40	186,7	142,7	1,70	G	TCF150512GP	TCF180508GC
5578718	TCF480R3SLR40MG	48,00	49,00	40	190,7	145,7	1,73	G	TCF150512GP	TCF180508GC
5578719	TCF490R3SLR40MG	49,00	50,00	40	194,8	148,8	1,76	G	TCF150512GP	TCF180508GC
5578720	TCF500R3SLR40MG	50,00	51,00	40	197,8	151,8	1,79	G	TCF150512GP	TCF180508GC

(continued)

(Top Cut 4 Drill • Metric • 3 x D • SLR Shanks — continued)

order number	catalogue number	D1	D1 max	D	L1	L4 max	L5	SSC	periphery insert	centre insert
5578721	TCF505R3SLR40MG	50,50	51,50	40	200,3	153,3	1,80	G	TCF150512GP	TCF180508GC
5578722	TCF510R3SLR40MG	51,00	52,00	40	201,8	154,8	1,81	G	TCF150512GP	TCF180508GC
5578723	TCF520R3SLR40MG	52,00	53,00	40	205,8	157,8	1,84	G	TCF150512GP	TCF180508GC
5578724	TCF530R3SLR40MG	53,00	54,00	40	209,9	160,9	1,87	G	TCF150512GP	TCF180508GC
5578726	TCF540R3SLR40MG	54,00	55,00	40	213,9	163,9	1,89	G	TCF150512GP	TCF180508GC
5578727	TCF550R3SLR40MG	55,00	56,00	40	216,9	166,9	1,92	G	TCF150512GP	TCF180508GC
5578728	TCF560R3SLR40MG	56,00	57,00	40	220,9	169,9	1,94	G	TCF150512GP	TCF180508GC
5538635	TCF570R3SLR40MH	57,00	58,00	40	219,1	173,1	2,06	H	TCF180614HP	TCF210608HC
5538636	TCF580R3SLR40MH	58,00	59,00	40	223,1	176,1	2,09	H	TCF180614HP	TCF210608HC
5538637	TCF590R3SLR40MH	59,00	60,00	40	227,1	179,1	2,12	H	TCF180614HP	TCF210608HC
5538638	TCF600R3SLR40MH	60,00	61,00	40	230,1	182,1	2,15	H	TCF180614HP	TCF210608HC
5538639	TCF610R3SLR40MH	61,00	62,00	40	234,2	185,2	2,18	H	TCF180614HP	TCF210608HC
5538640	TCF620R3SLR40MH	62,00	63,00	40	238,2	188,2	2,20	H	TCF180614HP	TCF210608HC
5538641	TCF630R3SLR40MH	63,00	64,00	40	242,2	191,2	2,23	H	TCF180614HP	TCF210608HC
5538642	TCF640R3SLR40MH	64,00	65,00	40	245,3	194,3	2,26	H	TCF180614HP	TCF210608HC
5538643	TCF650R3SLR40MH	65,00	66,00	40	249,3	197,3	2,28	H	TCF180614HP	TCF210608HC
5538644	TCF660R3SLR40MH	66,00	67,00	40	253,3	200,3	2,31	H	TCF180614HP	TCF210608HC
5538645	TCF670R3SLR40MH	67,00	68,00	40	256,3	203,3	2,33	H	TCF180614HP	TCF210608HC
5538646	TCF680R3SLR40MH	68,00	69,00	40	260,4	206,4	2,36	H	TCF180614HP	TCF210608HC

NOTE: SSC = Pocket Seat Reference. To correspond with the SSC on the inserts.

## ▼ Spare Parts



SSC	periphery insert	centre insert	insert screw order number	Torx size	Torx driver order number	tightening torque Nm
A	TCF040204AP	TCF040203AC	2025073	T5	2029221	0,40
B	TCF050204BP	TCF060203BC	1175225	T6	1138455	0,53
C	TCF070306CP	TCF070304CC	1021337	T7	2029266	0,90
D	TCF080308DP	TCF090305DC	1134385	T8	2029598	1,10
E	TCF100408EP	TCF120405EC	2018194	T9	1138430	2,00
F	TCF120412FP	TCF150406FC	1756815	T15	1138455	4,00
F	TCF120412FP	TCF150406FC	1756815	T15	2029596	4,00
G	TCF150512GP	TCF180508GC	1099645	T20	1138455	6,30
H	TCF180614HP	TCF210608HC	1823871	T25	1022519	8,80
H	TCF180614HP	TCF210608HC	1823871	T25	1138455	8,80

NOTE: Drilling in stacked plates possible in certain applications. Ask for technical support.

Drill shipped with insert screws and Torx wrench.

See pages 60–63 for inserts.

SSC = Pocket Seat Reference.

SLR = Side Lock.

D1 max is an achievable diameter using x-offset.

D	LS
20,00	50
25,00	56
32,00	60
40,00	70

**WARNING**

During through-hole operations, a slug or disc is produced as the tool breaks through the workpiece. When the drill is stationary and the workpiece is rotating, this slug may be hurled from the chuck by centrifugal force. Provide adequate shielding to protect bystanders.



# Top Cut 4™

## Top Cut 4 Shanks

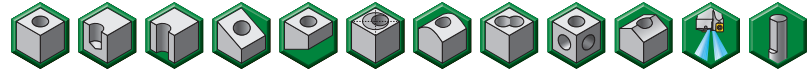

### ▼ Top Cut 4 Drill • Metric • 4 x D • SLR Shanks

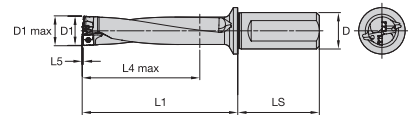

For information on LS, see the table on page 57.

order number	catalogue number	D1	D1 max	D	L1	L4 max	L5	SSC	periphery insert	centre insert
5537869	TCF120R4SLR20MA	12,00	12,50	20	67,4	48,4	0,43	A	TCF040204AP	TCF040203AC
5537870	TCF125R4SLR20MA	12,50	13,00	20	69,5	50,5	0,45	A	TCF040204AP	TCF040203AC
5537871	TCF127R4SLR20MA	12,70	13,20	20	71,3	51,3	0,46	A	TCF040204AP	TCF040203AC
5537872	TCF130R4SLR20MA	13,00	13,50	20	72,5	52,5	0,47	A	TCF040204AP	TCF040203AC
5537873	TCF135R4SLR20MA	13,50	14,00	20	75,5	54,5	0,48	A	TCF040204AP	TCF040203AC
5577938	TCF140R4SLR25MB	14,00	14,50	25	76,5	56,5	0,49	B	TCF050204BP	TCF060203BC
5577939	TCF145R4SLR25MB	14,50	15,00	25	78,5	58,5	0,52	B	TCF050204BP	TCF060203BC
5577940	TCF150R4SLR25MB	15,00	15,50	25	81,5	60,5	0,55	B	TCF050204BP	TCF060203BC
5577941	TCF155R4SLR25MB	15,50	16,00	25	84,6	62,6	0,56	B	TCF050204BP	TCF060203BC
5577942	TCF160R4SLR25MB	16,00	16,50	25	86,6	64,6	0,58	B	TCF050204BP	TCF060203BC
5577943	TCF165R4SLR25MB	16,50	17,00	25	89,6	66,6	0,60	B	TCF050204BP	TCF060203BC
5577944	TCF170R4SLR25MB	17,00	17,50	25	91,6	68,6	0,61	B	TCF050204BP	TCF060203BC
5577945	TCF175R4SLR25MB	17,50	18,00	25	94,6	70,6	0,63	B	TCF050204BP	TCF060203BC
5577946	TCF180R4SLR25MB	18,00	18,50	25	96,6	72,6	0,64	B	TCF050204BP	TCF060203BC
5577947	TCF185R4SLR25MB	18,50	19,00	25	99,7	74,7	0,65	B	TCF050204BP	TCF060203BC
5578836	TCF190R4SLR25MC	19,00	19,50	25	101,7	76,7	0,68	C	TCF070306CP	TCF070304CC
5578837	TCF195R4SLR25MC	19,50	20,00	25	104,7	78,7	0,71	C	TCF070306CP	TCF070304CC
5578838	TCF200R4SLR25MC	20,00	20,50	25	106,7	80,7	0,72	C	TCF070306CP	TCF070304CC
5578839	TCF205R4SLR25MC	20,50	21,00	25	109,7	82,7	0,74	C	TCF070306CP	TCF070304CC
5578840	TCF210R4SLR25MC	21,00	21,50	25	112,8	84,8	0,75	C	TCF070306CP	TCF070304CC
5578841	TCF220R4SLR25MC	22,00	22,50	25	117,8	88,8	0,78	C	TCF070306CP	TCF070304CC
5578842	TCF225R4SLR25MC	22,50	23,00	25	119,8	90,8	0,79	C	TCF070306CP	TCF070304CC
5578843	TCF230R4SLR25MC	23,00	23,50	25	122,8	92,8	0,80	C	TCF070306CP	TCF070304CC
5537831	TCF240R4SLR25MD	24,00	25,00	25	124,9	96,9	0,87	D	TCF080308DP	TCF090305DC
5537832	TCF250R4SLR32MD	25,00	26,00	32	130,9	100,9	0,91	D	TCF080308DP	TCF090305DC
5537833	TCF260R4SLR32MD	26,00	27,00	32	135,9	104,9	0,94	D	TCF080308DP	TCF090305DC
5537834	TCF265R4SLR32MD	26,50	27,50	32	139,0	107,0	0,95	D	TCF080308DP	TCF090305DC
5537835	TCF270R4SLR32MD	27,00	28,00	32	141,0	109,0	0,97	D	TCF080308DP	TCF090305DC
5537836	TCF280R4SLR32MD	28,00	29,00	32	146,0	113,0	0,99	D	TCF080308DP	TCF090305DC
5537837	TCF290R4SLR32MD	29,00	30,00	32	151,0	117,0	1,02	D	TCF080308DP	TCF090305DC
5537951	TCF300R4SLR32ME	30,00	31,00	32	153,1	121,1	1,09	E	TCF100408EP	TCF120405EC
5537952	TCF310R4SLR32ME	31,00	32,00	32	158,1	125,1	1,12	E	TCF100408EP	TCF120405EC
5537953	TCF320R4SLR32ME	32,00	33,00	32	163,2	129,2	1,15	E	TCF100408EP	TCF120405EC
5537954	TCF330R4SLR40ME	33,00	34,00	40	165,2	133,2	1,18	E	TCF100408EP	TCF120405EC
5537955	TCF340R4SLR40ME	34,00	35,00	40	174,2	137,2	1,21	E	TCF100408EP	TCF120405EC
5537956	TCF350R4SLR40ME	35,00	36,00	40	179,2	141,2	1,24	E	TCF100408EP	TCF120405EC
5537957	TCF360R4SLR40ME	36,00	37,00	40	184,3	145,3	1,27	E	TCF100408EP	TCF120405EC
5578619	TCF370R4SLR40MF	37,00	38,00	40	189,3	149,3	1,35	F	TCF120412FP	TCF150406FC
5578620	TCF375R4SLR40MF	37,50	38,50	40	191,4	151,4	1,36	F	TCF120412FP	TCF150406FC
5578621	TCF380R4SLR40MF	38,00	39,00	40	194,4	153,4	1,38	F	TCF120412FP	TCF150406FC
5578622	TCF390R4SLR40MF	39,00	40,00	40	199,4	157,4	1,41	F	TCF120412FP	TCF150406FC
5578623	TCF400R4SLR40MF	40,00	41,00	40	203,4	161,4	1,45	F	TCF120412FP	TCF150406FC
5578624	TCF410R4SLR40MF	41,00	42,00	40	208,5	165,5	1,48	F	TCF120412FP	TCF150406FC
5578625	TCF420R4SLR40MF	42,00	43,00	40	213,5	169,5	1,51	F	TCF120412FP	TCF150406FC
5578626	TCF430R4SLR40MF	43,00	44,00	40	218,5	173,5	1,53	F	TCF120412FP	TCF150406FC
5578627	TCF440R4SLR40MF	44,00	45,00	40	223,6	177,6	1,56	F	TCF120412FP	TCF150406FC
5578628	TCF450R4SLR40MF	45,00	46,00	40	228,6	181,6	1,59	F	TCF120412FP	TCF150406FC
5578729	TCF460R4SLR40MG	46,00	47,00	40	228,7	185,7	1,67	G	TCF150512GP	TCF180508GC
5578730	TCF470R4SLR40MG	47,00	48,00	40	233,7	189,7	1,70	G	TCF150512GP	TCF180508GC
5578731	TCF480R4SLR40MG	48,00	49,00	40	238,7	193,7	1,73	G	TCF150512GP	TCF180508GC
5578732	TCF490R4SLR40MG	49,00	50,00	40	243,8	197,8	1,76	G	TCF150512GP	TCF180508GC
5578733	TCF500R4SLR40MG	50,00	51,00	40	247,8	201,8	1,79	G	TCF150512GP	TCF180508GC

(continued)

(Top Cut 4 Drill • Metric • 4 x D • SLR Shanks — continued)

order number	catalogue number	D1	D1 max	D	L1	L4 max	L5	SSC	periphery insert	centre insert
5578734	TCF505R4SLR40MG	50,50	51,50	40	250,8	203,8	1,80	G	TCF150512GP	TCF180508GC
5578735	TCF510R4SLR40MG	51,00	52,00	40	252,8	205,8	1,81	G	TCF150512GP	TCF180508GC
5578736	TCF520R4SLR40MG	52,00	53,00	40	257,8	209,8	1,84	G	TCF150512GP	TCF180508GC
5578737	TCF530R4SLR40MG	53,00	54,00	40	262,9	213,9	1,87	G	TCF150512GP	TCF180508GC
5578738	TCF540R4SLR40MG	54,00	55,00	40	267,9	217,9	1,89	G	TCF150512GP	TCF180508GC
5578739	TCF550R4SLR40MG	55,00	56,00	40	271,9	221,9	1,92	G	TCF150512GP	TCF180508GC
5578750	TCF560R4SLR40MG	56,00	57,00	40	276,9	225,9	1,94	G	TCF150512GP	TCF180508GC
5538647	TCF570R4SLR40MH	57,00	58,00	40	276,1	230,1	2,06	H	TCF180614HP	TCF210608HC
5538648	TCF580R4SLR40MH	58,00	59,00	40	281,1	234,1	2,09	H	TCF180614HP	TCF210608HC
5538649	TCF590R4SLR40MH	59,00	60,00	40	286,1	238,1	2,12	H	TCF180614HP	TCF210608HC
5538650	TCF600R4SLR40MH	60,00	61,00	40	290,1	242,1	2,15	H	TCF180614HP	TCF210608HC
5538651	TCF610R4SLR40MH	61,00	62,00	40	295,2	246,2	2,18	H	TCF180614HP	TCF210608HC
5538652	TCF620R4SLR40MH	62,00	63,00	40	300,2	250,2	2,20	H	TCF180614HP	TCF210608HC
5538653	TCF630R4SLR40MH	63,00	64,00	40	305,2	254,2	2,23	H	TCF180614HP	TCF210608HC
5538654	TCF640R4SLR40MH	64,00	65,00	40	309,3	258,3	2,26	H	TCF180614HP	TCF210608HC
5538655	TCF650R4SLR40MH	65,00	66,00	40	314,3	262,3	2,28	H	TCF180614HP	TCF210608HC
5538656	TCF660R4SLR40MH	66,00	67,00	40	319,3	266,3	2,31	H	TCF180614HP	TCF210608HC
5538657	TCF670R4SLR40MH	67,00	68,00	40	323,3	270,3	2,33	H	TCF180614HP	TCF210608HC
5538658	TCF680R4SLR40MH	68,00	69,00	40	328,4	274,4	2,36	H	TCF180614HP	TCF210608HC

NOTE: SSC = Pocket Seat Reference. To correspond with the SSC on the inserts.

## ▼ Spare Parts



SSC	periphery insert	centre insert	insert screw order number	Torx size	Torx driver order number	tightening torque Nm
A	TCF040204AP	TCF040203AC	2025073	T5	2029221	0,40
B	TCF050204BP	TCF060203BC	1175225	T6	1138455	0,53
C	TCF070306CP	TCF070304CC	1021337	T7	2029266	0,90
D	TCF080308DP	TCF090305DC	1134385	T8	2029598	1,10
E	TCF100408EP	TCF120405EC	2018194	T9	1138430	2,00
F	TCF120412FP	TCF150406FC	1756815	T15	1138455	4,00
F	TCF120412FP	TCF150406FC	1756815	T15	2029596	4,00
G	TCF150512GP	TCF180508GC	1099645	T20	1138455	6,30
H	TCF180614HP	TCF210608HC	1823871	T25	1022519	8,80
H	TCF180614HP	TCF210608HC	1823871	T25	1138455	8,80

NOTE: Drilling in stacked plates possible in certain applications. Ask for technical support.

Drill shipped with insert screws and Torx wrench.

See pages 60–63 for inserts.

SSC = Pocket Seat Reference.

SLR = Side Lock.

D1 max is an achievable diameter using x-offset.

D	LS
20,00	50
25,00	56
32,00	60
40,00	70

**WARNING**

During through-hole operations, a slug or disc is produced as the tool breaks through the workpiece. When the drill is stationary and the workpiece is rotating, this slug may be hurled from the chuck by centrifugal force. Provide adequate shielding to protect bystanders.

# Top Cut 4™

## Top Cut 4 Shanks



### ▼ Top Cut 4 Drill • Metric • 5 x D • SLR Shanks

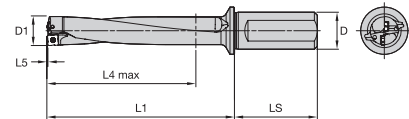

For information on L5, see the table on page 59.

order number	catalogue number	D1	D	L1	L4 max	L5	SSC	periphery insert	centre insert
5537874	TCF120R5SLR20MA	12,00	20	79,4	60,4	0,43	A	TCF040204AP	TCF040203AC
5537875	TCF125R5SLR20MA	12,50	20	82,0	63,0	0,45	A	TCF040204AP	TCF040203AC
5537876	TCF127R5SLR20MA	12,70	20	84,0	64,0	0,46	A	TCF040204AP	TCF040203AC
5537877	TCF130R5SLR20MA	13,00	20	85,5	65,5	0,47	A	TCF040204AP	TCF040203AC
5537878	TCF135R5SLR20MA	13,50	20	89,0	68,0	0,48	A	TCF040204AP	TCF040203AC
5577948	TCF140R5SLR25MB	14,00	25	90,5	70,5	0,49	B	TCF050204BP	TCF060203BC
5577949	TCF145R5SLR25MB	14,50	25	93,0	73,0	0,52	B	TCF050204BP	TCF060203BC
5577950	TCF150R5SLR25MB	15,00	25	96,5	75,5	0,55	B	TCF050204BP	TCF060203BC
5577951	TCF155R5SLR25MB	15,50	25	100,1	78,1	0,56	B	TCF050204BP	TCF060203BC
5577952	TCF160R5SLR25MB	16,00	25	102,6	80,6	0,58	B	TCF050204BP	TCF060203BC
5577953	TCF165R5SLR25MB	16,50	25	106,1	83,1	0,60	B	TCF050204BP	TCF060203BC
5577954	TCF170R5SLR25MB	17,00	25	108,6	85,6	0,61	B	TCF050204BP	TCF060203BC
5577955	TCF175R5SLR25MB	17,50	25	112,1	88,1	0,63	B	TCF050204BP	TCF060203BC
5577956	TCF180R5SLR25MB	18,00	25	114,6	90,6	0,64	B	TCF050204BP	TCF060203BC
5577957	TCF185R5SLR25MB	18,50	25	118,2	93,2	0,65	B	TCF050204BP	TCF060203BC
5578844	TCF190R5SLR25MC	19,00	25	120,7	95,7	0,68	C	TCF070306CP	TCF070304CC
5578845	TCF195R5SLR25MC	19,50	25	124,2	98,2	0,71	C	TCF070306CP	TCF070304CC
5578846	TCF200R5SLR25MC	20,00	25	126,7	100,7	0,72	C	TCF070306CP	TCF070304CC
5578847	TCF205R5SLR25MC	20,50	25	130,2	103,2	0,74	C	TCF070306CP	TCF070304CC
5578848	TCF210R5SLR25MC	21,00	25	133,8	105,8	0,75	C	TCF070306CP	TCF070304CC
5578849	TCF220R5SLR25MC	22,00	25	139,8	110,8	0,78	C	TCF070306CP	TCF070304CC
5578850	TCF225R5SLR25MC	22,50	25	142,3	113,3	0,79	C	TCF070306CP	TCF070304CC
5578851	TCF230R5SLR25MC	23,00	25	145,8	115,8	0,80	C	TCF070306CP	TCF070304CC
5537838	TCF240R5SLR25MD	24,00	25	148,9	120,9	0,87	D	TCF080308DP	TCF090305DC
5537839	TCF250R5SLR32MD	25,00	32	155,9	125,9	0,91	D	TCF080308DP	TCF090305DC
5537840	TCF260R5SLR32MD	26,00	32	161,9	130,9	0,94	D	TCF080308DP	TCF090305DC
5537841	TCF265R5SLR32MD	26,50	32	165,5	133,5	0,95	D	TCF080308DP	TCF090305DC
5537842	TCF270R5SLR32MD	27,00	32	168,0	136,0	0,97	D	TCF080308DP	TCF090305DC
5537843	TCF280R5SLR32MD	28,00	32	174,0	141,0	0,99	D	TCF080308DP	TCF090305DC
5537844	TCF290R5SLR32MD	29,00	32	180,0	146,0	1,02	D	TCF080308DP	TCF090305DC
5537958	TCF300R5SLR32ME	30,00	32	183,1	151,1	1,09	E	TCF100408EP	TCF120405EC
5537959	TCF310R5SLR32ME	31,00	32	189,1	156,1	1,12	E	TCF100408EP	TCF120405EC
5537960	TCF320R5SLR32ME	32,00	32	195,2	161,2	1,15	E	TCF100408EP	TCF120405EC
5537961	TCF330R5SLR40ME	33,00	40	202,2	166,2	1,18	E	TCF100408EP	TCF120405EC
5537962	TCF340R5SLR40ME	34,00	40	208,2	171,2	1,21	E	TCF100408EP	TCF120405EC
5537963	TCF350R5SLR40ME	35,00	40	214,2	176,2	1,24	E	TCF100408EP	TCF120405EC
5537964	TCF360R5SLR40ME	36,00	40	220,3	181,3	1,27	E	TCF100408EP	TCF120405EC
5578629	TCF370R5SLR40MF	37,00	40	226,3	186,3	1,35	F	TCF120412FP	TCF150406FC
5578640	TCF375R5SLR40MF	37,50	40	228,9	188,9	1,36	F	TCF120412FP	TCF150406FC
5578641	TCF380R5SLR40MF	38,00	40	232,4	191,4	1,38	F	TCF120412FP	TCF150406FC
5578642	TCF390R5SLR40MF	39,00	40	238,4	196,4	1,41	F	TCF120412FP	TCF150406FC
5578643	TCF400R5SLR40MF	40,00	40	243,4	201,4	1,45	F	TCF120412FP	TCF150406FC
5578644	TCF410R5SLR40MF	41,00	40	249,5	206,5	1,48	F	TCF120412FP	TCF150406FC
5578645	TCF420R5SLR40MF	42,00	40	255,5	211,5	1,51	F	TCF120412FP	TCF150406FC
5578646	TCF430R5SLR40MF	43,00	40	261,5	216,5	1,53	F	TCF120412FP	TCF150406FC
5578647	TCF440R5SLR40MF	44,00	40	267,6	221,6	1,56	F	TCF120412FP	TCF150406FC
5578648	TCF450R5SLR40MF	45,00	40	273,6	226,6	1,59	F	TCF120412FP	TCF150406FC
5578751	TCF460R5SLR40MG	46,00	40	274,7	231,7	1,67	G	TCF150512GP	TCF180508GC
5578752	TCF470R5SLR40MG	47,00	40	280,7	236,7	1,70	G	TCF150512GP	TCF180508GC
5578753	TCF480R5SLR40MG	48,00	40	286,7	241,7	1,73	G	TCF150512GP	TCF180508GC
5578754	TCF490R5SLR40MG	49,00	40	292,8	246,8	1,76	G	TCF150512GP	TCF180508GC
5578755	TCF500R5SLR40MG	50,00	40	297,8	251,8	1,79	G	TCF150512GP	TCF180508GC

(continued)

(Top Cut 4 Drill • Metric • 5 x D • SLR Shank – continued)

order number	catalogue number	D1	D	L1	L4 max	L5	SSC	periphery insert	centre insert
5578756	TCF505R5SLR40MG	50,50	40	301,3	254,3	1,80	G	TCF150512GP	TCF180508GC
5578757	TCF510R5SLR40MG	51,00	40	303,8	256,8	1,81	G	TCF150512GP	TCF180508GC
5578758	TCF520R5SLR40MG	52,00	40	309,8	261,8	1,84	G	TCF150512GP	TCF180508GC
5578759	TCF530R5SLR40MG	53,00	40	315,9	266,9	1,87	G	TCF150512GP	TCF180508GC
5578760	TCF540R5SLR40MG	54,00	40	321,9	271,9	1,89	G	TCF150512GP	TCF180508GC
5578761	TCF550R5SLR40MG	55,00	40	326,9	276,9	1,92	G	TCF150512GP	TCF180508GC
5578762	TCF560R5SLR40MG	56,00	40	332,9	281,9	1,94	G	TCF150512GP	TCF180508GC
5538659	TCF570R5SLR40MH	57,00	40	333,1	287,1	2,06	H	TCF180614HP	TCF210608HC
5538680	TCF580R5SLR40MH	58,00	40	339,1	292,1	2,09	H	TCF180614HP	TCF210608HC
5538681	TCF590R5SLR40MH	59,00	40	345,1	297,1	2,12	H	TCF180614HP	TCF210608HC
5538682	TCF600R5SLR40MH	60,00	40	350,1	302,1	2,15	H	TCF180614HP	TCF210608HC
5538683	TCF610R5SLR40MH	61,00	40	356,2	307,2	2,18	H	TCF180614HP	TCF210608HC
5538684	TCF620R5SLR40MH	62,00	40	362,2	312,2	2,20	H	TCF180614HP	TCF210608HC
5538685	TCF630R5SLR40MH	63,00	40	368,2	317,2	2,23	H	TCF180614HP	TCF210608HC
5538686	TCF640R5SLR40MH	64,00	40	373,3	322,3	2,26	H	TCF180614HP	TCF210608HC
5538687	TCF650R5SLR40MH	65,00	40	379,3	327,3	2,28	H	TCF180614HP	TCF210608HC
5538688	TCF660R5SLR40MH	66,00	40	385,3	332,3	2,31	H	TCF180614HP	TCF210608HC
5538689	TCF670R5SLR40MH	67,00	40	390,3	337,3	2,33	H	TCF180614HP	TCF210608HC
5538700	TCF680R5SLR40MH	68,00	40	396,4	342,4	2,36	H	TCF180614HP	TCF210608HC

NOTE: SSC = Pocket Seat Reference. To correspond with the SSC on the inserts.

## ▼ Spare Parts



SSC	periphery insert	centre insert	insert screw order number	Torx size	Torx driver order number	tightening torque Nm
A	TCF040204AP	TCF040203AC	2025073	T5	2029221	0,40
B	TCF050204BP	TCF060203BC	1175225	T6	1138455	0,53
C	TCF070306CP	TCF070304CC	1021337	T7	2029266	0,90
D	TCF080308DP	TCF090305DC	1134385	T8	2029598	1,10
E	TCF100408EP	TCF120405EC	2018194	T9	1138430	2,00
F	TCF120412FP	TCF150406FC	1756815	T15	1138455	4,00
F	TCF120412FP	TCF150406FC	1756815	T15	2029596	4,00
G	TCF150512GP	TCF180508GC	1099645	T20	1138455	6,30
H	TCF180614HP	TCF210608HC	1823871	T25	1022519	8,80
H	TCF180614HP	TCF210608HC	1823871	T25	1138455	8,80

NOTE: Drilling in stacked plates possible in certain applications. Ask for technical support.

Drill shipped with insert screws and Torx wrench.

See pages 60–63 for inserts.

SSC = Pocket Seat Reference.

SLR = Side Lock.

D	LS
20,00	50
25,00	56
32,00	60
40,00	70

**WARNING**

During through-hole operations, a slug or disc is produced as the tool breaks through the workpiece. When the drill is stationary and the workpiece is rotating, this slug may be hurled from the chuck by centrifugal force. Provide adequate shielding to protect bystanders.



# Top Cut 4™

Top Cut 4 Drill • Centre Inserts • Aluminium V36

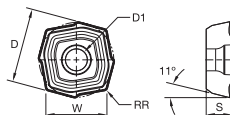

● first choice  
○ alternate choice

P	●	●	●	●
M	●	●	●	●
K	●	●	●	●
N	●	●	●	●
S	●	●	●	●
H	●	●	●	●

## ▼ Top Cut 4 Drill • Centre Inserts • Aluminium V36

catalogue number	D	D1	W	S	RR	SSC	WPK10CH	WU25CH	WU40PH	WN10PH
TCF040203ACV36	4,47	2,10	3,65	2,00	0,300	A	•	•	•	6407887
TCF060203BCV36	6,00	2,40	4,90	2,40	0,300	B	•	•	•	6372041
TCF070304CCV36	7,59	2,60	6,20	2,80	0,400	C	•	•	•	6372042
TCF090305DCV36	9,55	2,80	7,80	3,00	0,500	D	•	•	•	6372045
TCF120405ECV36	12,00	3,40	9,80	3,60	0,500	E	•	•	•	6372047
TCF150406FCV36	14,94	4,80	12,20	4,20	0,600	F	•	•	•	6346757
TCF180508GCV36	17,88	6,00	14,60	5,40	0,800	G	•	•	•	6407890
TCF210608HCV36	21,68	7,50	17,70	6,50	0,800	H	•	•	•	6372049

NOTE: SSC = Pocket Seat Reference. To correspond with the SSC on the toolholder.

# Top Cut 4™ Drill • Periphery Inserts • Aluminium V36

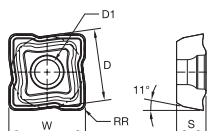

● first choice  
○ alternate choice

P	●	●	●	●
M	●	●	●	●
K	●	●	●	●
N	●	●	●	●
S	●	●	●	●
H	●	●	●	●

## ▼ Top Cut 4 Drill • Periphery Inserts • Aluminium V36

catalogue number	D	D1	W	S	RR	SSC	WPK10CH	WU25CH	WU40PH	WN10PH
TCF040204APV36	4,14	2,10	4,40	2,00	0,400	A	•	•	•	6407888
TCF050204BPV36	5,07	2,40	5,40	2,40	0,400	B	•	•	•	6371850
TCF070306CPV36	6,67	2,60	7,10	2,80	0,600	C	•	•	•	6372043
TCF080308DPV36	8,08	2,80	8,60	3,00	0,800	D	•	•	•	6372044
TCF100408EPV36	9,96	3,40	10,60	3,60	0,800	E	•	•	•	6372046
TCF120412FPV36	12,59	4,80	13,40	4,20	1,200	F	•	•	•	6348893
TCF150512GPV36	15,13	6,00	16,10	5,40	1,200	G	•	•	•	6407889
TCF180614HPV36	18,04	7,50	19,20	6,50	1,400	H	•	•	•	6372048

NOTE: SSC = Pocket Seat Reference. To correspond with the SSC on the toolholder.

# Top Cut 4™

Top Cut 4 Drill • Centre Inserts • Long Chip Materials V38

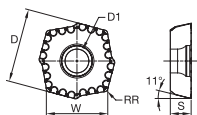

● first choice  
○ alternate choice

P	●	●	●
M	●	●	●
K	●	●	●
N	●	●	●
S	●	●	●
H	●	●	●

## ▼ Top Cut 4 Drill • Centre Inserts • Long Chip Materials V38

catalogue number	D	D1	W	S	RR	SSC	WPK10CH	WU25CH	WU40PH
TCF040203ACV38	4,47	2,10	3,65	2,00	0,300	A			6429458
TCF060203BCV38	6,00	2,40	4,90	2,40	0,300	B			6429459
TCF070304CCV38	7,59	2,60	6,20	2,80	0,400	C			6429460
TCF090305DCV38	9,55	2,80	7,80	3,00	0,500	D			6429461
TCF120405ECV38	12,00	3,40	9,80	3,60	0,500	E			6429462
TCF150406FCV38	14,94	4,80	12,20	4,20	0,600	F			6429463
TCF180508GCV38	17,88	6,00	14,60	5,40	0,800	G			6324383
TCF210608HCV38	21,68	7,50	17,70	6,50	0,800	H			6429464

NOTE: SSC = Pocket Seat Reference. To correspond with the SSC on the toolholder.  
Refer to the WIDIA™ 2017 Master Catalogue (A-15-04580EN\_me) or the NOVO™ application for the complete geometry offering.

# Top Cut 4™ Drill • Periphery Inserts • Long Chip Materials V38

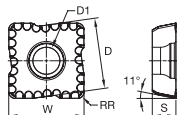

● first choice  
○ alternate choice

P	●	●	●
M	●	●	●
K	●	●	●
N	●	●	●
S	●	●	●
H	●	●	●

## ▼ Top Cut 4 Drill • Periphery Inserts • Long Chip Materials V38

catalogue number	D	D1	W	S	RR	SSC	WPK10CH	WU25CH	WU40PH
TCF040204APV38	4,14	2,10	4,40	2,00	0,400	A	6429424	6429425	
TCF050204BPV38	5,07	2,40	5,40	2,40	0,400	B	6429426	6429427	
TCF070306CPV38	6,67	2,60	7,10	2,80	0,600	C	6429466	6429428	
TCF080308DPV38	8,08	2,80	8,60	3,00	0,800	D	6429429	6429430	
TCF100408EPV38	9,96	3,40	10,60	3,60	0,800	E	6429451	6429452	
TCF120412FPV38	12,59	4,80	13,40	4,20	1,200	F	6429453	6429454	
TCF150512GPV38	15,13	6,00	16,10	5,40	1,200	G	6429455	6324381	
TCF180614HPV38	18,04	7,50	19,20	6,50	1,400	H	6429456	6429457	

NOTE: SSC = Pocket Seat Reference. To correspond with the SSC on the toolholder.  
Refer to the WIDIA™ 2017 Master Catalogue (A-15-04580EN\_me) or the NOVO™ application for the complete geometry offering.



# Top Cut 4™

## New Generation Indexable Drilling System

### ▼ Top Cut 4 • Insert Selection Guide

Material Group	Geometry	Stable Cutting Conditions		Unstable Cutting Conditions		Interrupted Cutting Conditions	
		periphery insert	centre insert	periphery insert	centre insert	periphery insert	centre insert
P1	V38	WU25CH	WU40PH	WU40PH	WU40PH	WU40PH	WU40PH
P2-P4	V34	WPK10CH	WU40PH	WU25CH	WU40PH	WU40PH	WU40PH
P5-P6	V36	WU25CH	WU40PH	WU40PH	WU40PH	WU40PH	WU40PH
M1-M3	V36	WU25CH	WU40PH	WU40PH	WU40PH	WU40PH	WU40PH
K1-K3	V34	WPK10CH	WU40PH	WU40PH	WU40PH	WU40PH	WU40PH
N1-N4	V36	WN10PH	WN10PH	WN10PH	WN10PH	WN10PH	WN10PH
S1-S4	V38	WU40PH	WU40PH	WU40PH	WU40PH	WU40PH	WU40PH

### ▼ Top Cut 4 • Cutting Data • Metric

Material Group	Geometry	Grade		Cutting Speed – Vc m/min			Metric				
							Recommended Feed Rate per Revolution				
							Tool Diameter	12,00–13,99 Insert Size A	14,00–18,99 Insert Size B	19,00–23,99 Insert Size C	24,00–29,99 Insert Size D
P0	-V38	WU40PH	WU25CH	120	180	260	mm/rev	0,06–0,08	0,08–0,11	0,10–0,13	0,11–0,14
P1	-V38	WU40PH	WU25CH	120	180	260	mm/rev	0,06–0,10	0,08–0,13	0,10–0,15	0,11–0,16
P2	-V34	WU40PH	WU25CH	120	190	280	mm/rev	0,06–0,10	0,08–0,15	0,10–0,16	0,11–0,17
P3	-V34	WU40PH	WPK10CH	120	200	310	mm/rev	0,08–0,15	0,10–0,16	0,11–0,18	0,12–0,20
P4	-V34	WU40PH	WPK10CH	120	190	310	mm/rev	0,08–0,15	0,10–0,16	0,11–0,18	0,12–0,20
P5	-V36	WU40PH	WU25CH	120	180	250	mm/rev	0,06–0,10	0,08–0,14	0,10–0,15	0,11–0,16
P6	-V36	WU40PH	WU25CH	120	160	210	mm/rev	0,06–0,10	0,08–0,14	0,10–0,15	0,11–0,16
M1	-V38	WU40PH	WU40PH	120	160	240	mm/rev	0,06–0,11	0,07–0,11	0,08–0,12	0,10–0,14
M2	-V38	WU40PH	WU40PH	110	140	210	mm/rev	0,06–0,10	0,07–0,11	0,08–0,12	0,10–0,14
M3	-V36	WU40PH	WU40PH	100	120	200	mm/rev	0,06–0,10	0,07–0,11	0,08–0,12	0,10–0,14
K1	-V34	WU25CH	WPK10CH	120	200	280	mm/rev	0,08–0,14	0,08–0,16	0,10–0,18	0,12–0,24
K2	-V34	WU40PH	WPK10CH	100	180	260	mm/rev	0,08–0,14	0,08–0,16	0,10–0,18	0,12–0,24
K3	-V34	WU40PH	WPK10CH	100	170	240	mm/rev	0,08–0,14	0,08–0,16	0,10–0,18	0,12–0,24
N1	-V36	WN10PH	WN10PH	250	350	500	mm/rev	0,06–0,10	0,08–0,14	0,10–0,15	0,11–0,16
N2	-V36	WN10PH	WN10PH	150	300	450	mm/rev	0,06–0,10	0,08–0,14	0,10–0,15	0,11–0,16
N3	-V36	WN10PH	WN10PH	80	120	150	mm/rev	0,06–0,10	0,07–0,11	0,08–0,12	0,10–0,14
S3	-V38	WU40PH	WU40PH	20	30	45	mm/rev	0,08–0,12	0,08–0,13	0,10–0,15	0,12–0,19
S4	-V38	WU40PH	WU40PH	35	40	65	mm/rev	0,08–0,12	0,08–0,13	0,10–0,15	0,12–0,19

Material Group	Geometry	Grade		Cutting Speed – Vc m/min			Metric				
							Recommended Feed Rate per Revolution				
							Tool Diameter	30,00–36,99 Insert Size E	37,00–45,99 Insert Size F	46,00–56,99 Insert Size G	57,00–68,00 Insert Size H
P0	-V38	WU40PH	WU25CH	120	180	260	mm/rev	0,13–0,16	0,15–0,18	0,16–0,23	0,17–0,24
P1	-V38	WU40PH	WU25CH	120	180	260	mm/rev	0,13–0,17	0,15–0,19	0,16–0,24	0,17–0,25
P2	-V34	WU40PH	WU25CH	120	190	280	mm/rev	0,13–0,20	0,15–0,21	0,16–0,28	0,17–0,30
P3	-V34	WU40PH	WPK10CH	120	200	310	mm/rev	0,16–0,24	0,16–0,24	0,18–0,30	0,19–0,32
P4	-V34	WU40PH	WPK10CH	120	190	310	mm/rev	0,14–0,22	0,16–0,24	0,18–0,30	0,19–0,32
P5	-V36	WU40PH	WU25CH	120	180	250	mm/rev	0,13–0,18	0,15–0,20	0,16–0,28	0,17–0,30
P6	-V36	WU40PH	WU25CH	120	160	210	mm/rev	0,13–0,18	0,15–0,20	0,16–0,28	0,17–0,30
M1	-V38	WU40PH	WU40PH	120	160	240	mm/rev	0,12–0,17	0,14–0,21	0,16–0,23	0,16–0,24
M2	-V38	WU40PH	WU40PH	110	140	210	mm/rev	0,12–0,17	0,14–0,21	0,16–0,23	0,16–0,24
M3	-V36	WU40PH	WU40PH	100	120	200	mm/rev	0,12–0,17	0,14–0,21	0,16–0,23	0,16–0,24
K1	-V34	WU25CH	WPK10CH	120	200	280	mm/rev	0,14–0,26	0,16–0,30	0,18–0,32	0,20–0,36
K2	-V34	WU40PH	WPK10CH	100	180	260	mm/rev	0,14–0,26	0,16–0,30	0,18–0,32	0,20–0,36
K3	-V34	WU40PH	WPK10CH	100	170	240	mm/rev	0,14–0,26	0,16–0,30	0,18–0,32	0,20–0,36
N1	-V36	WN10PH	WN10PH	250	350	500	mm/rev	0,13–0,18	0,15–0,20	0,16–0,28	0,17–0,30
N2	-V36	WN10PH	WN10PH	150	300	450	mm/rev	0,13–0,18	0,15–0,20	0,16–0,28	0,17–0,30
N3	-V36	WN10PH	WN10PH	80	120	150	mm/rev	0,12–0,17	0,14–0,21	0,16–0,23	0,16–0,24
S3	-V38	WU40PH	WU40PH	20	30	45	mm/rev	0,14–0,21	0,16–0,24	0,18–0,26	0,20–0,30
S4	-V38	WU40PH	WU40PH	35	40	65	mm/rev	0,14–0,21	0,16–0,24	0,18–0,26	0,20–0,30

NOTE: All speed conditions are for stable conditions. For unstable conditions, it is suggested to reduce starting speeds by 10%. For interrupted cuts, reduce by 20%.  
 For 4 x D, it is highly recommended to start with feed and speed values reduced by 10% less than above data.  
 For 5 x D, diameter range 12–23,99mm (insert sizes A to C), it is highly recommended to start with feed and speed values reduced by 20% less than above data.  
 For 5 x D, diameter range 25–68mm (inserts sizes D to H), it is highly recommended to start with feed and speed values reduced by 15% less than above data.  
 For 4 x D and 5 x D, it is recommended to reduce feed rate during entry and exit by 30–50%.

## New Generation Indexable Drilling System

## ▼ Top Cut 4™ • Drill Depth • X-Offset Capabilities • Hole Tolerance

Insert size	Diameter range mm	2 x D/3 x D			4 x D			5 x D		
		X-offset value max. in mm	D1 max value mm	Hole tolerance mm	X-offset value max. in mm	D1 max value mm	Hole tolerance mm	X-offset value max. in mm	D1 max value mm	Hole tolerance mm
A	12,00–13,99	0,5	D1 + 1mm	+/- 0,20	0,5	D1 + 1mm	+/- 0,35	—	—	+/- 0,35
B	14,00–18,99	0,5	D1 + 1mm	+/- 0,20	0,5	D1 + 1mm	+/- 0,35	—	—	+/- 0,35
C	19,00–23,99	0,5	D1 + 1mm	+/- 0,20	0,5	D1 + 1mm	+/- 0,35	—	—	+/- 0,35
D	24,00–29,99	0,8	D1 + 1,6mm	+/- 0,20	0,8	D1 + 1mm	+/- 0,35	—	—	+/- 0,35
E	30,00–36,99	0,8	D1 + 1,6mm	+/- 0,20	0,8	D1 + 1mm	+/- 0,35	—	—	+/- 0,35
F	37,00–45,99	0,8	D1 + 1,6mm	+/- 0,25	0,8	D1 + 1mm	+/- 0,38	—	—	+/- 0,38
G	46,00–56,99	1	D1 + 2mm	+/- 0,25	0,8	D1 + 1mm	+/- 0,38	—	—	+/- 0,38
H	57,00–68,00	1	D1 + 2mm	+/- 0,28	0,8	D1 + 1mm	+/- 0,42	—	—	+/- 0,42

# Top Cut 4™

New Generation Indexable Drilling System

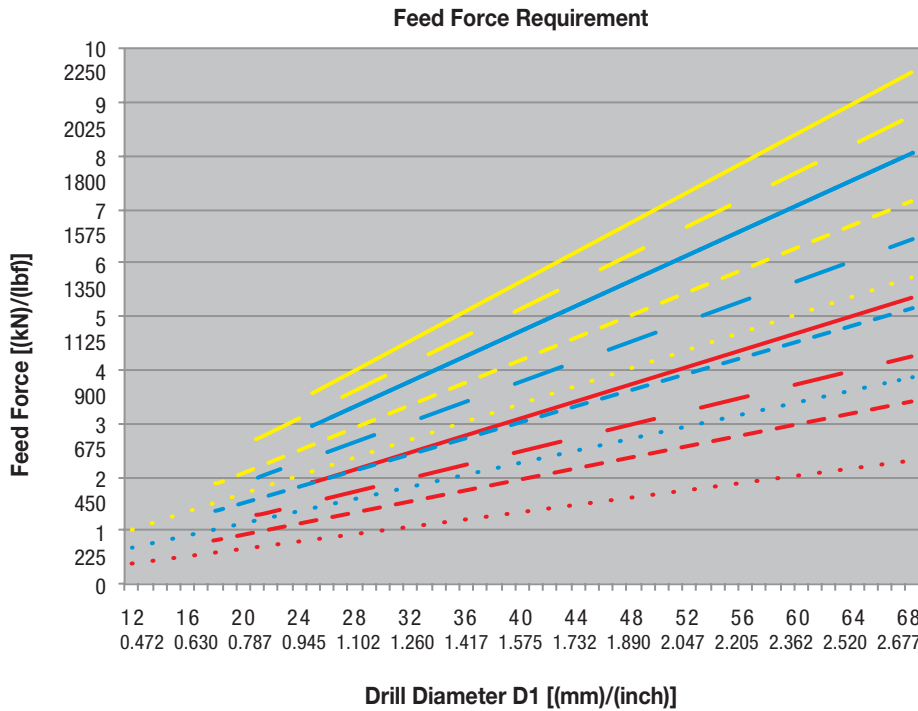

Stainless Steel 304	
— (Yellow)	f = 0.20 .0079 IPR
- - - (Yellow)	f = 0.18 .0071 IPR
- - - (Yellow)	f = 0.15 .0059 IPR
••••• (Yellow)	f = 0.12 .0047 IPR
Steel 4140	
— (Blue)	f = 0.25 .0098 IPR
- - - (Blue)	f = 0.20 .0079 IPR
- - - (Blue)	f = 0.16 .0063 IPR
••••• (Blue)	f = 0.12 .0047 IPR
Cast Iron GG25	
— (Red)	f = 0.25 .0098 IPR
- - - (Red)	f = 0.20 .0079 IPR
- - - (Red)	f = 0.16 .0059 IPR
••••• (Red)	f = 0.12 .0047 IPR

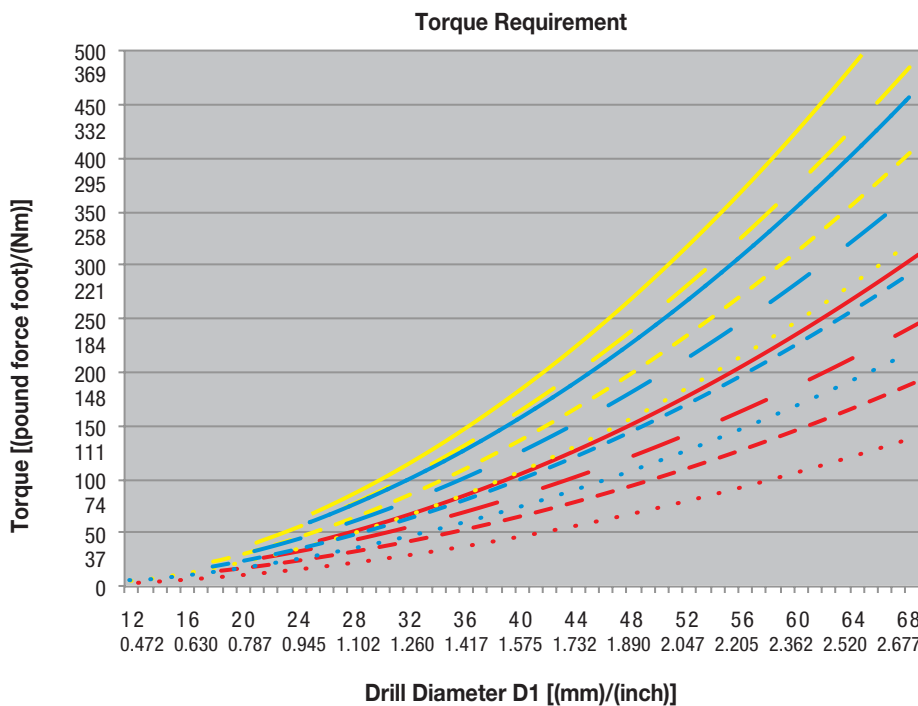

Stainless Steel 304	
— (Yellow)	f = 0.20 .0079 IPR
- - - (Yellow)	f = 0.18 .0071 IPR
- - - (Yellow)	f = 0.15 .0059 IPR
••••• (Yellow)	f = 0.12 .0047 IPR
Steel 4140	
— (Blue)	f = 0.25 .0098 IPR
- - - (Blue)	f = 0.20 .0079 IPR
- - - (Blue)	f = 0.16 .0059 IPR
••••• (Blue)	f = 0.12 .0047 IPR
Cast Iron GG25	
— (Red)	f = 0.25 .0098 IPR
- - - (Red)	f = 0.20 .0079 IPR
- - - (Red)	f = 0.16 .0059 IPR
••••• (Red)	f = 0.12 .0047 IPR

# New Generation Indexable Drilling System

**Power Requirement – Steel**

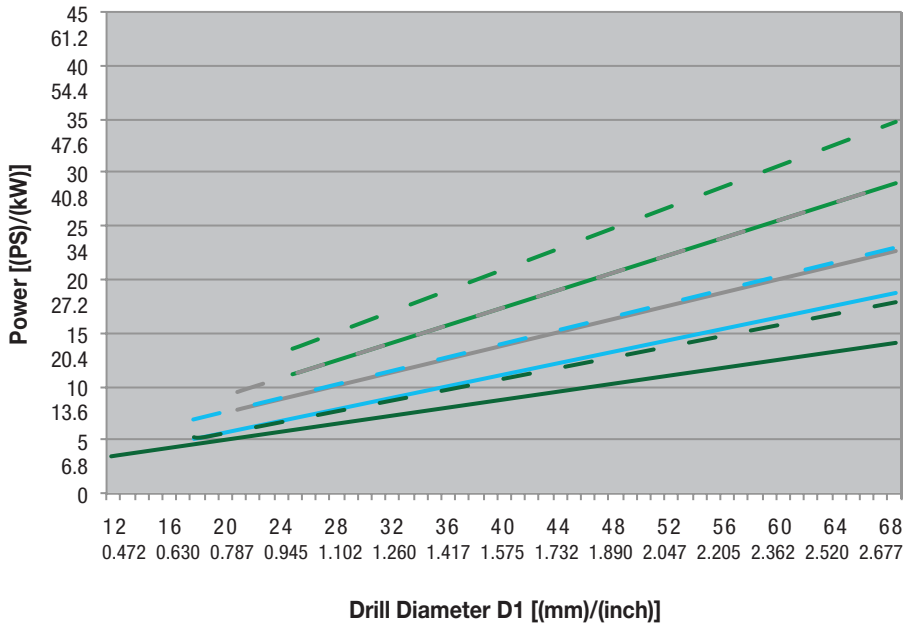

**Steel 4140**

- f = 0.25 (160 m/min)  
f = .0098  
IPR (525 SFM)
- - f = 0.25 (200 m/min)  
f = .0098  
IPR (656 SFM)
- f = 0.16 (160 m/min)  
f = .0063  
IPR (525 SFM)
- - f = 0.16 (200 m/min)  
f = .0063  
IPR (656 SFM)
- f = 0.12 (160 m/min)  
f = .0047  
IPR (525 SFM)
- - f = 0.12 (200 m/min)  
f = .0047  
IPR (656 SFM)
- f = 0.20 (160 m/min)  
f = .0079  
IPR (525 SFM)
- - f = 0.20 (200 m/min)  
f = .0079  
IPR (656 SFM)

**Power Requirement – Stainless Steel**

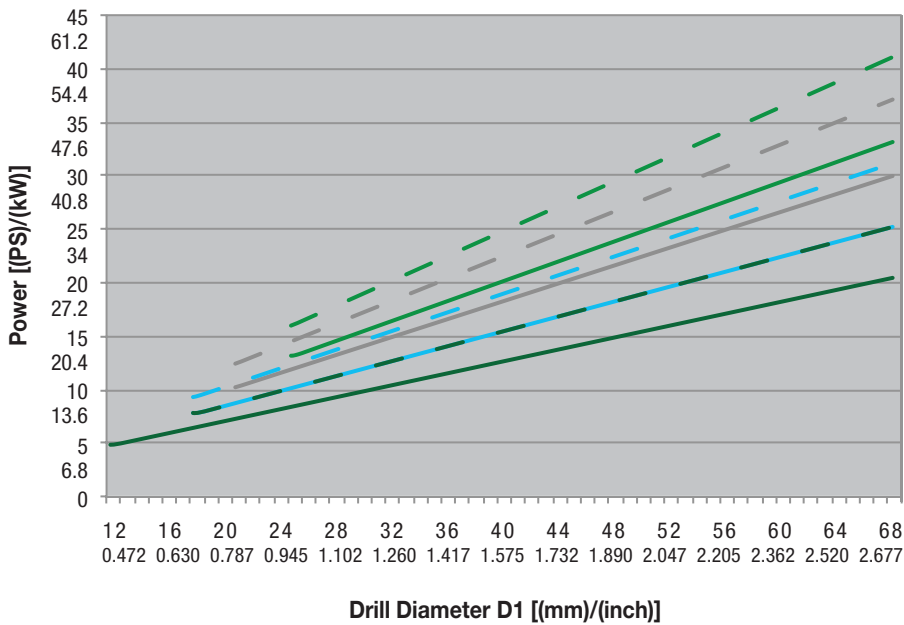

**Stainless Steel 304**

- f = 0.20 (160 m/min)  
f = .0079  
IPR (525 SFM)
- - f = 0.20 (200 m/min)  
f = .0079  
IPR (656 SFM)
- f = 0.15 (160 m/min)  
f = .0059  
IPR (525 SFM)
- - f = 0.15 (200 m/min)  
f = .0059  
IPR (656 SFM)
- f = 0.12 (160 m/min)  
f = .0047  
IPR (525 SFM)
- - f = 0.12 (200 m/min)  
f = .0047  
IPR (656 SFM)
- f = 0.18 (160 m/min)  
f = .0071  
IPR (525 SFM)
- - f = 0.18 (200 m/min)  
f = .0071  
IPR (656 SFM)

(continued)



# Top Cut 4™

New Generation Indexable Drilling System

(continued)

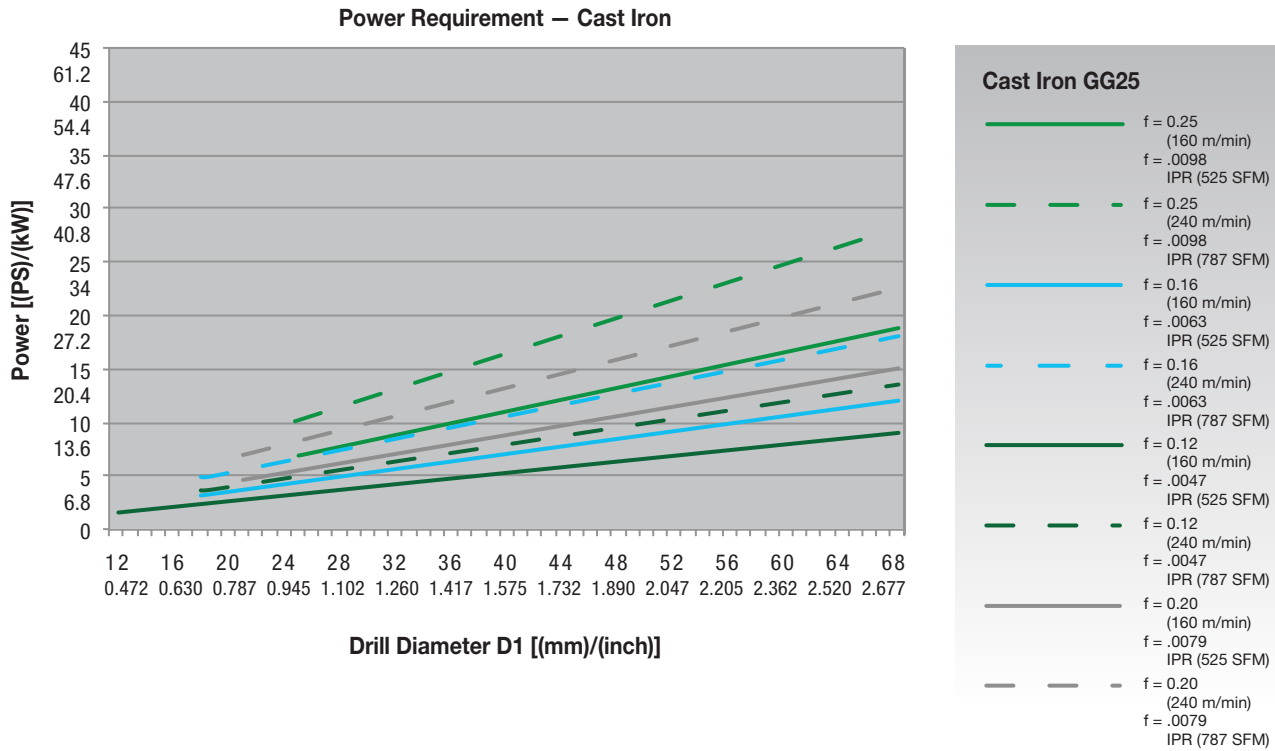

# Designed to Make Your Workplace More Productive

## WIDIA™ X-Feed™

WIDIA-branded X-Feed tooling was created as an application-specific portfolio to remove as much material as possible in the shortest amount of time, using a shallow depth of cut to achieve higher MRR and boost productivity.



FEED

HIGH-FEED MILLING

BOOST PRODUCTIVITY



### Victory™ X-Feed For Machining Stainless Steel and Titanium

#### 70NS Series

Designed for circular plunging and ramping, 3D machining, face milling, and pocketing applications.



### Victory X-Feed To Speed Up High-Feed Machining

#### VXF™ -7 and VXF™ -12 Series

VXF is a high-feed productivity booster designed to establish new industry standards with market-leading milling grades like WS40PM.

# WGC

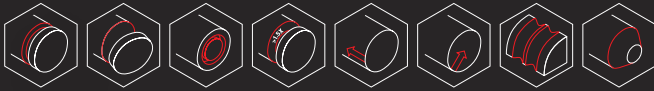

THE MOST VERSATILE TOOL ON THE MARKET IN GROOVING, PROFILING, AND CUT-OFF OPERATIONS

## 4 BENEFITS IN 1

### VERSATILE

GROOVING, PROFILING,  
AND CUT-OFF OPERATIONS

### SIMPLE

EASY TO SELECT  
AND APPLY

### STABLE

TRIPLE-V SEATING FOR  
SECURE CLAMPING

### PRODUCTIVE

LOW CUTTING FORCES IN  
THROUGH COOLANT FOR  
BETTER CHIP EVACUATION





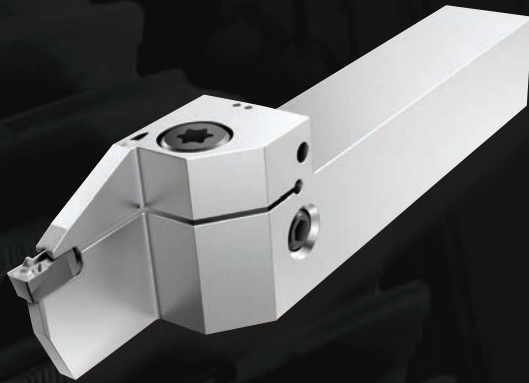

## Grooving

First choice for external grooving applications in most workpiece materials.

Through coolant capability and efficient coolant delivery for enhanced productivity.

Available in integral and modular style toolholders.

**Groove width:** 2–10mm.



## Cut-Off

Specially engineered chipbreakers for effective parting/cut-off and deep grooving.

Positive geometry for lower forces.

Secure seating offers greatest stability.

**Groove width:** 1,4–8mm.



## Profiling

Full radius chipbreaker for multi-directional turning and generating complex profiles.

Rigid design ensures smooth surface finish.

**Groove width:** 3–8mm.

**WIDIA** 

widia.com



# WGC

## Grooving, Cut-Off, and Profiling

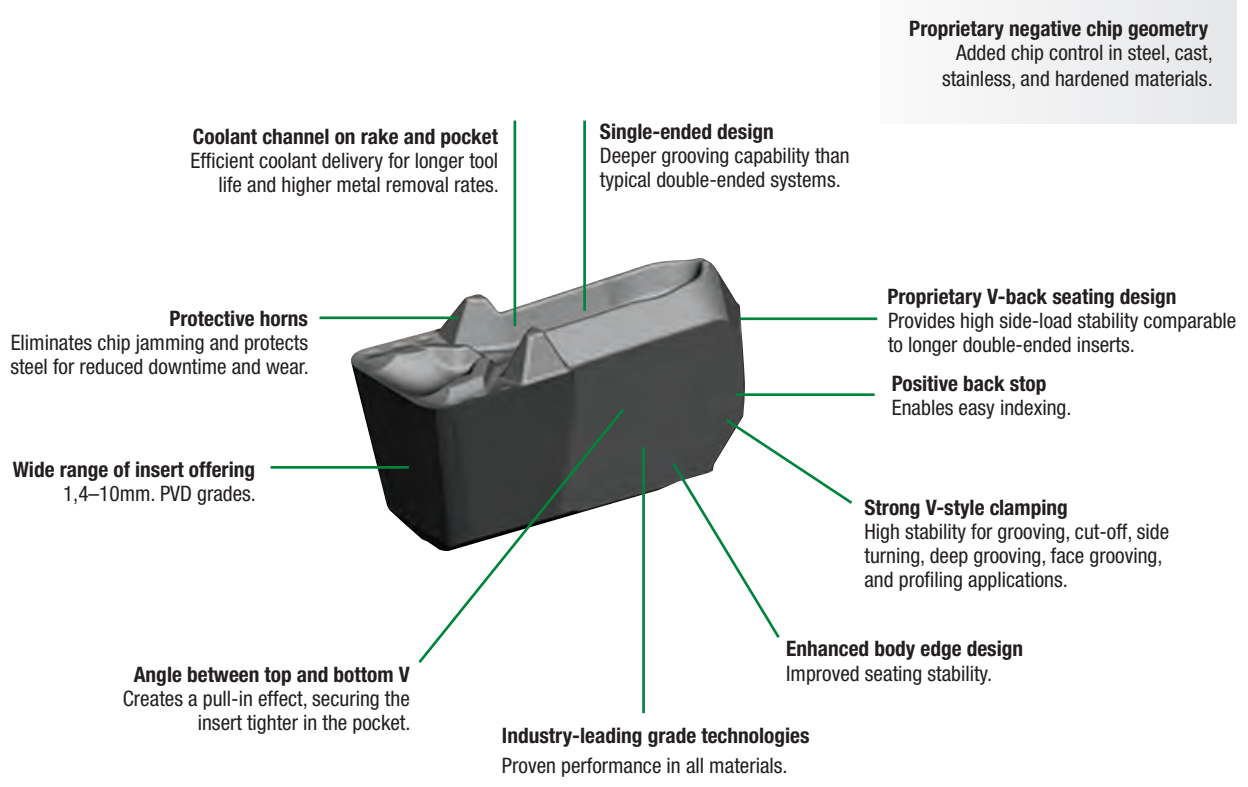

### Grooving Precision Moulded

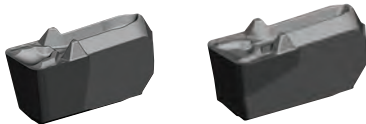

**P M N S**

PT-Positive Rake

**P M K H**

PN-Negative Rake

### Cut-Off Precision Moulded



**P M N S**

F-Fine

**P K**

M-Medium

**P M**

R-Rough

### Profiling Precision Moulded



**P M N S**

PR-Full Radius

NOTE: Use the NOVO™ software to select appropriate toolholder and insert.

## Our Solution to CPC Reduction

**K** Cast Iron

Holder: WGC-WG0612M06U08PN WU25PT  
Grade: WU10PT  
Diameter (ØT): 28mm  
No. of Edges: 1 (2 for competition)



Specifications	Competitor	WIDIA WGC
Cutting Diameter	28	28
Cutting Edges	2	1
Grade	P10	WU25PT
Cutting Speed (Vc)	125	125
Spindle Speed (n)	1421	1421
Feed (mm/rev)	0.1	0.1
Cutting Depth (ap)	4	4
Turning Length (l)	17	17
Total Time/Piece	0.12	0.12
Pieces/Edge	100	125
Life/Edge (min)	11.96	14.95
MRR (cm <sup>3</sup> /min/in <sup>3</sup> /min)	50	50



# WGC Integral Toolholders

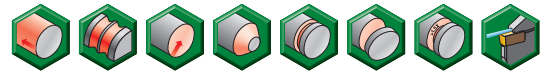

## ▼ Integral Straight • Metric

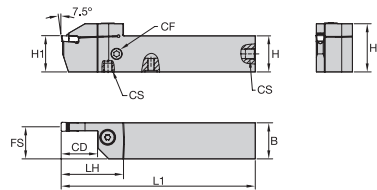

order number	catalogue number	SSC	CD	H1	H	B	H2	L1	FS	LH	CF	CS	Torx clamp screw	Torx clamp screw	Torx
<b>right hand</b>															
6461946	WGCSMR2020K0216	2	16	20	20	20	27	125	19	31	—	—	—	MS1160	T20
6461948	WGCSMR2525M0216	2	16	25	25	25	32	150	24	31	—	—	—	MS1160	T20
6461950	WGCSMR2020K0222	2	22	20	20	20	29	125	19	38	—	—	MS2091	—	25 IP
6461952	WGCSMR2525M0226	2	26	25	25	25	34	150	24	42	—	—	MS2091	—	25 IP
6462003	WGCSMR2020K0316C	3	16	20	20	20	29	125	19	37	M8X1	M8X1	MS1595	—	T30
6462004	WGCSMR2525M0316C	3	16	25	25	25	34	150	24	37	G1/8-28	G1/8-28	MS1595	—	T30
6462005	WGCSMR2020K0322C	3	22	20	20	20	30	125	19	43	M8X1	M8X1	MS1595	—	T30
6462006	WGCSMR2525M0326C	3	26	25	25	25	35	150	24	47	G1/8-28	G1/8-28	MS1595	—	T30
6462007	WGCSMR2020K0416C	4	16	20	20	20	29	125	18	37	M8X1	M8X1	MS1595	—	T30
6462008	WGCSMR2525M0416C	4	16	25	25	25	34	150	23	37	G1/8-28	G1/8-28	MS1595	—	T30
6462009	WGCSMR2020K0422C	4	22	20	20	20	30	125	18	43	M8X1	M8X1	MS1595	—	T30
6462010	WGCSMR2525M0426C	4	26	25	25	25	35	150	23	47	G1/8-28	G1/8-28	MS1595	—	T30
6462061	WGCSMR3232P0426C	4	26	32	32	32	42	170	30	47	G1/8-28	G1/8-28	MS1970	—	T30
6462062	WGCSMR3232P0432C	4	32	32	32	32	42	170	30	53	G1/8-28	G1/8-28	MS1970	—	T30
6462063	WGCSMR2525M0516C	5	16	25	25	25	34	150	23	37	G1/8-28	G1/8-28	MS1970	—	T30
6462064	WGCSMR2525M0526C	5	26	25	25	25	35	150	23	47	G1/8-28	G1/8-28	MS1970	—	T30
6462065	WGCSMR3232P0526C	5	26	32	32	32	42	170	30	47	G1/8-28	G1/8-28	MS1970	—	T30
6462066	WGCSMR3232P0532C	5	32	32	32	32	42	170	30	53	G1/8-28	G1/8-28	MS1970	—	T30
6462067	WGCSMR2525M0616C	6	16	25	25	25	34	150	22	37	G1/8-28	G1/8-28	MS1970	—	T30
6462068	WGCSMR2525M0626C	6	26	25	25	25	35	150	22	47	G1/8-28	G1/8-28	MS1970	—	T30
6462069	WGCSMR3232P0626C	6	26	32	32	32	42	170	29	47	G1/8-28	G1/8-28	MS1970	—	T30
6462070	WGCSMR3232P0632C	6	32	32	32	32	44	170	29	55	G1/8-28	G1/8-28	MS1490	—	T45
6462071	WGCSMR4040R0640C	6	40	40	40	40	52	200	37	63	G1/8-28	G1/8-28	MS1490	—	T45
6462072	WGCSMR2525M0826C	8	26	25	25	25	36	150	21	49	G1/8-28	G1/8-28	MS1490	—	T45
6462073	WGCSMR3232P0826C	8	26	32	32	32	43	170	28	49	G1/8-28	G1/8-28	MS1490	—	T45
6462074	WGCSMR3232P0832C	8	32	32	32	32	44	170	28	55	G1/8-28	G1/8-28	MS1490	—	T45
6462075	WGCSMR4040R0840C	8	40	40	40	40	52	200	36	63	G1/8-28	G1/8-28	MS1490	—	T45
6462076	WGCSMR3232P1032C	10	32	32	32	32	44	170	28	55	G1/8-28	G1/8-28	MS1490	—	T45
6462077	WGCSMR4040R1040C	10	40	40	40	40	52	200	36	63	G1/8-28	G1/8-28	MS1490	—	T45
<b>left hand</b>															
6461954	WGCSML2020K0216	2	16	20	20	20	27	125	19	31	—	—	—	MS1160	T20
6461956	WGCSML2525M0216	2	16	25	25	25	32	150	24	31	—	—	—	MS1160	T20
6461958	WGCSML2020K0222	2	22	20	20	20	29	125	19	38	—	—	MS2091	—	25 IP
6461960	WGCSML2525M0226	2	26	25	25	25	34	150	24	42	—	—	MS2091	—	25 IP
6462078	WGCSML2020K0316C	3	16	20	20	20	29	125	19	37	M8X1	M8X1	MS1595	—	T30
6462079	WGCSML2525M0316C	3	16	25	25	25	34	150	24	37	G1/8-28	G1/8-28	MS1595	—	T30
6462080	WGCSML2020K0322C	3	22	20	20	20	30	125	19	43	M8X1	M8X1	MS1595	—	T30
6462091	WGCSML2525M0326C	3	26	25	25	25	35	150	24	47	G1/8-28	G1/8-28	MS1595	—	T30
6462092	WGCSML2020K0416C	4	16	20	20	20	29	125	18	37	M8X1	M8X1	MS1595	—	T30

(continued)

(Integral Straight • Metric – continued)

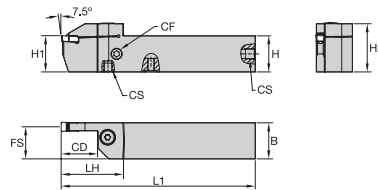
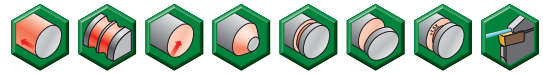

order number	catalogue number	SSC	CD	H1	H	B	H2	L1	FS	LH	CF	CS	Torx clamp screw	Torx clamp screw	Torx
6462093	WGCSML2525M0416C	4	16	25	25	25	34	150	23	37	G1/8-28	G1/8-28	MS1595	—	T30
6462094	WGCSML2020K0422C	4	22	20	20	20	30	125	18	43	M8X1	M8X1	MS1595	—	T30
6462095	WGCSML2525M0426C	4	26	25	25	25	35	150	23	47	G1/8-28	G1/8-28	MS1595	—	T30
6462096	WGCSML3232P0426C	4	26	32	32	32	42	170	30	47	G1/8-28	G1/8-28	MS1970	—	T30
6462097	WGCSML3232P0432C	4	32	32	32	32	42	170	30	53	G1/8-28	G1/8-28	MS1970	—	T30
6462098	WGCSML2525M0516C	5	16	25	25	25	34	150	23	37	G1/8-28	G1/8-28	MS1970	—	T30
6462099	WGCSML2525M0526C	5	26	25	25	25	35	150	23	47	G1/8-28	G1/8-28	MS1970	—	T30
6462100	WGCSML3232P0526C	5	26	32	32	32	42	170	30	47	G1/8-28	G1/8-28	MS1970	—	T30
6462101	WGCSML3232P0532C	5	32	32	32	32	42	170	30	53	G1/8-28	G1/8-28	MS1970	—	T30
6462102	WGCSML2525M0616C	6	16	25	25	25	34	150	22	37	G1/8-28	G1/8-28	MS1970	—	T30
6462103	WGCSML2525M0626C	6	26	25	25	25	35	150	22	47	G1/8-28	G1/8-28	MS1970	—	T30
6462104	WGCSML3232P0626C	6	26	32	32	32	42	170	29	47	G1/8-28	G1/8-28	MS1970	—	T30
6462105	WGCSML3232P0632C	6	32	32	32	32	44	170	29	55	G1/8-28	G1/8-28	MS1490	—	T45
6462106	WGCSML4040R0640C	6	40	40	40	40	52	200	37	63	G1/8-28	G1/8-28	MS1490	—	T45
6462107	WGCSML2525M0826C	8	26	25	25	25	36	150	21	49	G1/8-28	G1/8-28	MS1490	—	T45
6462108	WGCSML3232P0826C	8	26	32	32	32	43	170	28	49	G1/8-28	G1/8-28	MS1490	—	T45
6462109	WGCSML3232P0832C	8	32	32	32	32	44	170	28	55	G1/8-28	G1/8-28	MS1490	—	T45
6462110	WGCSML4040R0840C	8	40	40	40	40	52	200	36	63	G1/8-28	G1/8-28	MS1490	—	T45
6462111	WGCSML3232P1032C	10	32	32	32	32	44	170	28	55	G1/8-28	G1/8-28	MS1490	—	T45
6462112	WGCSML4040R1040C	10	40	40	40	40	52	200	36	63	G1/8-28	G1/8-28	MS1490	—	T45

NOTE: SSC = Pocket Seat Reference. To correspond with the SSC on the insert.

## WGC Modular Toolholders

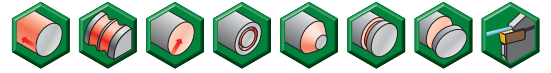

### ▼ WGCMS-C • Metric

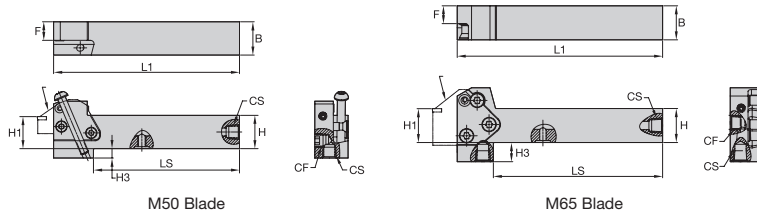

M50 Blade

M65 Blade



order number	catalogue number	B	H	H1	L1	F	CS	CF	LS	H3	blade size	blade screw	Torx	clamping screw	Torx
<b>right hand</b>															
6499222	WGCMR2525M50C	25	25	25	138,75	13,84	G 1/8-28	G 1/8-28	109,00	7,00	50	MS1162	T25	MS2002	T25
6499223	WGCMR2525M65C	25	25	25	150,00	13,00	G 1/8-28	G 1/8-28	122,00	—	65	MS1163	T30	—	—
6499224	WGCMR3232P50C	32	32	32	158,75	20,08	G 1/8-28	G 1/8-28	133,62	—	50	MS1162	T25	MS2002	T25
6499225	WGCMR3232P65C	32	32	32	170,00	20,00	G 1/8-28	G 1/8-28	142,00	21,75	65	MS1163	T30	—	—
<b>left hand</b>															
6499226	WGMSL2525M50C	25	25	25	138,75	13,84	G 1/8-28	G 1/8-28	109,00	7,00	50	MS1162	T25	MS2002	T25
6499227	WGMSL2525M65C	25	25	25	150,00	13,00	G 1/8-28	G 1/8-28	122,00	29,00	65	MS1163	T30	—	—
6499228	WGMSL3232P50C	32	32	32	158,75	20,08	G 1/8-28	G 1/8-28	133,62	—	50	MS1162	T25	MS2002	T25
6499229	WGMSL3232P65C	32	32	32	170,00	20,00	G 1/8-28	G 1/8-28	142,00	21,75	65	MS1163	T30	—	—

NOTE: WGCMS.: Right-hand holder uses right-hand blades.  
 WGCME.: Right-hand holder uses left-hand blades.  
 M50 blade and clamp screw torque equals 8–10 Nm (71–88 in. lbs.).  
 M65 blade and clamp screw torque equals 18–20 Nm (159–177 in. lbs.).



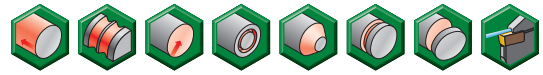

### ▼ WGCME-C • Metric

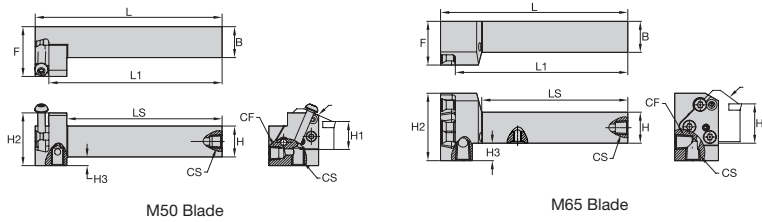

order number	catalogue number	B	H	H1	L	L1	LS	F	CS	CF	H2	H3	blade size	blade screw	Torx	clamping screw	Torx
<b>right hand</b>																	
6498953	WGCMER2525M65C	25	25	25	150,00	138,15	117,00	35,00	G 1/8-28	G 1/8-28	54,00	14,00	65	MS1163	T30	—	—
6498954	WGCMER2525M50C	25	25	25	150,25	139,25	125,25	40,00	G 1/8-28	G 1/8-28	42,41	7,00	50	MS1162	T25	MS2002	T25
6498955	WGCMER3232P65C	32	32	32	170,00	158,15	137,00	35,00	G 1/8-28	G 1/8-28	54,00	7,00	65	MS1163	T30	—	—
6498956	WGCMER3232P50C	32	32	32	170,25	159,25	145,25	40,00	G 1/8-28	G 1/8-28	42,41	—	50	MS1162	T25	MS2002	T25
<b>left hand</b>																	
6498957	WGCMEML2525M65C	25	25	25	150,00	138,15	117,00	35,00	G 1/8-28	G 1/8-28	54,00	14,00	65	MS1163	T30	—	—
6498958	WGCMEML2525M50C	25	25	25	150,25	139,25	125,25	40,00	G 1/8-28	G 1/8-28	42,41	7,00	50	MS1162	T25	MS2002	T25
6498959	WGCMEML3232P65C	32	32	32	170,00	158,15	137,00	35,00	G 1/8-28	G 1/8-28	54,00	7,00	65	MS1163	T30	—	—
6498960	WGCMEML3232P50C	32	32	32	170,25	159,25	145,25	40,00	G 1/8-28	G 1/8-28	42,41	—	50	MS1162	T25	MS2002	T25

NOTE: WGCMS.: Right-hand holder uses right-hand blades.  
 WGCME.: Right-hand holder uses left-hand blades.  
 M50 blade and clamp screw torque equals 8–10 Nm (71–88 in. lbs.).  
 M65 blade and clamp screw torque equals 18–20 Nm (159–177 in. lbs.).

# WGC Modular Blades

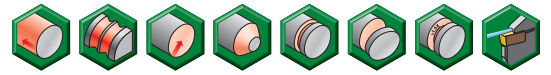

## ▼ Modular Straight Blade with Coolant

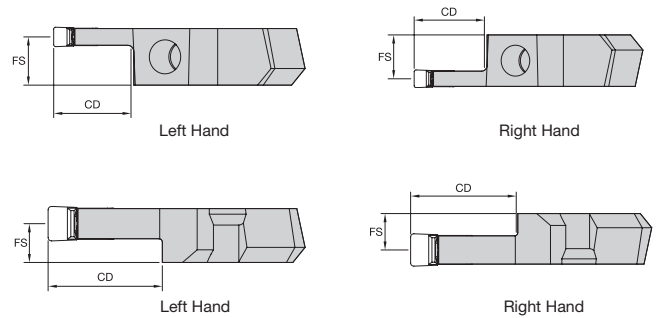

order number	catalogue number	SSC	CD	FS	blade size
<b>right hand</b>					
6498457	WGCM50R1F12M	1F	12,0	11,00	50
6498458	WGCM50R0212M	2	12,0	10,88	50
6498459	WGCM50R0216M	2	16,0	10,88	50
6498460	WGCM50R0312MC	3	12,0	10,43	50
6498861	WGCM50R0322MC	3	22,0	10,43	50
6498862	WGCM50R0412MC	4	12,0	9,93	50
6498863	WGCM50R0422MC	4	22,0	9,93	50
6498864	WGCM50R0432MC	4	32,0	9,93	50
6498865	WGCM50R0512MC	5	12,0	9,43	50
6498866	WGCM50R0516MC	5	16,0	9,43	50
6498867	WGCM50R0526MC	5	26,0	9,43	50
6498868	WGCM50R0532MC	5	32,0	9,43	50
6498869	WGCM65R0616MC	6	16,0	9,88	65
6498870	WGCM65R0626MC	6	26,0	9,88	65
6498881	WGCM65R0632MC	6	32,0	9,88	65
6498882	WGCM65R0816MC	8	16,0	9,00	65
6498883	WGCM65R0826MC	8	26,0	9,00	65
<b>left hand</b>					
6498884	WGCM50L1F12M	1F	12,0	11,00	50
6498885	WGCM50L0212M	2	12,0	10,88	50
6498886	WGCM50L0216M	2	16,0	10,88	50
6498887	WGCM50L0312MC	3	12,0	10,43	50
6498888	WGCM50L0322MC	3	22,0	10,43	50
6498889	WGCM50L0412MC	4	12,0	9,93	50
6498890	WGCM50L0422MC	4	22,0	9,93	50
6498891	WGCM50L0432MC	4	32,0	9,93	50
6498892	WGCM50L0512MC	5	12,0	9,43	50
6498893	WGCM50L0516MC	5	16,0	9,43	50
6498894	WGCM50L0526MC	5	26,0	9,43	50
6498895	WGCM50L0532MC	5	32,0	9,43	50
6498896	WGCM65L0616MC	6	16,0	9,88	65
6498897	WGCM65L0626MC	6	26,0	9,88	65
6498898	WGCM65L0632MC	6	32,0	9,88	65
6498899	WGCM65L0816MC	8	16,0	9,00	65
6498900	WGCM65L0826MC	8	26,0	9,00	65

NOTE: SSC = Pocket Seat Reference. To correspond with the SSC on the insert.  
Through the pocket coolant available in seat sizes 3 and higher.

### ▼ Blade Holders • Metric

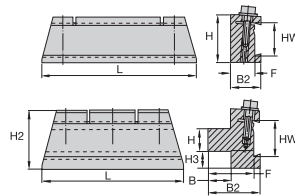

order number	catalogue number	HW	H	B	F	H2	B2	H3	L	cap screw	wrench
2007826	12251222000	26	20,0	18,0	33,0	40	38	8	100	12148036000	12148041300
2021635	12251222500	32	25,0	20,0	35,0	50	40	10	125	12148036000	12148041300
2008159	12251233200	53	32,0	25,0	50,0	82	57	30	160	12146013400	12148041400
2021723	12251234000	53	40,0	40,0	58,0	82	65	22	160	12146013400	12148041400

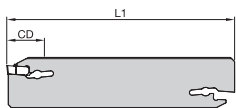

Straight

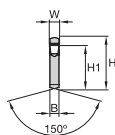

Reinforced

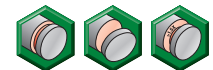
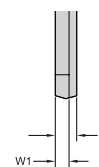
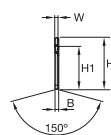
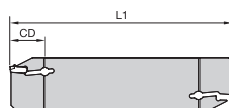

### ▼ Double-Ended Cut-Off Blade

order number	catalogue number	SSC	H	W	W1	H1	L1	B	CD	assembly wrench
<b>neutral hand</b>										
6498987	WGCBSN19G1B14	1B	19	1,4	1,15	15,5	90	1,80	14	SCW5E
6498988	WGCBSN26J1B15	1B	26	1,4	1,15	21,5	110	1,80	15	SCW5E
6498989	WGCBSN19G1F16	1F	19	1,6	1,30	15,5	90	1,80	16	SCW5E
6498990	WGCBSN26J1F17	1F	26	1,6	1,30	21,5	110	1,80	17	SCW5E
6499211	WGCBSN19G0220	2	19	2,0	—	15,5	90	1,65	—	SCW5E
6499212	WGCBSN26J0230	2	26	2,0	—	21,5	110	1,65	—	SCW5E
6499213	WGCBSN32M0250	2	32	2,0	—	25,1	150	1,65	—	SCW5E
6499215	WGCBSN32M0350	3	32	3,0	—	25,1	150	2,40	—	SCW5E
6499214	WGCBSN26J0340	3	36	3,0	—	21,5	110	2,40	—	SCW5E
6499216	WGCBSN26J0440	4	26	4,0	—	21,5	110	3,40	—	SCW5E
6499217	WGCBSN32M0450	4	32	4,0	—	25,1	150	3,40	—	SCW5E
6499218	WGCBSN32M0560	5	32	5,0	—	25,1	150	4,40	—	SCW5E
6499219	WGCBSN32M0660	6	32	6,0	—	25,1	150	5,40	—	SCW8E
6499220	WGCBSN32M0860	8	32	8,0	—	25,1	150	7,00	—	SCW8E
6499221	WGCBSN52X08120	8	53	8,0	—	45,3	260	7,00	—	SCW8E

NOTE: SSC = Pocket Seat Reference. To correspond with the SSC on the insert.

### ▼ Spare Parts

screw catalogue number	screw order number	torque				socket	wrench catalogue number	wrench order number
		Nm	in. lbs.	thread	socket			
MS1160	1099645	7	62	M5	T20	KT20	1022703	
MS1162	1127019	9	80	M6	T25	KT25	1022725	
MS1163	1124104	18	159	M8	T30	KT30L	1099676	
MS1273	1020977	4	35.4	M4	T15	KT15	1022701	
MS1490	2263299	17	151	M8	T45	KT45	1018227	
MS1595	1094300	12	106	M6	T30	KT30	1099676	
MS1970	1106668	12	106	M6	T30	KT30	1099676	
MS2002	1621087	9	80	M6	T25	KT25	1022725	
MS2091	1931147	9	80	M5	25IP	K25IP	2050113	

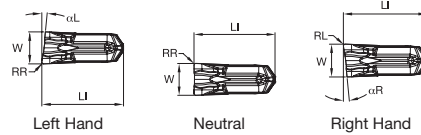

● first choice  
○ alternate choice

P	●
M	●
K	○
N	○
S	●
H	

▼ F Precision Moulded • Metric

catalogue number	SSC	W	W tol ±	LI	αR	αL	RR	RL	WU25PT
WC014M1BL06F01	1B	1,40	0,050	9,00	—	6	0,15	—	6470544
WC014M1BN00F01	1B	1,40	0,050	9,00	—	—	0,15	0,15	6470545
WC014M1BR06F01	1B	1,40	0,050	9,02	6	—	—	0,15	6470546
WC020M02L06F02	2	2,00	0,050	9,00	—	6	0,20	—	6470547
WC020M02N00F02	2	2,00	0,050	9,00	—	—	0,20	0,20	6470548
WC020M02R06F02	2	2,00	0,050	9,00	6	—	—	0,20	6470549
WC030M03L06F02	3	3,00	0,075	9,60	—	6	0,20	—	6470550
WC030M03N00F02	3	3,00	0,075	9,60	—	—	0,20	0,20	6470561
WC030M03R06F02	3	3,00	0,075	9,60	6	—	—	—	6470562
WC040M04L06F02	4	4,00	0,075	10,19	—	6	0,20	—	6470563
WC040M04N00F02	4	4,00	0,075	10,19	—	—	0,20	0,20	6470564
WC040M04R06F02	4	4,00	0,075	10,19	6	—	—	0,20	6470565
WC050M05N00F03	5	5,00	0,075	12,24	—	—	0,30	0,30	6470566

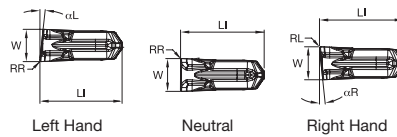

▼ M Precision Moulded • Metric

catalogue number	SSC	W	W tol ±	LI	αR	αL	RR	RL	WU25PT
WC014M1BL06M02	1B	1,40	0,050	9,02	—	6	—	0,20	6461828
WC014M1BN00M01	1B	1,40	0,050	9,01	—	—	0,15	0,15	6461829
WC014M1BR06M02	1B	1,40	0,050	9,02	6	—	—	0,20	6461830
WC020M02L06M02	2	2,00	0,050	8,97	—	6	—	0,20	6461861
WC020M02N00M02	2	2,00	0,050	8,98	—	—	0,20	0,20	6461862
WC020M02R06M02	2	2,00	0,050	9,00	6	—	—	0,20	6461863
WC030M03L06M02	3	3,00	0,075	9,61	—	6	—	0,20	6461864
WC030M03N00M02	3	3,00	0,075	9,60	—	—	0,20	0,20	6461865
WC030M03R06M02	3	3,00	0,075	9,61	6	—	—	0,20	6461866
WC040M04L06M02	4	4,00	0,075	10,19	—	6	0,20	—	6461867
WC040M04N00M02	4	4,00	0,075	10,20	—	—	0,20	0,20	6461868
WC040M04R06M02	4	4,00	0,050	10,20	6	—	—	0,20	6461869
WC050M05N00M03	5	5,00	0,075	12,25	—	—	0,30	0,30	6461870
WC060M06N00M03	6	6,00	0,075	14,59	—	—	0,30	0,30	6461881
WC080M08N00M04	8	8,00	0,075	17,46	—	—	0,40	0,40	6461882

NOTE: SSC = Pocket Seat Reference. To correspond with the SSC on the toolholder.



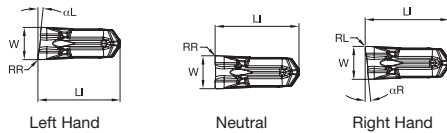

● first choice  
○ alternate choice

P	●
M	●
K	○
N	○
S	●
H	

### ▼ R Precision Moulded • Metric

catalogue number	SSC	W	W tol ±	LI	αR	αL	RR	RL	WU25PT
WC020M02L06R02	2	2,00	0,050	8,97	—	6	0,20	—	6470426
WC020M02N00R02	2	2,00	0,050	8,98	—	—	0,20	0,20	6470427
WC020M02R06R02	2	2,00	0,050	8,97	6	—	—	0,20	6470428
WC030M03L06R02	3	3,00	0,075	9,61	—	6	0,20	—	6470429
WC030M03N00R02	3	3,00	0,075	9,60	—	—	0,20	0,20	6470430
WC030M03R06R02	3	3,00	0,075	9,61	6	—	—	0,20	6470461
WC040M04N00R02	4	4,00	0,075	10,20	—	—	0,20	0,20	6470462
WC050M05N00R03	5	5,00	0,075	12,25	—	—	0,30	0,30	6470463
WC060M06N00R03	6	6,00	0,075	14,59	—	—	0,30	0,30	6470464
WC080M08N00R04	8	8,00	0,075	17,46	—	—	0,40	0,40	6470465

NOTE: SSC = Pocket Seat Reference. To correspond with the SSC on the toolholder.



P M K N S

### WU25PT™

Advanced Universal Grade with Hard PVD AlTiN Coating and Fine-Grain Substrate

This new and improved coating improves edge stability with wide range speed and feed capabilities.

The WU25PT grade is ideal for general machining of most steels, stainless steels, high-temp alloys, titanium, irons, and non-ferrous materials in a wide range of speeds and feeds with improved edge toughness for interrupted cuts and high feed rates.

For more information, visit [widia.com](http://widia.com).

# WGC Grooving Inserts

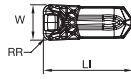

● first choice  
○ alternate choice

P	●
M	●
K	○
N	○
S	●
H	

## ▼ PT Precision Moulded • Metric

catalogue number	SSC	W	W tol ±	RR	LI	WU25PT
WG0212M02U02PT	2	2,13	0,050	0,20	8,97	6461734
WG0251M02U02PT	2	2,51	0,050	0,20	8,97	6461735
WG0312M03U02PT	3	3,13	0,075	0,20	9,60	6461736
WG0312M03U04PT	3	3,13	0,075	0,40	9,60	6461737
WG0412M04U04PT	4	4,13	0,075	0,40	10,19	6461738
WG0412M04U08PT	4	4,13	0,075	0,80	10,19	6461739
WG0512M05U04PT	5	5,13	0,075	0,40	12,25	6461740
WG0512M05U08PT	5	5,13	0,075	0,80	12,25	6461821
WG0612M06U04PT	6	6,13	0,075	0,40	14,59	6461822
WG0612M06U08PT	6	6,13	0,075	0,80	14,59	6461823
WG0712M06U08PT	6	7,13	0,075	0,80	14,59	6461824
WG0812M08U08PT	8	8,13	0,075	0,80	17,45	6461825
WG0812M08U12PT	8	8,13	0,075	1,20	17,45	6461826
WG1012M10U12PT	10	10,13	0,075	1,20	20,75	6461827

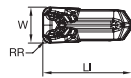

## ▼ PN Precision Moulded • Metric

catalogue number	SSC	W	W tol ±	RR	LI	WU25PT
WG0212M02U02PN	2	2,13	0,050	0,20	8,97	6470850
WG0251M02U02PN	2	2,51	0,050	0,20	8,97	6471041
WG0312M03U02PN	3	3,13	0,075	0,20	9,60	6471042
WG0312M03U04PN	3	3,13	0,075	0,40	9,60	6471043
WG0412M04U04PN	4	4,13	0,075	0,40	10,20	6471044
WG0412M04U08PN	4	4,13	0,075	0,80	10,20	6471045
WG0512M05U04PN	5	5,13	0,075	0,40	12,24	6471046
WG0512M05U08PN	5	5,13	0,075	0,80	12,24	6471047
WG0612M06U04PN	6	6,13	0,075	0,40	14,59	6471048
WG0612M06U08PN	6	6,13	0,075	0,80	14,59	6471049
WG0812M08U08PN	8	8,13	0,075	0,80	17,46	6471050
WG0812M08U12PN	8	8,13	0,075	1,20	17,46	6471062
WG1012M10U12PN	10	10,13	0,075	1,20	20,75	6471064

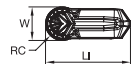

## ▼ PR Full Radius Precision Ground • Metric

catalogue number	SSC	W	W tol ±	RC	LI	WU25PT
WR0200M02P00PC	2	2,00	0,025	1,00	8,91	6470467
WR0300M03P00PC	3	3,00	0,025	1,50	9,54	6470468
WR0400M04P00PC	4	4,00	0,025	2,00	10,13	6470469
WR0500M05P00PC	5	5,00	0,025	2,50	12,18	6470470
WR0600M06P00PC	6	6,00	0,025	3,00	14,52	6470481
WR0800M08P00PC	8	8,00	0,025	4,00	17,41	6470482

NOTE: SSC = Pocket Seat Reference. To correspond with the SSC on the toolholder.

### ▼ Plunge feed rates

- first choice
- alternate choice

<b>P</b> Steel	<b>K</b> Cast Iron	<b>S</b> High-Temp Alloys
<b>M</b> Stainless Steel	<b>N</b> Non-Ferrous	<b>H</b> Hardened Materials

Chip Control	Description	Insert Geometry	Seat Size (SSC)	Corner Radius	Starting Conditions	Plunge Feed Rates mm/rev						
						mm	mm	0,05	0,10	0,15	0,20	0,25
-PT	Positive rake angle for lower cutting forces.		1F	0,2	0,06	0,05	0,10	0,15	0,20	0,25	0,30	0,35
			2	0,2	0,08	0,05	0,10	0,15	0,20	0,25	0,30	0,35
			3	0,2	0,09	0,05	0,10	0,15	0,20	0,25	0,30	0,35
				0,4	0,11	0,05	0,10	0,15	0,20	0,25	0,30	0,35
			4	0,4	0,12	0,05	0,10	0,15	0,20	0,25	0,30	0,35
				0,8	0,15	0,05	0,10	0,15	0,20	0,25	0,30	0,35
			5	0,4	0,15	0,05	0,10	0,15	0,20	0,25	0,30	0,35
				0,8	0,16	0,05	0,10	0,15	0,20	0,25	0,30	0,35
			6	0,4	0,15	0,05	0,10	0,15	0,20	0,25	0,30	0,35
				0,8	0,18	0,05	0,10	0,15	0,20	0,25	0,30	0,35
8	1,2	0,20	0,05	0,10	0,15	0,20	0,25	0,30	0,35			
	0,8	0,20	0,05	0,10	0,15	0,20	0,25	0,30	0,35			
-PN	Stable negative cutting edge allowing for more aggressive applications.		1F	0,2	0,06	0,05	0,10	0,15	0,20	0,25	0,30	0,35
			2	0,2	0,08	0,05	0,10	0,15	0,20	0,25	0,30	0,35
			3	0,2	0,09	0,05	0,10	0,15	0,20	0,25	0,30	0,35
				0,4	0,11	0,05	0,10	0,15	0,20	0,25	0,30	0,35
			4	0,4	0,12	0,05	0,10	0,15	0,20	0,25	0,30	0,35
				0,8	0,15	0,05	0,10	0,15	0,20	0,25	0,30	0,35
			5	0,4	0,15	0,05	0,10	0,15	0,20	0,25	0,30	0,35
				0,8	0,16	0,05	0,10	0,15	0,20	0,25	0,30	0,35
			6	0,4	0,15	0,05	0,10	0,15	0,20	0,25	0,30	0,35
				0,8	0,18	0,05	0,10	0,15	0,20	0,25	0,30	0,35
8	1,2	0,20	0,05	0,10	0,15	0,20	0,25	0,30	0,35			
	0,8	0,20	0,05	0,10	0,15	0,20	0,25	0,30	0,35			
10	1,2	0,22	0,05	0,10	0,15	0,20	0,25	0,30	0,35			
	1,2	0,24	0,05	0,10	0,15	0,20	0,25	0,30	0,35			

### ▼ Cut-Off Feed Rates

Geometry	Description	Insert Geometry	Seat Size (SSC)	Starting Conditions	Cut-Off Feed Rates mm/rev							
					mm	0,05	0,10	0,15	0,20	0,25	0,30	0,35
-F	Positive geometry for reduced cutting forces.		1B	0,06	0,05	0,10	0,15	0,20	0,25	0,30	0,35	0,40
			2	0,07	0,05	0,10	0,15	0,20	0,25	0,30	0,35	0,40
			3	0,09	0,05	0,10	0,15	0,20	0,25	0,30	0,35	0,40
			4	0,11	0,05	0,10	0,15	0,20	0,25	0,30	0,35	0,40
			5	0,13	0,05	0,10	0,15	0,20	0,25	0,30	0,35	0,40
-M	Stable cutting edge for aggressive feed rates. Primarily in cast iron.		1B	0,06	0,05	0,10	0,15	0,20	0,25	0,30	0,35	0,40
			2	0,07	0,05	0,10	0,15	0,20	0,25	0,30	0,35	0,40
			3	0,09	0,05	0,10	0,15	0,20	0,25	0,30	0,35	0,40
			4	0,11	0,05	0,10	0,15	0,20	0,25	0,30	0,35	0,40
			5	0,14	0,05	0,10	0,15	0,20	0,25	0,30	0,35	0,40
			6	0,16	0,05	0,10	0,15	0,20	0,25	0,30	0,35	0,40
-R	Most stable cutting edge for steel.		2	0,10	0,05	0,10	0,15	0,20	0,25	0,30	0,35	0,40
			3	0,14	0,05	0,10	0,15	0,20	0,25	0,30	0,35	0,40
			4	0,16	0,05	0,10	0,15	0,20	0,25	0,30	0,35	0,40
			5	0,19	0,05	0,10	0,15	0,20	0,25	0,30	0,35	0,40
			6	0,21	0,05	0,10	0,15	0,20	0,25	0,30	0,35	0,40
			8	0,23	0,05	0,10	0,15	0,20	0,25	0,30	0,35	0,40

NOTE: For cut-off inserts with a lead angle, maximum feed rate should be reduced by up to 40%.

### Maximum Feed Rate Values

Data above is for P and K material groups. <b>Maximum</b> feed rates should be adjusted by multiplying max feed rate values by following factors for shown material groups.	Material Group	Feed Factor
	<b>M</b>	0.8
	<b>N</b>	1.2
	<b>S</b>	0.8
	<b>H</b>	0.5

### I.D. and Face Grooving

For I.D. and face grooving applications, reduce feed rate by 20%.

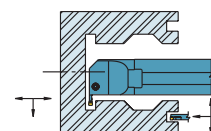

▼ Turn and profile feed rates

Seat Size 1F

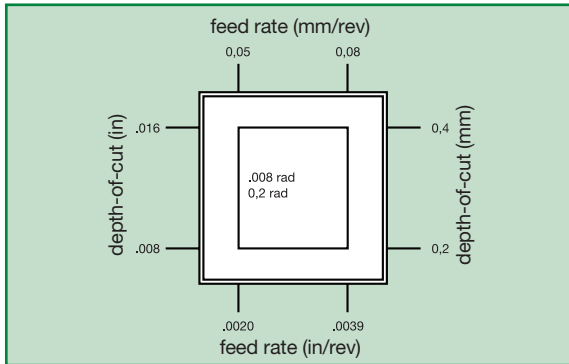

Seat Size 2

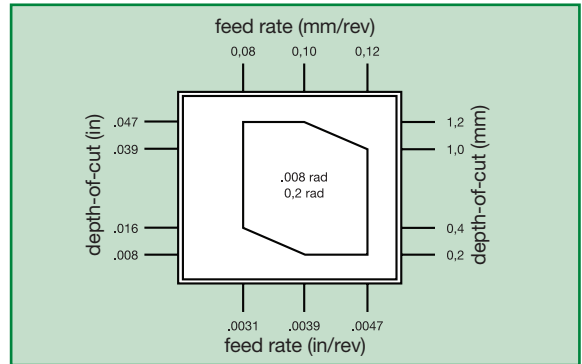

Seat Size 3

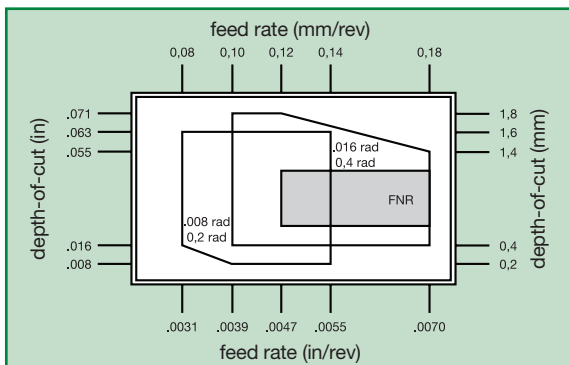

Seat Size 4

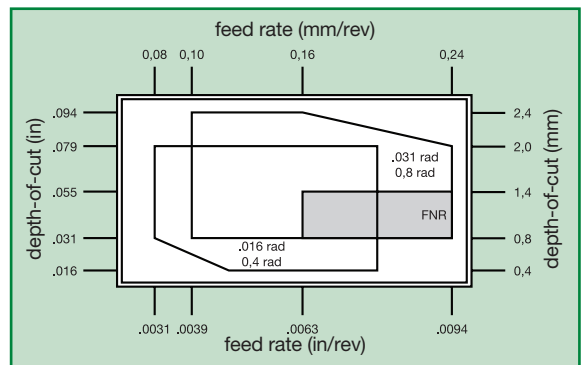

Seat Size 5

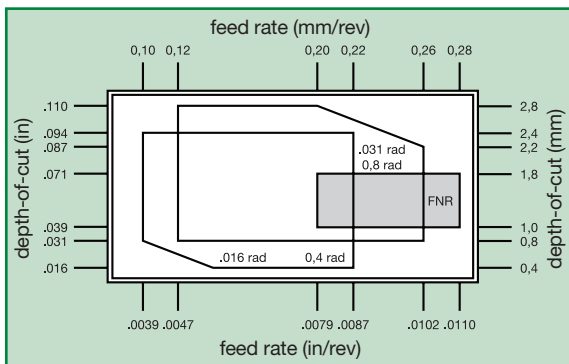

Seat Size 6

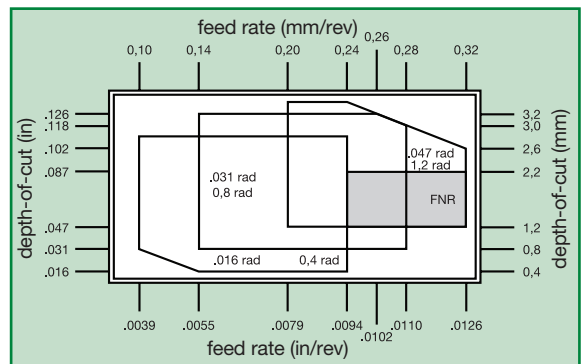

Seat Size 8

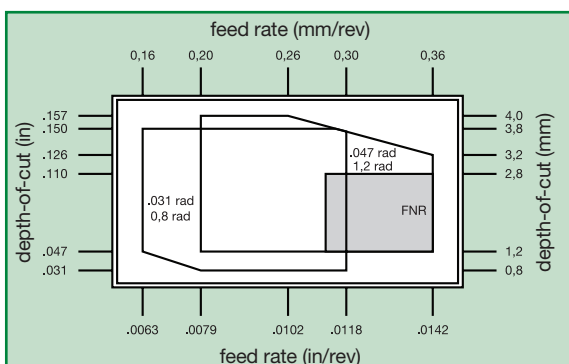

Seat Size 10

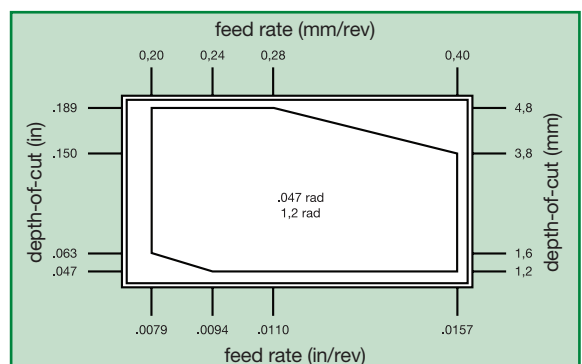

\* FNR = Full Nose Radius



### Maximum Feed Rate Values

Data above is for P and K material groups. <b>Maximum</b> feed rates should be adjusted by multiplying max feed rate values by following factors for shown material groups.	Material Group	Feed Factor
	M	0.8
	N	1.2
	S	0.8
	H	0.5

### Recommended Starting Speeds • Inch and Metric

Material Group		WU25PT					
		Inch			Metric		
P	0-1	360	<b>740</b>	880	110	<b>225</b>	270
	2	360	<b>520</b>	880	110	<b>160</b>	260
	3	360	<b>410</b>	800	110	<b>125</b>	235
	4	200	<b>290</b>	540	60	<b>90</b>	160
	5	320	<b>530</b>	680	100	<b>160</b>	210
	6	280	<b>400</b>	600	85	<b>120</b>	185
M	1	300	<b>550</b>	800	90	<b>170</b>	245
	2	300	<b>500</b>	800	90	<b>150</b>	245
	3	300	<b>450</b>	700	90	<b>140</b>	210
K	1	320	<b>480</b>	760	100	<b>145</b>	225
	2	240	<b>400</b>	560	70	<b>120</b>	170
	3	160	<b>280</b>	400	50	<b>85</b>	120
N	1-2	400	<b>1440</b>	2560	120	<b>440</b>	780
	3	—	—	—	—	—	—
	4	320	<b>960</b>	1600	100	<b>290</b>	490
	5	240	<b>440</b>	640	70	<b>135</b>	195
	6	320	<b>560</b>	800	100	<b>170</b>	245
S	1	25	<b>125</b>	200	8	<b>40</b>	60
	2	25	<b>100</b>	250	8	<b>30</b>	75
	3	50	<b>125</b>	250	15	<b>40</b>	75
	4	25	<b>175</b>	350	8	<b>50</b>	110

NOTE: FIRST choice starting speeds are in **bold** type.  
As the average chip thickness increases, the speed should be decreased.



### Internal Coolant Delivery

#### Geometry placement is a key factor to coolant delivery!

Engineers positioned WGC geometry in the perfect position to spread the coolant across the cutting edge for maximum performance.

#### Coolant parameters

WGC is capable of both low and high pressure coolant up 350 bar (5076 psi) with no lower limit.

Tech Tip — If performance is not being achieved due to the machine pump's inability to provide pressure, even if volume is acceptable, flood coolant should also be applied.

#### Performance

Internal tests have shown up to 30% increased tool life.















Tech Tip — Regular maintenance of coolant filtration system required to achieve maximum performance.

#### Coolant entry

WGC offers multiple coolant ports for convenience.



▼ Coolant Kit

Component Description														
1/16 NPTF MALE TO JIC MALE	1/8 NPTF MALE TO JIC MALE	M8 X 1.25 MALE TO JIC MALE	M8 X 1.0 MALE TO JIC MALE	G1/8 MALE TO JIC MALE	M10 MALE TO JIC MALE	MALE JIC TO FEMALE JIC ELBOW	HEAVY DUTY 200MM COOLANT HOSE	HEAVY DUTY 300MM COOLANT HOSE	UNIV 200MM FLEX COOLANT HOSE	UNIV 300MM FLEX COOLANT HOSE	M8X1.0 BANJO 200MM FLEX HOSE	G1/8 BANJO 200MM FLEX HOSE	M8X1.0 BANJO 300MM FLEX HOSE	G1/8 BANJO 300MM FLEX HOSE
Component Order Number														
6145374	6145375	6145378	6475041	6145376	6145377	6145379	6145380	6145381	6432549	6432550	6475043	6475045	6475047	6475049
														

Kit Description	Order Number	Shank Size	Coolant Pressure	6145374	6145375	6145378	6475041	6145376	6145377	6145379	6145380	6145381	6432549	6432550	6475043	6475045	6475047	6475049
Universal 200mm flex hose coolant kit	6475019	12–40mm 1/2–1-1/2"	200 Bar 2,901 psi		•	•	•	•	•	•			•					
Universal 300mm flex hose coolant kit	6475021	12–40mm 1/2–1-1/2"	200 Bar 2,901 psi	•	•	•	•	•	•	•				•				
M8x1.0 banjo 200mm flex hose coolant kit	6475023	12–20mm 1/2–3/4"	200 Bar 2,901 psi					•	•	•					•			
M8x1.0 banjo 300mm flex hose coolant kit	6475025	12–20mm 1/2–3/4"	200 Bar 2,901 psi					•	•	•							•	
G 1/8 banjo 200mm flex hose coolant kit	6475027	25–40mm 1–1-1/2"	200 Bar 2,901 psi					•	•	•						•		
G 1/8 banjo 300mm flex hose coolant kit	6475029	25–40mm 1–1-1/2"	200 Bar 2,901 psi					•	•	•								•
Universal 200mm heavy-duty coolant kit	6145372	25–40mm 1–1-1/2"	350 Bar* 5,076 psi*	•	•			•	•	•	•							
Universal 300mm heavy-duty coolant kit	6145373	25–40mm 1–1-1/2"	350 Bar* 5,076 psi*	•	•			•	•	•		•						

\* Max pressure for seat size 02 holders is 200 bar/2901 psi.



### ▼ Individual Kit Component List

order number	catalogue number	description
6145374	1-16NPTF-JIC	Straight fitting, 1/16 NPTF male thread to JIC male thread
6145375	1-8NPTF-JIC	Straight fitting, 1/8 NPTF male thread to JIC male thread
6145378	M8X1.25-JIC	Straight fitting, M8 x 1.25 male thread to JIC male thread
6475041	M8X1-JIC	Straight fitting, M8 x 1.0 male thread to JIC male thread
6145376	G18-JIC	Straight fitting, G 1/8 male thread to JIC male thread
6145377	M10X1.5-JIC	Straight fitting, M10 x 1.5 male thread to JIC male thread
6145379	JICM-JICF-ELB	Elbow fitting, male JIC thread to female JIC thread
6145380	COOL-HOSE-200-HD	Heavy Duty 200mm Coolant hose with JIC female fitting both ends
6145381	COOL-HOSE-300-HD	Heavy Duty 300mm Coolant hose with JIC female fitting both ends
6432549	COOL-HOSE-200-FLEX	Flexible braided 200mm Coolant hose with JIC female fitting both ends
6432550	COOL-HOSE-300-FLEX	Flexible braided 300mm Coolant hose with JIC female fitting both ends
6475043	M8X1-BAN-JIC-HOSE-200	Flexible braided 200mm Coolant hose, M8 x 1.0 male thread to JIC female thread. Contains (1) M8x1.0 banjo bolt and (2) M8 bonded washers
6475045	G18-BAN-JIC-HOSE-200	Flexible braided 200mm Coolant hose, G 1/8 male thread to JIC female thread. Contains (1) G 1/8 banjo bolt and (2) G 1/8 bonded washers
6475047	M8X1-BAN-JIC-HOSE-300	Flexible braided 300mm Coolant hose, M8 x 1.0 male thread to JIC female thread. Contains (1) M8x1.0 banjo bolt and (2) M8 bonded washers
6475049	G18-BAN-JIC-HOSE-300	Flexible braided 300mm Coolant hose, G 1/8 male thread to JIC female thread. Contains (1) G 1/8 banjo bolt and (2) G 1/8 bonded washers



### ▼ Coolant Accessories

The items shown below are not part of any coolant kits shown on previous pages.

order number	catalogue number	description
6145382	M6X1-JIC	Straight fitting, M6 x 1.0 male thread to JIC male thread
6145383	JICM-JICM-STR	Straight fitting, JIC male thread to JIC male thread
6145386	G14-G18-RED	Straight fitting, G 1/4 male thread to G 1/8th male thread
6475058	R18-JIC	Straight fitting, 1/8 BSPT male thread to JIC male thread
6475059	R14-JIC	Straight fitting, 1/4 BSPT male thread to JIC male thread

### ▼ Coolant Spare Parts

Included in kits; part of components.

order number	catalogue number	description
6475051	M8X1-BAN-BOLT	Banjo bolt, M8 x 1.0 male thread
6475053	G18-BAN-BOLT	Banjo bolt, G1/8 male thread
6475060	M6-BON-WASHER	M6 bonded washer
6475055	M8-BON-WASHER	M8 bonded washer
6475061	M10-BON-WASHER	M10 bonded washer
6475056	G18-BON-WASHER	G 1/8 bonded washer

## WGC Application Guidelines

### Internal Coolant Delivery Guidelines

1. WGC system capable of 5076 psi (350 bar).
2. Toolholder delivered with four entry holes.
3. A quality filtration system is necessary to prevent blockages in the toolholder that will affect coolant flow and performance.
4. Machines without a proper filtering system may require modification or an inline filter.
  - For pressure >1015 psi [70 bar], use 10–20 µm filter.
  - For pressure <1015 psi [70 bar], 50–100 µm.
  - Using fine filters in low-pressure applications may affect flow rate.

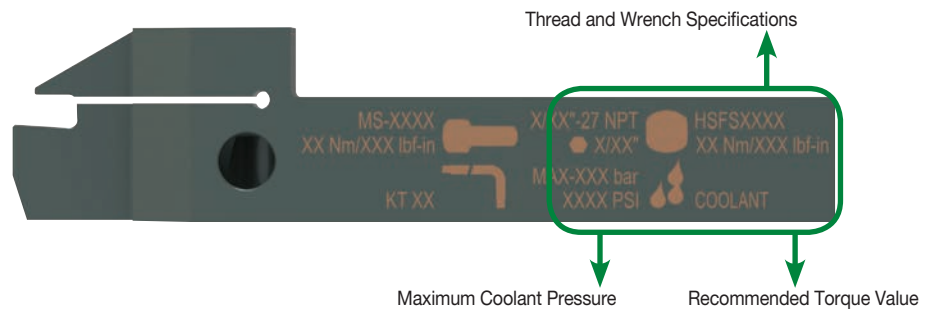
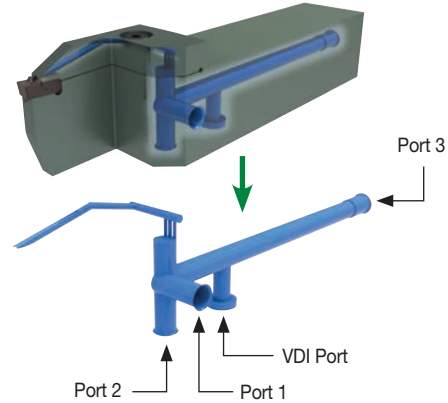

### General Safety Guidelines

1. All safety doors and mechanisms must be in place before trying out the internal coolant to avoid any danger to the operator in the event of a failure.
2. Use the correct pipe fittings to connect the holders to the system. Ensure the maximum pressure recommended for the fittings are not exceeded.
3. While implementing pressure >1160 psi [80 bar], increase the pressure in steps to ensure proper functioning of insert clamping and leak-free joints.
4. While indexing inserts, ensure the pocket is free from chips and/or dirt. Also, inspect the insert and make sure there are no blockages in the coolant canal.
5. Periodically check all hoses and fittings for damage and wear for proper functioning of the system. This check should also include filters.

### Internal Coolant Delivery Performance

Internal coolant offers a clear advantage in tool life and chip forming/evacuation vs. external coolant in difficult conditions and in high-pressure coolant.

*Example: Chipbreaking in plunging of steel.*

Flood Coolant



Material steel ST52;  
Insert size 6mm; f = 0,25 mm/U

Internal Coolant



1,087 psi  
(75 bar)



2,900 psi  
(200 bar)

**Low Pressure** — If performance is at risk due to low coolant pressure, apply internal coolant in combination with external coolant to increase volume.

**Recommendation to improve tool life and/or productivity:** Apply high pressure coolant: 80–350 bar recommended.















### VDI Assemblies

The WGC internal coolant delivery can be leveraged with VDI holding systems with both traditional or Quick-Change coolant connections.























# Informational Icons Guide

## Indexable Milling Icons



















 Counterboring	 Spiral Circular	 Face Milling	 Helical Milling	 Plunge Milling
 Ramping	 Slotting: Square End	 Side Milling/ Shoulder Milling: Square End	 3D Profiling: Inclined Square End Mill	 Pocketing
 Cylindrical/Plain Shank	 Weldon® Shank	 Screw-On Shank	 Shell Mill	 Through Coolant

## Solid End Milling Icons









 Ramping: Blank	 Slotting: Square End	 Slotting: Square End with AP Dimension	 Side Milling/ Shoulder Milling: Square End	 Side Milling/ Shoulder Milling: Square End with AE/AP Dimension
 3D Profiling	 3D Profiling: 3D Profiling with AE/AP Dimensions	 Corner Style: Corner Radius	 Corner Style: Square End	 Corner Style: Torus
 Cylindrical/Plain Shank	 Helix Angle: 20°	 Helix Angle: 30°	 Helix Angle: 40°	 Helix Angle: 45°
 DIN 6527	 ZU-X Tool Dimensions: Flute Configuration: X (Variable)	 ZU-2 Tool Dimensions: Flute Configuration: 2	 ZU-3 Tool Dimensions: Flute Configuration: 3	 ZU-6 Tool Dimensions: Flute Configuration: 6

# Informational Icons Guide

## Holemaking Icons

 Drilling	 Drilling: Inclined Entry	 Drilling: Inclined Exit	 Drilling: X-Offset	 Drilling: Stacked Plates
 Drilling: Convex	 Drilling: Blind	 Chain Drilling	 Drilling: Cross Hole	 Drilling: Half Cylinder
 Drilling: Corner Drilling 45°	 Drilling Depth: 3x	 Drilling Depth: 5x	 Drilling Depth: 8x	 Flat Shank
 Through Coolant: Radial: Drilling	 Through Coolant: Radial: Indexable Drilling	 Tool Dimensions: 2-Flute/2-Margin/Coolant		

## Turning Icons

 Turning	 Profiling	 Facing	 Face Grooving	 Chamfering
 Grooving	 Cut-off	 Deep Grooving	 Through Coolant: Grooving	

DIN — German Institute for Standardisation  
 ISO — International Standardisation Organisation

# Customer Application Support (CAS)

## Get fast and reliable answers to your toughest metalcutting problems.

Our Customer Application Support (CAS) Team is the metalworking industry's leading help desk resource for tooling application solutions and problem resolution.

- Easy access to proven metalworking expertise.
- Service level excellence.
- Best-in-class application support tools and technology.

## Easy access to proven metalworking expertise!

WIDIA™ Customer Application Engineers assist customers and engineering groups throughout the world with expert tool selection and application recommendations for the entire range of WIDIA tooling.

### Service Level Excellence:

- Fast telephone response.
- Quick technical solutions.
- Efficient case management.

### Services Provided:

- Tooling selection.
- Operating parameters.
- Troubleshooting.
- Process optimisation.
- Hardware support.

### Best-in-Class Support Tools and Technology:

- Tooling performance experts.
- Materials database.
- Application calculators.

ORIGINATING COUNTRY	LANGUAGE	TEL	FAX	EMAIL
Australia	English	001-724-539-6921 *	001-724-539-6830 *	ap.techsupport@widia.com
Austria	German	0800 291630	0049-911-9735-429 *	eu.techsupport@widia.com
Belgium	English/French	0800 80410	0049-911-9735-429 *	eu.techsupport@widia.com
China	Chinese	400-889-2237	+86-21-58999985 *	w-cn.techsupport@widia.com
Denmark	English	808 89295	001-724-539-6830 *	na.techsupport@widia.com
Finland	English	0800 919413	001-724-539-6830 *	na.techsupport@widia.com
France	French	080 5540 379	0049-911-9735-429 *	eu.techsupport@widia.com
Germany	German	0800 1015774	0911-9735-429*	eu.techsupport@widia.com
India	English	1 800 103 5227	—	in.techsupport@widia.com
Israel	English	1809 449907	001-724-539-6830 *	na.techsupport@widia.com
Italy	Italian	800 916568	02 89512146 *	eu.techsupport@widia.com
Japan	English	001-724539-6921 *	001-724-539-6830 *	ap.techsupport@widia.com
Korea (South)	English	001-724539-6921 *	001-724-539-6830 *	ap.techsupport@widia.com
Malaysia	English	001-724539-6921 *	001-724-539-6830 *	ap.techsupport@widia.com
Netherlands	English	0800 0201131	001-724-539-6830 *	na.techsupport@widia.com
New Zealand	English	001-724539-6921 *	001-724-539-6830 *	ap.techsupport@widia.com
Norway	English	800 10081	001-724-539-6830 *	na.techsupport@widia.com
Poland	Polish	00800 4411943	06166 56504 *	eu.techsupport@widia.com
Russia (landline)	Russian	8800 5556395	0048 6166 56504 *	eu.techsupport@widia.com
Russia (cell phone)	Russian	+7 8005556395	0048 6166 56504 *	eu.techsupport@widia.com
Singapore	English	001-724539-6921 *	001-724-539-6830 *	ap.techsupport@widia.com
South Africa	English	0800 981644	001-724-539-6830 *	na.techsupport@widia.com
Sweden	English	020798794	001-724-539-6830 *	na.techsupport@widia.com
Taiwan	English	001-724539-6921 *	001-724-539-6830 *	ap.techsupport@widia.com
Thailand	English	001-724539-6921 *	001-724-539-6830 *	ap.techsupport@widia.com
United Kingdom	English	0800 028 2996	001-724-539-6830 *	na.techsupport@widia.com
Ukraine	Russian	800502665	0048 6166 56504 *	eu.techsupport@widia.com
USA	English	888 539 5145	001-724-539-6830 *	na.techsupport@widia.com

\*Noted phone and fax numbers are not toll free.

# Material Overview • DIN

## DIN

<b>P</b> Steel	<b>K</b> Cast Iron	<b>S</b> High-Temp Alloys
<b>M</b> Stainless Steel	<b>N</b> Non-Ferrous	<b>H</b> Hardened Materials

material group	description	content	tensile strength RM (MPa)*	hardness (HB)	hardness (HRC)	material number
<b>P0</b>	Low-Carbon Steels, Long Chipping	C <0,25%	<530	<125	–	–
<b>P1</b>	Low-Carbon Steels, Short Chipping, Free Machining	C <0,25%	<530	<125	–	C15, Ck22, ST37-2, S235JR, 9SMnPb28, GS38
<b>P2</b>	Medium- and High-Carbon Steels	C >0,25%	>530	<220	<25	ST52, S355JR, C35, GS60, Cf53
<b>P3</b>	Alloy Steels and Tool Steels	C >0,25%	600–850	<330	<35	16MnCr5, Ck45, 21CrMoV5-7, 38SMn28
<b>P4</b>	Alloy Steels and Tool Steels	C >0,25%	850–1400	340–450	35–48	100Cr6, 30CrNiMo8, 42CrMo4, C70W2, S6525, X120Mn12
<b>P5</b>	Ferritic, Martensitic, and PH Stainless Steels	–	600–900	<330	<35	100Cr6, 30CrNiMo8, 42CrMo4, C70W2, S6525, X120Mn12
<b>P6</b>	High-Strength Ferritic, Martensitic, and PH Stainless Steels	–	900–1350	350–450	35–48	X102CrMo17, G-X120Cr29
<b>M1</b>	Austenitic Stainless Steel	–	<600	130–200	–	X5CrNi 18 10, X2CrNiMo 17 13 2, G-X25CrNiSi 18 9, X15CrNiSi 20 12
<b>M2</b>	High-Strength Austenitic Stainless and Cast Stainless Steels	–	600–800	150–230	<25	X2CrNiMo 13 4, X5NiCr 32 21, X5CrNiNb 18 10, G-X15CrNi 25-20
<b>M3</b>	Duplex Stainless Steel	–	<800	135–275	<30	X8CrNiMo27 5, X2CrNiMoN22 5 3, X20CrNiSi25 4, G-X40CrNiSi27 4
<b>K1</b>	Grey Cast Iron	–	125–500	120–290	<32	GG15, GG25, GG30, GG40, GTW40
<b>K2</b>	Low- and Medium-Strength Ductile Irons (Nodular Irons) and Compacted Graphite Irons (CGI)	–	<600	130–260	<28	GGG40, GTS35
<b>K3</b>	High-Strength Ductile Irons and Austempered Ductile Iron (ADI)	–	>600	180–350	<43	GGG60, GTW55, GTS65
<b>N1</b>	Wrought Aluminium	–	–	–	–	AlMg1, Al99.5, AlCuMg1, AlCuBiPb, AlMgSi1, AlMgSiPb
<b>N2</b>	Low-Silicon Aluminium Alloys and Magnesium Alloys	Si <12,2%	–	–	–	GAISiCu4, GDAISi10Mg
<b>N3</b>	High-Silicon Aluminium Alloys and Magnesium Alloys	Si >12,2%	–	–	–	G-ALSi12, G-AISi17Cu4, G-AISi21CuNiMg
<b>N4</b>	Copper-, Brass-, Zinc-Based on Machinability Index Range of 70–100	–	–	–	–	CuZn40, Ms60, G-CuSn5ZnPb, CuZn37, CuSi3Mn
<b>N5</b>	Nylon, Plastics, Rubbers, Phenolics, Resins, Fibreglass	–	–	–	–	Lexan®, Hostalen™, Polystyrol, Makralon®
<b>N6</b>	Carbon, Graphite Composites, CFRP	–	–	–	–	CFK, GFK
<b>N7</b>	Metal Matrix Composites (MMC)	–	–	–	–	–
<b>S1</b>	Iron-Based, Heat-Resistant Alloys	–	500–1200	160–260	25–48	X1NiCrMoCu32 28 7, X12NiCrSi36 16, X5NiCrAlTi31 20, X40CoCrNi20 20
<b>S2</b>	Cobalt-Based, Heat-Resistant Alloys	–	1000–1450	250–450	25–48	Haynes® 188, Stellite® 6,21,31
<b>S3</b>	Nickel-Based, Heat-Resistant Alloys	–	600–1700	160–450	<48	INCONEL® 690, INCONEL 625, Hastelloy®, Nimonic® 75
<b>S4</b>	Titanium and Titanium Alloys	–	900–1600	300–400	33–48	Ti1, TiAl5Sn2, TiAl6V4, TiAl4Mo4Sn2
<b>H1</b>	Hardened Materials	–	–	–	44–48	GX260NiCr42, GX330NiCr42, GX300CrNiSi952, GX300CrMo153, Hardox® 400
<b>H2</b>	Hardened Materials	–	–	–	48–55	–
<b>H3</b>	Hardened Materials	–	–	–	56–60	–
<b>H4</b>	Hardened Materials	–	–	–	>60	–



# WIDIA™ Digital Solutions

Tools and Resources at Your Fingertips

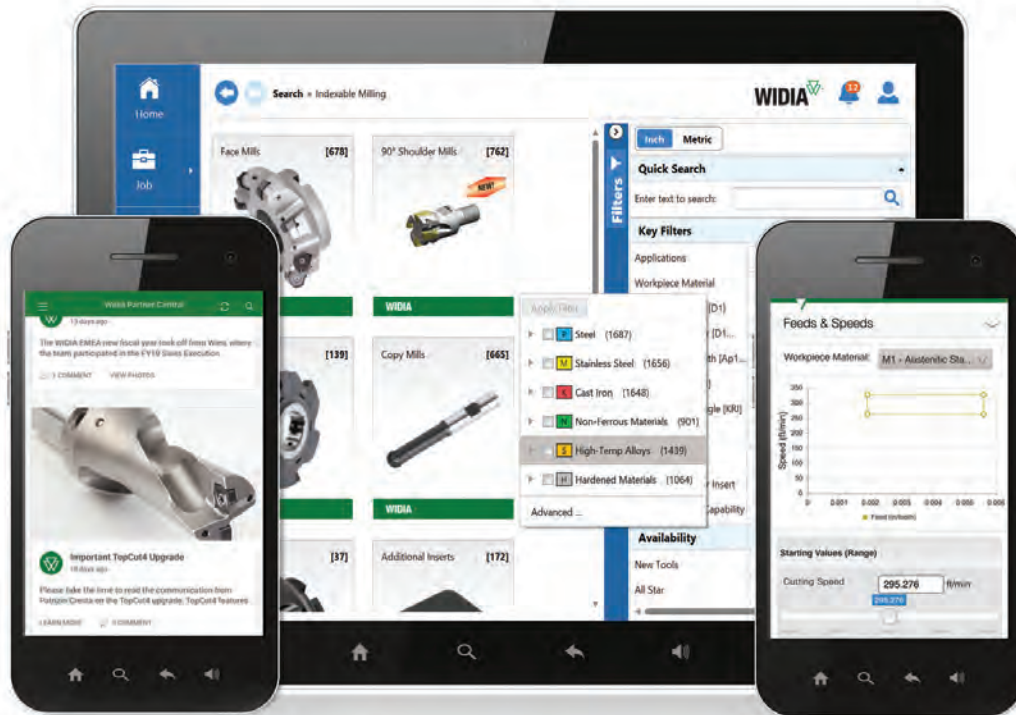

**WIDIA  
Machining  
Central**



**WIDIA  
NOVO™**



**WIDIA  
Partner  
Central**

## PRODUCT DATA

- Tooling Dimensional Data
- Feeds and Speeds
- Inventory Availability
- ...and More!

## ELECTRONIC CATALOGUE

- Complete cutting tool assortment, cutting data, and 2D/3D models.
- Build cutting tool assemblies for easy import into CAD/CAM software, pre-setters, and tool management systems.

## PARTNER RESOURCES

- News and updates about our products and services.
- Partner Resources — training, product sheets, marketing templates, campaign collateral, emails, branding elements, merchandise, upcoming webinars, etc.

DOWNLOAD THE WIDIA MOBILE APPS TODAY!



WIDIA.COM









# The NOVO™ Application Provides the Digital Power

To Get Information Quicker  
Than Ever Before.

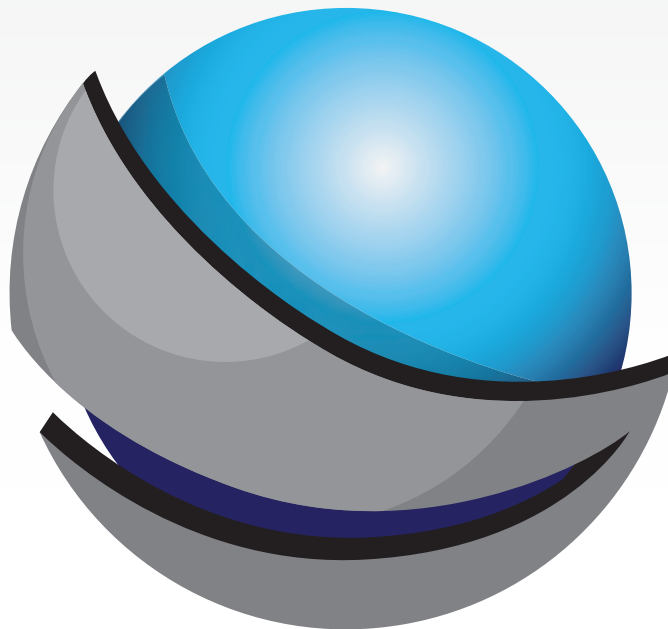

## New for 2018 — Export Compatibility to Mastercam®

- Select tools, save into “job lists”.
- Interactive feed & speed calculators.
- Find inventory availability.
- Download 2-D and 3-D models.
- Easy interface with many CAM and tool management data systems.

# Find your Local WIDIA Authorised Distributor

WIDIA™ brand cutting tools are available exclusively through a specialised network of Authorised Distributor partners whom you can count on to deliver much more than products. Our distributors know us, and more importantly, they know you. They know better than anyone in the industry how to put the global power of WIDIA to work for you — in your industry, in your region, and for your business.

WIDIA distributor partners provide technical expertise that you can count on. They will show you how to:

- Significantly reduce cycle time.
- Improve machine tool utilisation.
- Achieve measurable productivity improvements.
- Take advantage of proven supply chain solutions.
- Access local inventory and best-in-class technical support.
- Request onsite demonstrations of the latest tooling technology.

And with thousands of turning, milling, holemaking, tapping, and tooling systems products available from WIDIA, you'll find everything you need from one single source.



Find your Local WIDIA Authorised Distributor by accessing our distributor finder at [widia.com](http://widia.com).

## IMPORTANT SAFETY INSTRUCTIONS: READ BEFORE USING THE TOOLS IN THIS CATALOGUE

# METALCUTTING SAFETY

### Projectile and Fragmentation Hazards

Modern metalcutting operations involve high spindle and cutter speeds and high temperatures and cutting forces. Hot metal chips may fly off the workpiece during metalcutting. Although cutting tools are designed and manufactured to withstand high cutting forces and temperatures, they can sometimes fragment, particularly if they are subjected to over-stress, severe impact, or other abuse.

To avoid injury:

- Always wear appropriate personal protective equipment, including safety goggles, when operating metalcutting machines or working nearby.
- Always make sure all machine guards are in place.

### Breathing and Skin Contact Hazards

Grinding carbide or other advanced cutting tool materials produces dust or mist containing metallic particles. Breathing this dust or mist — especially over an extended period — can cause temporary or permanent lung disease or make existing medical conditions worse. Contact with this dust or mist can irritate eyes, skin, and mucous membranes and may make existing skin conditions worse.

To avoid injury:

- Always wear breathing protection and safety goggles when grinding.
- Provide ventilation control and collect and properly dispose of dust, mist, or sludge from grinding.
- Avoid skin contact with dust or mist.

For more information, read the applicable Material Safety Data Sheet provided by WIDIA and consult General Industry Safety and Health Regulations, Part 1910, Title 29 of the Code of Federal Regulations.

These safety instructions are general guidelines. Many variables affect machining operations. It is impossible to cover every specific situation. The technical information included in this catalogue and recommendations on machining practices may not apply to your particular operation.

For more information, consult the WIDIA Metalcutting Safety booklet, available free from WIDIA at +1 724 539 5747 or fax +1 724 539 5439. For specific product safety and environmental questions, contact our Corporate Environmental Health and Safety Office at +1 724 539 5066 or fax +1 724 539 5372.

GTD Gun, NOVO, Top Cut 4, TOP DRILL, VariMill, VariMill I, VariMill II, VariMill III, VariTap, Victory, VSM890-12, VXF, VXF-07, VXF-12, WIDIA, WIDIA-GTD, WIDIA-Hanita, and X-Feed are trademarks of Kennametal, Inc. and are used as such herein. The absence of a product, service name, or logo from this list does not constitute a waiver of the Kennametal trademark or other intellectual property rights concerning that name or logo.

Weldon® is a registered trademark of Weldon Tool Company.

©Copyright 2018 by Kennametal Inc., Latrobe, PA 15650. All rights reserved.

**WIDIA** 

# ADVANCES

## 2019 METRIC

### WORLD HEADQUARTERS

#### WIDIA Products Group

Kennametal Inc.

1600 Technology Way  
Latrobe, PA 15650 USA

Tel: 1 800 979 4342

w-na.service@widia.com

### EUROPEAN HEADQUARTERS

#### WIDIA Products Group

Kennametal Europe GmbH

Rheingoldstrasse 50

CH 8212 Neuhausen am Rheinfall

Switzerland

Tel: +41 52 6750 100

w-ch.service@widia.com

### ASIA-PACIFIC HEADQUARTERS

#### WIDIA Products Group

Kennametal (Singapore) Pte. Ltd.

3A International Business Park

Unit #01-02/03/05, ICON@IBP

Singapore 609935

Tel: +65 6265 9222

w-sg.service@widia.com

### INDIA HEADQUARTERS

#### WIDIA Products Group

Kennametal India Limited

CIN: L27109KA1964PLC001546

8/9th Mile, Tumkur Road

Bangalore - 560 073

Tel: +91 80 2839 4321

w-in.service@widia.com