



XENO TRACK LIGHT

XENO-V-34-B/W



 Available in Black & White

DIMENSION

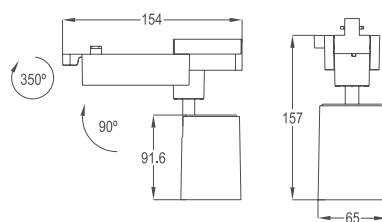

SPECIFICATIONS

- Wattage 15W
- Voltage 220 ~ 240 Vac
- Colour White / Black
- Track Single Phase
- LED COB
- CCT 3000K
- CRI >80
- SDCM <3
- Beam Angle 24°
- Life Span 35,000 hrs

XENO-V-3-B/W



 Available in Black & White

DIMENSION

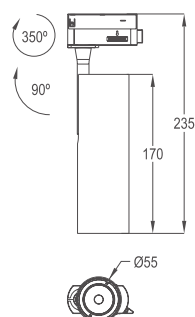

SPECIFICATIONS

- Wattage 20W
- Voltage 220 ~ 240 Vac
- Colour White / Black
- Track Single Phase
- LED COB
- CCT 3000K
- CRI >80
- SDCM <3
- Beam Angle 24°
- Life Span 35,000 hrs





XENO TRACK LIGHT

XENO-V-4-B/W



Available in Black & White

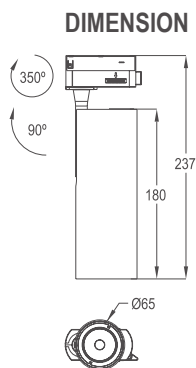

SPECIFICATIONS

- Wattage 30W
- Voltage 220 ~ 240 Vac
- Colour White / Black
- Track Single Phase
- LED COB
- CCT 3000K
- CRI >80
- SDCM <3
- Beam Angle 24°
- Life Span 35,000 hrs

XENO-V-27-B/W



Available in Black & White

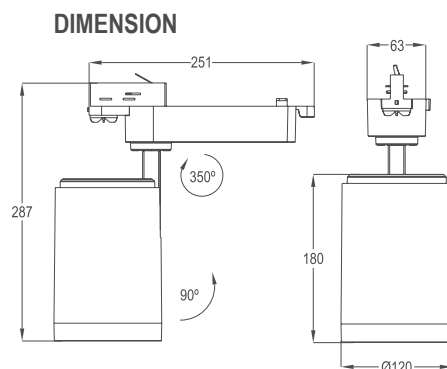

SPECIFICATIONS

- Wattage 50W
- Voltage 220 ~ 240 Vac
- Colour White / Black
- Track Single Phase
- LED COB
- CCT 3000K
- CRI >80
- SDCM <3
- Beam Angle 24°
- Life Span 35,000 hrs





XENO TRACK SYSTEM

- Input Voltage 220 ~ 240Vac
- Ingress Protection IP20

SINGLE PHASE TRACK



DIMENSION

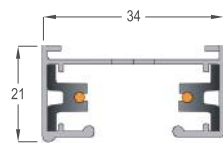

Order Code: NIKKON XENO TRACK IP 1M

STRAIGHT CONNECTOR



DIMENSION

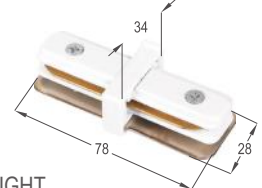

Order Code: NIKKON XENO STRAIGHT CONNECTOR 1

FEEDER



DIMENSION

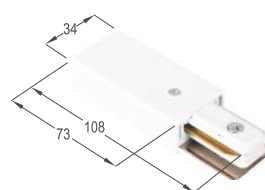

Order Code: NIKKON XENO FEEDER IP

T CONNECTOR



DIMENSION

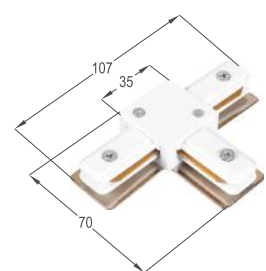

Order Code: NIKKON XENO T CONNECTOR 1P

L CONNECTOR



DIMENSION

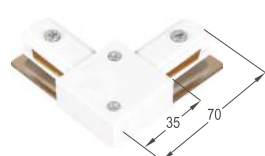

Order Code: NIKKON XENO L CONNECTOR 1P

END CAP



DIMENSION



Order Code: NIKKON XENO END CAP 1P