

NIKKON®

STAR SERIES



STAR-360W

LUMINAIRE SPECIFICATIONS

• Power	240W 360W 500W
• Fitting Material	Non-Corrosive- Die Cast Aluminium
• Fitting Color	White Aluminium, RAL9006
• Optical Cover	Clear Tempered Glass
• Ingress Protection	IP65
• Impact Protection	IK08
• Voltage	220-240Vac 50 / 60Hz
• Electrical Safety Class	Class 1
• Operating Temperature	-30 ~ +45°C
• Installation	Mounting Bracket
• Surge Protection	10KV, 20KA
• Beam Angle	15°, 20°, 35°, 50°, 60°

LED MODULE SPECIFICATIONS

• LED Chips	Cree CXA 2540
• Color Temperature	3000K, 4000K, 6500K
• Color Rendering Index (CRI)	>70
• L70	30,000 Hrs @ 25°C
• PCB Material	Metal Core

COMPLIANCE STANDARD

• LED	LM80, UL, RoHS
• Driver	CE, EN62493, EN61347, EN50581, EN55015, EN61000, EN 61547, EN62384

APPLICATION

- Sport Lightings, Stadium Lightings, Jetties & Highmasts.

MEASUREMENT & ORDER CODE

WATTAGE	TYPICAL FLUX, LM	TYPICAL WATTAGE	NETT WEIGHT
240W	26400	252W	11.2kg
360W	37800	378W	18kg
500W	55000	525W	29kg



DIMENSION

STAR-240W

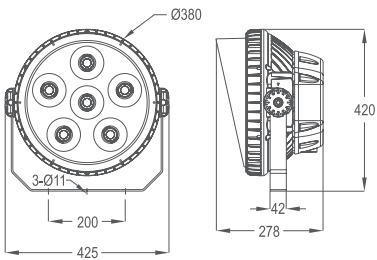

STAR-360W

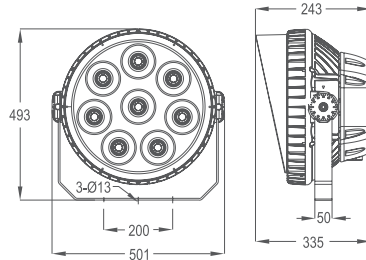

STAR-500W

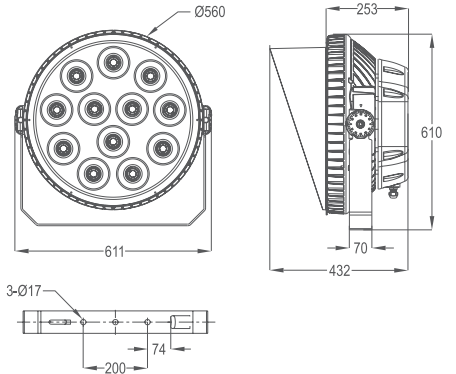

PHOTOMETRIC

BEAM ANGLE 15°

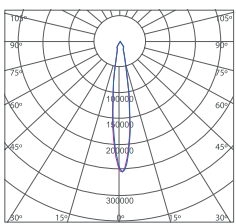

BEAM ANGLE 20°

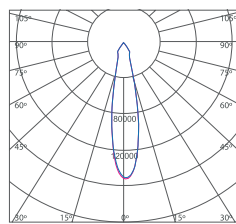

BEAM ANGLE 35°

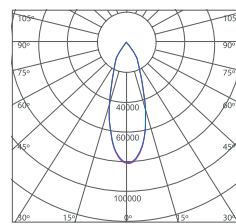

BEAM ANGLE 50°

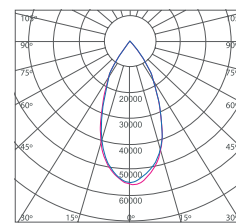

BEAM ANGLE 60°

