

Product Code	Description
HC4201TA-00M	100-240V LCD Thermostat (Cooling / Fan): Output 2A: with Isolated RS485



HC4201TA-00M



Product back view

Technical Specification

- Supply voltage: 100-240 VAC 50/60Hz
- Power consumption: <1.2W
- Valve/Fan relay rating: 2A, Resistive
- Recommended wire size:
0.5 mm² - 1.5 mm²
- Temperature setting range: 16-35°C
- Temperature accuracy: ±1°C
- Temp. compensation range: ±5°C
- Isolated RS-485 communication port
- Dimensions:
86 x 86 x 10 mm (WxHxD)
- Fix Center: 60.3mm
- Fix Screw: M3.5 x 0.6 x 30mm±
- Mounting box: >35mm depth
 - R1150, flush mounting, plastic (80 x 80 x 48.4mm) (WxHxD)
 - M1247, flush mounting, metal (79 x 73 x 47mm) (WxHxD)

Wiring Diagram:

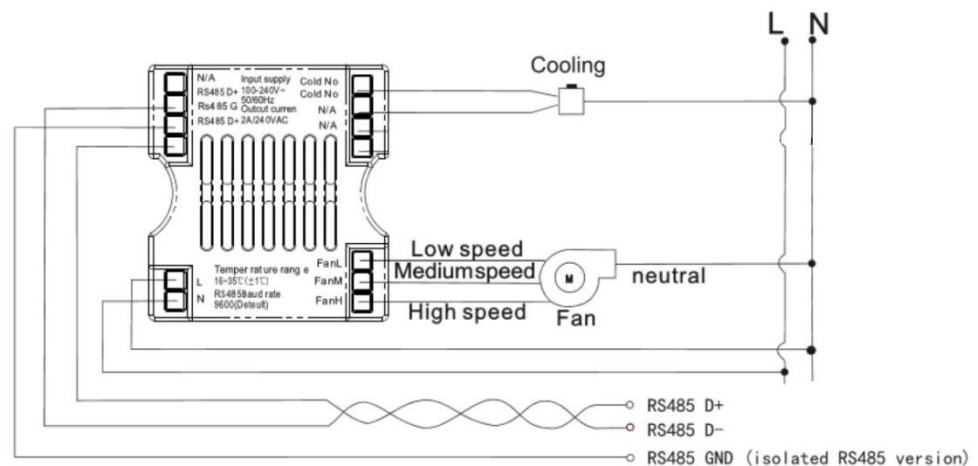

Installation Method

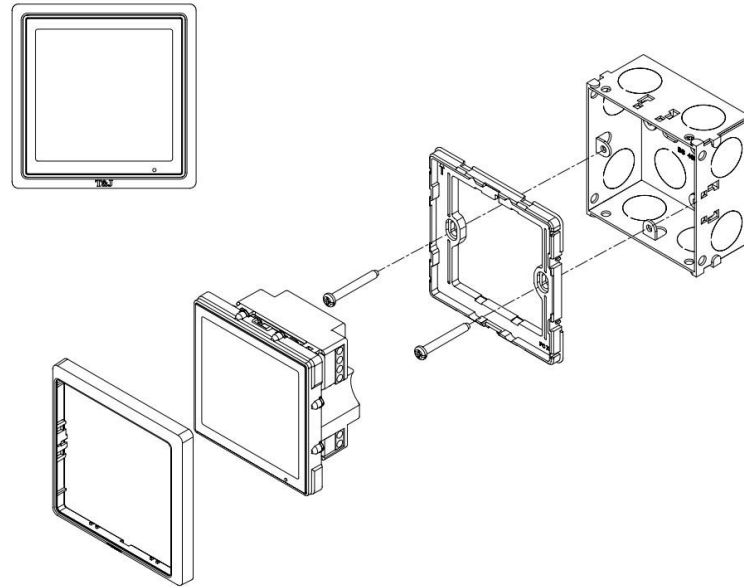

Installation Note:

- Wire according to the wiring diagram, otherwise it may cause damage to the product.
- Do not press on the LCD screen or the sides, this may cause the display screen to break or crack.
- Ensure the mounting surface is flat, do not knock on the product during installation.
- Connect RS485 GND to a common signal reference (0V) if port isolation is not available.

Other product options available:

Product code	Supply Voltage	Cooling + Fan mode	Heating mode	Dry mode	RS-485 Communication Port	
					Non-Isolated	Isolated GND
HC4201TA-00	100-240VAC	●				
HC4201TA-00A		●			●	
HC4201TA-00M		●				●
HC4201TA-02		●	●			
HC4201TA-02A		●	●	●		●
HC4201TA-02M		●	●	●		●
HC4201TA-90M	12VDC	●				●
HC4201TA-92A		●	●		●	
HC4201TA-92M		●	●	●		●
HC4201TA-93A		●	●	●	●	●
HC4201TA-93M		●	●	●	●	●

Thermostat Button - Operation

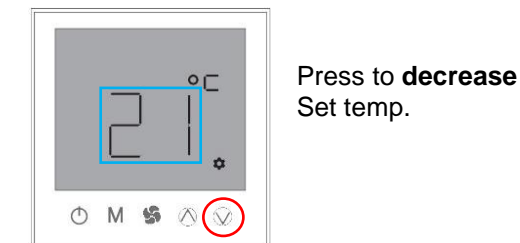
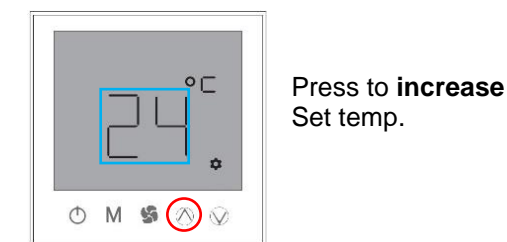
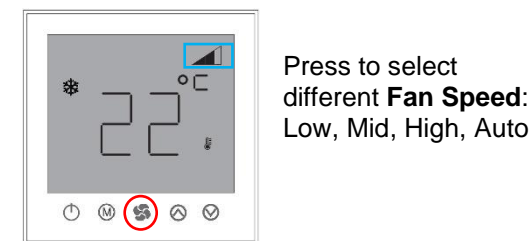
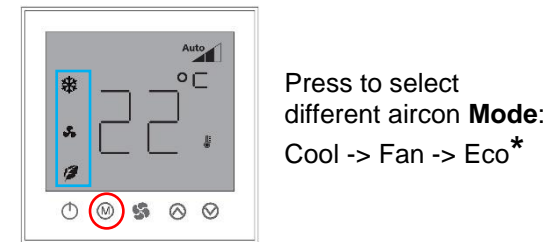
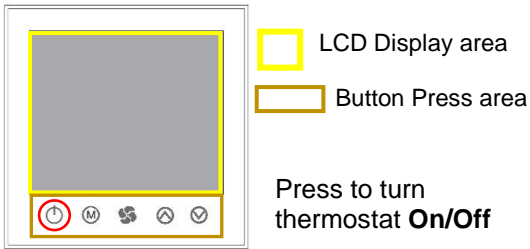

***Eco – Economy or Energy-Saving mode:**
 In Cooling mode: set temp. to 25°C, Low fan speed
 In Fan mode: set Low fan speed

Thermostat Button - Setting

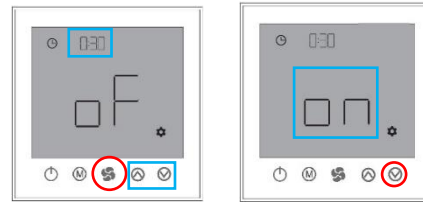

Temperature compensation:
 Press to off the thermostat
 Long press >5 secs.
 Press to set temperature compensation ($\pm 5^{\circ}\text{C}$)
 Press again to confirm & save

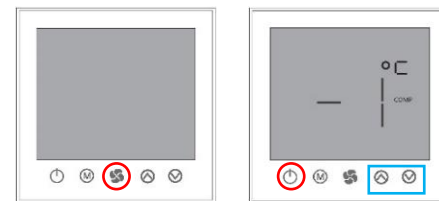

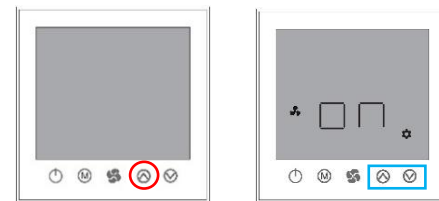
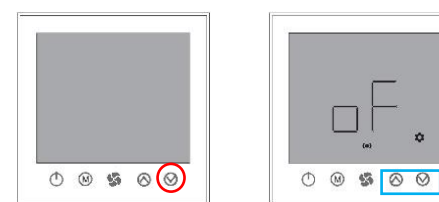

Beep sound mute On/Off
 Press to off the thermostat
 Long press >5 secs.
 Press to set beep On or Off
 Press again to confirm

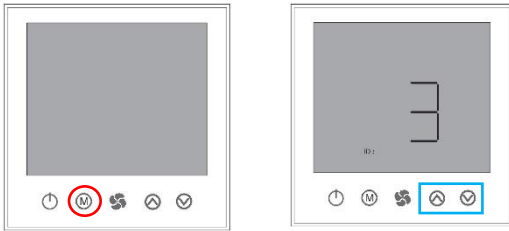

Set MODBUS ID

(Factory default ID: 3)



Press  to off the thermostat





Long press  >5 secs.

Press   to set Modbus ID

Press  again to confirm & save

RS-485 comms. port parameters:

9600 bps, 8 data-bits, 2 stop-bits, Parity: None

Product Code	Colour
HC4201TA-00M	 White
HC4201TA-00M-SBL	 Matt Black (SBL)
HC4201TA-00M-MSB	 Matt Silver Black (MSB)
HC4201TA-00M-PS7	 Dark Champagne (PS7)
HC4201TA-00M-ST5	 Champagne Grey (ST5)
<i>For other colours, please contact T&J Sales representative</i>	

