

Product Code	Description
JC1501A	Frame for 1 Column Key Pad



Frame front View
(With Keypad installed)



Frame back view
(With Keypad installed)

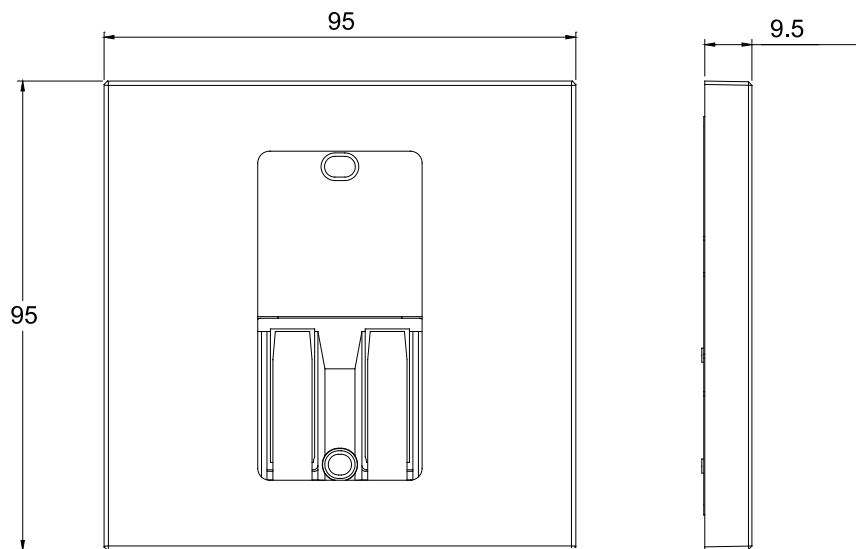

Frame Dimensions



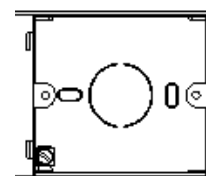

Technical Specification

- Exclusive frame for Lutron Pico Keypad
- Dimensions: 95 x 95 x 9.5mm (WxHxD)
- Fix Centre: 60.3 mm
- Metal Wall box (if required):
 - M1050, flush mounting
(75.5 x 66.8 mm x 50 mm)
(W x H x D)

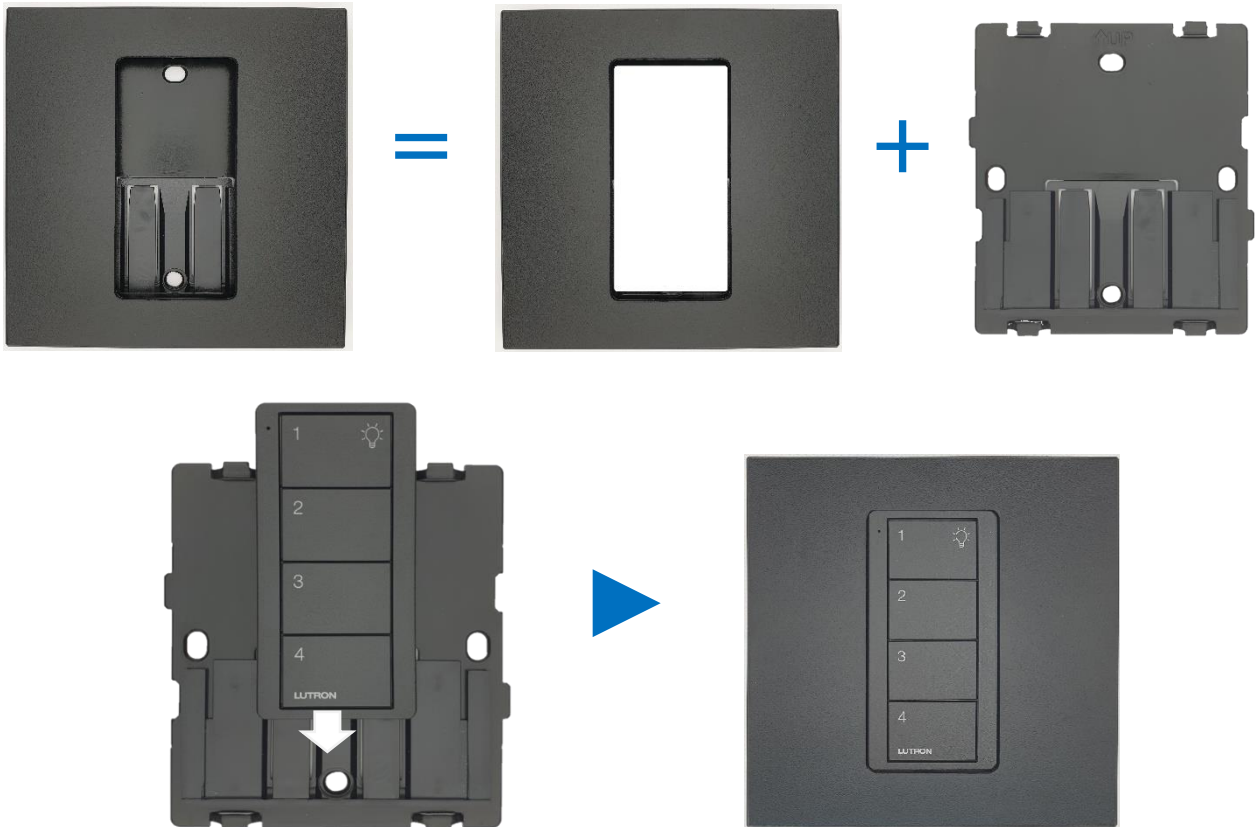

Frame + Pico Keypad Assembly



Product Code	Colour
JC1501A-LWH	 Matt White
JC1501A-LBL	 Matt Black
JC1501A-DAD	 Metallic-Spray Matt Grey
JC1501A-BL	 Metallic-Spray Black
<i>For other colours, please contact T&J Sales representative</i>	