

Product Code	Description
W8201TU / W8201-6TU	1 Gang 6 Core RJ12 Telephone Socket Outlet (Module)



W8201TU



Product back view

Technical Specification

- One Deco module size
- 6-position female jack
- With shutter dust cover
- Push-in termination
- Backward compatible with RJ11 (6P2C or 6P4C)
- Dimensions: 40 x 23 x 35 mm (HxWxD)
- Mounting box: >40 mm
 - R1150, flush mounting, plastic (80 x 80 x 48.4 mm) (WxHxD)
 - M1247, flush mounting, metal (79 x 73 x 47 mm) (WxHxD)

Typical wiring

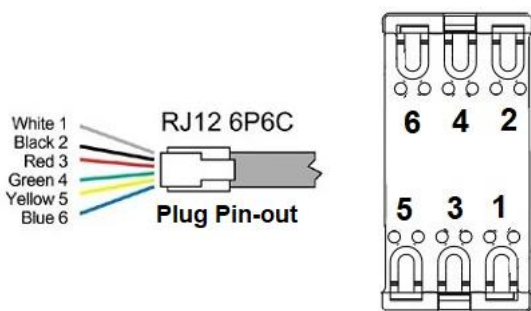

















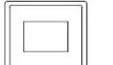

Terminal Number	Colour Code	Telephone Circuit		
		2-wire (6P2C)	4-wire (6P4C)	6-wire (6P6C)
1	White			✓
2	Black		✓	✓
3	Red	✓	✓	✓
4	Green	✓	✓	✓
5	Yellow		✓	✓
6	Blue			✓

Note:
 6P2C – 6 positions, 2 contacts
 6P4C – 6 positions, 4 contacts
 6P6C – 6 positions, 6 contacts

Note:

Use single core wire, strip away ~7mm insulation, press the release and insert wire to the respective hole.

Product Code	Colour
W8201TU	 White
W8201TU-SBL	 Matt Black (SBL)
W8201TU-ST	 Charcoal Black (ST)
W8201TU-MSB	 Matt Silver Black (MSB)
W8201TU-MSL	 Matt Silver (MSL)
<i>For other colours, please contact T&J Sales representative</i>	

Adapter plate for Deco module						
Series	Product Code					
	1 gang adapter plate		2 gang adapter plate		3 gang adapter plate	
deco	W1111		W1112A		W1113	
infinit	HC1231		HC1232			
HARMONY	EA1231		EA1232			
minimalist	EB1231		EB1232			
radiance	K1231-D		K1201-D			
Titanium	GC1231		GC1221			
Ultimate	G1231		G1221			

Adaptor plate for other series is available, please contact T&J Sales representative