

Product Code	Description
W2231	10A 250V 1 Gang Intermediate Switch (Module)

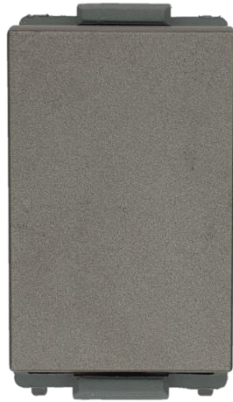

W2231-MSB









Product back view

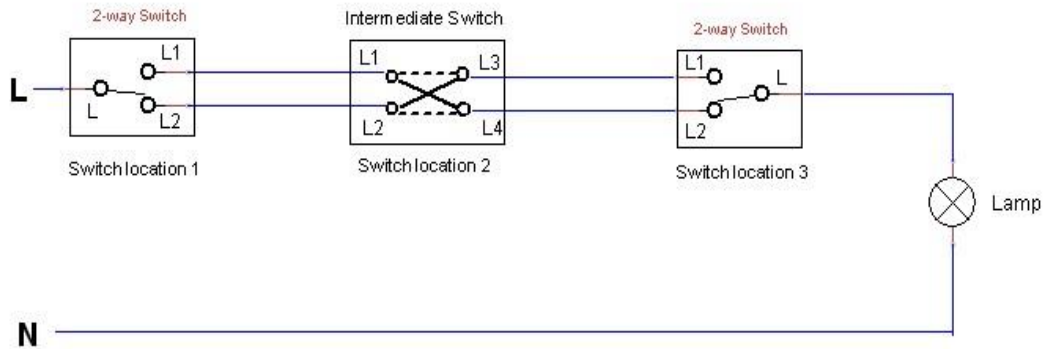







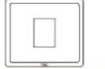
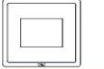
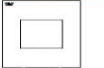

## Technical Specification

- One Deco module size
- Rated Voltage: 250V, 50/60Hz
- Rated Current: 10AX
- Recommended wire size:  
1.5mm<sup>2</sup> - 2.5mm<sup>2</sup>
- Isolating Gap Contact: 3mm nominal
- Contact Material: Silver-Nickel Alloy
- Operating Temperature:  
-5°C to +40°C
- IP Rating: IP2X
- No. of operations: 40,000 at 10 Amp.
- Dimensions: 40 x 23 x 30 mm (HxWxD)
- Mounting box: >35 mm
  - R1150, flush mounting, plastic (80 x 80 x 48.4 mm) (WxHxD)
  - M1247, flush mounting, metal (79 x 73 x 47 mm) (WxHxD)
- Comply to Standards:  
IEC 60669  
GB 16915

## Typical connection method



Product Code	Colour
W2231	 White
W2231-SBL	 Matt Black (SBL)
W2231-ST	 Charcoal Black (ST)
W2231-MSB	 Matt Silver Black (MSB)
W2231-MSL	 Matt Silver (MSL)
<i>For other colours, please contact T&amp;J Sales representative</i>	

Adapter plate for Deco module					
Series	Product Code		3 gang adapter plate		
	1 gang adapter plate	2 gang adapter plate			
deco	W1111 	W1112A 	W1113 		
infinit	HC1231 	HC1232 			
HARMONY	EA1231 	EA1232 			
minimalist	EB1231 	EB1232 			
radiance	K1231-D 	K1201-D 			
Titanium	GC1231 	GC1221 			
Ultimate	G1231 	G1221 