

ORITZ LED TRACK LIGHT

Quality aluminum radiator, the optimum thermal path, reducing chip operating temperatures
Stylish, flexible architecture, rich lines for a variety of space

Ortiz
by **IMITOS**



Adaptor Main



2 Line circuit



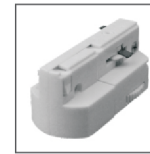

Adaptor optional

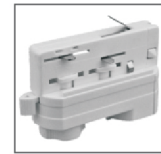

3 Line circuit



4 Line circuit

	CRI > 80Ra	AC 220-240V 50/60Hz	 24°	 3000K	 4000K	 6000K
---	---------------	---------------------------	---	---	---	---

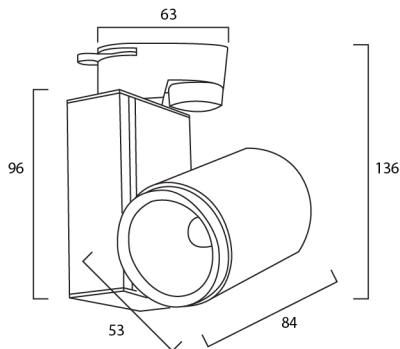

TR 35/9W

LED TRACK LIGHT

BLACK WHITE

Technical Parameters

- > Power : 9W
- > CCT : 3000K / 4000K / 6000K
- > LED Chip : CREE
- > Power Factor : >0.9
- > Lifetime : 50000h
- > Beam Angle : 24°
- > CRI : >80Ra
- > Power Requirement : 220-240V 50/60Hz
- > Lumen : 900-950lm
- > Dimmable : No

Photometric Diagram

