

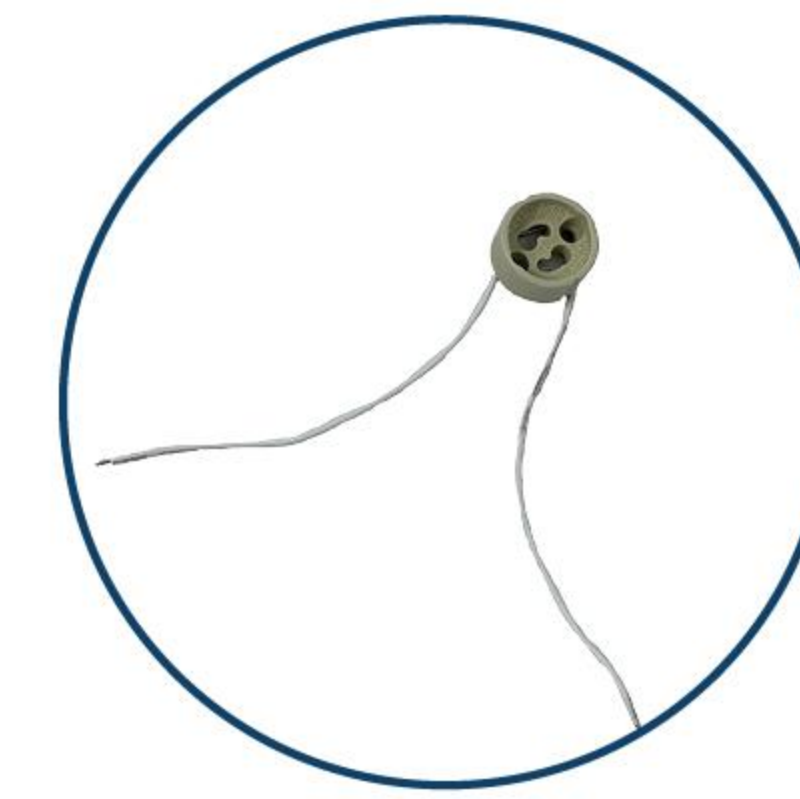

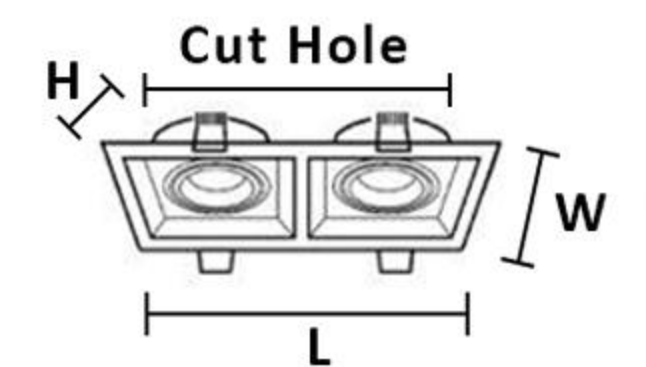









EYEBALL CASING

MESALED



■ With GU10 Holder



Product Image	Item Code	Model	Fitting Color	Dimensions (mm)
 	DSY016-SQ1	MESALED Die Cast Eyeball Fitting Square Single	Black + White	L100 x W100 x H40 Cut Hole : 85 x 85
 	DSY016-SQ2	MESALED Die Cast Eyeball Fitting Square Double	Black + White	L185 x W100 x H40 Cut Hole : 170 x 85
 	DSY026-SQ1	MESALED Metal Eyeball Fitting Square Single	Black White	L135 x H50 x W135 Cut Hole : 100 x 100
 	DSY026-SQ2	MESALED Metal Eyeball Fitting Square Double	Black White	L216 x H41 x W120 Cut Hole : 205 x 105
 	DSY026-SQ3	MESALED Metal Eyeball Fitting Square Triple	Black White	L334 x H35 x W136 Cut Hole : 300 x 105
 	DSY036-SQ2	MESALED Die Cast Eyeball Fitting Square Double	Black White	L210 x H41 x W120 Cut Hole : 200 x 100