

simon

E6

series



simon

E6

series

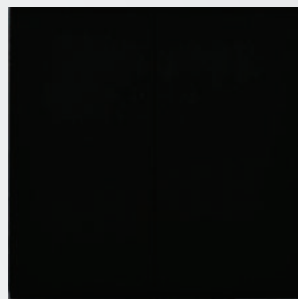
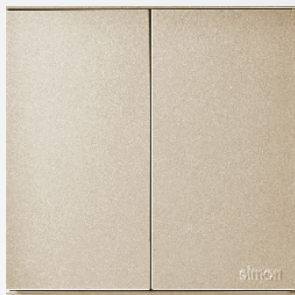

COLOURS

White, Champagne, Black

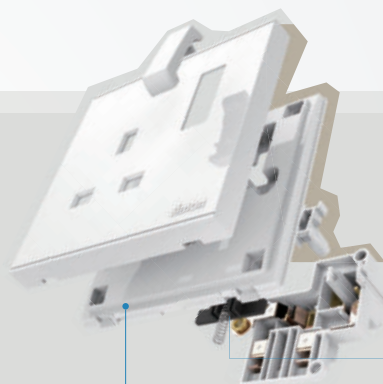

The design of compact protective doors and unilateral self-locks can effectively prevent children from inserting conductive objects into sockets.

Twinset configuration design (rocker + base plate)

Abandoning traditional configuration design (rocker + frame + Base plate) improves product strength, prolong lifespan and facilitate installation.

LARGE



86*82 SUPER LARGE PUSH-BUTTON
COMFORTABLE VISUAL IMPACT
BETTER VISUAL AND TOUCH

THIN

1.2mm
ULTRA-THIN
FRAMES

LIGHT AND COZY
VISUAL BEAUTY















86mm

INTEGRATED

ELEGANT AND MAGNIFICENT
SAY NO TO IRREGULARITY
ENSURE THE VISUAL COMFORT
(APPLICABLE TO STANDARD 86 BOTTOM BOX)

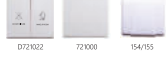

Switches	Item Code	Item Descriptions	
 	721011	16A 1 Gang 1 Way Switch	
	721012	16A 1 Gang 2 Way Switch	
	721021	16A 2 Gang 1 Way Switch	
	721022	16A 2 Gang 2 Way Switch	
	721031	16A 3 Gang 1 Way Switch	
	721032	16A 3 Gang 2 Way Switch	
	721041	10A 4 Gang 1 Way Switch	
	721042	10A 4 Gang 2 Way Switch	
	  	722023	20A 1 Gang 1 Way Double Pole Switch With Blue LED Indicator (Water Heater/Air Con)
		722024	20A 1 Gang 2 Way Double Pole Switch With Blue LED Indicator (Water Heater/Air Con)
723223		32A 1 Gang 1 Way Double Pole Switch With Blue LED Indicator (Water Heater/Air Con)	
723224		32A 1 Gang 2 Way Double Pole Switch With Blue LED Indicator (Water Heater/Air Con)	
721026		16A Intermediate Switch	
726301		16A 1 Gang Doorbell Switch	
721011F		16A 1 Gang Auto Gate Push Button / Momentary Switch	
721021F		16A 2 Gang Auto Gate Push Button / Momentary Switch	
 		721382	13A 1 Gang Flat Pin Switched Socket Outlet
		721582	15A 1 Gang Round Pin Switched Socket Outlet
	721089	13A Universal Switched Socket Outlet	
	72E725	10A Universal Socket Outlet with Double USB Charging Outlet (5V 2A)	
	721384	13A 1 Gang Flat Pin Switches Socket Outlet With Double USB Charging Outlet (5V 2A)	
	724583	13A Twin Socket Outlet	
		725111	1 Gang TV Outlet
		725114	1 Gang Broadband F-Connector (Astro) Outlet
725119		2 Gang TV Outlet & Broadband F-Connector (Astro) Outlet	
721120		SMATV Outlet	
  		725214	1 Gang Telephone Outlet (RJ11)
	725218	1 Gang Data Outlet Cat 5e (RJ45)	
	725618	1 Gang Data Outlet Cat 6 (RJ45)	
	725224	2 Gang Telephone Outlet (RJ11)	
	725228	2 Gang Data Outlet Cat 5e (RJ45)	
	725628	2 Gang Data Outlet Cat 6 (RJ45)	
	725229	2 Gang Telephone Outlet (RJ11) & Data Outlet Cat 5e (RJ45)	
	725629	2 Gang Telephone Outlet (RJ11) & Data Outlet Cat 6 (RJ45)	
	 	72E101	500W Rotary Dimmer (Incandescent Bulb)
		72E201	200VA Fan Speed Regulator
72E601		16A 250V Key Card Holder	
D721022		2 Gang 2 Way Switch with "Do Not Disturb" and "Make Up Room" Label	
721000		Blank Plate	
154		Weather proof cover for Switch	
155		Weather proof cover for Socket	

simon

SIMON Holdings (est. since 1916) is a worldwide holding company boasting the leading position in the low voltage electrical industry. With 12 production centers around the world, SIMON provides more than 3,500 varieties of product with sales network covering 55 countries. SIMON currently offers a wide range products including switches & sockets, LED lightings, lighting controls and many more .

E6 series

White



Champagne

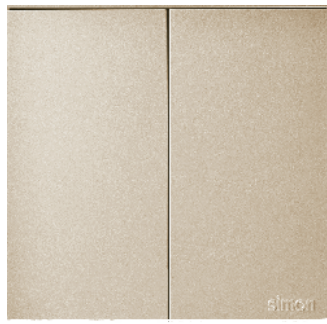

Black

