







Legend	Model
	<b>VES 625/B/RM</b> (Single Sided View)
	<b>VES 625/B/RML</b> (Double Sided View)
	<b>VES 625/B/RMR</b> (Single Sided View)
	<b>VES 625/BD/RM</b> (Double Sided View)
	<b>VES 625/BD/RMLRA</b> (Double Sided View)
	



### Specifications :

Polycarbonate Housing  
Polycarbonate Diffuser

### Test According to :

SS 563  
SS IEC 60598-2-22

### Mounting Method :

- Ceiling
- Wall

### Optional :

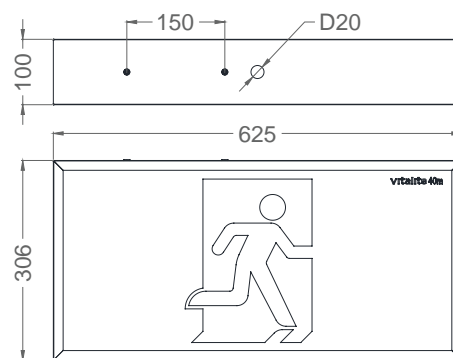

Mains Supply	220 – 240V 50/60Hz	Rating	0.01A / 3.15W / 0.95 PF
Mode of Operation	Maintained	Classification	Class 1
Lamp	LED 2835	Degree of Protection	IP 20
Battery	Ni-Cd AA 3.6V 900mAh	Max. Operating Temperature (ta)	40°C
Emergency Duration	2 Hours	Recommended Mounting Height	Min. 2.3m
Recharge Period	24 Hours	Weight	3.34 KG