



KLE1011

Linear LED Lighting for Hazardous Locations

-  II 2 G Ex emb IIC T6 Gb
-  II 2 D Ex tb IIIC T80°C Db IP66
- -40°C to 55°C Ambient Temperature
- ATEX-2014/34/EU
EN 60079-0:2012+A11:2013
EN 60079-7:2015
EN 60079-18:2015
EN 60079-31:2014
- EMC-2014/30/EU
- LVD-2014/35/EU
- RoHS-2011/65/EU
- IK10

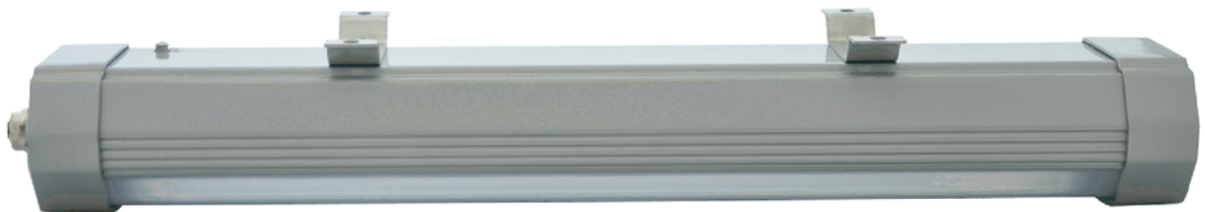

KLE1011

Linear LED Lighting for Hazardous Locations

Key Features:

- 1 Low-profile, lightweight design, high quality aluminum housing
- 2 Impact resistant diffused lens with Bayer original material
- 3 Stainless steel bracket for ceiling mount
- 4 Professional light distribution, uniform illumination through the entire space
- 5 With single-ended feedthrough or double-ended feedthrough optional



Additional Features:

- Standard 6-12KV surge protection
- Feed-through capable
- Enclosures attached to back brackets for pendant pole mount, pendant chain mount and 45 degree wall mount.
- Clear lens option
- 3-year warranty

Standard Materials:

- Body: 6063 aluminum (less than 0.4% copper content) with grey-painted or yellow-painted finish options.
- Side cover: ADC12
- Gaskets: one-piece neoprene
- Brackets: stainless steel
- Lens: polycarbonate

Features & Benefits:

- 1 Environmentally Friendly 50,000 hrs lifetime
- 2 Superior color rendering index compared to HPS, LPS or MV
- 3 Low temperature applications to -40°C and high temperature up to 55°C
- 4 Best-in-class efficacy-Up to 110 lumens per watt
- 5 Professional light distribution design, uniform and comfortable lighting
- 6 Temperature compensation technology for longer life
- 7 Low maintenance costs and power consumption reduced by over 50%

KLE1011

Linear LED Lighting for Hazardous Locations

Catalog Number Logic

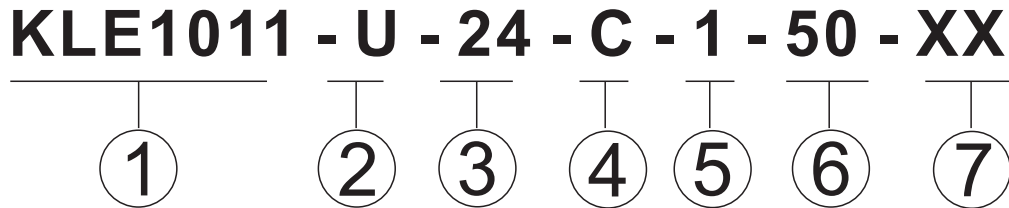

1 BASIC SERIES

2 VOLTAGE/FREQUENCY
U=90-305V 50/60Hz

3 LAMP WATTAGE
24=24 Watt
36=36 Watt
50=50 Watt
60=60 Watt
72=72 Watt
80=80 Watt

4 LENS
C=Clear
D=Diffused

5 NORMAL FIXTURE LENGTH
1=300mm
2=600mm
4=1200mm

6 CCT
60=6000K CCT
50=5000K CCT (recommend)
40=4000K CCT

7 OPTIONS
PP= Pendant Pole Mount
PC= Pendant Chain Mount
CA= Ceiling Mount A
CB= Ceiling Mount B
WA= Wall Mount A
WB= Wall Mount B
BC= Beam Clamp Mount
PM= Pole Mount

Mounting Hardware not include. Please see options for mounting selections.

Catalog logic is for explaining catalog number structure only.
Not all combinations are possible; consult factory for catalog numbers not listed in charts.

KLE1011

Linear LED Lighting for Hazardous Locations

Certification Guide

Model	Length	Wattage	Operating Voltage	Total Lumens	Lumen per Watt	CRI	CCT *	Ambient Temperature	Ex-mark for Gas	Ex-mark for Dust	Supply Wire Suitable Temperature
KLE1011U24C1	385mm	24W	90-305V 50/60Hz	2712	113	75	5034	-40°C<Tamb<55°C	Ex II 2 G Ex emb IIC T6 Gb	Ex II 2 D Ex tb IIIC T80°C Db IP66	80°C
KLE1011U36C2	685mm	36W	90-305V 50/60Hz	4212	117	75	5021	-40°C<Tamb<55°C	Ex II 2 G Ex emb IIC T6 Gb	Ex II 2 D Ex tb IIIC T80°C Db Ip66	80°C
KLE1011U50C4	1285mm	50W	90-305V 50/60Hz	6250	125	75	5046	-40°C<Tamb<55°C	Ex II 2 G Ex emb IIC T6 Gb	Ex II 2 D Ex tb IIIC T80°C Db Ip66	80°C
KLE1011U60C4	1285mm	60W	90-305V 50/60Hz	7380	123	75	5038	-40°C<Tamb<55°C	Ex II 2 G Ex emb IIC T6 Gb	Ex II 2 D Ex tb IIIC T80°C Db Ip66	80°C
KLE1011U72C4	1285mm	72W	90-305V 50/60Hz	8424	117	74	5023	-40°C<Tamb<55°C	Ex II 2 G Ex emb IIC T6 Gb	Ex II 2 D Ex tb IIIC T80°C Db Ip66	80°C
KLE1011U80C4	1285mm	80W	90-305V 50/60Hz	9120	114	75	5020	-40°C<Tamb<55°C	Ex II 2 G Ex emb IIC T6 Gb	Ex II 2 D Ex tb IIIC T80°C Db Ip66	80°C
KLE1011U24D1	385mm	24W	90-305V 50/60Hz	2280	95	75	5034	-40°C<Tamb<55°C	Ex II 2 G Ex emb IIC T6 Gb	Ex II 2 D Ex tb IIIC T80°C Db Ip66	80°C
KLE1011U36D2	685mm	36W	90-305V 50/60Hz	3456	96	75	5021	-40°C<Tamb<55°C	Ex II 2 G Ex emb IIC T6 Gb	Ex II 2 D Ex tb IIIC T80°C Db Ip66	80°C
KLE1011U50D4	1285mm	50W	90-305V 50/60Hz	5250	105	75	5052	-40°C<Tamb<55°C	Ex II 2 G Ex emb IIC T6 Gb	Ex II 2 D Ex tb IIIC T80°C Db Ip66	80°C
KLE1011U60D4	1285mm	60W	90-305V 50/60Hz	6180	103	75	5012	-40°C<Tamb<55°C	Ex II 2 G Ex emb IIC T6 Gb	Ex II 2 D Ex tb IIIC T80°C Db Ip66	80°C
KLE1011U72D4	1285mm	72W	90-305V 50/60Hz	6912	96	74	5023	-40°C<Tamb<55°C	Ex II 2 G Ex emb IIC T6 Gb	Ex II 2 D Ex tb IIIC T80°C Db Ip66	80°C
KLE1011U80D4	1285mm	80W	90-305V 50/60Hz	7600	95	75	5026	-40°C<Tamb<55°C	Ex II 2 G Ex emb IIC T6 Gb	Ex II 2 D Ex tb IIIC T80°C Db Ip66	80°C

* All values typical unless otherwise stated (tolerance +/- 10%)

Photometric Data

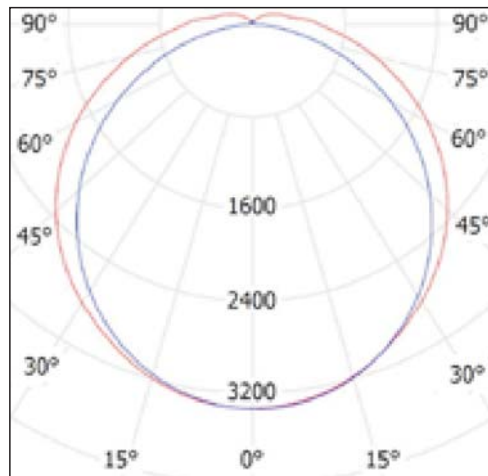

Fixture Dimensions(mm)

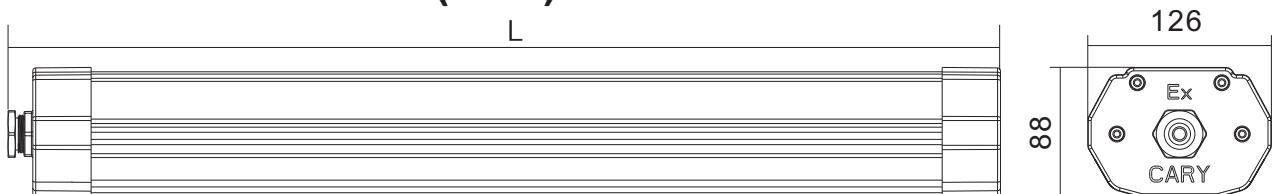

KLE1011 Series	Dimensions(mm)	Net Weight(kg)	Boxed Weight(kg)	Shipping Volume(m ²)
300mm models	L=385	2.6	3.0	0.014
600mm models	L=685	3.8	4.6	0.024
1200mm models	L=1285	6.8	8.0	0.043

KLE1011

Linear LED Lighting for Hazardous Locations

Accessories

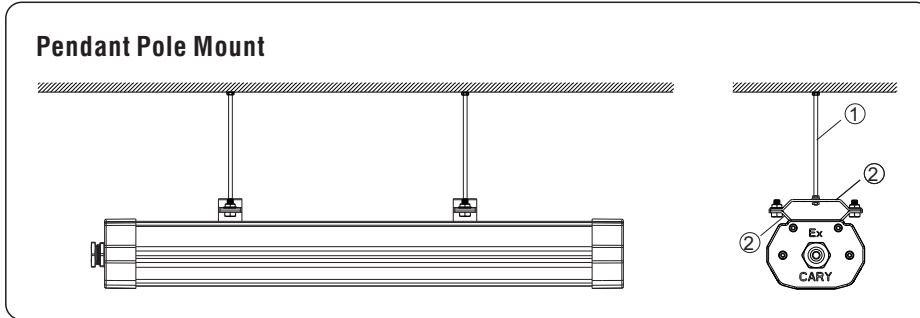

Pendant Pole Mount
 Catalog Number: 1011001
 Qty: 1 kit
 Shipping Weight: 0.64 kg/kit

Mounting Type	Ordering	Part SN	Part Name	Ordering	Part Qty.	Material	Weight(kg/pcs)
Pendant Pole Mount	1011001	①	M8 Screw Pole(L=500MM)	1011009	2	SUS304	0.2
		②	Bracket	1011008	4	SUS304	0.06

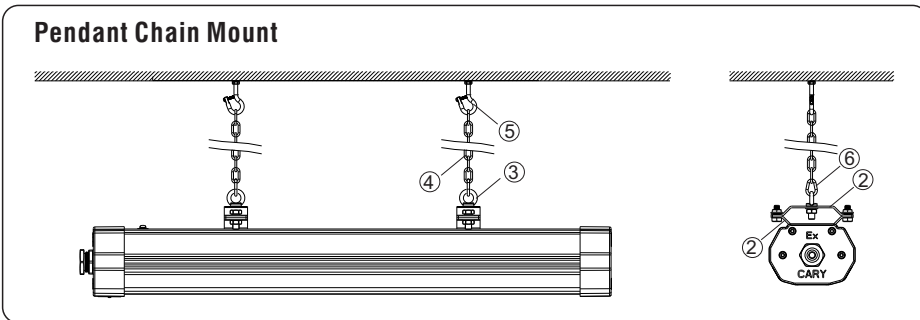

Pendant Chain Mount
 Catalog Number: 1011002
 Qty: 1 kit
 Shipping Weight: 0.66 kg/kit

Mounting Type	Ordering	Part SN	Part Name	Ordering Code	Part Qty.	Material	Weight(kg/pcs)
Pendant Chain Mount	1011002	②	Bracket	1011008	4	SUS304	0.06
		③	Lifting Bolt	1011010	2	SUS304	0.03
		④	Pendant Chain	1011011	2	SUS304	0.1
		⑤	Expansion Hook	1011012	2	SUS304	0.06
		⑥	Hanging buckle	1011013	2	SUS304	0.02

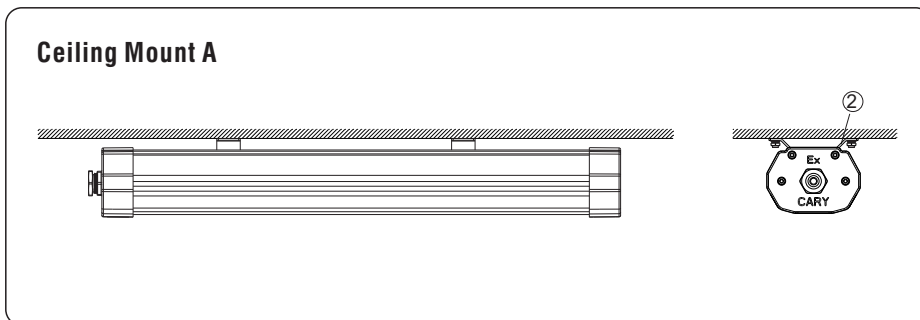

Ceiling Mount A
 Catalog Number: 1011003
 Qty: 1 kit
 Shipping Weight: 0.12 kg/kit

Mounting Type	Ordering Code	Part SN	Part Name	Ordering Code	Part Qty.	Material	Weight(kg/pcs)
Ceiling Mount A	1011003	②	Bracket	1011008	2	SUS304	0.06

KLE1011

Linear LED Lighting for Hazardous Locations

Ceiling Mount B (adjustable angles)

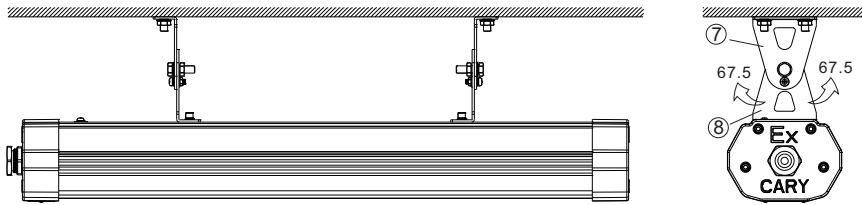

Ceiling Mount B

Catalog Number: 1011004

Qty: 1 kit

Shipping Weight: 0.48 kg/kit

Mounting Type	Ordering	Part SN	Part Name	Ordering Code	Part Qty.	Material	Weight(kg/pcs)
Ceiling Mount B (adjustable angles)	1011004	⑦	Bracket	1011014	2	SUS304	0.12
		⑧	Bracket	1011015	2	SUS304	0.12

Wall Mount A

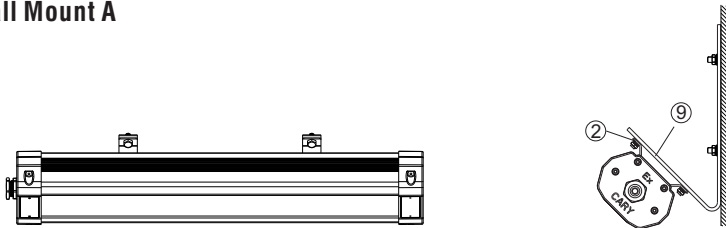

Wall Mount A

Catalog Number: 1011005

Qty: 1 kit

Shipping Weight: 0.28 kg/kit

Mounting Type	Ordering Code	Part SN	Part Name	Ordering Code	Part Qty.	Material	Weight(kg/pcs)
Wall Mount A	1011005	⑨	V-Shape Bracket	1011016	2	SUS304	0.08
		②	Bracket	1011008	2	SUS304	0.06

Wall Mount B (adjustable angles)

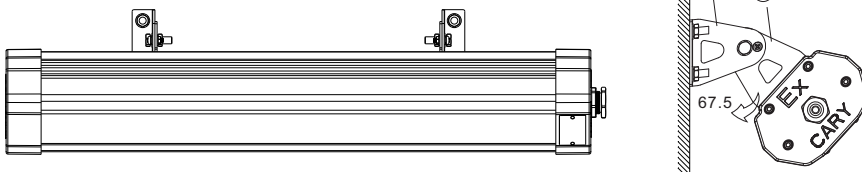

Wall Mount B

Catalog Number: 1011004

Qty: 1 kit

Shipping Weight: 0.48 kg/kit

Mounting Type	Ordering	Part SN	Part Name	Ordering Code	Part Qty.	Material	Weight(kg/pcs)
Ceiling Mount B (adjustable angles)	1011004	⑦	Bracket	1011014	2	SUS304	0.12
		⑧	Bracket	1011015	2	SUS304	0.12

KLE1011

Linear LED Lighting for Hazardous Locations

Beam Clamp Mount

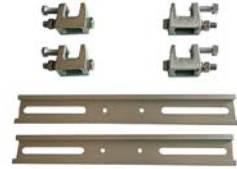
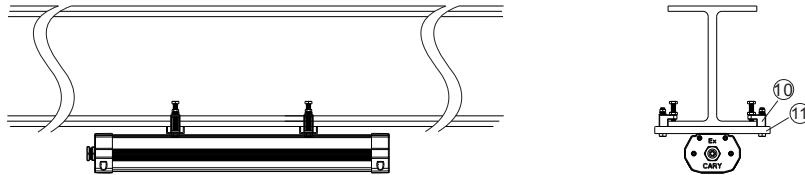

Beam Clamp Mount

Catalog Number: 1011006

Qty: 1 kit

Shipping Weight: 0.64 kg/kit

Mounting Type	Ordering	Part SN	Part Name	Ordering Code	Part Qty.	Material	Weight(kg/pcs)
Beam Clamp Mount	1011006	⑩	Beam Clamp	1011017	4	SUS304	0.12
		⑪	Aluminum Groove *	1011018	2	6063	0.08

* Suitable for steel I-beam with 4.33-8.26 inches width.

Pole Mount

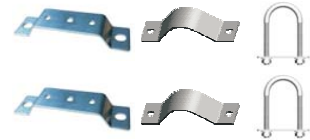
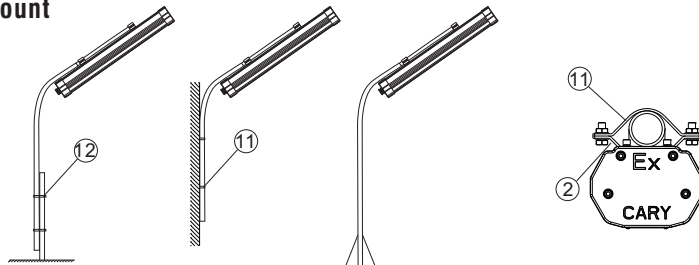

Pole Mount

Catalog Number: 1011007

Qty: 1 kit

Shipping Weight: 0.34 kg/kit

Mounting Type	Ordering Code	Part SN	Part Name	Ordering	Part Qty.	Material	Weight(kg/pcs)
Pole Mount	1011007	⑫	Bracket	1011008	2	SUS304	0.06
		⑬	Hoop	1011019	2	SUS304	0.05
		⑭	U-Shape Pipe Clamp	1011020	2	SUS304	0.06