

Backpack for  
Total Station

# M-RBP2 / M-RBPS

**NEW** **M-RBPS** *Compact type*

*Compact size for easy carrying,  
yet with great cushioning.*



Freestanding backpack M-RBP series have developed to carry a burden safely and lightly. It has 12 cushions for the safety, and padded shoulder straps and waist straps make you feel lighter than the actual weight. Your two choices are **M-RBP2** that has excellent stability with the light aluminium frame, or **M-RBPS** that is excellent in lightness and mobility.

**M-RBP2**

# Backpack for Total Station M-RBP2/M-RBPS

## Feature 1

Suitable for almost all instruments



## Feature 2

Suspension system by waist belt

## Feature 3

Hands free by backpack style

## Feature 4

High capacity & Pockets

### Flap

Flap protects from entering water or dew.



### High Cushioning

6 removable cushions can adjust the inside dimensions.  
Fixed 6 + Removable 6 = 12



### Double Belts

Double belts brings double sense of safety.



### Reflector

Reflectors on back of the bag will help you stand out in the dark.

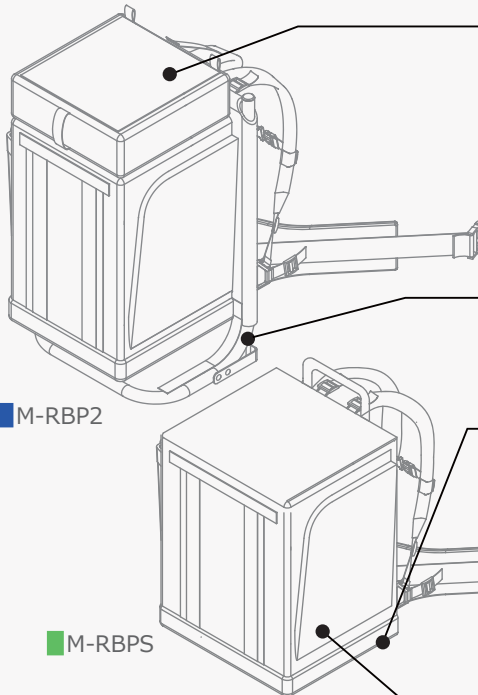
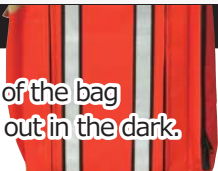

### Removable Top Case

High capacity case for accessories.  
ex. Prisms, Fields books



### Freestanding

Aluminium frame gives it excellent stability, and keep it light.

Freestanding without frame. Able to put directly on the ground with four durable PP traction pad.



### Side Pockets

Large pockets on both sides of the bag. Notebooks, tablet, and bottles etc. are containable.

\* No cushion

### Pen pocket

\* M-RBPS only

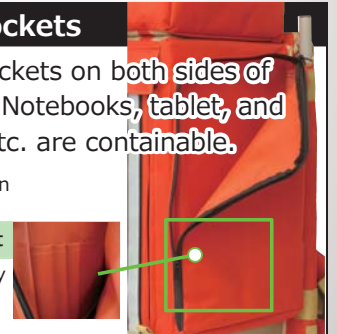

### Water-shedding fabric

Water-shedding fabric does not let drops of dew soak through easily.

\* Non-waterproof

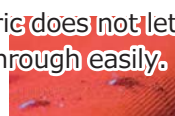

## Specifications

	M-RBP2	M-RBPS
Dimension	400 × 350 × 650mm	300 × 300 × 500mm
Weight	approx. 3.5kg	approx. 2.5kg

### Inner Dimension

(both M-RBP2 and M-RBPS)

\* Dimension is rough estimate  
\* ( ) is added cushioning properties

with Cushions

without Cushions

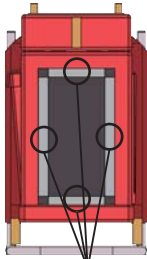

Cushions

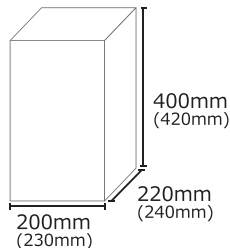
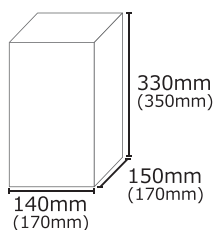

## Option

for M-RBP2

### Water-resistant Rain Cover RBP-WP

- Drawstring
- Waterproof tape



Code No.	Product Name	Model
221825	Backpack for Total Station - Regular	M-RBP2
221510	Backpack for Total Station - Compact	M-RBPS
221499	Water-resistant Rain Cover	RBP-WP

# Myzox Co., Ltd.

401 Yamagoe, Nagakute, Aichi 480-1111 Japan  
TEL : +81-561-64-2210 FAX : +81-561-63-7770

[www.myzoxjapan.com](http://www.myzoxjapan.com)

Your Local Authorized Myzox Dealer is :