

Product Price Guide  
&  
*catalog*

2022 (ver 7.1 Nov)



CABLE LUG



ReyLuc



From PAGE 4 页起

TOOLS



From PAGE 15 页起

NEM-CEE



CEE Twislok

From PAGE 21 页起

LIMIT SWITCH



From PAGE 29 页起

WARNING

NANZHOU 南洲

From PAGE 34 页起

METERS



From PAGE 37 页起

WEATHERPROOF



From PAGE 47 页起

TIMER



From PAGE 52 页起



铜管接线端子

LUGS & TERMINALS

CONNECTOR



CRIMPING TOOLS

PIPE TOOLS 导管工具



CEE 防水插头/插座

PLUG & SOCKET



LIMIT-MICRO SWITCH

CONTROL BUTTON



WARNING LIGHT - SIREN - ALARM BELL



DIGITAL METERS 数字仪表



WEATHERPROOF SWITCH SOCKET



USB SWITCH SOCKET

COVER

TIMER

DOORBELL



Page 5 & 6 页



Page 7 页



Page 8 页



Page 9 页



Page 9 页



Page 9 页



Page 10 页



Page 10 页



Page 10 页



Page 10 页



Page 11 页



Page 11 页



Page 11 页



Page 11 页



Page 12 页



Page 12 页



Page 13 页



Page 13 页



Page 13 页

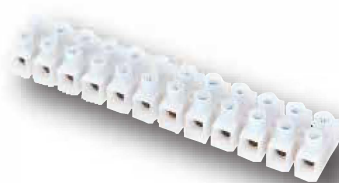

Page 14 页



Page 14 页



Page 14 页



Page 14 页





Cable Size 电线规格(mm <sup>2</sup> )	Stud Hole Size 螺丝孔直径(M)	Item Code 型号	Qty/box 每小盒数量 (pcs)	List Price 大价 (RM/100pcs)
1.5mm <sup>2</sup>	M5 (3/16")	RC1.5-5	5,000	14.50
1.5mm <sup>2</sup>	M6 (1/4")	RC1.5-6	5,000	14.50
2.5mm <sup>2</sup>	M5 (3/16")	RC2.5-5	4,000	20.00
2.5mm <sup>2</sup>	M6 (1/4")	RC2.5-6	4,000	20.00
2.5mm <sup>2</sup>	M8 (5/16")	RC2.5-8	4,000	33.00
4mm <sup>2</sup>	M5 (3/16")	RC4-5	3,000	25.00
4mm <sup>2</sup>	M6 (1/4")	RC4-6	3,000	25.00
4mm <sup>2</sup>	M8 (5/16")	RC4-8	3,000	30.00
6mm <sup>2</sup>	M6 (1/4")	RC6-6	1,800	36.00
6mm <sup>2</sup>	M8 (5/16")	RC6-8	1,800	39.00
6mm <sup>2</sup>	M10 (3/8")	RC6-10	1,800	55.00
10mm <sup>2</sup>	M6 (1/4")	RC10-6	1,800	45.00
10mm <sup>2</sup>	M8 (5/16")	RC10-8	1,800	45.00
10mm <sup>2</sup>	M10 (3/8")	RC10-10	1,800	57.00
16mm <sup>2</sup>	M6 (1/4")	RC16-6	1,000	68.00
16mm <sup>2</sup>	M8 (5/16")	RC16-8	1,000	60.00
16mm <sup>2</sup>	M10 (3/8")	RC16-10	1,000	62.00
16mm <sup>2</sup>	M12 (1/2")	RC16-12	1,000	80.00
25mm <sup>2</sup>	M6 (1/4")	RC25-6	700	110.00
25mm <sup>2</sup>	M8 (5/16")	RC25-8	700	103.00
25mm <sup>2</sup>	M10 (3/8")	RC25-10	700	103.00
25mm <sup>2</sup>	M12 (1/2")	RC25-12	700	103.00
35mm <sup>2</sup>	M6 (1/4")	RC35-6	500	155.00
35mm <sup>2</sup>	M8 (5/16")	RC35-8	500	148.00
35mm <sup>2</sup>	M10 (3/8")	RC35-10	500	142.00
35mm <sup>2</sup>	M12 (1/2")	RC35-12	500	148.00
35mm <sup>2</sup>	M16 (5/8")	RC35-16	500	170.00
50mm <sup>2</sup>	M8 (5/16")	RC50-8	300	225.00
50mm <sup>2</sup>	M10 (3/8")	RC50-10	300	208.00
50mm <sup>2</sup>	M12 (1/2")	RC50-12	300	215.00
70mm <sup>2</sup>	M8 (5/16")	RC70-8	150	370.00
70mm <sup>2</sup>	M10 (3/8")	RC70-10	150	360.00
70mm <sup>2</sup>	M12 (1/2")	RC70-12	150	340.00
70mm <sup>2</sup>	M16 (5/8")	RC70-16	150	380.00
95mm <sup>2</sup>	M8 (5/16")	RC95-8	100	550.00
95mm <sup>2</sup>	M10 (3/8")	RC95-10	100	550.00
95mm <sup>2</sup>	M12 (1/2")	RC95-12	100	525.00
95mm <sup>2</sup>	M16 (5/8")	RC95-16	100	550.00
120mm <sup>2</sup>	M10 (3/8")	RC120-10	90	725.00
120mm <sup>2</sup>	M12 (1/2")	RC120-12	90	715.00
120mm <sup>2</sup>	M16 (5/8")	RC120-16	90	725.00
150mm <sup>2</sup>	M8 (5/16")	RC150-8	80	1030.00
150mm <sup>2</sup>	M10 (3/8")	RC150-10	80	1000.00
150mm <sup>2</sup>	M12 (1/2")	RC150-12	80	1000.00
150mm <sup>2</sup>	M16 (5/8")	RC150-16	80	940.00

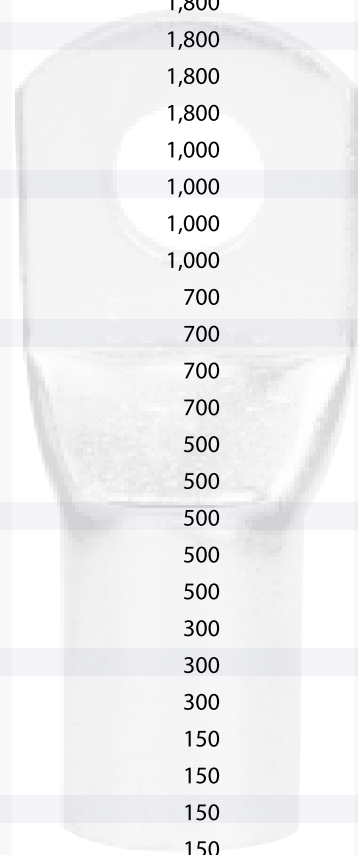
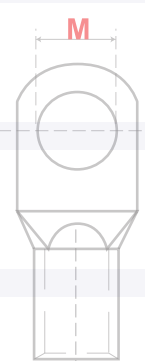
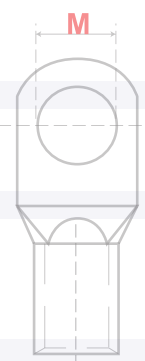

\* Common Size in Highlight  
\* 突出显示的文字为通用型号  
Crimping Tool 适用工具 Page 16 页





Cable Size 电线规格(mm <sup>2</sup> )	Stud Hole Size 螺丝孔直径(M)	Item Code 型号	Qty/box 每小盒数量 (pcs)	List Price 大价 (RM/100pcs)
185mm <sup>2</sup>	M10 (3/8")	<b>RC185-10</b>	50	<b>1,350.00</b>
185mm <sup>2</sup>	M12 (1/2")	<b>RC185-12</b>	50	<b>1,350.00</b>
185mm <sup>2</sup>	M14 (1/2")	<b>RC185-14</b>	50	<b>1,500.00</b>
185mm <sup>2</sup>	M16 (5/8")	<b>RC185-16</b>	50	<b>1,290.00</b>
240mm <sup>2</sup>	M12 (1/2")	<b>RC240-12</b>	40	<b>2,050.00</b>
240mm <sup>2</sup>	M16 (5/8")	<b>RC240-16</b>	40	<b>1,900.00</b>
300mm <sup>2</sup>	M12 (1/2")	<b>RC300-12</b>	30	<b>3,250.00</b>
300mm <sup>2</sup>	M16 (5/8")	<b>RC300-16</b>	30	<b>2,900.00</b>
400mm <sup>2</sup>	M12 (1/2")	<b>RC400-12</b>	15	<b>4,600.00</b>
400mm <sup>2</sup>	M16 (5/8")	<b>RC400-16</b>	15	<b>4,300.00</b>
500mm <sup>2</sup>	M16 (5/8")	<b>RC500-16</b>	10	<b>6,500.00</b>
500mm <sup>2</sup>	M20 (3/4")	<b>RC500-20</b>	10	<b>6,100.00</b>
630mm <sup>2</sup>	M20 (3/4")	<b>RC630-20</b>	8	<b>9,000.00</b>

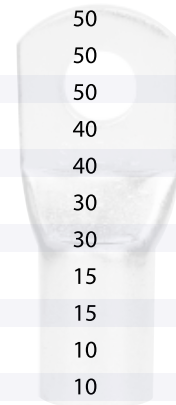
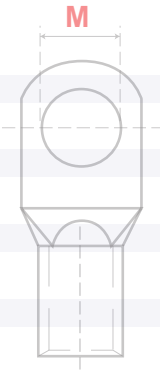

\* Common Size in Highlight  
\* 突出显示的文字为通用型号

**Crimping Tool 适用工具 Page 16 页**

### ReyLuc Cable Link

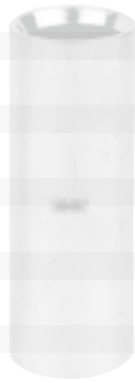

Cable Size 电线规格(mm <sup>2</sup> )	Item Code 型号	Qty/box 每小盒数量 (pcs)	List Price 大价 (RM/100pcs)
1.5mm <sup>2</sup>	<b>RL1.5</b>	5,000	<b>21.00</b>
2.5mm <sup>2</sup>	<b>RL2.5</b>	4,000	<b>26.00</b>
4mm <sup>2</sup>	<b>RL4</b>	3,000	<b>35.00</b>
6mm <sup>2</sup>	<b>RL6</b>	2,500	<b>44.00</b>
10mm <sup>2</sup>	<b>RL10</b>	1,500	<b>66.00</b>
16mm <sup>2</sup>	<b>RL16</b>	700	<b>88.00</b>
25mm <sup>2</sup>	<b>RL25</b>	400	<b>130.00</b>
35mm <sup>2</sup>	<b>RL35</b>	300	<b>190.00</b>
50mm <sup>2</sup>	<b>RL50</b>	200	<b>260.00</b>
70mm <sup>2</sup>	<b>RL70</b>	150	<b>385.00</b>
95mm <sup>2</sup>	<b>RL95</b>	100	<b>575.00</b>
120mm <sup>2</sup>	<b>RL120</b>	90	<b>800.00</b>
150mm <sup>2</sup>	<b>RL150</b>	80	<b>1,100.00</b>
185mm <sup>2</sup>	<b>RL185</b>	50	<b>1,500.00</b>
240mm <sup>2</sup>	<b>RL240</b>	30	<b>2,100.00</b>
300mm <sup>2</sup>	<b>RL300</b>	25	<b>3,000.00</b>
400mm <sup>2</sup>	<b>RL400</b>	15	<b>4,200.00</b>
500mm <sup>2</sup>	<b>RL500</b>	10	<b>6,100.00</b>
630mm <sup>2</sup>	<b>RL630</b>	8	<b>9,300.00</b>



**Crimping Tool 适用工具 Page 16 页**





Type 款型	Cable Size 电线规格(mm <sup>2</sup> )	Dimension 尺寸(mm)		Item Code 型号	Qty/box 每小盒数量 (pcs)	List Price 大价 (RM/100pcs)
		W	d			
<b>Insulated Y-型绝缘端子</b>						
	1.5mm <sup>2</sup>	5.7	3.2	VF1.25-3YSA	3,500	10.50
		5.7	3.7	VF1.25-3YS	3,500	10.50
		6.4	4.3	VF1.25-4YS	3,500	11.30
		8.0	5.3	VF1.25-5Y	3,000	11.50
		10.7	6.7	VF1.25-6Y	2,500	15.00
	2.5mm <sup>2</sup>	5.7	3.2	VF2-3YSA	3,000	12.00
		5.7	3.7	VF2-3YS	3,000	12.00
		6.4	4.3	VF2-4YS	3,000	13.00
		8.0	5.3	VF2-5Y	3,000	14.00
		10.7	6.7	VF2-6Y	2,000	18.00
	4 - 6mm <sup>2</sup>	14.0	8.4	VF2-8Y	1,000	34.00
		8.2	3.7	VF5.5-3YS	1,200	27.00
		8.2	4.3	VF5.5-4Y	1,000	28.00
		9.0	5.3	VF5.5-5Y	1,000	29.00
		12.0	6.4	VF5.5-6Y	1,000	33.00
		14.0	8.4	VF5.5-8Y	800	51.00

Crimping Tool 适用工具 (HS-30J) Page 17 页



## 非绝缘Y-型 Non-Insulated Spade Terminals (Y-Lug)

Type 款型	Cable Size 电线规格(mm <sup>2</sup> )	Dimension 尺寸 (mm)		Item Code 型号	Qty/box 每小盒数量 (pcs)	List Price 大价 (RM/100pcs)
		W	d			
	1.5mm <sup>2</sup>	5.7	3.7	1.25-3YS	9,000	9.50
		6.4	4.3	1.25-4YS	8,000	10.30
		8.0	5.3	1.25-5Y	5,000	14.00
		10.7	6.7	1.26-6Y	3,500	17.00
		5.7	3.7	2-3YS	6,500	11.50
2.5mm <sup>2</sup>	6.4	4.3	2-4YS	6,000	12.00	
	8.0	5.3	2-5Y	6,000	13.00	
	10.7	6.7	2-6Y	3,000	19.00	
4 - 6mm <sup>2</sup>	8.2	3.7	5.5-3Y	2,000	30.00	
	8.2	4.3	5.5-4Y	2,000	30.00	
	9.0	5.3	5.5-5Y	2,000	31.00	
	12.0	6.4	5.5-6Y	1,500	41.00	

Crimping Tool 适用工具 (HS-101) Page 17 页



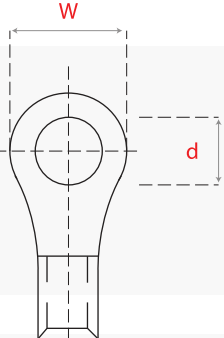
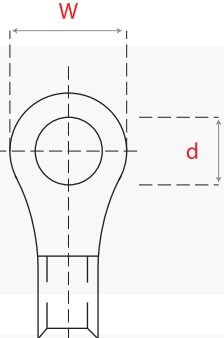

Type 款型	Cable Size 电线规格(mm <sup>2</sup> )	Dimension 尺寸 (mm)		Item Code 型号	Qty/box 每小盒数量 (pcs)	List Price 大价 (RM/100pcs)		
<b>Insulated 圆型绝缘</b>								
	1.5mm <sup>2</sup>	<b>W</b>	<b>d</b>					
		5.5	3.2	<b>VF1.25-3A</b>	3,500	9.00		
		5.5	3.7	<b>VF1.25-3</b>	3,500	9.00		
		8.0	4.3	<b>VF1.25-4</b>	3,500	12.00		
		6.6	4.3	<b>VF1.25-4M</b>	3,500	11.00		
		8.0	5.3	<b>VF1.25-5</b>	3,000	13.00		
		11.6	6.4	<b>VF1.25-6</b>	2,500	19.00		
		11.6	8.4	<b>VF1.25-8</b>	2,000	19.00		
		13.6	10.5	<b>VF1.25-10</b>	2,000	31.00		
			2.5mm <sup>2</sup>	6.6	3.7	<b>VF2-3M</b>	3,000	13.00
8.5	4.3			<b>VF2-4</b>	3,000	16.00		
6.6	4.3			<b>VF2-4M</b>	3,000	13.00		
9.5	5.3			<b>VF2-5</b>	2,500	16.50		
12.0	6.4			<b>VF2-6</b>	2,000	23.00		
12.0	8.4			<b>VF2-8</b>	2,000	24.00		
13.6	10.5			<b>VF2-10</b>	2,000	31.00		
	4 - 6mm <sup>2</sup>			7.2	3.7	<b>VF5.5-3</b>	1,000	33.00
				9.5	4.3	<b>VF5.5-4</b>	1,000	33.00
				9.5	5.3	<b>VF5.5-5</b>	1,000	33.00
		12.0	6.4	<b>VF5.5-6S</b>	1,000	38.00		
		15.0	8.4	<b>VF5.5-8</b>	1,000	45.00		
		15.0	10.5	<b>VF5.5-10</b>	1,000	45.00		
		18.2	13.2	<b>VF5.5-12</b>	800	48.00		
<b>Non-insulated 非绝缘</b>								
	1.5mm <sup>2</sup>	5.5	3.7	<b>1.25-3</b>	5,000	11.50		
		6.6	4.3	<b>1.25-4M</b>	7,000	10.00		
		8.0	5.3	<b>1.25-5</b>	7,000	11.00		
		11.6	6.4	<b>1.25-6</b>	5,000	23.00		
		11.6	8.4	<b>1.25-8</b>	3,000	23.00		
		13.6	10.5	<b>1.25-10</b>	2,000	30.00		
		18.0	13.0	<b>1.25-12</b>	1,000	35.00		
			2.5mm <sup>2</sup>	6.6	3.7	<b>2-3M</b>	6,500	14.00
				6.6	4.3	<b>2-4M</b>	6,500	12.00
				9.5	5.3	<b>2-5</b>	6,000	16.00
12.0	6.4			<b>2-6</b>	4,000	20.00		
12.0	8.4			<b>2-8</b>	4,000	21.00		
13.6	10.5			<b>2-10</b>	3,000	29.00		
	4 - 6mm <sup>2</sup>	19.2	13.0	<b>2-12</b>	3,000	36.00		
		9.5	3.7	<b>5.5-3</b>	3,000	31.00		
		9.5	4.3	<b>5.5-4</b>	3,000	29.00		
		9.5	5.3	<b>5.5-5</b>	3,000	32.00		
		12.0	6.4	<b>5.5-6S</b>	3,000	34.00		
		15.0	8.4	<b>5.5-8</b>	2,000	46.00		
		15.0	10.5	<b>5.5-10</b>	2,000	43.00		
		19.2	13.0	<b>5.5-12</b>	1,000	64.00		
			10.0mm <sup>2</sup>	10.0	4.3	<b>LY8-4</b>	500	80.00
			16.0mm <sup>2</sup>	22.0	13.0	<b>LY12-16</b>	500	250.00







Type 款型	Cable Size 电线规格(mm <sup>2</sup> )	Dimension 尺寸 (mm)			Item Code 型号	Qty/box 每小盒数量 (pcs)	List Price 大价 (RM/100pcs)		
		W	F	T					
<b>Male 公</b>									
	1.5mm <sup>2</sup>		2.8	6.5	0.5	RM110-5	3,000	17.60	
			2.8	6.5	0.8	RM110-8	3,000	17.60	
			4.5	6.5	0.5	RM187-5	3,000	17.60	
	2.5mm <sup>2</sup>		6.3	7.7	0.8	RM250	3,000	16.50	
			2.8	6.5	0.5	BM110-5	3,000	17.60	
			4.5	6.5	0.5	BM187-5	3,000	18.70	
	4 - 6mm <sup>2</sup>		6.3	7.7	0.8	YM250	2,000	20.00	
			6.3	7.7	0.8				
<b>Female 母</b>									
	1.5mm <sup>2</sup>		3.2	6.5	0.3	RF110-5	3,000	19.60	
			5.0	6.4	0.3	RF187-5	3,000	19.60	
			5.0	6.4	0.4	RF187-8	3,000	19.60	
	2.5mm <sup>2</sup>		6.6	7.3	0.4	RF250	3,000	18.00	
			3.2	6.5	0.3	BF110-5	3,000	19.60	
			5.0	6.4	0.3	BF187-5	3,000	19.60	
	4 - 6mm <sup>2</sup>		5.0	6.4	0.4	BF187-8	3,000	19.60	
			6.6	7.3	0.4	BF250	2,500	18.00	
	1.5mm <sup>2</sup>		6.6	7.3	0.4	YF250	1,500	21.00	
			6.6	7.3	0.4				
			6.6	7.3	0.4				
<b>Female 全绝缘插鞘母端子</b>									
	1.5mm <sup>2</sup>		3.2	6.5	0.3	RF110F-5	2,000	26.00	
			5.0	6.4	0.4	RF187F-5	2,000	26.00	
			6.6	7.3	0.4	RF250F	1,500	25.00	
	2.5mm <sup>2</sup>		3.2	6.5	0.3	BF110F-5	2,000	26.00	
			5.0	6.4	0.4	BF187F-5	2,000	26.00	
			6.6	7.3	0.4	BF250F	1,500	26.00	
	4 - 6mm <sup>2</sup>		6.6	7.3	0.4	YF250F	1,000	34.00	
			6.6	7.3	0.4				
<b>Open Barrel (M/F) 平網公母端子</b>									
Male 公		Female 母		6.0	15.6		1661-BS-0	3,000	23.00
				7.4	7.5		1764-BS-0	3,000	21.00
				7.4	7.5		1761-BS-0	3,000	23.00

Crimping Tool 适用工具 Page 17 页





Type 款型	Cable Size 电线规格(mm <sup>2</sup> )	Dimension 尺寸(mm)		Item Code 型号	Qty/box 每小盒数量 (pcs)	List Price 大价 (RM/100pcs)	
		W	F				
<b>Male 公</b>							
	1.5mm <sup>2</sup>		4.0	8.5	<b>F1.25A</b>	2,500	18.00
	2.5mm <sup>2</sup>		4.0	8.5	<b>F2A(4)</b>	2,500	19.00
			5.0	8.5	<b>F2A(5)</b>		23.00
	4 - 6mm <sup>2</sup>		5.0	8.5	<b>F5.5A</b>	2,000	24.00
<b>Female 母</b>							
	1.5mm <sup>2</sup>		3.9	7.3	<b>F1.25B</b>	2,000	24.00
	2.5mm <sup>2</sup>		3.9	7.3	<b>F2B(4)</b>	1,500	25.00
			4.9	7.0	<b>F2B(5)</b>		29.00
	4 - 6mm <sup>2</sup>	4.9	7.0	<b>F5.5B</b>	1,000	35.00	

### 钩型公母插 Piggyback Insulated Disconnectors (Taiwan)

Type 款型	Cable Size 电线规格(mm <sup>2</sup> )	Dimension 尺寸(mm)		Item Code 型号	Qty/box 每小盒数量 (pcs)	List Price 大价 (RM/100pcs)	
		W (W1)	F (F1)				
	1.5mm <sup>2</sup>		6.8 (6.3)	8.0 (8.2)	<b>MF1.25</b>	1,600	37.00
	2.5mm <sup>2</sup>		6.8 (6.3)	8.0 (8.2)	<b>MF2</b>	1,500	38.00
			6.8 (6.3)	8.0 (8.2)	<b>MF5.5</b>		46.00

### 绝缘中间套管 Insulated Link

Type 款型	Cable Size 电线规格(mm <sup>2</sup> )	Dimension 尺寸(mm)		Item Code 型号	Qty/box 每小盒数量 (pcs)	List Price 大价 (RM/100pcs)	
		L	d				
	1.5mm <sup>2</sup>		23.0	2.0	<b>BF1.25</b>	2,000	16.00
	2.5mm <sup>2</sup>		23.2	2.4	<b>BF2</b>	1,800	18.00
	4 - 6mm <sup>2</sup>		25.5	3.6	<b>BF5.5</b>	1,000	32.00



Type 款型	Cable Size 电线规格(mm <sup>2</sup> )	Dimension 尺寸(mm)	Item Code 型号	Qty/box 每小盒数量 (pcs)	List Price 大价 (RM/100pcs)			
		<u>W</u> <u>F</u>						
	1.5mm <sup>2</sup>		2.3    10.0	<b>PIN1.25F10</b>	3,000	19.00		
			2.3    14.5	<b>PIN1.25F14</b>	3,000	19.00		
			2.3    18.0	<b>PIN1.25F18</b>	2,500	19.00		
	2.5mm <sup>2</sup>		2.3    10.0	<b>PIN2F10</b>	2,500	22.00		
			2.3    13.0	<b>PIN2F13</b>	2,500	20.00		
			2.3    18.0	<b>PIN2F18</b>	2,500	20.00		
4-6mm <sup>2</sup>		3.0    10.0	<b>PIN5.5F10</b>	1,500	33.00			
		3.0    18.0	<b>PIN5.5F18</b>	1,500	38.00			
Non-insulated 裸体平板型	1.5mm <sup>2</sup>		2.3    10.0	<b>TPIN1.25F10</b>	5,000	19.00		
			2.3    14.0	<b>TPIN1.25F14</b>	5,000	19.00		
			2.3    18.0	<b>TPIN1.25F18</b>	3,000	19.00		
	2.5mm <sup>2</sup>		2.3    10.0	<b>TPIN2F10</b>	5,000	23.00		
			2.3    13.0	<b>TPIN2F14</b>	4,000	23.00		
			2.3    18.0	<b>TPIN2F18</b>	4,000	20.00		
4-6mm <sup>2</sup>		3.0    18.0	<b>TPIN5.5F18</b>	2,500	36.00			
Round Pin 圆型针	1.5mm <sup>2</sup>		<u>W</u> <u>F</u> 2.0    12.5	<b>PIN1.25</b>	2,500	16.00		
		2.5mm <sup>2</sup>		2.0    12.9	<b>PIN2</b>	2,500	19.00	
				2.7    13.8	<b>PIN5.5</b>	1,500	38.00	
	Non-insulated 裸体圆型	1.5mm <sup>2</sup>		<u>W</u> <u>F</u> 2.0    11.8	<b>TPIN1.25</b>	5,000	15.00	
			2.5mm <sup>2</sup>		2.0    12.2	<b>TPIN2</b>	5,000	20.00
				4-6mm <sup>2</sup>		2.7    13.7	<b>TPIN5.5</b>	3,000
CP 扁形铜管端子			<u>W</u> <u>F</u> 5.0    12.0	<b>CP10</b>	1,800	125.00		
			6.0    15.0	<b>CP16</b>	1,200	185.00		
			7.0    18.0	<b>CP25</b>	800	260.00		
			9.0    18.0	<b>CP35</b>	500	440.00		
			10.0    21.0	<b>CP50</b>	300	580.00		
			4.3    12.0	<b>KS10-12</b>	1,500	90.00		
KS(Taiwan) 裸体平板型			5.5    13.0	<b>KS16-13</b>	1,000	156.00		
			6.8    14.0	<b>KS25-15</b>	500	236.00		
			8.0    21.0	<b>KS35-20</b>	300	400.00		
			9.5    21.0	<b>KS50-20</b>	200	565.00		
			11.0    24.5	<b>KS70-25</b>	150	900.00		
			12.5    26.0	<b>KS95-25</b>	100	1,295.00		
			14.3    33.0	<b>KS120-34</b>	90	1,950.00		
			16.8    32.0	<b>KS150-37</b>	60	2,200.00		
			19.0    32.0	<b>KS185-38</b>	40	3,150.00		
			21.5    38.0	<b>KS240-44</b>	30	4,700.00		





Type 款型	Cable Size 电线规格 (mm <sup>2</sup> )	Dimension 尺寸 (mm)		Item Code 型号	Colour 绝缘颜色	List Price 大价 (RM/100pcs)
		F (铜管长度)	C			
	0.25mm <sup>2</sup>	8.0	0.75	LT02508	Light Blue 浅蓝	10.30
		6.0	1.0	LT05006	Orange 橙	7.80
	0.5mm <sup>2</sup>	8.0	1.0	LT05008		7.40
		10.0	1.0	LT05010		8.00
		6.0	1.2	LT07506		White 白
	0.75mm <sup>2</sup>	8.0	1.2	LT07508	7.50	
		10.0	1.2	LT07510	8.70	
		12.0	1.2	LT07512	8.70	
	1mm <sup>2</sup>	8.0	1.4	LT10008	Red 红	12.30
		6.0	1.4	LT10006	Yellow 黄	7.80
	1mm <sup>2</sup>	8.0	1.4	LT10008		7.40
		10.0	1.4	LT10010		9.00
		12.0	1.4	LT10012		10.50
	1.5mm <sup>2</sup>	8.0	1.7	LT15008	Black 黑	11.40
		8.0	1.7	LT15008	Red 红	7.40
	1.5mm <sup>2</sup>	10.0	1.7	LT15010		8.30
		12.0	1.7	LT15012		8.40
		2.5mm <sup>2</sup>	8.0	2.2	LT25008	Blue 蓝
	10.0		2.2	LT25010	9.50	
	12.0		2.2	LT25012	9.80	
4mm <sup>2</sup>	10.0	2.8	LT40010	Grey 灰	14.50	
	12.0	2.8	LT40012		14.70	
6mm <sup>2</sup>	12.0	3.5	LT60012	Black 黑	15.50	
10mm <sup>2</sup>	12.0	4.5	LT100012	Ivory 象牙色	18.50	
16mm <sup>2</sup>	12.0	5.8	LT160012	Green 绿	27.00	
25mm <sup>2</sup>	16.0	7.3	LT250016	Brown 褐色	47.00	
35mm <sup>2</sup>	16.0	8.3	LT350016	Beige 米色	54.00	
50mm <sup>2</sup>	20.0	10.3	LT500020	Olive 橄榄色	123.00	
70mm <sup>2</sup>	21.0	13.5	LT700021	Yellow 黄	300.00	
95mm <sup>2</sup>	25.0	14.7	LT950025	Red 红	375.00	
120mm <sup>2</sup>	27.0	16.7	LT1200027	Blue 蓝	440.00	

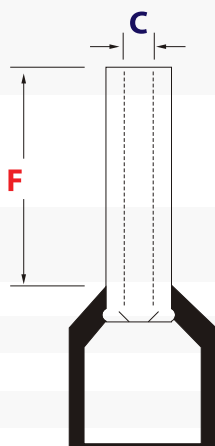

## 双绝缘欧式端子 (台湾) Twin Cord-end Terminal

Type 款型	Cable Size 电线规格 (mm <sup>2</sup> )	Dimension 尺寸 (mm)		Item Code 型号	Colour 绝缘颜色	List Price 大价 (RM/100pcs)
		F (铜管长度)	C			
	0.5mm <sup>2</sup>	8.0	1.5	CT2-05008	Orange 橙	17.80
		0.75mm <sup>2</sup>	8.0	1.8	CT2-07508	White 白
	1mm <sup>2</sup>	8.0	2.05	CT2-10008	Yellow 黄	16.50
		8.0	2.3	CT2-15008	Red 红	16.50
	2.5mm <sup>2</sup>	10.0	2.8	CT2-25010	Blue 蓝	20.00
	4mm <sup>2</sup>	12.0	3.7	CT2-40012	Grey 灰	40.00

Crimping Tool 适用工具 Page 18 页



Type 款型	Dimension 尺寸 C (mm)	Suitable Wire range 电线容量 (估计)		Item Code 型号	Qty/box (pcs)	List Price 大价 (RM/100pcs)	
		Max 最大	Min 最小				
		2.6	(2x0.5 + 1x0.8)mm <sup>2</sup>	2 x 0.5mm <sup>2</sup>	SD1.25	2,500	12.80
		3.0	(1x0.8 + 1x2.0)mm <sup>2</sup>	2 x 0.5mm <sup>2</sup>	SD2	1,800	13.70
		4.0	3 x 2.0mm <sup>2</sup>	(2x0.5 + 2x0.8)mm <sup>2</sup>	SD5.5	800	23.00

Crimping Tool 适用工具 Page 17 页

## 弹簧螺式接头

## Wire-Nut Connectors (Taiwan)

Type 款型	Suitable Wire (flexible) range 电线容量 (估计)		Colour 颜色	Item Code 型号	Qty/box (pcs)	List Price 大价 (RM/100pcs)
	Max 最大	Min 最小				
	2 x 1.25mm <sup>2</sup>	2 x 0.3mm <sup>2</sup>	Grey	SP1	1,400	11.30
	3 x 1.25mm <sup>2</sup>	2 x 0.3mm <sup>2</sup>	Blue	SP2	800	13.00
	(4x1.25 + 1x0.5)mm <sup>2</sup>	(1x0.8 + 1x0.5)mm <sup>2</sup>	Orange	SP3	500	17.00
	(2x3.0 + 2x2.0)mm <sup>2</sup>	3 x 0.5mm <sup>2</sup>	Yellow	SP4	400	24.50
	(2x5.25 + 2x3.30)mm <sup>2</sup>	2 x 2.0mm <sup>2</sup>	Red	SP5	300	38.00

## 塑料套管

## Vinyl End Cap (Taiwan)

Type 款型	Cable Lug Size 端子规格 (mm <sup>2</sup> )	Dimension 尺寸(mm)		Item Code 型号	Qty/bag (pcs)	List Price 大价 (RM/100pcs)	
		D1	D2				
	1.5 mm <sup>2</sup>	3.3	3.1	V1.25	100	6.70	
	2.5 mm <sup>2</sup>	4.5	3.7	V2	100	7.80	
	4 mm <sup>2</sup>	5.7	4.1	V3.5	100	8.70	
	6 mm <sup>2</sup>	5.7	5.2	V5.5	100	9.60	
	10 mm <sup>2</sup>	7.2	6.2	V8	100	13.40	
	16 mm <sup>2</sup>	10.0	8.0	V14	100	18.20	
	25/35 mm <sup>2</sup>	12.0	9.5	V22	100	24.50	
	50 mm <sup>2</sup>	14.0	11.8	V38	100	31.00	
	70 mm <sup>2</sup>	17.0	13.9	V60	100	48.00	
	95 mm <sup>2</sup>	19.0	16.0	V80	50	74.00	
	120 mm <sup>2</sup>	22.0	18.0	V100	50	103.00	
	150 mm <sup>2</sup>	24.0	22.0	V125	50	127.00	
	185 mm <sup>2</sup>	26.0	22.0	V150	50	132.00	
	240 mm <sup>2</sup>	32.2	24.0	V200	50	170.00	
	300 mm <sup>2</sup>	36.5	27.2	V250	50	190.00	
350 mm <sup>2</sup>	36.7	30.0	V325	25	226.00		
400 mm <sup>2</sup>	45.1	37.5	V400	25	390.00		
500 mm <sup>2</sup>	48.2	40.2	V500	25	480.00		
630 mm <sup>2</sup>	53.8	45.2	V630	25	725.00		
	Brown/White/Grey/褐色/白色/灰色	6 mm <sup>2</sup>	5.7	5.2	V5.5	100	14.00
		10 mm <sup>2</sup>	7.2	6.2	V8	100	17.00
		16 mm <sup>2</sup>	10.0	8.0	V14	100	24.00
		25/35 mm <sup>2</sup>	12.0	9.5	V22	100	32.00
		50 mm <sup>2</sup>	14.0	11.8	V38	100	40.00
	70 mm <sup>2</sup>	17.0	13.9	V60	100	61.00	

Note : V5.5 no White / 注明: V5.5 没有白色

Type 款型	Ampere (A) 适用电流	Item Code 型号	Qty/box (pcs)	List Price 大价 (RM/pc)
<b>PVC Connector 透明塑料接线排</b>				
	10A	H10PE	500	1.80
	20A	H20PE	400	3.00
	30A	H30PE	300	4.30
	60A	F60PE	200	10.00
<b>Nylon Connector 高温 - 奶白色</b>				
	10A	H10PA	500	2.60
	20A	H20PA	400	4.10
	30A	H30PA	300	5.30
	For transformer/Autotrans 适用变压器 :			
	10A	HB10PA/ZN	500	3.30

**Piercing Connector 绝缘穿刺线夹**

Applicable Wire range 适用电线	Item Code 型号	Qty/box (pcs)	List Price 大价 (RM/pc)
95-16 mm <sup>2</sup>	IPC3.1	100	7.30
95-50 mm <sup>2</sup>	IPC3.2	100	8.00
185-120 mm <sup>2</sup>	IPC3.3	100	11.50
185-70 mm <sup>2</sup>	IPC3.4	40	24.50
<b>Dead-end Clamp 绝缘耐张线夹</b>			
Applicable Wire range 适用电线 16-25 mm <sup>2</sup>	DC2.1	100	11.00



IPC 3.1



IPC 3.2



IPC 3.3



IPC 3.4



DC 2.1

**电线接头C-型夹(纯铜)****Copper C-Clamp**

Type 款型	Applicable Wire range 适用电线		Item Code 型号	List Price 大价 (RM/pc)
	Wire in 主线截面	Wire out 分支截面		
	25 mm <sup>2</sup> - 16 mm <sup>2</sup>	25 mm <sup>2</sup> - 16 mm <sup>2</sup>	CRC5	5.00
	35 mm <sup>2</sup> - 35 mm <sup>2</sup>	35 mm <sup>2</sup> - 16 mm <sup>2</sup>	CRC7	10.00
	70 mm <sup>2</sup> - 50 mm <sup>2</sup>	70 mm <sup>2</sup> - 35 mm <sup>2</sup>	CRC9	20.00
	95 mm <sup>2</sup> - 70 mm <sup>2</sup>	70 mm <sup>2</sup> - 35 mm <sup>2</sup>	CRC11	34.00
	95 mm <sup>2</sup> - 95 mm <sup>2</sup>	95 mm <sup>2</sup> - 95 mm <sup>2</sup>	CRC12	35.00
	120 mm <sup>2</sup> - 120 mm <sup>2</sup>	120 mm <sup>2</sup> - 25 mm <sup>2</sup>	CRC13	36.00





Page 16 页

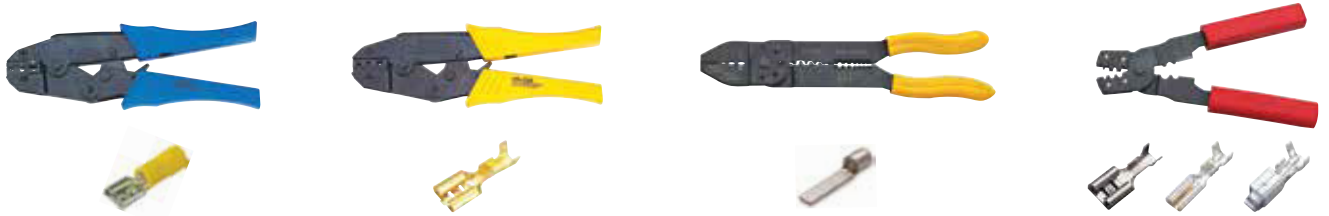

Page 17 页

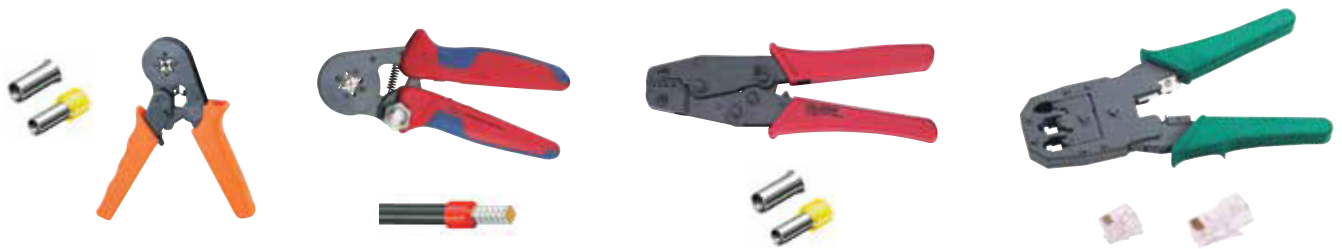

Page 18 页



Page 19 页



Page 20 页





Die set 钳口	Range of Application 应用范围	Item Code 型号	Crimping Range (mm <sup>2</sup> ) (压接范围)	List Price 大价 (RM/pc)
<b>(Point type 压后呈点式)</b>				
		<b>HD6</b>	0.5 - 6.0 mm <sup>2</sup>	<b>52.00</b>
		<b>HS8</b>	1.25 - 10.0 mm <sup>2</sup>	<b>60.00</b>
	<b>(Point type) (压后呈点式)</b>	<b>HS16</b>	1.5 - 16.0 mm <sup>2</sup>	<b>63.00</b>
		<b>HS22</b>	6.0 - 25.0 mm <sup>2</sup>	<b>113.00</b>
		<b>HS38</b>	6.0 - 35.0 mm <sup>2</sup>	<b>115.00</b>
		<b>CT38</b>	10 - 35 mm <sup>2</sup>	<b>195.00</b>
		<b>CT80</b>	10 - 95 mm <sup>2</sup>	<b>278.00</b>
		<b>CT150</b>	16 - 150 mm <sup>2</sup>	<b>360.00</b>
<b>(Hexagonal type 压后呈六角形)</b>				
		<b>HX16</b>	6.0 - 16.0 mm <sup>2</sup>	<b>63.00</b>
		<b>HX26B</b>	6.0 - 25.0 mm <sup>2</sup>	<b>113.00</b>
	<b>(Hexagonal type) (压后呈六角形)</b>	<b>HX50SC</b>	6 - 50 mm <sup>2</sup>	<b>148.00</b>
		<b>HX120SC</b>	10 - 120 mm <sup>2</sup>	<b>265.00</b>
		<b>HX150SC</b>	25 - 150 mm <sup>2</sup>	<b>280.00</b>
<b>Hydraulic Crimping Tool 快速液压钳</b>	<b>(Hexagonal type) (压后呈六角形)</b>	<b>YQK300</b>	10 - 300 mm <sup>2</sup>	<b>290.00</b>





# Crimping Tools (Ratchet-type)

## 棘轮式端子压接钳省力型























Die set 钳口	Range of Application 应用范围	Item Code 型号	Crimping Range 压接范围 (mm <sup>2</sup> )	List Price大价 (RM/pc)
棘轮式压接钳(欧洲型)				
		HS30J	0.5 - 6.0 mm <sup>2</sup>	52.00
		HS101	0.5 - 10.0 mm <sup>2</sup>	52.00
		HS03BC	0.5 - 6.0 mm <sup>2</sup>	52.00
		HS07FL	1.5 - 2.5 mm <sup>2</sup>	60.00
		HS056FL	0.5 - 1.5 mm <sup>2</sup> 0.5 - 2.5 mm <sup>2</sup>	115.00
		HS103	0.5 - 6.0 mm <sup>2</sup>	60.00
	RG59 RG6	HS02H1	1.0 - 6.5 mm <sup>2</sup>	52.00
	太阳能端子 (MC4 卷压) Solar connectors	HS2546B	2.5, 4.0, 6.0 mm <sup>2</sup>	52.00
	车削端子 Turned Contacts	HS-HT4	0.14-1.0, 1.5, 2.5, 4.0 mm <sup>2</sup>	148.00
多功能压接钳 Multi Functional Crimping Pliers				
	5-in-1 Functions : Stripping, Cutting & Crimping 5合1: 剥线, 剪线, 压接裸体端子	HS313		22.00
	非绝缘开放式插塞型接头	HS202B	0.08 - 2.5 mm <sup>2</sup>	22.00

CRIMPING TOOLS 棘轮式端子压接钳省力型

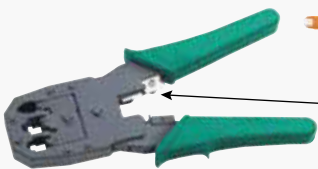



Die set 钳口	Range of Application 应用范围	Item Code 型号	Crimping Range 压接范围 (mm <sup>2</sup> )	List Price大价 (RM/pc)
<b>套管式专用钳 (压后呈正四边形)</b>				
 <p>HSC8 6-4</p>  <p>HSC8 16-4</p>	 <p>绝缘/非绝缘欧式端子</p> 	HSC86-4	0.25 - 6.0 mm <sup>2</sup>	82.00
		HSC816-4	4.0 - 16.0 mm <sup>2</sup>	110.00
 <p>压力调节器 (Adjustable knob)</p>  <p>压力调节器 (Adjustable knob)</p>	 <p>(压后呈正四边形) Square shape crimp</p> 	HSC86-4C	0.25 - 10.0 mm <sup>2</sup>	110.00
		HSC916-4A	0.25 - 16.0 mm <sup>2</sup>	155.00
	 	HS05WF	0.5 - 6.0 mm <sup>2</sup>	65.00
	 	HS35WF	10, 16, 25, 35 mm <sup>2</sup>	70.00
	  <p>(压后呈正六边形) Hexagonal shape crimp</p>	HSC86-6A	0.25 - 6.0 mm <sup>2</sup>	100.00
<b>Telekom Tool (3-in-1) 电讯接头压接钳 (3合1)</b>				
 <p>Cutting, Stripping 剪线, 剥线</p>		HT315	 <p>RJ10 (4芯)</p>	28.00
 <p>Ratchet Type 棘轮式端子 压接钳省力型</p>		HT2008R	 <p>RJ11 (6芯)</p>  <p>RJ45 (8芯)</p>	56.00



### Ratchet Cable Cutter 棘轮式电线剪



8"



10"



12"



14"



20"

VC30A	VC36A	VC60A	VSJ62A	VSJ80A
up to / 限制 240 mm <sup>2</sup>	up to / 限制 300 mm <sup>2</sup>	up to / 限制 500 mm <sup>2</sup>	up to / 限制 800 mm <sup>2</sup>	up to / 限制 1000 mm <sup>2</sup>
N.A.	List Price RM402.00	List Price RM495.00	List Price RM950.00	List Price RM1,300.00

For cutting copper and aluminium single conductors as well as multiple stranded cables  
 Not suitable for steel wire and wire ropes  
 用以剪切铜铝电线，单股线和多股线。不可用于剪切钢丝，钢丝索及钢芯铝绞线

### 剥线工具

### Wire Stripping Tools

Automatic Wire Stripper 自动剥线钳

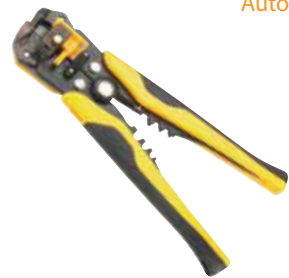

Cutter & Wire Stripper 多功能电线剥皮钳



Fibre Optic Cable Cutter & Wire Stripper 光纤电线剥线钳



HS-D1	HS700B	HS700D	HS1041	FSA0625
List Price RM53.00	List Price RM36.00	List Price RM26.00	List Price RM14.00	List Price RM34.00

<p>Wire Stripping 剥线限制: 0.25 - 6.0 mm<sup>2</sup></p> <p>Wire Cutting 剪切限制: 0.25 - 6.0 mm<sup>2</sup></p> <p>Crimping terminal 压接端子: 0.5 - 6.0 mm<sup>2</sup></p>	<p>Wire Stripping 剥线限制: 0.5 - 6.0 mm<sup>2</sup></p> <p>Ø1.0, 1.6, 2.0, 2.6, 3.2mm</p> <p>Single Wire      Core Wire</p>	<p>剪切, 压接两用</p> <p>Wire Stripping 剥线限制: 0.25 - 6.0 mm<sup>2</sup></p> <p>Wire Cutting 剪切限制: 0.25 - 6.0 mm<sup>2</sup></p>	<p>Wire Stripping 剥线限制: 0.9 - 6.0 mm<sup>2</sup></p> <p>Wire Cutting 剪切限制: ≤16.0 mm<sup>2</sup></p> <p>Crimping terminal 压接端子</p>	<p>Wire Stripping 剥线限制: 0.2 - 2.4 mm<sup>2</sup></p> <p>Wire Cutting 剪切电线限制: ≤25.0 mm<sup>2</sup></p>
---	--	---	---	---

CHISU  
JAPAN

REX™













SHELL™

RONG YUNN  
CROMPLING PLIBRO & CABLE CUTTERS

## 开孔器 / 导管工具

Type 款型	Range of Application 应用范围	Item Code 型号	Cutting Range 剪切范围 (mm <sup>2</sup> )	List Price大价 (RM/pc)
<b>CHISU High Speed Steel Hole Cutter 高速钢镀镍开孔器</b>				
	 Hole Cutting 孔切铁板	HC19	19mm	10.50
		HC20	20mm	11.50
		HC22	22mm	12.50
		HC25	25mm	14.50
		HC32	32mm	18.00
		HC38	38mm	21.00
		HC50	50mm	29.00
		HC-32-REX	32mm	14.00
		HC-38-REX	38mm	17.00

## Pipe Tools 导管工具

	<b>No.1 Pipe Vice</b> 1号管子台虎钳		<b>Item Code</b> 型号 <b>HPV-1</b>	Pipe size from : 导管外径 3/4" to 2"	<b>List Price大价</b> (RM/pc) <b>76.00</b>		
	<b>"SHELL" Conduit Dies Set</b> "SHELL" 管子铰板		<b>JT4411PD</b>	Spare Dies set 板牙套 19, 25, 31, 38 mm	<b>178.00</b>		
	Spare Dies 板牙		<b>SP19</b> <b>SP25</b> <b>SP31</b> <b>SP38</b>	Conduit pipe size : 导管外径 19mm 25mm 31mm 38mm	<b>25.00</b> <b>25.00</b> <b>26.00</b> <b>28.00</b>		
	 <b>Twisted Pair Cable puller</b> 电线管穿线工具 (15m)		<b>TWP-15</b>	Length : 长度 15 mt	<b>40.00</b>		
	<b>PVC Pipe Bending Spring</b> 弯管弹簧		<b>BS20</b> <b>BS25</b>	PVC pipe size : PVC管外径 20mm 25mm	<b>9.50</b> <b>12.50</b>		
	<b>"SHELL" UK Flat type</b> "SHELL" UK 平面 (黑)						
	<b>PVC Pipe Cutter</b> 塑料管剪切钳		<b>For cutting PVC pipes : 合适的切割范围</b> 20 - 32 mm		<b>FYC101C</b>	Tool length : 钳子长度 195mm / 8"	<b>15.50</b>



Page 22 页

Page 23 页



Page 24 页

Page 25 页

Page 25 页



Page 23 页

Page 24 页

Page 28 页



Page 26 页

Page 24 页



Page 27 页

Page 28 页





**3Pin Plug**

2P + E

**IP44**

<b>P013</b>	<b>P023</b>
16A3Pin	32A3Pin
<b>List Price RM7.00</b>	<b>List Price RM12.00</b>

**3Pin Wall Skt**

2P + E

**IP44**

<b>S113</b>	<b>S123</b>
16A3Pin	32A3Pin
<b>List Price RM11.00</b>	<b>List Price RM15.00</b>

**3Pin Coupler**

2P + E

**IP44**

<b>C213</b>	<b>C223</b>
16A3Pin	32A3Pin
<b>List Price RM8.80</b>	<b>List Price RM13.40</b>

**4Pin Plug**

3P + E

**IP44**

<b>P014</b>	<b>P024</b>
16A4Pin	32A4Pin
<b>List Price RM8.60</b>	<b>List Price RM13.50</b>

**4Pin Wall Skt**

3P + E

**IP44**

<b>S114</b>	<b>S124</b>
16A4Pin	32A4Pin
<b>List Price RM12.60</b>	<b>List Price RM15.60</b>

**4Pin Coupler**

3P + E

**IP44**

<b>C214</b>	<b>C224</b>
16A4Pin	32A4Pin
<b>List Price RM9.80</b>	<b>List Price RM14.00</b>

**5Pin Plug**

3P + N + E

**IP44**

<b>P015</b>	<b>P025</b>
16A5Pin	32A5Pin
<b>List Price RM10.80</b>	<b>List Price RM15.60</b>

**5Pin Wall Skt**

3P + N + E

**IP44**

<b>S115</b>	<b>S125</b>
16A5Pin	32A5Pin
<b>List Price RM14.80</b>	<b>List Price RM18.00</b>

**5Pin Coupler**

3P + N + E

**IP44**

<b>C215</b>	<b>C225</b>
16A5Pin	32A5Pin
<b>List Price RM13.00</b>	<b>List Price RM16.00</b>

## CEE 110V (4hr) 插头/插座 CEE Plug & Socket 110V 4-hr

**3Pin Plug - 4hr**

2P + E

**IP44**

<b>P013-4</b>
16A3Pin 4Hr (110V)
<b>List Price RM8.00</b>

**3Pin Wall Skt - 4hr**

2P + E

**IP44**

<b>S113-4</b>
16A3Pin 4Hr (110V)
<b>List Price RM15.00</b>

**3Pin Coupler - 4hr**



















2P + E

**IP44**

<b>C213-4</b>	<b>C223-4</b>
16A (110V)	32A (110V)
<b>List Price RM11.50</b>	<b>List Price RM17.00</b>





 2P + E <b>3Pin Plug</b>		<b>IP67</b>	 2P + E <b>3Pin Wall Sckt</b>		<b>IP67</b>	 2P + E <b>3Pin Coupler</b>		<b>IP67</b>		
	<b>P033</b>	<b>P043</b>		<b>S133</b>	<b>S143</b>		<b>C233</b>	<b>C243</b>		
	63A3Pin	125A3Pin		63A3Pin	125A3Pin		63A3Pin	125A3Pin		
	<b>List Price</b>	<b>N.A.</b>		<b>List Price</b>	<b>RM76.00</b>		<b>List Price</b>	<b>RM69.00</b>	<b>List Price</b>	<b>RM190.00</b>
 3P + E <b>4Pin Plug</b>		<b>IP67</b>	 3P + E <b>4Pin Wall Sckt</b>		<b>IP67</b>	 3P + E <b>4Pin Coupler</b>		<b>IP67</b>		
	<b>P034</b>	<b>P044</b>		<b>S134</b>	<b>S144</b>		<b>C234</b>	<b>C244</b>		
	63A4Pin	125A4Pin		63A4Pin	125A4Pin		63A4Pin	125A4Pin		
	<b>List Price</b>	<b>RM54.00</b>	<b>List Price</b>	<b>RM78.00</b>	<b>List Price</b>	<b>RM235.00</b>	<b>List Price</b>	<b>RM72.00</b>	<b>List Price</b>	<b>RM200.00</b>
 3P + N + E <b>5Pin Plug</b>		<b>IP67</b>	 3P + N + E <b>5Pin Wall Sckt</b>		<b>IP67</b>	 3P + N + E <b>5Pin Coupler</b>		<b>IP67</b>		
	<b>P035</b>	<b>P045</b>		<b>S135</b>	<b>S145</b>		<b>C235</b>	<b>C245</b>		
	63A5Pin	125A5Pin		63A5Pin	125A5Pin		63A5Pin	125A5Pin		
	<b>List Price</b>	<b>RM60.00</b>	<b>List Price</b>	<b>RM85.00</b>	<b>List Price</b>	<b>RM250.00</b>	<b>List Price</b>	<b>RM81.00</b>	<b>List Price</b>	<b>RM235.00</b>

NEM-CEE 防水插头 / 插座

## CEE 多功能插头-插座 CEE Multi-way Plug & Socket

 2P + E <b>IP44 3Pin 2-way</b>		<b>IP44</b>	 2P + E <b>IP44 3Pin 3-way</b>		<b>IP44</b>	 3P + E <b>IP44 4Pin 3-way</b>		<b>IP44</b>		
	<b>PC1012</b>	<b>PC1022</b>		<b>PC1013</b>	<b>PC1023</b>		<b>PC1014</b>	<b>PC1024</b>		
	16A3Pin	32A3Pin		16A3Pin	32A3Pin		16A4Pin	32A4Pin		
	<b>List Price</b>	<b>RM39.00</b>	<b>List Price</b>	<b>RM48.00</b>	<b>List Price</b>	<b>RM109.00</b>	<b>List Price</b>	<b>RM68.00</b>	<b>List Price</b>	<b>RM109.00</b>



### CEE Angle Panel Mounting Socket 暗装斜座

 <b>3Pin Panel Socket</b>	 <b>IP44</b>	<table border="1"> <tr> <td><b>FA313</b></td> <td><b>FA323</b></td> </tr> <tr> <td>16A3Pin</td> <td>32A3Pin</td> </tr> <tr> <td><b>List Price RM10.00</b></td> <td><b>List Price RM14.80</b></td> </tr> </table>	<b>FA313</b>	<b>FA323</b>	16A3Pin	32A3Pin	<b>List Price RM10.00</b>	<b>List Price RM14.80</b>
	<b>FA313</b>	<b>FA323</b>						
	16A3Pin	32A3Pin						
<b>List Price RM10.00</b>	<b>List Price RM14.80</b>							
 <b>IP44</b>	<table border="1"> <tr> <td><b>FA314</b></td> <td><b>FA324</b></td> </tr> <tr> <td>16A4Pin</td> <td>32A4Pin</td> </tr> <tr> <td><b>List Price RM13.00</b></td> <td><b>List Price RM17.00</b></td> </tr> </table>	<b>FA314</b>	<b>FA324</b>	16A4Pin	32A4Pin	<b>List Price RM13.00</b>	<b>List Price RM17.00</b>	
<b>FA314</b>	<b>FA324</b>							
16A4Pin	32A4Pin							
<b>List Price RM13.00</b>	<b>List Price RM17.00</b>							
 <b>IP44</b>	<table border="1"> <tr> <td><b>FA315</b></td> <td><b>FA325</b></td> </tr> <tr> <td>16A5Pin</td> <td>32A5Pin</td> </tr> <tr> <td><b>List Price RM14.00</b></td> <td><b>List Price RM19.00</b></td> </tr> </table>	<b>FA315</b>	<b>FA325</b>	16A5Pin	32A5Pin	<b>List Price RM14.00</b>	<b>List Price RM19.00</b>	
<b>FA315</b>	<b>FA325</b>							
16A5Pin	32A5Pin							
<b>List Price RM14.00</b>	<b>List Price RM19.00</b>							
 <b>IP44</b>	<p><b>110V (4hr)</b></p> <table border="1"> <tr> <td><b>FA313-4</b></td> </tr> <tr> <td>16A3pin 4Hr (110V)</td> </tr> <tr> <td><b>List Price RM18.00</b></td> </tr> </table>	<b>FA313-4</b>	16A3pin 4Hr (110V)	<b>List Price RM18.00</b>				
<b>FA313-4</b>								
16A3pin 4Hr (110V)								
<b>List Price RM18.00</b>								
 <b>IP67</b>	<table border="1"> <tr> <td><b>PC10132</b></td> </tr> <tr> <td>16A3Pin</td> </tr> <tr> <td><b>List Price RM86.00</b></td> </tr> </table>	<b>PC10132</b>	16A3Pin	<b>List Price RM86.00</b>				
<b>PC10132</b>								
16A3Pin								
<b>List Price RM86.00</b>								
 <b>IP67</b>	<table border="1"> <tr> <td><b>PC10242</b></td> </tr> <tr> <td>32A4Pin</td> </tr> <tr> <td><b>List Price RM140.00</b></td> </tr> </table>	<b>PC10242</b>	32A4Pin	<b>List Price RM140.00</b>				
<b>PC10242</b>								
32A4Pin								
<b>List Price RM140.00</b>								
 <b>IP67</b>	<table border="1"> <tr> <td><b>AJ3131</b></td> <td><b>AJ3232</b></td> </tr> <tr> <td>16A3Pin</td> <td>32A3Pin</td> </tr> <tr> <td><b>List Price RM21.00</b></td> <td><b>List Price RM29.00</b></td> </tr> </table>	<b>AJ3131</b>	<b>AJ3232</b>	16A3Pin	32A3Pin	<b>List Price RM21.00</b>	<b>List Price RM29.00</b>	
<b>AJ3131</b>	<b>AJ3232</b>							
16A3Pin	32A3Pin							
<b>List Price RM21.00</b>	<b>List Price RM29.00</b>							
 <b>IP67</b>	<table border="1"> <tr> <td><b>AJ3142</b></td> <td><b>AJ3241</b></td> </tr> <tr> <td>16A4Pin</td> <td>32A4Pin</td> </tr> <tr> <td><b>List Price RM23.00</b></td> <td><b>List Price RM31.00</b></td> </tr> </table>	<b>AJ3142</b>	<b>AJ3241</b>	16A4Pin	32A4Pin	<b>List Price RM23.00</b>	<b>List Price RM31.00</b>	
<b>AJ3142</b>	<b>AJ3241</b>							
16A4Pin	32A4Pin							
<b>List Price RM23.00</b>	<b>List Price RM31.00</b>							
 <b>IP67</b>	<table border="1"> <tr> <td><b>AJ3152</b></td> <td><b>AJ3251</b></td> </tr> <tr> <td>16A5Pin</td> <td>32A5Pin</td> </tr> <tr> <td><b>List Price RM25.00</b></td> <td><b>List Price RM40.00</b></td> </tr> </table>	<b>AJ3152</b>	<b>AJ3251</b>	16A5Pin	32A5Pin	<b>List Price RM25.00</b>	<b>List Price RM40.00</b>	
<b>AJ3152</b>	<b>AJ3251</b>							
16A5Pin	32A5Pin							
<b>List Price RM25.00</b>	<b>List Price RM40.00</b>							
 <b>IP67</b>	<table border="1"> <tr> <td><b>FA333</b></td> <td><b>FA343</b></td> </tr> <tr> <td>63A3Pin</td> <td>125A3Pin</td> </tr> <tr> <td><b>List Price RM77.00</b></td> <td><b>List Price RM235.00</b></td> </tr> </table>	<b>FA333</b>	<b>FA343</b>	63A3Pin	125A3Pin	<b>List Price RM77.00</b>	<b>List Price RM235.00</b>	
<b>FA333</b>	<b>FA343</b>							
63A3Pin	125A3Pin							
<b>List Price RM77.00</b>	<b>List Price RM235.00</b>							
 <b>IP67</b>	<table border="1"> <tr> <td><b>FA334</b></td> <td><b>FA344</b></td> </tr> <tr> <td>63A4Pin</td> <td>125A4Pin</td> </tr> <tr> <td><b>List Price RM85.00</b></td> <td><b>List Price RM245.00</b></td> </tr> </table>	<b>FA334</b>	<b>FA344</b>	63A4Pin	125A4Pin	<b>List Price RM85.00</b>	<b>List Price RM245.00</b>	
<b>FA334</b>	<b>FA344</b>							
63A4Pin	125A4Pin							
<b>List Price RM85.00</b>	<b>List Price RM245.00</b>							
 <b>IP67</b>	<table border="1"> <tr> <td><b>FA335</b></td> <td><b>FA345</b></td> </tr> <tr> <td>63A5Pin</td> <td>125A5Pin</td> </tr> <tr> <td><b>List Price RM93.00</b></td> <td><b>List Price RM260.00</b></td> </tr> </table>	<b>FA335</b>	<b>FA345</b>	63A5Pin	125A5Pin	<b>List Price RM93.00</b>	<b>List Price RM260.00</b>	
<b>FA335</b>	<b>FA345</b>							
63A5Pin	125A5Pin							
<b>List Price RM93.00</b>	<b>List Price RM260.00</b>							



### CEE Panel Mounting Plug 暗装插头

2P + E <b>3Pin Panel Plug</b>		<b>IP44</b>		
	<b>FS613</b>	<b>FS623</b>		
	16A3Pin	32A3Pin		
	<b>List Price</b> RM15.00	<b>List Price</b> RM21.00		
2P + E <b>3Pin Panel Plug</b>		<b>IP67</b>		
	<b>FS633</b>	<b>FS643</b>		
	63A3Pin	125A3Pin		
	<b>List Price</b> RM86.00	<b>List Price</b> RM205.00		
3P + E <b>4Pin Panel Plug</b>		<b>IP44</b>		
	<b>FS614</b>	<b>FS624</b>		
	16A4Pin	32A4Pin		
	<b>List Price</b> RM17.00	<b>List Price</b> RM23.00		
3P + E <b>4Pin Panel Plug</b>		<b>IP67</b>		
	<b>FS634</b>	<b>FS644</b>		
	63A4Pin	125A4Pin		
	<b>List Price</b> RM90.00	<b>List Price</b> RM215.00		
3P + N + E <b>5Pin Panel Plug</b>		<b>IP44</b>		
	<b>FS615</b>	<b>FS625</b>		
	16A5Pin	32A5Pin		
	<b>List Price</b> RM20.50	<b>List Price</b> RM24.50		
3P + N + E <b>5Pin Panel Plug</b>		<b>IP67</b>		
	<b>FS635</b>	<b>FS645</b>		
	63A5Pin	125A5Pin		
	<b>List Price</b> RM95.00	<b>List Price</b> RM230.00		

NEM-CEE 防水暗装 / 明装插头

### CEE Surface Wall Plug 明装插头

2P + E <b>3Pin Surface Plug</b>		<b>IP44</b>		
	<b>WP513</b>	<b>WP523</b>		
	16A3Pin	32A3Pin		
	<b>List Price</b> RM18.00	<b>List Price</b> RM24.00		
2P + E <b>3Pin Surface Plug</b>		<b>IP67</b>		
	<b>WP533</b>	<b>WP543</b>		
	63A3Pin	125A3Pin		
	<b>List Price</b> RM98.00	<b>List Price</b> RM215.00		
3P + E <b>4Pin Surface Plug</b>		<b>IP44</b>		
	<b>WP514</b>	<b>WP524</b>		
	16A4Pin	32A4Pin		
	<b>List Price</b> RM20.00	<b>List Price</b> RM26.00		
3P + E <b>4Pin Surface Plug</b>		<b>IP67</b>		
	<b>WP534</b>	<b>WP544</b>		
	63A4Pin	125A4Pin		
	<b>List Price</b> RM105.00	<b>List Price</b> RM225.00		
3P + N + E <b>5Pin Surface Plug</b>		<b>IP44</b>		
	<b>WP515</b>	<b>WP525</b>		
	16A5Pin	32A5Pin		
	<b>List Price</b> RM22.00	<b>List Price</b> RM28.00		
3P + N + E <b>5Pin Surface Plug</b>		<b>IP67</b>		
	<b>WP535</b>	<b>WP545</b>		
	63A5Pin	125A5Pin		
	<b>List Price</b> RM108.00	<b>List Price</b> RM245.00		

**3Pin Plug**

2P + E



**IP67**

TP0132	TP0232
16A3Pin	32A3Pin
<b>List Price RM12.00</b>	<b>List Price RM19.00</b>

**3Pin Wall Skt**

2P + E



**IP67**

TS1132	TS1232
16A3Pin	32A3Pin
<b>List Price RM20.00</b>	<b>List Price RM28.00</b>

**3Pin Coupler**

2P + E



**IP67**

TC2132	TC2232
16A3Pin	32A3Pin
<b>List Price RM16.00</b>	<b>List Price RM22.00</b>

**4Pin Plug**

3P + E



**IP67**

TP0142	TP0242
16A4Pin	32A4Pin
<b>List Price RM14.50</b>	<b>List Price RM22.00</b>

**4Pin Wall Skt**

3P + E



**IP67**

TS1142	TS1242
16A4Pin	32A4Pin
<b>List Price RM23.50</b>	<b>List Price RM30.00</b>

**4Pin Coupler**

3P + E



**IP67**

TC2142	TC2242
16A4Pin	32A4Pin
<b>List Price RM17.00</b>	<b>List Price RM24.00</b>

**5Pin Plug**

3P + N + E



**IP67**

TP0152	TP0252
16A5Pin	32A5Pin
<b>List Price RM17.00</b>	<b>List Price RM27.00</b>

**5Pin Wall Skt**

3P + N + E



**IP67**

TS1152	TS1252
16A5Pin	32A5Pin
<b>List Price RM26.00</b>	<b>List Price RM33.00</b>

**5Pin Coupler**

3P + N + E



**IP67**

TC2152	TC2252
16A5Pin	32A5Pin
<b>List Price RM20.00</b>	<b>List Price RM27.00</b>

### 冷藏货柜防水插头/插座

### Plug & Socket for Reefer Container (32A 4pin 3-hr)

**4Pin Plug - 3hr**

3P + E



**IP67**

TP0242-3
32A4pin 3Hr
<b>List Price RM33.00</b>

**4Pin Wall Skt - 3hr**

3P + E



**IP67**

TS1242-3
32A4pin 3Hr
<b>List Price RM47.00</b>

**4Pin Coupler - 3hr**



















3P + E



**IP67**

TC2242-3
32A4pin 3Hr
<b>List Price RM37.00</b>



 2P + E  <b>3Pin Plug</b>		<b>IP67</b>	 2P + E  <b>3Pin Wall Skt</b>		<b>IP67</b>	 2P + E  <b>3Pin Coupler</b>		<b>IP67</b>
	AJ0131	AJ0231		AJ1131	AJ1231		AJ2131	AJ2231
	16A3Pin	32A3Pin		16A3Pin	32A3Pin		16A3Pin	32A3Pin
	<b>List Price RM16.00</b>	<b>List Price RM25.00</b>		<b>List Price RM24.00</b>	<b>List Price RM37.00</b>		<b>List Price RM19.00</b>	<b>List Price RM27.00</b>
 3P + E  <b>4Pin Plug</b>		<b>IP67</b>	 3P + E  <b>4Pin Wall Skt</b>		<b>IP67</b>	 3P + E  <b>4Pin Coupler</b>		<b>IP67</b>
	AJ0141	AJ0241		AJ1141	AJ1241		AJ2141	AJ2241
	16A4Pin	32A4Pin		16A4Pin	32A4Pin		16A4Pin	32A4Pin
	<b>List Price RM18.00</b>	<b>List Price RM27.00</b>		<b>List Price RM26.50</b>	<b>List Price RM38.00</b>		<b>List Price RM21.00</b>	<b>List Price RM32.00</b>
 3P + N + E  <b>5Pin Plug</b>		<b>IP67</b>	 3P + N + E  <b>5Pin Wall Skt</b>		<b>IP67</b>	 3P + N + E  <b>5Pin Coupler</b>		<b>IP67</b>
	AJ0151	AJ0251		AJ1151	AJ1251		AJ2151	AJ2251
	16A5Pin	32A5Pin		16A5Pin	32A5Pin		16A5Pin	32A5Pin
	<b>List Price RM21.00</b>	<b>List Price RM32.00</b>		<b>List Price RM30.00</b>	<b>List Price RM42.00</b>		<b>List Price RM26.00</b>	<b>List Price RM36.00</b>

### 冷藏货柜防水插头/插座

### Plug & Socket for Reefer Container (32A 4pin 3-hr)

 3P + E  <b>4Pin Plug - 3hr</b>		<b>IP67</b>	 3P + E  <b>4Pin Wall Skt - 3hr</b>		<b>IP67</b>	 3P + E  <b>4Pin Coupler - 3hr</b>		<b>IP67</b>
	AJ0241-3	AJ1241-3		AJ2241-3				
	32A4pin 3Hr	32A4pin 3Hr		32A4pin 3Hr				
	<b>List Price RM36.00</b>	<b>List Price RM50.00</b>		<b>List Price RM41.00</b>				



**3Pin Plug** 2P + E



**IP67**

<b>AJ0332</b>
63A3Pin
<b>List Price RM75.00</b>

**3Pin Wall Skt** 2P + E



**IP67**

<b>AJ1332</b>
63A3Pin
<b>List Price RM112.00</b>

**3Pin Coupler** 2P + E



**IP67**

<b>AJ2332</b>
63A3Pin
<b>List Price RM108.00</b>

**4Pin Plug** 3P + E



**IP67**

<b>AJ0342</b>	<b>AJ0442</b>
63A4Pin	125A4Pin
<b>List Price RM80.00</b>	<b>List Price RM290.00</b>

**4Pin Wall Skt** 3P + E



**IP67**

<b>AJ1342</b>	<b>AJ1442</b>
63A4Pin	125A4Pin
<b>List Price RM125.00</b>	<b>List Price RM375.00</b>

**4Pin Coupler** 3P + E



**IP67**

<b>AJ2342</b>	<b>AJ2442</b>
63A4Pin	125A4Pin
<b>List Price RM110.00</b>	<b>List Price RM345.00</b>

**5Pin Plug** 3P + N + E



**IP67**

<b>AJ0352</b>	<b>AJ0452</b>
63A5Pin	125A5Pin
<b>List Price RM92.00</b>	<b>List Price RM310.00</b>

**5Pin Wall Skt** 3P + N + E



**IP67**

<b>AJ1352</b>	<b>AJ1452</b>
63A5Pin	125A5Pin
<b>List Price RM135.00</b>	<b>List Price RM380.00</b>

**5Pin Coupler** 3P + N + E



**IP67**

<b>AJ2352</b>	<b>AJ2452</b>
63A5Pin	125A5Pin
<b>List Price RM128.00</b>	<b>List Price RM350.00</b>

**IP67 16A 3Pin 3-way** 2P + E



**MCB & ELCB**      **16A 3 pin IP67**

## Combination Socket Box

### IP67

### 组合插座箱 IP67

<b>Model</b>	<b>A05M-6-IP67-3C</b>
<b>Plug &amp; Socket</b>	16A3pin IP67
<b>MCB &amp; ELCB</b>	3pcs x 16A 1Pole MCB / 1pc x 40A 2P 0.03A ELCB
<b>List Price</b>	<b>RM420.00</b>



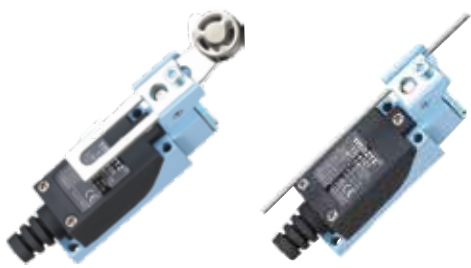

Page 30 页



Page 30 页



T  
M  
A  
Z  
T  
Z  
限  
位  
开  
关  
/  
微  
动  
开  
关



Page 31 页



Page 31 页



Page 32 页

Page 32 页

Page 32 页



Page 33 页



Page 33 页



Page 33 页



Page 33 页

C  
H  
I  
K  
A  
M  
A  
T  
S  
U  
按  
钮  
/  
选  
择  
开  
关  
组  
合

**TMazTZ**®

**CHIKAMATSU**™





<b>TZ8104</b>
List Price RM26.00



<b>TZ8108</b>
List Price RM26.00

M12 Gland

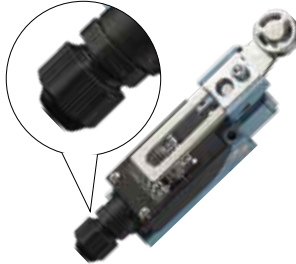

<b>TZ8108-M12</b>
List Price RM26.00



<b>TZ8107</b>
List Price RM24.00



<b>TZ8111</b>
List Price RM21.00



<b>TZ8112</b>
List Price RM21.00



<b>TZ8122</b>
List Price RM21.00



<b>TZ8166</b>
List Price RM21.00



<b>TZ8167</b>
List Price RM21.00



<b>TZ8169</b>
List Price RM21.00

微动开关

**Mini Micro Switches**



<b>V15</b> (MV3000)
List Price RM4.20



<b>V151</b> (MV3002)
List Price RM4.20



<b>V152</b> (MV3003)
List Price RM4.20



<b>V154</b> (MV3001)
List Price RM4.20



<b>V155</b> (MV3004)
List Price RM4.20



<b>V156</b> (MV3005)
List Price RM4.20

小型横式限位开关

**Mini Enclosed Limit Switches**

模块交流接触器

**Modular Contactor 63A**



<b>TZ7310</b>
List Price RM16.00



<b>TZ7311</b>
List Price RM16.00



<b>TZ7121</b>
List Price RM16.00



<b>MC632</b>
List Price RM63.00



<b>MC634</b>
List Price RM85.00

2Pole  
(2 N/O)

4 Pole  
(4 N/O)





**WLD (7101)**

List Price RM52.00



**WLD1 (7102-N)**

List Price RM52.00



**WLD2 (7102)**

List Price RM52.00



**WLD3 (7103)**

List Price RM57.00



**WLCA2-2 (7204)**

List Price RM57.00



**WLCL (7107)**

List Price RM57.00



**WLCA12-2-Q (7208)**

List Price RM57.00



**WLCA32-41 (3241)**

List Price RM65.00



**WLNJ (7106)**

List Price RM52.00

## 微动开关

## Micro Switches



**TM1306**

List Price RM10.00



**TM1307**

List Price RM11.50



**TM1308**

List Price RM12.70



**TM1309**

List Price RM12.70



**CH1300**

List Price RM9.00



**TM1701**

List Price RM10.00



**TM1702**

List Price RM10.00



**TM1703**

List Price RM10.00



**TM1704**

List Price RM10.00



**TAP-Y**

List Price RM2.20



<b>Pushbutton</b> Flat Head 平头按钮				
	<b>AR22A01R</b>	<b>AR22A11R</b>	<b>AR22A10G</b>	<b>AR22A11G</b>
	1N/C	1N/O + 1N/C	1N/O	1N/O + 1N/C
	<b>List Price RM6.20</b>	<b>List Price RM9.40</b>	<b>List Price RM6.20</b>	<b>List Price RM9.40</b>

<b>Other colour caps</b> 其他盖子颜色		1N/O	1N/O + 1N/C
		<b>AR22A10Y</b>	<b>AR22A11Y</b>
		<b>AR22A10S</b>	<b>AR22A11S</b>
		<b>AR22A10B</b>	<b>AR22A11B</b>
		<b>AR22A10W</b>	<b>AR22A11W</b>
		<b>List Price RM6.20</b>	<b>List Price RM9.40</b>

<b>Illuminated LED</b> 带灯按钮				
	<b>AR22TP01R</b>	<b>AR22TP11R</b>	<b>AR22TP10G</b>	<b>AR22TP11G</b>
	1N/C	1N/O + 1N/C	1N/O	1N/O + 1N/C
	<b>List Price RM14.80</b>	<b>List Price RM18.00</b>	<b>List Price RM14.80</b>	<b>List Price RM18.00</b>

<b>Other colour caps</b> 其他盖子颜色		1N/O	1N/O + 1N/C
		<b>AR22TP10Y</b>	<b>AR22TP11Y</b>
		<b>AR22TP10S</b>	<b>AR22TP11S</b>
		<b>List Price RM14.80</b>	<b>List Price RM18.00</b>

\*\*Illuminated LED Pushbutton is available in AC240V & DC24V \*\*带灯LED按钮提供两种电压 AC240V & DC24V

<b>Alternate Illuminated</b> 带灯压锁按钮				
	<b>AR22TPS01R</b>	<b>AR22TPS11R</b>	<b>AR22TPS10G</b>	<b>AR22TPS11G</b>
	1N/C	1N/O + 1N/C	1N/O	1N/O + 1N/C
	<b>List Price RM17.80</b>	<b>List Price RM21.00</b>	<b>List Price RM17.80</b>	<b>List Price RM21.00</b>

<b>Other colour caps</b> 其他盖子颜色		1N/O	1N/O + 1N/C
		<b>AR22TPS10Y</b>	<b>AR22TPS11Y</b>
		<b>AR22TPS10S</b>	<b>AR22TPS11S</b>
		<b>List Price RM17.80</b>	<b>List Price RM21.00</b>

<b>Mushroom Button</b> 40mm 蘑菇头按钮				
	<b>AR22M01R</b>	<b>AR22M11R</b>	<b>AR22M10G</b>	<b>AR22M11G</b>
	1N/C	1N/O + 1N/C	1N/O	1N/O + 1N/C
	<b>List Price RM7.50</b>	<b>List Price RM10.70</b>	<b>List Price RM7.50</b>	<b>List Price RM10.70</b>

<b>Other colour caps</b> 其他盖子颜色		<b>AR22M10Y</b>	<b>AR22M11Y</b>
		1N/O	1N/O + 1N/C
		<b>List Price RM7.50</b>	<b>List Price RM10.70</b>

<b>Emergency Reset</b> 紧急停止按钮		
	<b>AR22ER01</b>	<b>AR22ER11R</b>
	1N/C	1N/O + 1N/C
	<b>List Price RM13.00</b>	<b>List Price RM16.20</b>

Push Reset  
(EMERGENCY STOP)  
紧急停止按钮



<b>22mm Pilot Lamp</b> 面板指示灯		<b>AR229ER</b>	<b>AR229EW</b> 
		<b>AR229EG</b>	
		<b>AR229ES</b>	
		<b>AR229EY</b>	
		<b>List Price RM5.15</b>	<b>List Price RM5.15</b>





<b>On-Off Selector</b> 选择开关			<b>On-Off-On</b>			<b>On-Off Key Selector</b> 选择钥匙开关			<b>On-Off-On</b>					
	AR22N210	AR22N211		AR22N320	AR22K210		AR22K211	AR22K320						
	1N/O	1N/O + 1N/C		2N/O	1N/O		1N/O + 1N/C	2N/O						
	List Price RM9.20	List Price RM12.40	List Price RM12.40	List Price RM15.80	List Price RM19.00	List Price RM19.00								
<b>On-Off Selector</b> 选择开关			<b>On-Off-On</b>			<b>On-Off Key Selector</b> 选择钥匙开关			<b>On-Off-On</b>					
	CCB-N210	CCB-N211		CCB-N320	CCB-K210		CCB-K211	CCB-K320						
	1N/O	1N/O + 1N/C		2N/O	1N/O		1N/O + 1N/C	2N/O						
	List Price RM13.20	List Price RM16.40	List Price RM16.40	List Price RM19.80	List Price RM23.00	List Price RM23.00								
<b>Pushbutton</b> Flat Head 平头按钮					<b>Emergency Reset</b> 紧急停止按钮									
	CCB-A01R	CCB-A11R	CCB-A10G	CCB-A11G		CCB-ER01	CCB-ER11							
	1N/C	1N/O + 1N/C	1N/O	1N/O + 1N/C		1N/C	1N/O + 1N/C							
	List Price RM10.20	List Price RM13.40	List Price RM10.20	List Price RM13.40	List Price RM17.00	List Price RM20.20								
<b>Control Box</b> 防水按钮盒					<b>Contact Block</b> 触头 常开 / 常闭									
	CB-1H	CB-2H	CB-3H	CB-4H		HR10	HR01							
	List Price RM3.80	List Price RM4.60	List Price RM5.80	List Price RM7.80		N/O	N/C							
						List Price RM3.20	List Price RM3.20							
<b>Accessories</b> 按钮配件														
	RT-1	RT-111	HLW29911	APW199	PB22	PB25	ER30							
	Name Plate 12 X 25 mm	Emergency Stop Sticker (紧急停止标贴)	Neon Pushbutton	Neon Pilot Lamp	22mm "STOP"	25mm Pushbutton	30mm Push Reset							
	List Price RM1.10	List Price RM1.30	List Price RM11.50	List Price RM2.70	List Price RM1.20	List Price RM2.50	List Price RM4.00							



灯泡转灯

Page 35 页



LED频闪

Page 35 页



Page 35 页



Page 36 页























Page 36 页





















# NANZHOU 南洲



WARNING DEVICES

警示灯 / 警报器 / 警铃

<b>LTE1101 4"</b> 4" Bulb type 螺栓固定式	  灯泡转灯	AC240 & AC110 & DC12 & DC24 (R/Y/B/G)	List Price RM25.00	<b>LTE5101 4" LED</b> 4" LED FLASH type 螺栓固定式	  LED频闪	AC240 & AC110 & DC12 & DC24 (R/Y/B/G)	List Price RM64.00								
	  灯泡转灯	AC240 & DC12 & DC24 (R/Y/B/G)	List Price RM35.00		  LED频闪	AC240 & DC12 & DC24 (R/Y/B/G)	List Price RM73.00								
<b>LTD1101 4"</b> 4" w/Magnet 磁吸式	  灯泡转灯	DC12 & DC24 (R/Y/B/G)	List Price RM37.00	<b>LTD5101 4" LED</b> 4" w/Magnet 磁吸式	  LED频闪	DC12 & DC24 (R/Y/B/G)	List Price RM78.00								
	  灯泡转灯	AC240 & DC12 & DC24 (R/Y/B/G)	List Price RM67.00		  LED频闪	AC240 (R/Y/B/G) DC24 (RED Only)	List Price RM103.00								
<b>LTD1201</b> Bulb type w/Magnet 磁吸式	  灯泡转灯	DC12 & DC24 (R/Y/B/G)	List Price RM60.00	<b>Accessories</b> 配件	  	<table border="1"> <thead> <tr> <th>Filament</th> <th>Halogen</th> <th>4" Cover</th> </tr> </thead> <tbody> <tr> <td>for 4"</td> <td>for 6"</td> <td>● ● ● ●</td> </tr> <tr> <td>List Price RM3.50</td> <td>List Price RM6.50</td> <td>List Price RM8.00</td> </tr> </tbody> </table>	Filament	Halogen	4" Cover	for 4"	for 6"	● ● ● ●	List Price RM3.50	List Price RM6.50	List Price RM8.00
	Filament	Halogen	4" Cover												
for 4"	for 6"	● ● ● ●													
List Price RM3.50	List Price RM6.50	List Price RM8.00													

<b>MS190</b>		2.5" Baby Mini Siren	<b>MS290</b>		4" Motor Siren (Metal)	<b>MS390</b>		4" Motor Siren
	AC240 & AC110 & DC12 & DC24			AC240 & AC110 & DC12 & DC24			AC240	
	List Price RM32.00			List Price RM55.00			List Price RM130.00	
<b>MS490</b>		4 1/2" Siren AC240	<b>MS590</b>		6" Siren AC240	<b>MS690</b>		8" Siren AC240
	List Price RM381.00			List Price RM750.00			List Price RM1500.00	
<b>MS790</b>		10" Siren AC240	<b>MS790</b>		10" Siren AC240	<b>MS790</b>		10" Siren AC240
	List Price RM1750.00			List Price RM1750.00			List Price RM1750.00	
<b>CB4B</b>		4" Alarm Bell	<b>CB6B</b>		6" Alarm Bell	<b>CB8B-R</b>		8" Alarm Bell
	AC240 & DC12 & DC24			AC240 & DC12 & DC24			AC240 & DC24	
	List Price RM49.00			List Price RM62.00			List Price RM65.00	
<b>CB8B-G</b>		8" Alarm Bell	<b>CB8B-G</b>		8" Alarm Bell	<b>CB8B-G</b>		8" Alarm Bell
	AC240 & DC24			AC240 & DC24			AC240 & DC24	
	List Price RM65.00			List Price RM65.00			List Price RM65.00	
<b>CB10B-R</b>		10" Alarm Bell	<b>CB10B-G</b>		10" Alarm Bell	<b>CB10B-G</b>		10" Alarm Bell
	AC240			AC240			AC240	
	List Price RM78.00			List Price RM78.00			List Price RM78.00	
<b>N80</b>		3" Surface Buzzer	<b>P80</b>		3" Panel Buzzer	<b>P30</b>		1.5" Panel Buzzer
	AC240			AC110 & DC12 & DC24			AC240	
	List Price RM11.50			List Price RM11.50			List Price RM11.50	

# Index 指数



Page 38 页



Page 39 页



Page 41 页



Page 42 页



Page 44 页



Page 44 页



Page 45 页



Page 45 页



Page 46 页



Page 44 页



Page 38 页



Page 39 页



Page 39 页



Page 41 页



Page 42 页



Page 44 页



Page 40 页



Page 44 页



Page 45 页



Page 46 页



Page 46 页



Page 46 页



Page 38 页



Page 40 页



Page 43 页



Page 44 页



Page 46 页



UNI-T VICTOR WINAPEX

优利德 胜利仪器 汉研仪器

UNI-T®

VICTOR®

WINAPEX

i-POOK

BENETECH



 <p>NCV 非接触电压探测</p> <p>1999</p> <p>UNI-T UT33D+</p> <p>QR Code</p>	 <p>~A AC/DC</p> <p>1999</p> <p>Auto Range 自动量程</p> <p>UNI-T UT33A+</p> <p>QR Code</p>	 <p>~A AC/DC</p> <p>1999</p> <p>Auto Range 自动量程</p> <p>UNI-T UT33B+</p> <p>QR Code</p>	 <p>1.5V/9V/12V</p> <p>VoltAlert 防水型测电笔</p> <p>UNI-T UT12D</p> <p>QR Code</p>	 <p>Digital VoltStick 防水型测电笔</p> <p>UNI-T UT15C</p> <p>QR Code</p>
<b>UNI-T. UT33D+</b>	<b>UNI-T. UT33A+</b>	<b>UNI-T. UT33B+</b>	<b>UNI-T. UT12D</b>	<b>UNI-T. UT15C</b>
List Price RM68.00	List Price RM99.00	List Price RM72.00	List Price RM35.00	List Price RM200.00

 <p>TRUE RMS 真有效值</p> <p>NCV 非接触电压探测</p> <p>0.00</p> <p>VICTOR VC202</p> <p>Flashlight</p> <p>QR Code</p>	 <p>TRUE RMS 真有效值</p> <p>NCV 非接触电压探测</p> <p>1888</p> <p>VICTOR VC38D</p> <p>Flashlight</p> <p>QR Code</p>	 <p>TRUE RMS 真有效值</p> <p>NCV 非接触电压探测</p> <p>0.00</p> <p>VICTOR VC203</p> <p>Flashlight</p> <p>QR Code</p>	 <p>TRUE RMS 真有效值</p> <p>NCV 非接触电压探测</p> <p>0.0000</p> <p>°C/F 温度测量</p> <p>VICTOR VC97</p> <p>Flashlight</p> <p>QR Code</p>	 <p>Auto Range 自动量程</p> <p>~A AC/DC</p> <p>TRUE RMS 真有效值</p> <p>NCV 非接触电压探测</p> <p>0.0000</p> <p>VICTOR VC85D</p> <p>Flashlight</p> <p>QR Code</p>
<b>VICTOR® VC202</b>	<b>VICTOR® VC38D</b>	<b>VICTOR® VC203</b>	<b>VICTOR® VC97</b>	<b>VICTOR® VC85D</b>
List Price RM64.00	List Price RM68.00	List Price RM78.00	List Price RM210.00	List Price RM110.00

 <p>~A AC/DC</p> <p>TRUE RMS 真有效值</p> <p>NCV 非接触电压探测</p> <p>0.0000</p> <p>WinAPEX HY108E</p> <p>Flashlight</p> <p>Auto Range 自动量程</p>	 <p>~A AC/DC</p> <p>TRUE RMS 真有效值</p> <p>NCV 非接触电压探测</p> <p>0.0000</p> <p>WinAPEX ET8101</p> <p>Flashlight</p> <p>Auto Range 自动量程</p>	 <p>~A AC/DC</p> <p>TRUE RMS 真有效值</p> <p>NCV 非接触电压探测</p> <p>0.0000</p> <p>WinAPEX ET8102</p> <p>Flashlight</p> <p>Auto Range 自动量程</p>	 <p>VICTOR VC10S</p> <p>QR Code</p>	 <p>VICTOR VC11S</p> <p>QR Code</p>
<b>WinAPEX HY108E</b>	<b>WinAPEX ET8101</b>	<b>WinAPEX ET8102</b>	<b>VICTOR® VC10S</b>	<b>VICTOR® VC11S</b>
List Price RM108.00	List Price RM82.00	List Price RM100.00	List Price RM30.00	List Price RM35.00

NOTE : Please scan the QR code for more detailed specifications  
 注意：详细规格请扫描二维码



UNI-T VICTOR WinAPEX

优利德 胜利仪器 汉研仪器

**Capacitance & Inductance Meter**  
电感电容表

<ul style="list-style-type: none"> <li>电容 (F)</li> <li>电阻</li> <li>hFE</li> </ul>	<ul style="list-style-type: none"> <li>电感</li> <li>电容 (F)</li> <li>电阻</li> <li>hFE</li> </ul>	<ul style="list-style-type: none"> <li>电容 (F)</li> </ul>	<ul style="list-style-type: none"> <li>电感</li> <li>电容 (F)</li> </ul>
<b>UNI-T® UT601</b>	<b>UNI-T® UT603</b>	<b>VICTOR® VC6013</b>	<b>VICTOR® VC6243</b>
List Price RM195.00	List Price RM285.00	List Price RM215.00	List Price RM290.00

<ul style="list-style-type: none"> <li>AC/DC</li> <li>TRUE RMS 真有效值</li> <li>NCV 非接触电压探测</li> <li>电容 (F)</li> <li>Hz</li> <li>hFE</li> <li>Auto Range 自动量程</li> </ul>	<ul style="list-style-type: none"> <li>AC/DC</li> <li>TRUE RMS 真有效值</li> <li>NCV 非接触电压探测</li> <li>电容 (F)</li> <li>Hz</li> <li>°C/F 温度测量</li> <li>Auto Range 自动量程</li> </ul>	<ul style="list-style-type: none"> <li>AC/DC</li> <li>TRUE RMS 真有效值</li> <li>NCV 非接触电压探测</li> <li>电容 (F)</li> <li>°C/F 温度测量</li> <li>Flashlight</li> </ul>	<ul style="list-style-type: none"> <li>AC/DC</li> <li>TRUE RMS 真有效值</li> <li>电容 (F)</li> <li>hFE</li> </ul>
<b>UNI-T® UT61E+</b>	<b>VICTOR® VC86E</b>	<b>VICTOR® VC890C+</b>	<b>VICTOR® VC9806+</b>
List Price RM610.00	List Price RM422.00	List Price RM145.00	List Price RM308.00

**Pen type Digital Multimeter**  
笔型数字仪表

**Analogue Multimeter**  
指针万用表

<ul style="list-style-type: none"> <li>AC/DC</li> <li>TRUE RMS 真有效值</li> <li>NCV 非接触电压探测</li> <li>电容 (F)</li> <li>LIVE 零火线测量</li> <li>Flashlight</li> </ul>			
<b>VICTOR® VC6012A</b>	<b>VICTOR® VC3021</b>	<b>VICTOR® VC7001</b>	<b>samwa YX360TRN</b>
List Price RM139.00	List Price RM93.00	List Price RM55.00	List Price RM42.00

NOTE : Please scan the QR code for more detailed specifications  
注意：详细规格请扫描二维码





<b>VICTOR® VC921</b>	<b>Ruoshui 921</b>	<b>VICTOR® VC922</b>	<b>VICTOR® VC923E</b>
List Price RM74.00	List Price RM66.00	List Price RM89.00	List Price RM185.00



<b>VICTOR® VC923A</b>	<b>VICTOR® VC923C (COLOUR 彩屏)</b>	<b>WinAPEX ET8908</b>	<b>WinAPEX ET8909 Voice Broadcast</b>
List Price RM128.00	List Price RM162.00	List Price RM99.00	List Price RM116.00











<b>WinAPEX ET8136</b>	<b>WinAPEX ET8138 (COLOUR 彩屏)</b>	<b>WinAPEX ET8198DE Voice Control/Broadcast</b>
List Price RM115.00	List Price RM145.00	List Price RM225.00

NOTE : Please scan the QR code for more detailed specifications  
 注意：详细规格请扫描二维码





Insulation Resistance Testers 绝缘电阻测试仪 - (1000V)			
	<b>UNI-T® UT501A</b> (1000V) 	<b>UNI-T® UT501C</b> (1000V) 	<b>VICTOR® VC60B+</b> (1000V) 
	List Price RM370.00	List Price RM335.00	List Price RM320.00
Insulation Resistance Testers 绝缘电阻测试仪 - (2500V)			
	<b>UNI-T® UT502A</b> (2500V) 	<b>UNI-T® UT502C</b> (2500V) 	<b>VICTOR® VC60D+</b> (2500V) 
	List Price RM680.00	List Price RM480.00	List Price RM595.00
Digital RCD (ELCB) Testers 漏电开关测试仪		Power Meter Socket 多功能计量插座电测量测  Amp, Power Factor, Hz, Watt, kWh, CO2 <b>DEBUY PMS2210Y</b>	Insulation Resistance Testers 绝缘电阻测试仪 - (5000V) 
	<b>UNI-T® UT582+</b> 		
List Price RM725.00	List Price RM78.00	List Price RM880.00	
Digital Earth Testers 接地电阻测试仪			 $\mu\Omega$ 电阻
	<b>VICTOR® VC4105A</b> 	<b>UNI-T® UT521</b> 	
	List Price RM625.00	List Price RM885.00	

NOTE : Please scan the QR code for more detailed specifications  
注意：详细规格请扫描二维码



# UNI-T®

# VICTOR®

# WinAPEX®

# 数字钳形 仪表

 <ul style="list-style-type: none"> <li>TRUE RMS 真有效值</li> <li>NCV 非接触电压探测</li> <li>电容 (F)</li> <li>LIVE 零火线测量</li> </ul> 	 <ul style="list-style-type: none"> <li>TRUE RMS 真有效值</li> <li>NCV 非接触电压探测</li> <li>电容 (F)</li> <li>°C/F 温度测量</li> <li>Hz</li> </ul> 	 <ul style="list-style-type: none"> <li>~ A AC/DC</li> <li>TRUE RMS 真有效值</li> <li>NCV 非接触电压探测</li> <li>电容 (F)</li> <li>Hz</li> </ul> 	 <ul style="list-style-type: none"> <li>~ A AC/DC</li> <li>TRUE RMS 真有效值</li> <li>NCV 非接触电压探测</li> <li>电容 (F)</li> <li>°C/F 温度测量</li> <li>LIVE 零火线测量</li> </ul> 	 <ul style="list-style-type: none"> <li>~ A AC/DC</li> <li>Hz</li> <li>°C/F 温度测量</li> <li>电容 (F)</li> </ul> 
<b>UNI-T® UT202A+</b>	<b>UNI-T® UT202+</b>	<b>UNI-T® UT203+</b>	<b>UNI-T® UT204+</b>	<b>UNI-T® UT204A</b>
List Price RM135.00	List Price RM155.00	List Price RM278.00	List Price RM320.00	List Price RM260.00

 <ul style="list-style-type: none"> <li>TRUE RMS 真有效值</li> <li>NCV 非接触电压探测</li> <li>电容 (F)</li> </ul> 	 <ul style="list-style-type: none"> <li>TRUE RMS 真有效值</li> <li>NCV 非接触电压探测</li> <li>电容 (F)</li> <li>°C/F 温度测量</li> </ul> 	 <ul style="list-style-type: none"> <li>~ A AC/DC</li> <li>TRUE RMS 真有效值</li> <li>NCV 非接触电压探测</li> <li>电容 (F)</li> </ul> 	 <ul style="list-style-type: none"> <li>~ A AC/DC</li> <li>TRUE RMS 真有效值</li> <li>NCV 非接触电压探测</li> <li>电容 (F)</li> <li>°C/F 温度测量</li> <li>Flashlight</li> </ul> 	 <ul style="list-style-type: none"> <li>TRUE RMS 真有效值</li> <li>NCV 非接触电压探测</li> <li>电容 (F)</li> <li>°C/F 温度测量</li> <li>Flashlight</li> </ul> 
<b>VICTOR® VC606A</b>	<b>VICTOR® VC606B</b>	<b>VICTOR® VC606C</b>	<b>VICTOR® VC606E</b>	<b>VICTOR® VC606D</b>
List Price RM115.00	List Price RM128.00	List Price RM225.00	List Price RM228.00	List Price RM140.00

 <ul style="list-style-type: none"> <li>TRUE RMS 真有效值</li> <li>NCV 非接触电压探测</li> <li>电容 (F)</li> <li>LowZ 低阻抗</li> <li>Flashlight</li> </ul> 	 <ul style="list-style-type: none"> <li>TRUE RMS 真有效值</li> <li>NCV 非接触电压探测</li> <li>电容 (F)</li> <li>°C/F 温度测量</li> <li>LowZ 低阻抗</li> <li>Flashlight</li> </ul> 	 <ul style="list-style-type: none"> <li>~ A AC/DC</li> <li>TRUE RMS 真有效值</li> <li>NCV 非接触电压探测</li> <li>电容 (F)</li> <li>°C/F 温度测量</li> <li>LowZ 低阻抗</li> </ul> 	 <ul style="list-style-type: none"> <li>~ V 1000V AC/DC</li> <li>TRUE RMS 真有效值</li> <li>NCV 非接触电压探测</li> <li>电容 (F)</li> <li>°C/F 温度测量</li> <li>方波输出</li> <li>Flashlight</li> </ul> 	 <ul style="list-style-type: none"> <li>~ V 1000V</li> <li>TRUE RMS 真有效值</li> <li>NCV 非接触电压探测</li> <li>电容 (F)</li> <li>°C/F 温度测量</li> <li>方波输出</li> <li>Flashlight</li> </ul> 
<b>VICTOR® VC606A+</b>	<b>VICTOR® VC606B+</b>	<b>VICTOR® VC606C+</b>	<b>WinAPEX® ET8203</b>	<b>WinAPEX® ET8202</b>
List Price RM125.00	List Price RM138.00	List Price RM235.00	List Price RM172.00	List Price RM118.00

NOTE : Please scan the QR code for more detailed specifications  
 注意：详细规格请扫描二维码



UNI-T VICTOR WinAPEX

优利德 胜利仪器 汉研仪器

<p>TRUE RMS 真有效值</p> <p>1000V</p> <p>°C/F 温度测量</p> <p>NCV 非接触电压探测</p> <p>电容 (F)</p> <p>Flashlight</p> <p>Auto Range 自动量程</p>	<p>TRUE RMS 真有效值</p> <p>NCV 非接触电压探测</p> <p>电容 (F)</p> <p>Flashlight</p> <p>Auto Range 自动量程</p>	<p>1000V</p> <p>°C/F 温度测量</p> <p>AC/DC</p> <p>TRUE RMS 真有效值</p> <p>NCV 非接触电压探测</p> <p>电容 (F)</p> <p>LIVE 零火线测量</p> <p>Flashlight</p> <p>Auto Range 自动量程</p>	<p>1000V</p> <p>°C/F 温度测量</p> <p>TRUE RMS 真有效值</p> <p>NCV 非接触电压探测</p> <p>电容 (F)</p> <p>Flashlight</p> <p>Auto Range 自动量程</p>	<p>1000V</p> <p>°C/F 温度测量</p> <p>TRUE RMS 真有效值</p> <p>NCV 非接触电压探测</p> <p>电容 (F)</p> <p>Flashlight</p> <p>Auto Range 自动量程</p>
--	--	---	--	--

<b>VICTOR® VC6016B+</b>	<b>WinAPEX ET8201</b>	<b>WinAPEX ET8204</b>	<b>VICTOR® VC608</b>	<b>VICTOR® VC606G</b>
List Price RM105.00	List Price RM135.00	List Price RM195.00	List Price RM163.00	List Price RM130.00

AC/DC 1000A 钳形表	<p>AC/DC 1000A</p> <p>°C/F 温度测量</p> <p>电容 (F)</p> <p>Hz</p>	<p>AC/DC 1000A</p> <p>TRUE RMS 真有效值</p> <p>NCV 非接触电压探测</p> <p>电容 (F)</p> <p>°C/F 温度测量</p> <p>Hz</p>	<p>AC/DC 1000A</p> <p>TRUE RMS 真有效值</p> <p>NCV 非接触电压探测</p> <p>电容 (F)</p> <p>Hz</p>	<p>AC/DC 1000A</p> <p>TRUE RMS 真有效值</p> <p>NCV 非接触电压探测</p> <p>电容 (F)</p> <p>Hz</p> <p>°C/F 温度测量</p> <p>Auto Range 自动量程</p>
-----------------	---	---	--	--

<b>UNI-T. UT208A</b>	<b>UNI-T. UT208B</b>	<b>UNI-T. UT207B</b>	<b>VICTOR® VC3288</b>
List Price RM600.00	List Price RM665.00	List Price RM530.00	List Price RM254.00

**Earth Clamp Testers / Leakage Current**  
钳形接地电阻 / 泄漏电流 测试仪

电阻

UNI-T. UT275+

List Price RM2,700.00

**Flexible Clamp Sensor (3000A)**  
柔性线圈大电流钳表

UNI-T. CS09D

List Price RM450.00

**Flexible Coil Large Current Leakage Clamp Meter**  
柔性线圈大电流漏电钳表

VICTOR® VC690

List Price RM555.00

NOTE : Please scan the QR code for more detailed specifications  
注意 : 详细规格请扫描二维码



UNI-T VICTOR WINAPEX

优利德 胜利仪器 汉研仪器

Pocket type 口袋钳形表



AC/DC  
TRUE RMS  
非接触电压探测  
电容 (F)  
Hz  
°C/F  
温度测量



AC/DC  
TRUE RMS  
非接触电压探测  
电容 (F)  
NCV  
非接触电压探测



TRUE RMS  
非接触电压探测  
°C/F  
温度测量

Auto Range  
自动量程



DC  
TRUE RMS  
非接触电压探测  
°C/F  
温度测量  
NCV  
非接触电压探测

Auto Range  
自动量程

LIVE  
零火线测量



UNI-T UT210D

List Price RM330.00

UNI-T UT210E

List Price RM320.00

VICTOR VC6019A

List Price RM136.00

VICTOR VC6019C

List Price RM308.00



For Body Temperature  
人体测温仪



UNI-T UT300A+

-20 to 400 °C

List Price RM90.00

VICTOR VC303B

-20 to 550 °C

List Price RM105.00

VC304A

-50 to 480 °C

List Price RM88.00

VC304B

-50 to 680 °C

List Price RM118.00

VC304C

-50 to 880 °C

List Price RM149.00

NITIKA HT880D

32 to 42.5 °C

List Price RM65.00



WinAPEX ET6531C

-50 to 600 °C

List Price RM118.00

WinAPEX ET6532

-50 to 600 °C

List Price RM84.00

1000 °C & Above  
1000 °C 以上红外线测温仪



VICTOR VC308D

-50 to 1150 °C

List Price RM750.00

BENETECH

GM1150

-30 to 1150 °C

List Price RM405.00

UNI-T®  
TEST PROBE

HC50

List Price RM10.00



NOTE : Please scan the QR code for more detailed specifications

注意：详细规格请扫描二维码



UNI-T VICTOR WINAPEX

优利德 胜利仪器 汉研仪器

Laser Distance Meter 激光测距仪	40M 40米	50M 50米	70M 70米	100M 100米	40m 米
					
	<b>UNI-T. LM40</b>	<b>UNI-T. LM50A</b>	<b>UNI-T. LM70A</b>	<b>UNI-T. LM100A</b>	<b>VICTOR<sup>®</sup> VC841A</b>
	List Price RM150.00	List Price RM155.00	List Price RM210.00	List Price RM270.00	List Price RM145.00

Laser Distance Meter 激光测距仪	Temperature/Humidity 迷你温湿度计	Tachometer 数字转速表
-------------------------------	-----------------------------	------------------

60m 米			Contact-type 接触式	Contact & Non-Contact-type 两用：接触 & 非接触
				
<b>VICTOR<sup>®</sup> VC841B</b>	<b>UNI-T. UT333</b>	<b>UNI-T. UT320A</b>	<b>VICTOR<sup>®</sup> VC6235P</b>	<b>VICTOR<sup>®</sup> VC6236P</b>
List Price RM200.00	List Price RM115.00	List Price RM110.00	List Price RM155.00	List Price RM225.00

Tachometer (Laser) 非接触式转速计(激光)			Illuminometer (Lux meter) 照度计			
	<b>UNI-T. UT371</b>	<b>UNI-T. UT373</b>		<b>UNI-T. UT381</b>	<b>UNI-T. UT383</b>	<b>VICTOR<sup>®</sup> VC1010C</b>
	List Price RM435.00	List Price RM123.00		List Price RM320.00	List Price RM110.00	List Price RM110.00

NOTE : Please scan the QR code for more detailed specifications  
注意：详细规格请扫描二维码



Wire Tracking Meters 电缆探测仪

Wall Scanner  
墙体探测仪



VC7501



VC518

Underground Cable tracker  
地下电缆故障, 管线,  
电缆走向检测仪



Data cable Tracker  
数字无噪音寻线仪



Network Tester  
网络测试仪  
RJ45/Cat5/6



VICTOR® VC518

List Price RM362.00

VICTOR® VC7501

List Price RM1,175.00

BENETECH® GM60

List Price RM130.00

VICTOR® VC468

List Price RM24.00

Wall Scanner  
墙体探测仪



Anemometer  
数字式风速仪



Anemometer  
数字式风速仪



Anemometer  
数字式风速仪



UNI-T® UT387C

List Price RM255.00

VICTOR® VC816B

List Price RM345.00

VICTOR® VC816

List Price RM113.00

UNI-T® UT363

List Price RM110.00

Coating Thickness  
Gauge  
漆膜仪涂层测厚仪



Vibration Meter  
测振仪



Hygrometer  
木材水份测试仪



Sound Level Meter  
迷你噪音计



3 Phase Indicator  
三相交流电相序计



VICTOR® VC852B

List Price RM690.00

VICTOR® VC63D

List Price RM2,050.00

VICTOR® VC2GA

List Price RM145.00

BENETECH® GM1351

List Price RM103.00

VICTOR® VC850A

List Price RM98.00

NOTE : Please scan the QR code for more detailed specifications  
注意：详细规格请扫描二维码





Page 48 页



Page 48 页



Page 48 页



Page 49 页



Page 49 页



Page 50 页



Page 50 页



Page 50 页



Using  
**MK**  
Switches



Using  
**MK**  
Switches



Page 51 页





2P + E



2P + E



3P + E



3P + E



3P + N + E



3P + N + E

<b>16A3Pin</b>	<b>32A3Pin</b>	<b>16A4Pin</b>	<b>32A4Pin</b>	<b>16A5Pin</b>	<b>32A5Pin</b>
<b>67CEE316</b>	<b>67CEE332</b>	<b>67CEE416</b>	<b>67CEE432</b>	<b>67CEE516</b>	<b>67CEE532</b>
<b>List Price RM92.00</b>	<b>List Price RM108.00</b>	<b>List Price RM98.00</b>	<b>List Price RM118.00</b>	<b>List Price RM108.00</b>	<b>List Price RM130.00</b>



2P + E



3P + E



3P + E



3P + N + E

<b>16A3Pin</b>
<b>R67CEE316</b>
<b>List Price RM145.00</b>

<b>16A4Pin</b>
<b>R67CEE416</b>
<b>List Price RM160.00</b>

<b>63A4Pin</b>
<b>R67CEE463</b>
<b>List Price RM368.00</b>

<b>63A5Pin</b>
<b>R67CEE563</b>
<b>List Price RM405.00</b>



3P + E



3P + N + E

<b>32A4Pin</b>
<b>R67CEE432</b>
<b>List Price RM280.00</b>

<b>32A5Pin</b>
<b>R67CEE532</b>
<b>List Price RM285.00</b>

**冷藏货柜防水插座开关**  
**Switch Socket for Reefer Container**

**32A4Pin - 3hr**

**R67CEE432-3**

**List Price RM285.00**

Please refer to pages 26,27,28 for Plugs  
插头在26,27,28页





# 56 Series Industrial Sockets IP56

## 56系列防水插头/插座 IP56



<b>15A 3Pin</b>
<b>56CV315RP</b>
<b>List Price RM95.00</b>



<b>16A 4Pin</b>	
<b>56CV416</b>	<b>56PA416</b>
<b>List Price RM125.00</b>	<b>List Price RM63.00</b>



<b>16A 5Pin</b>	
<b>56CV516</b>	<b>56PA516</b>
<b>List Price RM154.00</b>	<b>List Price RM73.00</b>



<b>20A 3Pin</b>	
<b>56CV320</b>	<b>56PA320</b>
<b>List Price RM127.00</b>	<b>List Price RM71.00</b>



<b>20A 4Pin</b>	
<b>56CV420</b>	<b>56PA420</b>
<b>List Price RM136.00</b>	<b>List Price RM73.00</b>



<b>20A 5Pin</b>	
<b>56CV520</b>	<b>56PA520</b>
<b>List Price RM163.00</b>	<b>List Price RM82.00</b>



<b>32A 3Pin</b>	
<b>56CV332</b>	<b>56PA332</b>
<b>List Price RM149.00</b>	<b>List Price RM82.00</b>



<b>32A 4Pin</b>	
<b>56CV432</b>	<b>56PA432</b>
<b>List Price RM168.00</b>	<b>List Price RM94.00</b>



<b>32A 5Pin</b>	
<b>56CV532</b>	<b>56PA532</b>
<b>List Price RM180.00</b>	<b>List Price RM103.00</b>

56 SERIES  
56系列防水插头/插座

IP56





### 56SO Series Socket 56SO 系列 防水插座



	3Pin	4Pin	5Pin
<b>16A</b>	N.A.	56SO416	56SO516
		List Price RM69.00	List Price RM73.00
<b>20A</b>	56SO320	56SO420	56SO520
	List Price RM67.00	List Price RM76.00	List Price RM76.00
<b>32A</b>	56SO332	56SO432	56SO532
	List Price RM76.00	List Price RM78.00	List Price RM82.00

32A 3Pole



**pdb** 56SW332

List Price RM89.00

20A DP w/Neon



**pdb** WPS220

List Price RM38.00

2-way Switch

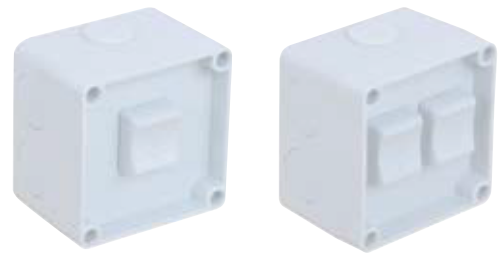

**NEM** WSC226/1

List Price RM27.00

**NEM** WSC226/2

List Price RM34.00

13A 平面盖



**NEM** 56SO313

List Price RM50.00

13A 凹凸盖



**NEM** 56CSC313T

List Price RM50.00

3 Pole Isolator



**NEM**

WHT20 (20A)

List Price RM40.00

WHT35 (35A)

List Price RM40.00

WHT63 (63A)

List Price RM53.00



凹凸盖

**NEM** 56UKC-DG

List Price RM82.00



凹凸盖

**NEM** 56CV313T

List Price RM62.00



平面盖

**NEM** 56CV313

List Price RM62.00



平面盖

**NEM** 56P313

List Price RM25.00

















凹凸盖

**NEM** 56CSC313N

List Price RM52.00



				
<b>66757</b>	<b>66893</b>	<b>66657</b>	<b>66977M (Metalclad)</b>	
List Price RM44.00	List Price RM60.00	List Price RM55.00	List Price RM65.00	
		<b>20A DP w/Neon</b>		
<b>66747</b>	<b>66946M (Metalclad)</b>			
List Price RM78.00	List Price RM105.00			
		<b>66423</b>		
		<b>List Price RM66.00</b>		
				
<b>66870 / 66871 (2-way)</b>	<b>66872</b>	<b>66873</b>	<b>66874</b>	<b>66878B</b>
LP RM43.00/44.00	List Price RM48.00	List Price RM54.00	List Price RM63.00	List Price RM50.00
<b>Universal Socket c/w Neon</b>				<b>32A DP w/Neon</b>
	<b>66827/1</b>	<b>66827/2</b>		
	List Price RM36.00	List Price RM55.00		
				
				<b>66320</b>
				List Price RM40.00

WEATHERSHIELD IP66 IP66 防水插座/开关





Page 53 页



Page 53 页



Page 53 页



Page 54 页



Page 54 页



USB / SOCKETS / TIMERS

开关插座 / 转换开关 / 浮球 / 定时器

开关插座  
转换开关/浮球



<b>Universal Socket c/w USB</b>					
		Black黑	Silver Grey 灰银		
	<b>NLG</b> C1012	<b>NLG</b> C1012 - B	<b>NLG</b> C1012 - S	<b>NLG</b> C2022	
	List Price RM25.00	List Price RM36.00	List Price RM36.00	List Price RM38.00	
<b>Universal Socket 13A</b>					
	<b>NLG</b> C1007	<b>NLG</b> C2007	<b>NEM</b> 827L	<b>NEM</b> 8272L	
	List Price RM10.50	List Price RM20.00	List Price RM10.00	List Price RM19.00	
<b>32A DP c/w Neon</b>		<b>Weatherproof Skt Cover</b>		<b>Doorbell (AC240v)</b>	
	<b>NEM</b> PD32				
List Price RM11.50	<b>NOVEX</b> NWPB-33	List Price RM9.50	<b>TECNO</b> Q302	List Price RM40.00	
<b>Change-over 1-0-2</b>		<b>OTTO</b>	<b>JOSE PIERO</b>	<b>Float Switch</b>	
	C63 4 pole Changeover (1-0-2) c/w PVC Enclosure Box				
	<b>JP040039PEB</b>	<b>JP032039ME</b>			
	List Price RM136.00	LP RM90.00			
		<b>MAC3-2</b>	<b>MAC3-5</b>	<b>MAC3-7</b>	<b>MAC3-10</b>
		2 meter	5 meter	7 meter	10 meter
		LP RM23.00	LP RM37.00	LP RM46.00	LP RM57.00

USB SWITCH SOCKETS / 1-0-2 / FLOAT SWITCH 开关插座 / 转换开关 / 浮球



Type 款型	Description 产品描述	Item Code 型号	List Price 大价 (RM/pc)
	<p><b>TECNO</b></p> <p>24hrs Spring reserve timer</p> <p>Time Interval : 15 mins 间隔时间</p>	<b>TEC241</b>	<b>57.00</b>
	<p><b>TECNO</b></p> <p>24hrs Spring reserve timer</p> <p>Time Interval : 10 mins 间隔时间</p>	<b>TEC711</b>	<b>90.00</b>
	<p><b>NEM</b></p> <p>3 module 24hrs Timer (Din-rail type)</p> <p>Time Interval : 30 mins 间隔时间</p>	<b>TS18</b>	<b>82.00</b>
	<p><b>TECNO SWITCH</b></p> <p>2 module 24hrs Timer (Din-rail type)</p> <p>Time Interval : 30 mins 间隔时间</p>	<b>OR102</b>	<b>75.00</b>
	<p><b>TECNO SWITCH</b></p> <p>1 module 24hrs Timer (Din-rail type)</p> <p>Time Interval : 30 mins 间隔时间</p>	<b>OR101</b>	<b>60.00</b>
	<p><b>Crompton</b></p> <p>1 module 24hrs Digital Timer (Din-rail type)</p> <p>7 Days / 6 Preset Programs</p>	<b>CCD24</b>	<b>55.00</b>
	<p><b>NEM</b></p> <p>Digital 13A Plug-in Timer (24hrs 7 days programmable)</p> <p>20 Preset Programs</p>	<b>MDT269</b>	<b>44.00</b>
	<p><b>NEM</b></p> <p>13A Plug-in Timer (Analogue)</p> <p>Time Interval : 15 mins 间隔时间</p>	<b>TE104</b>	<b>29.00</b>

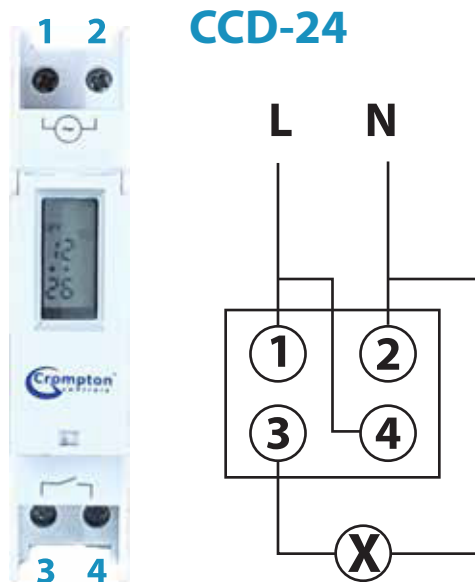
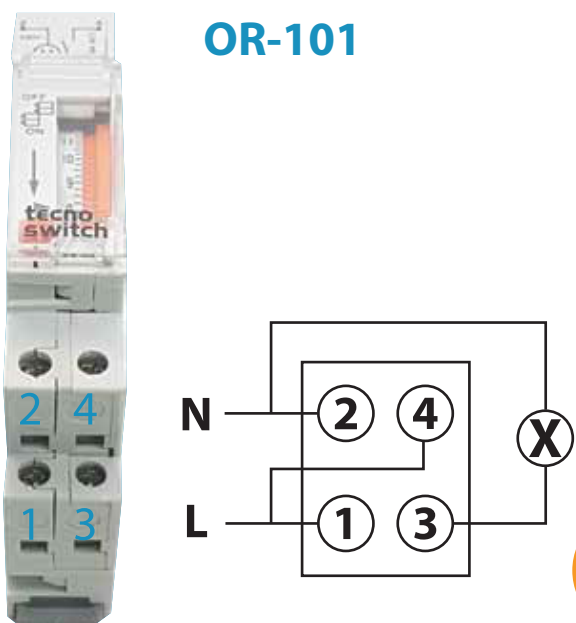
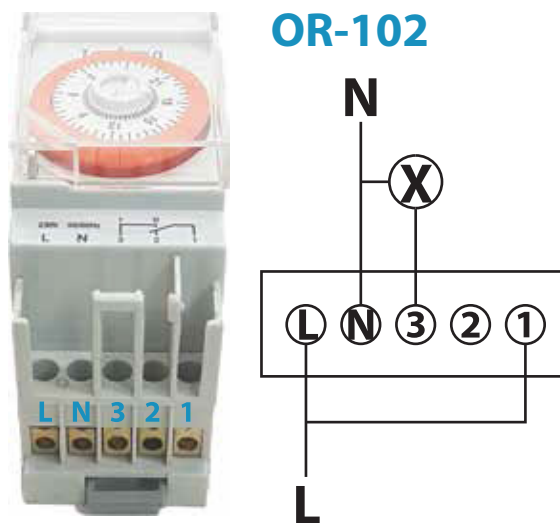
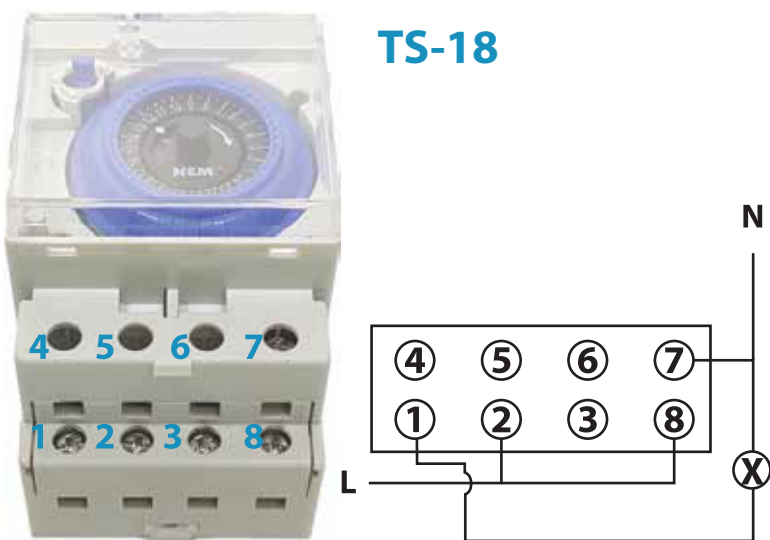
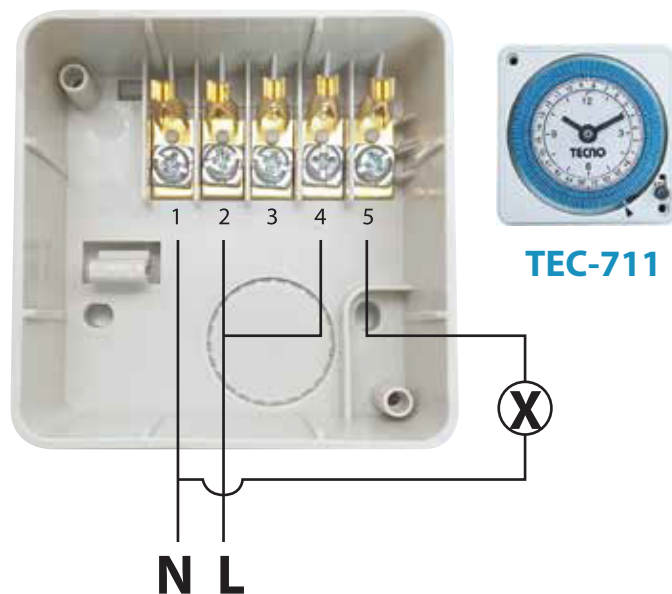
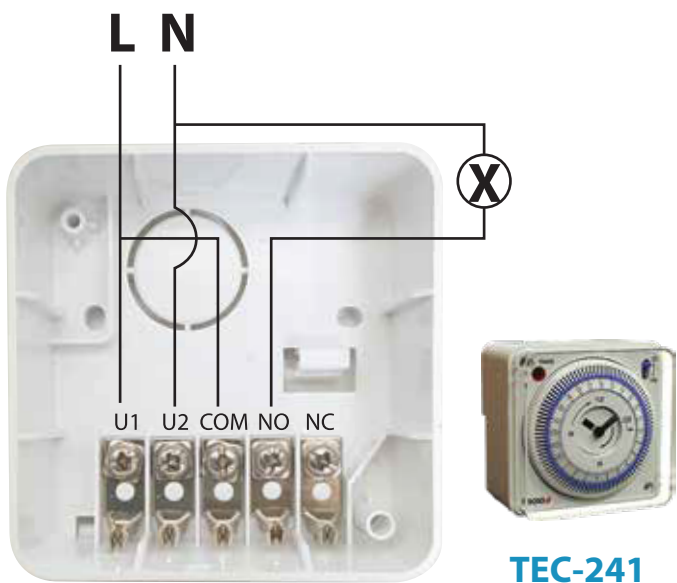



***ReyLuc***

[www.oes.com.my](http://www.oes.com.my)



Type:

ONLINE ELECTRICAL SUPPLY

COPYRIGHT 2022