

HE30B/HE40B/HE50B

Shaft rotary encoder

- Wide power supply voltage range
(5 – 12 / 12 – 24 V DC)
- Various output specification
- Simple installation structure



Suffix code

Model		Code				Description
HE	<input type="checkbox"/> - <input type="checkbox"/>	<input type="checkbox"/>	<input type="checkbox"/>	<input type="checkbox"/>	<input type="checkbox"/>	Shaft rotary encoder (Incremental)
Dimension	30B	4				Outer diameter : Ø 30 mm axis : Ø 4 mm
	40B	6				Outer diameter : Ø 40 mm axis : Ø 6 mm
		8				Outer diameter : Ø 40 mm axis : Ø 8 mm optional : (Option)
	50B	8				Outer diameter : Ø 50 mm axis : Ø 8 mm
Number of pulse		*				Refer to the pulse code chart(resolving power)
Output signal			2			A, B phase output
			3			A, B, Z phase output
			3C			A, B, \bar{Z} phase output
			4			A, \bar{A} , B, \bar{B} phase output
			6			A, \bar{A} , B, \bar{B} , Z, \bar{Z} phase output
Output circuit		N	24			NPN voltage output (12 – 24 V DC)
			12			NPN voltage output (5 – 12 V DC)
		O	24			NPN open collector output (12 – 24 V DC)
			12			NPN open collector output (5 – 12 V DC)
		T	24			Totem pole output (12 – 24 V DC)
			12			Totem pole output (5 – 12 V DC)
		L	5			Line Driver output (5 V DC)
			12			Line Driver output (12 V DC) – Apply only for HE40B, HE50B
24				Line Driver output (24 V DC) – Apply only for HE40B, HE50B		

Pulse code chart (Resolving power)

Model classification	Number of pulse per 1 revolution
HE-30B	100, 200, 360, 500, 1000, 1024
HE-40B	*1, *2, *5, 10, *12, 15, 20, 25, 30, 40, 45, 50, 60, 75, 100, 120, 125, 150, 192, 200, 240, 250,
HE-50B	256, 300, 360, 400, 500, 512, 600, 800, 1000, 1024, 1200, 1500, 1800, 2000, 2048, 2500

(Note) A and B phase only can be generated with * mark(Line drive output : A, \bar{A} , B, \bar{B} , phase)

Pulses other than the pulses in the chart are order made product

Specification

Electrical specification

Phase difference on output	Phase difference between the phase A and B : $T/4 \pm T/8$ (1 cycle of A is T)	
Response speed	200 KHz max.	
Rated voltage	Voltage output	※ By the suffix code
	Open collector	5 - 12 V DC $\pm 5\%$
	Totem pole output	12 - 24 V DC $\pm 5\%$
	Line drive	HE30B
HE40B/HE50B		5 / 12 / 24 V DC $\pm 5\%$
Current consumption	60 mA max (no load)	
Connection type	Cable extended type	
Control output	NPN voltage output	Load voltage : 30 V max, load current : 30 mA max
	NPN open collector	Remaining voltage : 0.4 V max
	Totempole	LOW (load current : 30 mA max, remaining voltage : 0.4 V DC max) HIGH (load current : 10 mA max, remaining voltage : rated voltage above -2.5 V min)
	LineDriver	LOW (load current : 20 mA max, 0.4 V DC max) HIGH (load current : 20 mA max, remaining voltage : rated voltage above 2.5V min)
Response time	Voltage output	1 μ s max (wire length : 1.5 m, sinking current = 30 mA)
	Open collector	
	Totempole	1 μ s max (wire length : 1.5 m, sinking current = 10 mA max.)
	LineDriver	1 μ s max (wire length : 1.5 m, sinking current = 30 mA max.)



Mechanical specification

Model	HE30B (Ø30)	HE40B (Ø40)	HE50B (Ø50)
Starting torque	2×10^{-3} N · m max	4×10^{-3} N · m max	7×10^{-3} N · m max
Moment of inertia	2×10^{-6} kg · m ² max	4×10^{-6} kg · m ² max	8×10^{-6} kg · m ² max
Permissible shaft loading	Radial : 15 N within	Radial : 30 N within	Radial : 50 N within
	Thrust : 10 N within	Thrust : 20 N within	Thrust : 30 N within
Max permissible revolution	5,000 r/min		

Environmental specification

Model	HE30B (Ø30)	HE40B (Ø40)	HE50B (Ø50)
Insulation resistance	100 MΩ min (between the terminal and case 500 V DC mega standard)		
Dielectric strength	800 V AC (for 1 min in 60 Hz between the terminal and case)		
Vibration resistance	10 – 55 Hz (period for 1 min), double amplitude : 1.5 mm, for 2 hour each in X, Y and Z directions		
Shock resistance	490 ٪ max		735 ٪ max
Ambient temperature	-10 ~ 70 °C (No icing allowed), when storing : -25 ~ 85 °C		
Ambient humidity	35 ~ 85 % RH		
Cable	5 P, Ø5.0 mm, Length: 1.5 m, Shield cable (HE40B, HE50B option : 2 m, 8 m, 10 m) (Line drive type : 8P, Ø5.0 mm, Length : 1.5 m, Shield cable)		
Accessory	Ø 4.0 mm coupling	Ø 6.0 mm or Ø 8.0 mm coupling	Ø 8.0 mm coupling
Weight	Approx. 120 g	Approx. 170 g	Approx. 200 g

Input/output circuit

NPN voltage output

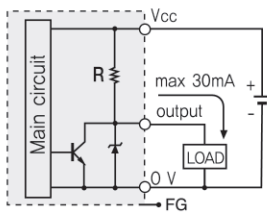

NPN open collector output

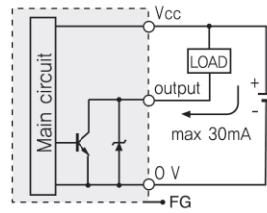

Totempole output (Corresponds to the either power output or open collector output)

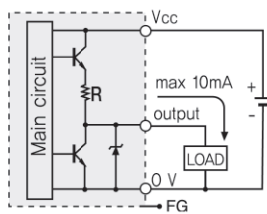
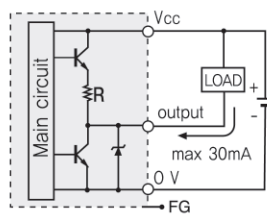



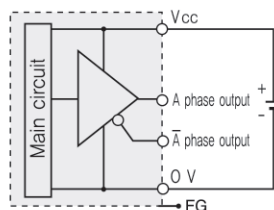



LineDriver output



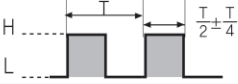



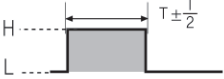



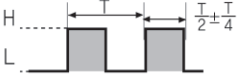
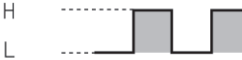

※ For the output circuit, phases A, B and Z are same (Line drive output is A, \bar{A} , B, \bar{B} , Z, \bar{Z})

Output wave form

■ NPN voltage output, NPN open collector output, Totem Pole output

output	Clockwise(CW)	Counter clockwise(CCW)
OUT A		
OUT B		
OUT Z		

■ Line Driver output

output	Clockwise(CW)	Counter clockwise(CCW)
OUT A		
OUT \bar{A}		
OUT B		
OUT \bar{B}		
OUT Z		
OUT \bar{Z}		

* Clockwise (CW) : Turning in the clockwise direction when looking at from the shaft of the product.

* Counter clockwise(CCW) : Turning in the counter clockwise direction when looking at from the shaft of the product.



Dimension (Unit : mm)

HE30B (Ø30)

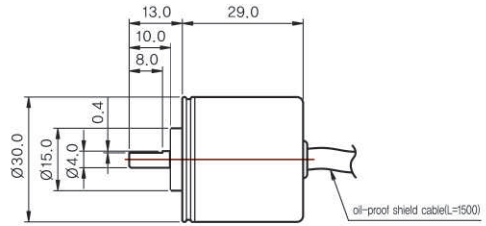
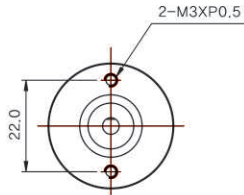

HE40B (Ø40)

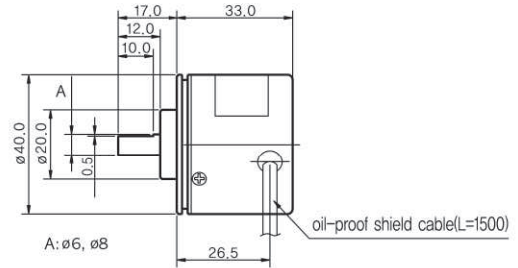
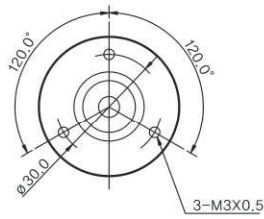

HE50B (Ø50)

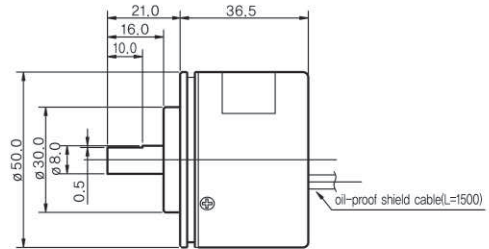
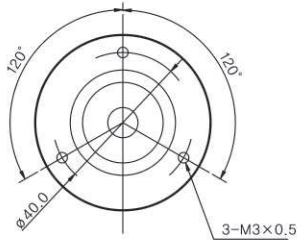

RB Ø50

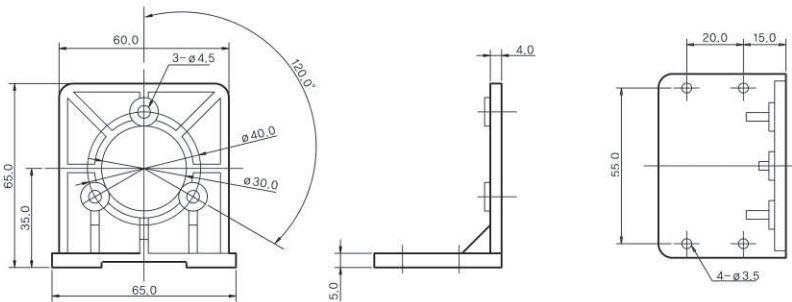

Connection diagram

Ø30 axis

- Voltage output, Totem Pole output, open collector output ■ Line driver output

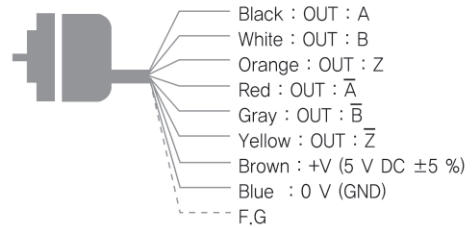

Ø40 axis

- Voltage output, Totem Pole output, open collector output ■ Line driver output

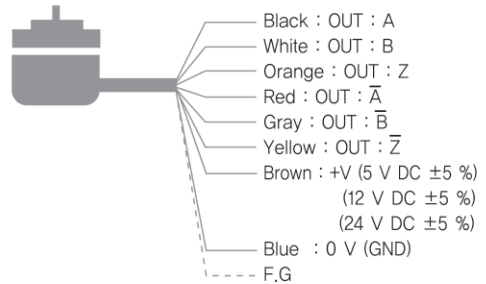
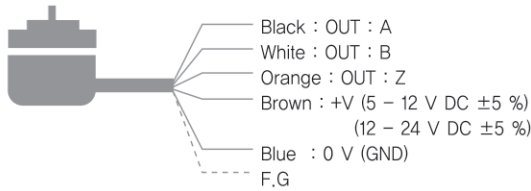

H
 Rotary Encoder

Ø50 axis

- Voltage output, Totem Pole output, open collector output ■ Line driver output

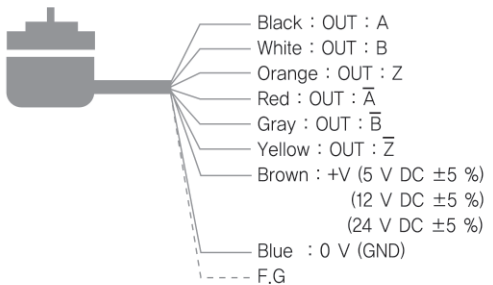

※ Please insulate the wires that are not used

※ Metal case of encoder and shield line must be earthed (F,G)