

Long-distance Separate-amplifier Proximity Sensors

ES Series

Features

- Detecting distance twice that of conventional sensors
- Detecting distance easily adjustable
- Wide range of sensor head types available
- Built-in alarm output

Detecting Distance

Shielded – Up to 8 mm

Non-shielded – Up to 70 mm



Description

Long detecting distance

A separate amplifier gives the ES Series twice the detecting distance of self-contained proximity sensors.

Detecting distance can be easily adjusted

The ES Series doesn't need precise adjustments to sensor position during setup. You can adjust the detecting distance using the adjustment trimmer after the sensor head is installed or during operation, when necessary. Because of its small hysteresis, the ES Series can detect minute height differences of continuously moving objects.

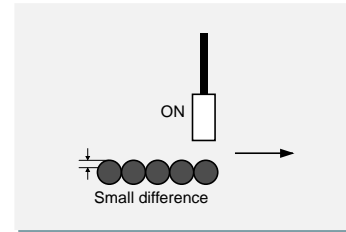

Dust cover (ES-X38)

The ES-X38 is equipped with a dust cover to protect the amplifier. The hinged cover remains on the amplifier when opened or closed.



17 models of sensor heads available

Sensor heads are available in sizes ranging from 2.8 mm to 90.0 mm in diameter.

- **Protected cable (EH-305S/308S/110S)**

The sensor cable is encased in a stainless steel spiral tube to prevent breakage.



- **Compact size (EH-402)**

The smallest ES Series proximity sensor, with a sensor head 2.8 mm in diameter, offers the maximum detecting distance of 7 mm.



- **Space-saving (EH-614A)**

The ES Series thin-type sensor is only 4.8 mm thick, enabling it to be installed in areas of limited space.



- **Resistant to welding spatter (optional)**

The Teflon® cap protects the sensor head (EH-308/110/114) from welding spatters.



- **Oil-resistant (EH-108)**

Precision-machined stainless steel and a special sealing mechanism makes the EH-108 highly resistant to oil.



Applications

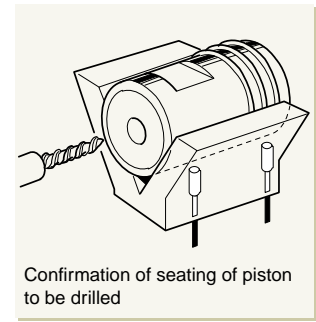
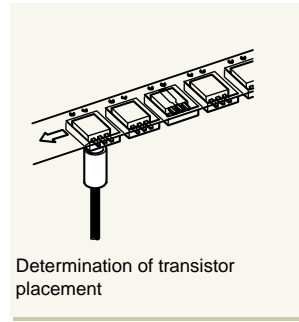
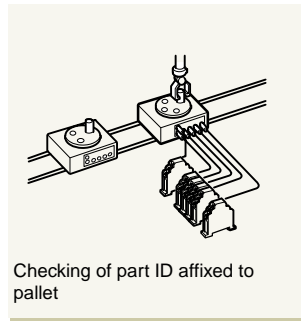
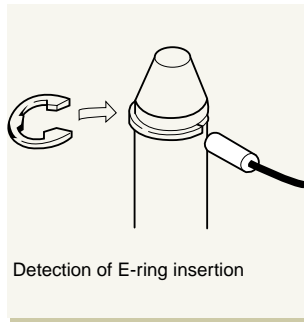

Selection Chart



Sensor head

Type	Size	Shape	Detecting distance	Model	
Shielded	Cylindrical		1.2 mm (0.6 mm)	EH-302	
			2 mm (0.8 mm)	EH-303A	
			3 mm (1 mm)	EH-305	
	Cylindrical, with spiral tube	5.4 mm dia.		3 mm (1 mm)	EH-305S
	Cylindrical	8 mm dia.		5 mm (2 mm)	EH-308
	Cylindrical, with spiral tube	8 mm dia.		5 mm (2 mm)	EH-308S
	Threaded, oil-resistant	M8		2.5 mm (1.5 mm)	EH-108
	Threaded	M10		5 mm (2 mm)	EH-110
	Threaded, with spiral tube	M10		5 mm (2 mm)	EH-110S
	Threaded	M14		8 mm (5 mm)	EH-114
	Thin	t=4.8 mm		8 mm (5 mm)	EH-614A
Non-shielded	Cylindrical		7 mm (3 mm)	EH-402	
	Cylindrical, threaded		13 mm (6 mm)	EH-416	
			18 mm (9 mm)	EH-422	
			25 mm (12 mm)	EH-430	
			36 mm (18 mm)	EH-440	
	Cylindrical	90 mm dia.		70 mm (35 mm)	EH-290

Stable detecting distance Maximum detecting distance

- 1 Photoelectric Sensors
- 2 Safety Light Curtains
- 3 Proximity Sensors
- 4 Pressure Sensors
- 5 Programmable Logic Controllers
- 6 Counters, Control Units
- 7 High-Precision Sensors
- 8 Vision Systems
- 9 Bar Code Readers
- 10 Displacement Sensors
- 11 Thinbeam Measuring Instruments
- 12 Analog Sensor Controllers
- 13 Video Microscope
- 14 Technical Guide

Amplifier

Shape	Power supply	Output	Output mode	Model
	10 to 28 VDC	NPN 200 mA (40 V) max.	N.O./ N.C. selectable	ES-32DC
	12 to 24 VDC	NPN 100 mA (40 V) max.	N.O./ N.C. selectable	ES-X38

Specifications

Sensor head

Type	Shielded				
	Cylindrical				Threaded
Model	EH-302	EH-303A	EH-305	EH-308	EH-110
Stable detecting range	0 to 0.6 mm	0 to 0.8 mm	0 to 1 mm	0 to 2 mm	0 to 5 mm
Maximum detecting distance	1.2 mm	2 mm	3 mm	5 mm	8 mm
Detectable object	Ferrous metals (see Characteristics for nonferrous metals)				
Standard target (iron, t=1 mm)	5 x 5 mm	5 x 5 mm	5 x 5 mm	10 x 10 mm	10 x 10 mm
Repeatability	0.002 mm	0.002 mm	0.002 mm	0.005 mm	0.005 mm
Hysteresis	0.04 mm	0.05 mm	0.05 mm	0.04 mm	0.04 mm
Temperature fluctuation	±10% max. (EH-302: -10 to +20%) of detecting distance at +23°C (-10 to +60°C)				
Enclosure rating	IP-67	IP-67	IP-67	IP-67	IP-67
Ambient temperature	-10 to +60°C	-10 to +60°C	-10 to +60°C	-10 to +60°C	-10 to +60°C
Weight (including nuts and 3-m cable)	Approx. 29 g	Approx. 38 g	Approx. 45 g	Approx. 47 g	Approx. 55 g

Type	Shielded		
	Threaded	Thin	Oil-resistant
Model	EH-114	EH-614A	EH-108 ¹
Stable detecting range	0 to 5 mm	0 to 5 mm	0 to 1.5 mm
Maximum detecting distance	8 mm	8 mm	2.5 mm
Detectable object	Ferrous metals (see Characteristics for nonferrous metals)		
Standard target (iron, t=1 mm)	15 x 15 mm	15 x 15 mm	10 x 10 mm
Repeatability	0.005 mm	0.005 mm	0.005 mm
Hysteresis	0.05 mm	0.05 mm	0.07 mm
Temperature fluctuation	±10% max. of detecting distance at +23°C (-10 to +60°C)		
Enclosure rating	IP-67	IP-67	IP-67
Ambient temperature	-10 to +60°C	-10 to +60°C	-10 to +60°C
Weight (including nuts and 3-m cable)	Approx. 62 g	Approx. 57 g	Approx. 51 g

1. Not designed for immersed use.

Type	Shielded; Spiral tube			Non-shielded	
	Cylindrical		Threaded	Cylindrical	Cylindrical and threaded
Model	EH-305S	EH-308S	EH-110S	EH-402	EH-416
Stable detecting range	0 to 1 mm	0 to 2 mm	0 to 2 mm	0 to 3 mm	0 to 6 mm
Maximum detecting distance	3 mm	5 mm	5 mm	7 mm	13 mm
Detectable object	Ferrous metals (see Characteristics for nonferrous metals)				
Standard target (iron, t=1 mm)	5 x 5 mm	10 x 10 mm	10 x 10 mm	10 x 10 mm	20 x 20 mm
Repeatability	0.002 mm	0.005 mm	0.005 mm	0.002 mm	0.012 mm
Hysteresis	0.05 mm	0.04 mm	0.04 mm	0.04 mm	0.05 mm
Temperature fluctuation	±10% max. (EH-402: +30%, -10% max.) of detecting distance at +23°C (-10 to +60°C)				
Enclosure rating	IP-67	IP-67	IP-67	IP-67	IP-67
Operation temperature	-10 to +60°C	-10 to +60°C	-10 to +60°C	-10 to +60°C	-10 to +60°C
Weight (including nuts and 3-m cable)	Approx. 76 g	Approx. 88 g	Approx. 100 g	Approx. 28 g	Approx. 72 g

Type	Non-shielded			
	Cylindrical and threaded			Cylindrical
Model	EH-422	EH-430	EH-440	EH-290
Stable detecting range	0 to 9 mm	0 to 12 mm	0 to 18 mm	0 to 35 mm
Maximum detecting distance	18 mm	25 mm	36 mm	70 mm
Detectable object	Ferrous metals (see Characteristics for nonferrous metals)			
Standard target (iron, t=1 mm)	25 x 25 mm	30 x 30 mm	40 x 40 mm	150 x 150 mm
Repeatability	0.02 mm	0.025 mm	0.037 mm	0.075 mm
Hysteresis	0.06 mm	0.08 mm	0.1 mm	0.2 mm
Temperature fluctuation	±10% max. (EH-402: +30%, -10% max.) of detecting distance at +23°C (-10 to +60°C)			
Enclosure rating	IP-67	IP-67	IP-67	IP-67
Operation temperature	-10 to +60°C	-10 to +60°C	-10 to +60°C	-10 to +60°C
Weight (including nuts and 3-m cable)	Approx. 175 g	Approx. 225 g	Approx. 280 g	Approx. 650 g

Amplifier

Type	DC		
	NPN	ES-32DC	ES-X38
Power supply		10 to 28 VDC	12 to 24 VDC
Current/power consumption		18 mA max.	25 mA max.
Response time		1 ms max.	1 ms max.
Temperature fluctuation	±8% of detecting distance at +23°C (0 to +50°C)		
Sensitivity adjustment	15-turn trimmer		
Operation mode	N.C./N.O. (switch selectable)		
Indicator	Output: Red LED.		
Control output	NPN: 200 mA (40 V) max., Residual voltage: 1 V max.	NPN: 100 mA (40 V) max., Residual voltage: 1 V max.	
Disconnection alarm out put	NPN: 100 mA (40 V) max. Residual voltage: 1 V max.		
Leakage current (OFF time)	—		
Ambient temperature	0 to +50°C		
Weight	Approx. 48 g	Approx. 67g (including 2-m cable)	

- 1 Photoelectric Sensors
- 2 Safety Light Curtains
- 3 Proximity Sensors
- 4 Pressure Sensors
- 5 Programmable Logic Controllers
- 6 Counters, Control Units
- 7 High-Precision Sensors
- 8 Vision Systems
- 9 Bar Code Readers
- 10 Displacement Sensors
- 11 Thinbeam Measuring Instruments
- 12 Analog Sensor Controllers
- 13 Video Microscope
- 14 Technical Guide

Connections

ES-32DC

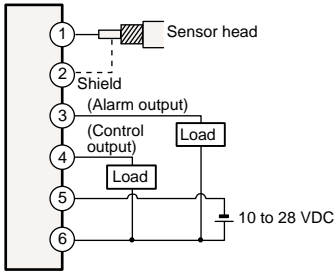

ES-X38

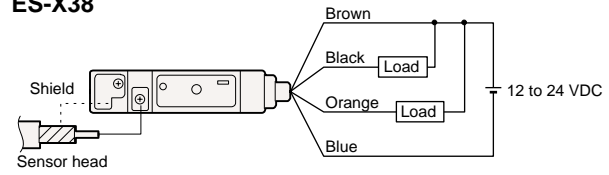

Input/Output Circuits

ES-32DC

NPN

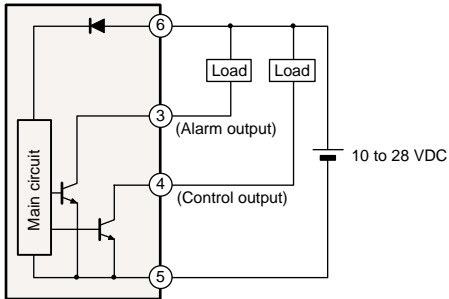

ES-X38

NPN

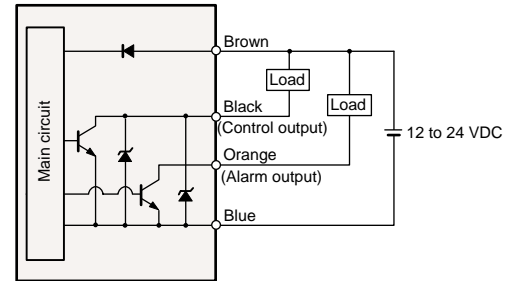

Adjustment

Both NEAR-ON and NEAR-OFF modes are available

NEAR-ON mode uses a normally open relay that closes when the target is detected. NEAR-OFF mode uses a normally closed relay that opens when the target is detected.

NEAR-ON operation

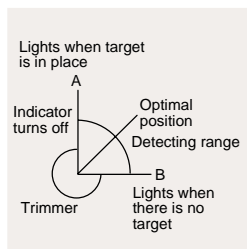

1. With the target in place, turn the trimmer clockwise and find point A at which the output indicator lights. (If the output indicator is already lit, turn the trimmer counterclockwise.)
2. With the target removed, again turn the trimmer clockwise and find point B at which the output indicator lights.
3. Set the trimmer midway between points A and B. The output circuit will now actuate when the output indicator lights.

NEAR-OFF operation

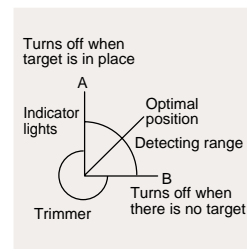

1. With the target in place, turn the trimmer clockwise and find point A at which the output indicator turns off. (If the output indicator is already off, turn the trimmer counterclockwise.)
2. With the target removed, again turn the trimmer clockwise and find point B at which the output indicator turns off.
3. Set the trimmer midway between points A and B. The output circuit will now actuate when the output indicator lights.

Operation mode selector switch

ES-32DC:

Use a screwdriver to set the position of the operation mode selector switch, located in the lower part of the controller.

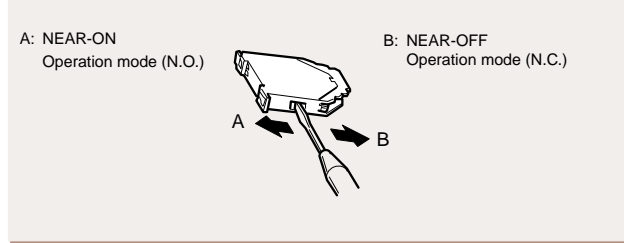

ES-X38:

Set the operation mode selector switch provided on the panel.

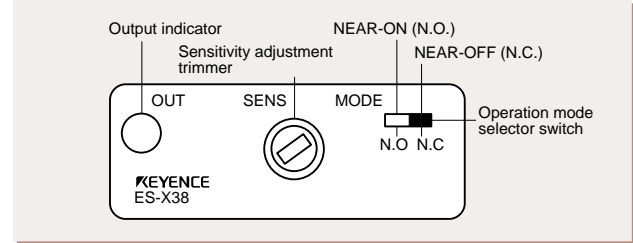

Characteristics

Detecting range (Typical)

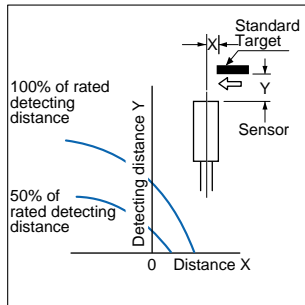

These graphs show variations in detecting distance measured by moving the target parallel to the sensor head for a distance 50% and 100% of the stable detecting distance.

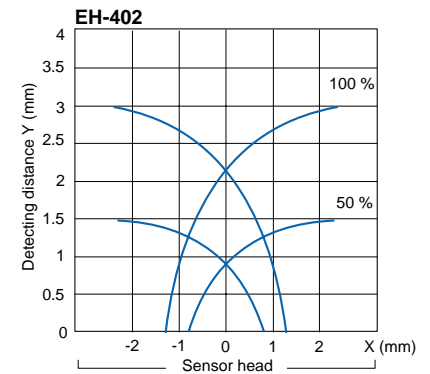
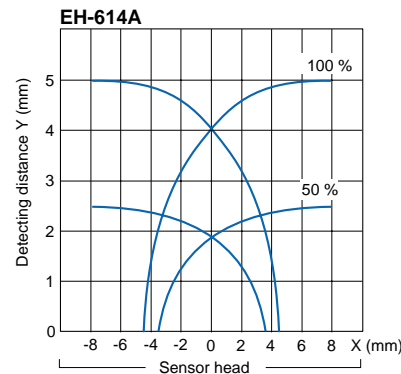
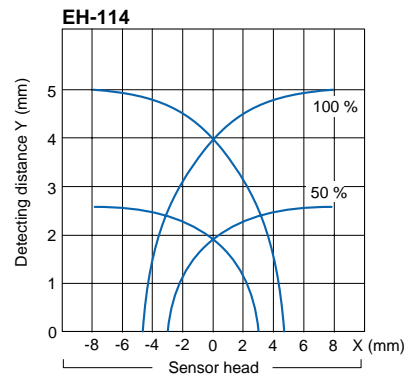
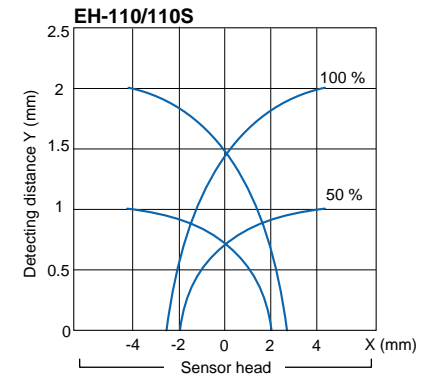
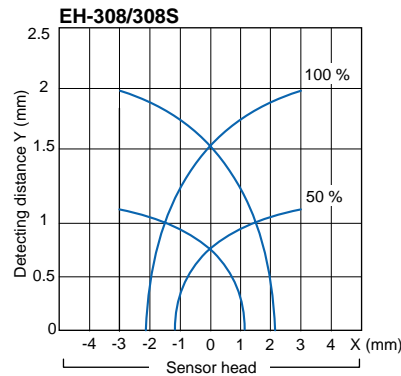
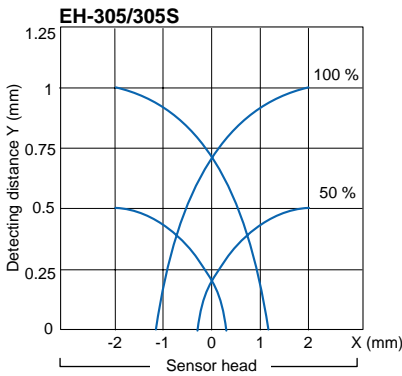
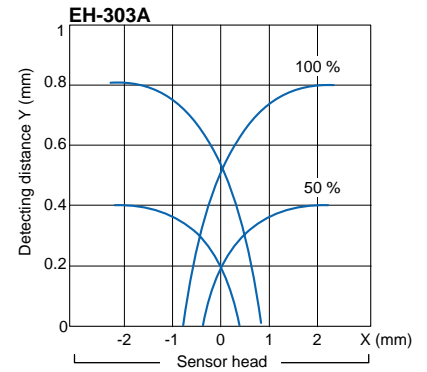
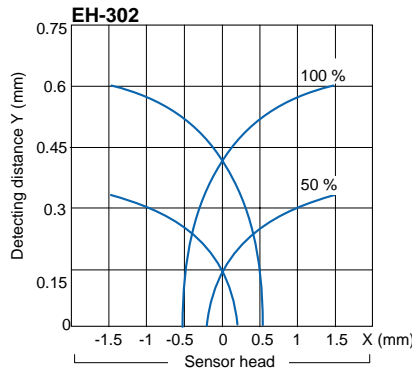

- 1 Photoelectric Sensors
- 2 Safety Light Curtains
- 3 Proximity Sensors
- 4 Pressure Sensors
- 5 Programmable Logic Controllers
- 6 Counters, Control Units
- 7 High-Precision Sensors
- 8 Vision Systems
- 9 Bar Code Readers
- 10 Displacement Sensors
- 11 Thinbeam Measuring Instruments
- 12 Analog Sensor Controllers
- 13 Video Microscope
- 14 Technical Guide

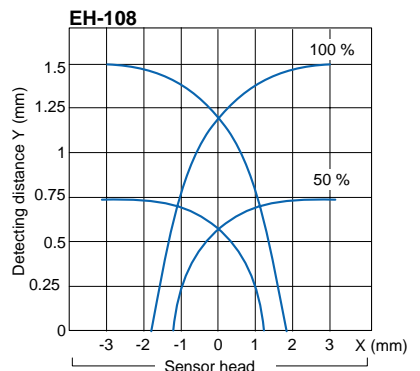
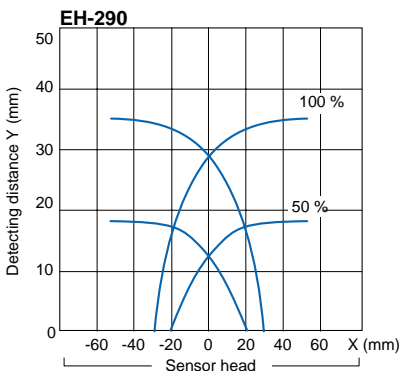
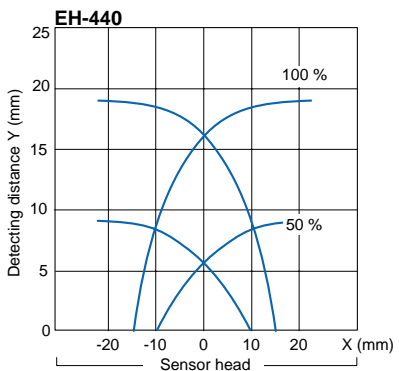
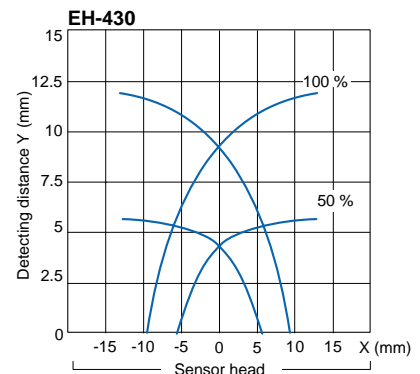
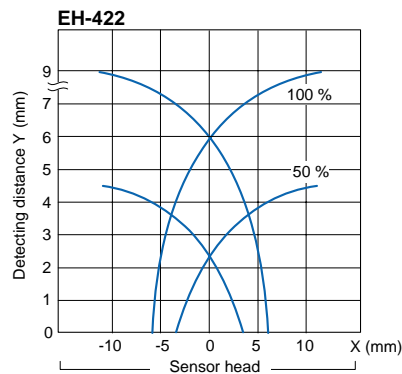
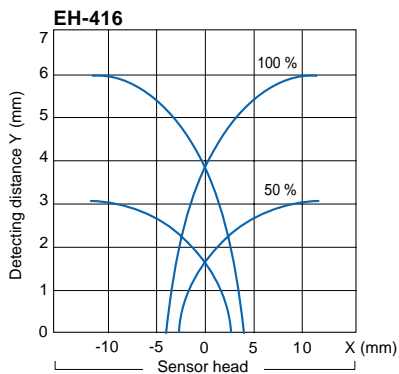

Detecting distance vs. size and material of target (Typical)

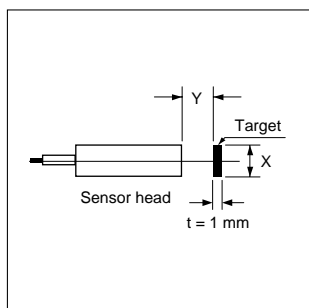

These graphs show variations in detecting distance (Y mm), obtained by using square metal plates (X x X x 1 mm, where X is varied) after adjusting the detecting distance of the sensor head to a stable detecting distance using the standard target.

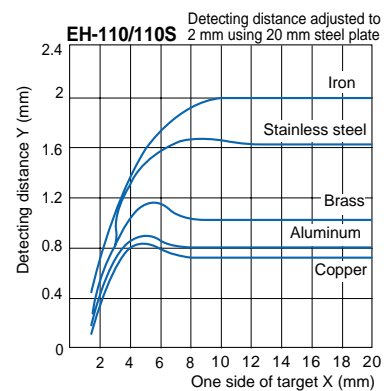
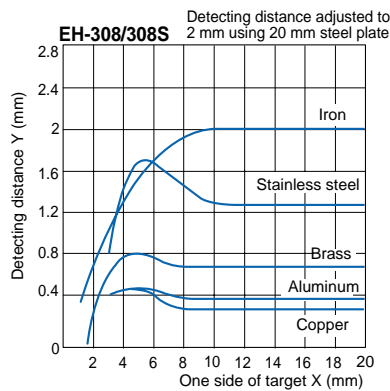
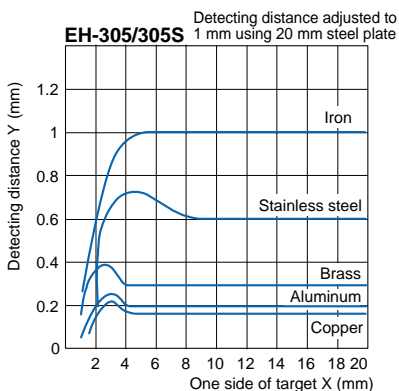
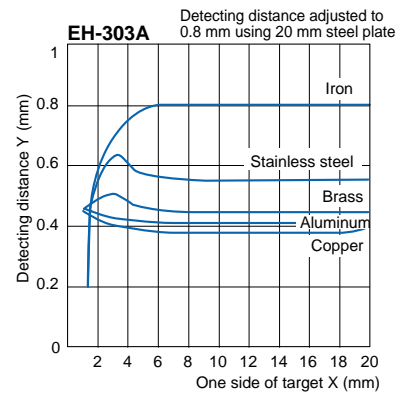
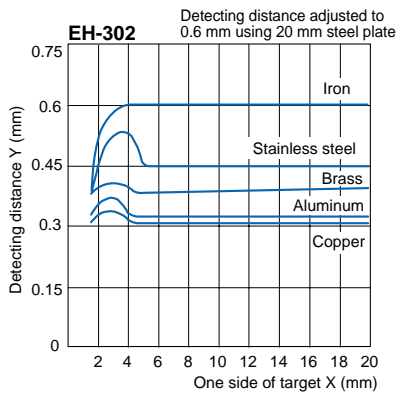

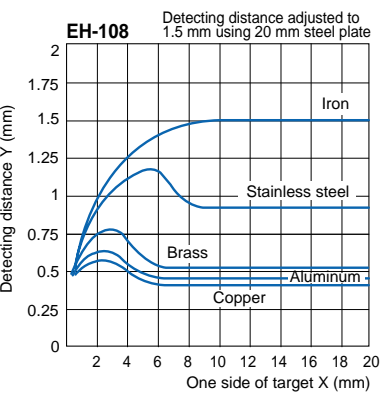
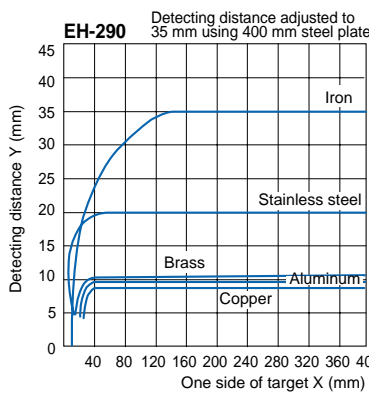
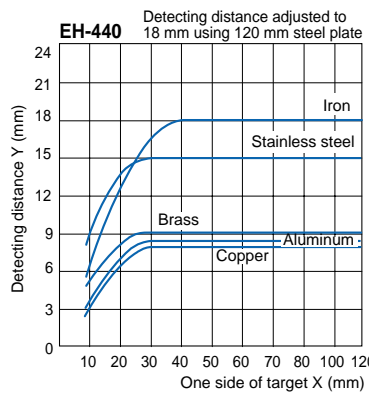
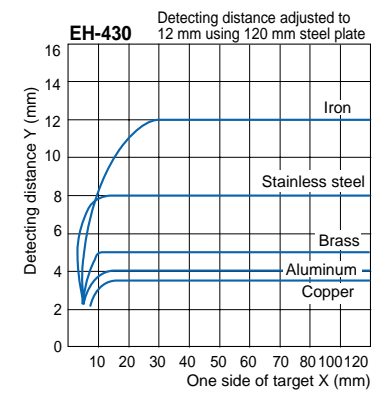
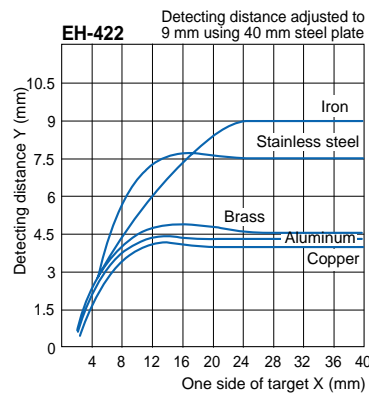
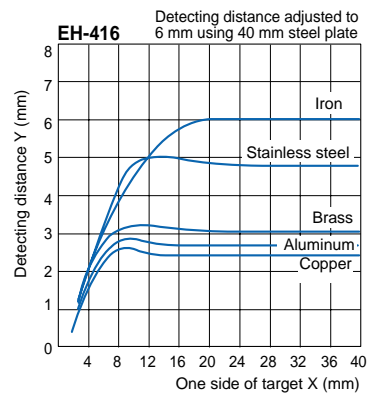
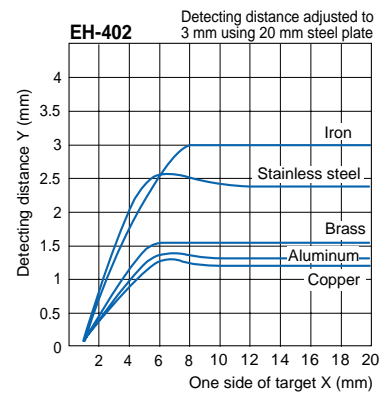
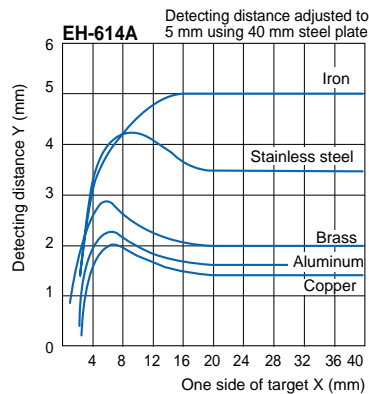
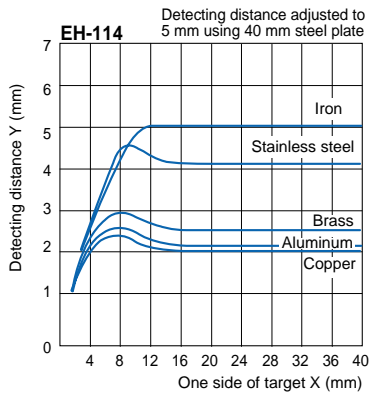

Hints on Correct Use

Mounting

- Cylindrical type
Secure the sensor head with a screw at a position 5 mm or more from the tip of the head. (Tightening torque: 2 N•m max.)
- Threaded type
When mounting the threaded-type sensor head, do not tighten beyond the torque specified in the following table.

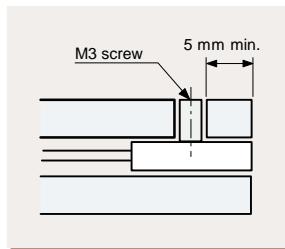

Model	Tightening torque
EH-108	8 N•m max.
EH-110	10 N•m max.
EH-114	20 N•m max.
EH-416	20 N•m max.
EH-422	10 N•m max.
EH-430	10 N•m max.
EH-440	10 N•m max.

- 1 Photoelectric Sensors
- 2 Safety Light Curtains
- 3 Proximity Sensors
- 4 Pressure Sensors
- 5 Programmable Logic Controllers
- 6 Counters/Control Units
- 7 High-Precision Sensors
- 8 Vision Systems
- 9 Bar Code Readers
- 10 Displacement Sensors
- 11 Tri-beam Measuring Instruments
- 12 Analog Sensor Controllers
- 13 Video Microscope
- 14 Technical Guide

Wiring

Use a coaxial cable to connect the sensor head to the amplifier. Limit the length of extension to within 10 m (5 m for models EH-302 and EH-402).

Surrounding metal

Shielded-type sensors can be flush-mounted in a metal base. Sensors of the non-shielded type, however, should be mounted according to the guidelines given below in order to minimize interference from the surrounding metal.

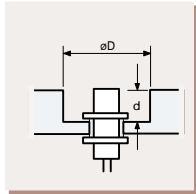

Model	D (mm min.)	d (mm min.)
EH-402	20	15
EH-416	30	10
EH-422	45	20
EH-430	70	25
EH-440	100	30
EH-290	260	30

Interference

When installing two or more sensors of the same model face-to-face or in parallel, separate by the distance specified in the following table to prevent interference.

Distance	Face-to-face (mm min.)	Parallel (mm min.)
Model		
EH-302	2 (1)	No space required
EH-303A	2 (1)	No space required
EH-305(S)	5 (3)	No space required
EH-308(S)	10 (7)	No space required
EH-110(S)	7 (4)	35 (no space required)
EH-114	11 (6)	39 (no space required)
EH-614A	11 (6)	64 (no space required)
EH-402	53 (12)	23 (11)
EH-416	11 (7)	115 (no space required)
EH-422	26 (9)	122 (no space required)
EH-430	41 (14)	250 (no space required)
EH-440	38 (29)	300 (no space required)
EH-108	7 (4)	No space required

[Note]

The above figures apply when the trimmer is turned to its optimal position for stable detection. The figures in parentheses apply when an optional interference prevention adapter is connected parallel to the sensor head (Except for ES-X38). Contact KEYENCE for further information.

Amplifier unit (ES-X38)

Sensor cable end treatment

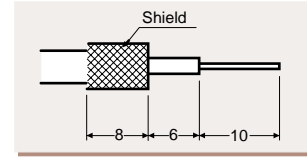

* Fold back the shielded cable over the sheath.

Sensor cable connections

To connect the sensor cable, insert the end of the cable through the entry port (1), tighten the screw (2), connect the core wire to the terminal (3), and then tighten the screw (3).

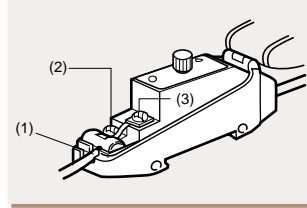

- For connections to the EH-422/430/440/290, contact KEYENCE for more information.

Mounting/dismounting the amplifier unit on DIN-rail or mounting bracket

Hook the rear of the amplifier unit on the DIN-rail. Push the amplifier unit forward to hook the front of the unit.

To dismount the amplifier unit, push the unit forward and unhook the front of the unit.

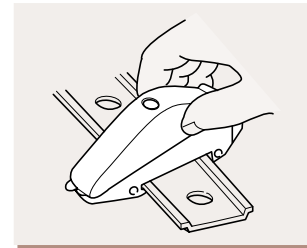

How to use the attached sticker

Write the sensor number on the rectangular sticker and stick it on the dust cover.

Stick the round sticker over the round cover hole if the sensitivity adjustment trimmer setting should not be changed.

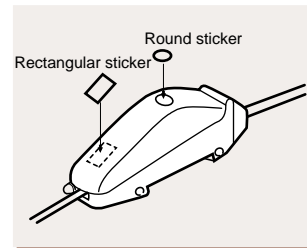

Dimensions

Unit: mm

Sensor head

EH-108

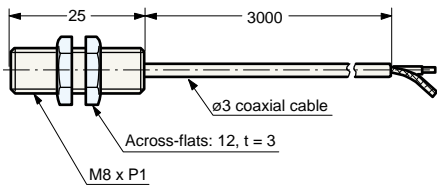

EH-302

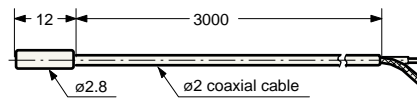

EH-110

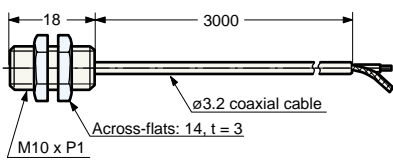

EH-303A

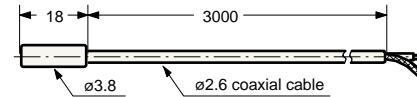

EH-110S

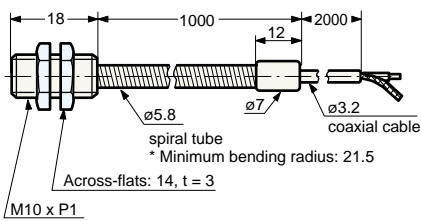

EH-305

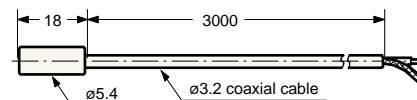

EH-114

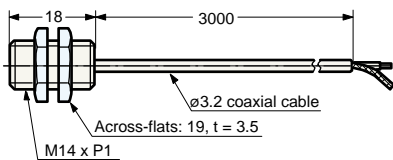

EH-305S

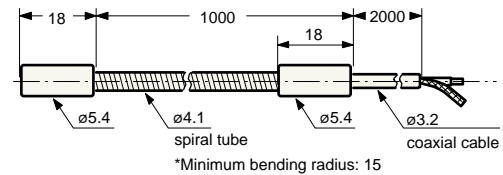

EH-290

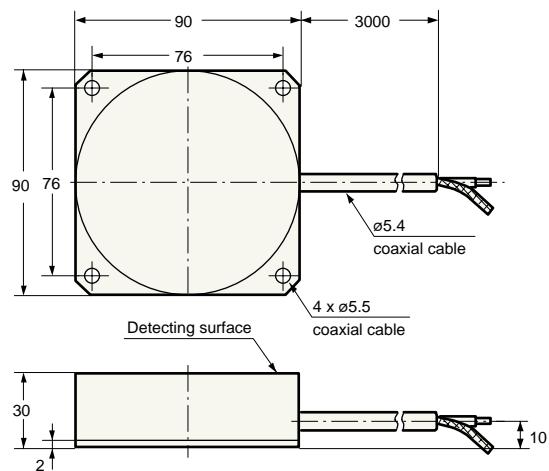

EH-308

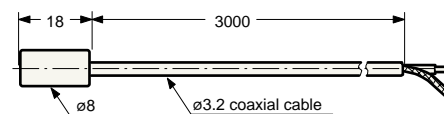

EH-308S

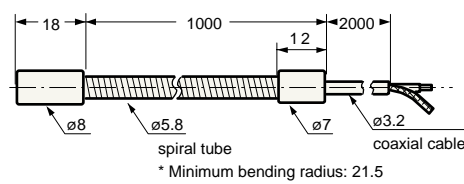

Photoelectric Sensors	1
Safety Light Curtains	2
Proximity Sensors	3
Pressure Sensors	4
Programmable Logic Controllers	5
Counters, Control Units	6
High-Precision Sensors	7
Vision Systems	8
Bar Code Readers	9
Displacement Sensors	10
Thru-beam Measuring Instruments	11
Analog Sensor Controllers	12
Video Microscope	13
Technical Guide	14

Unit: mm

EH-402

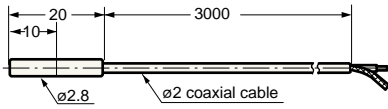

EH-416

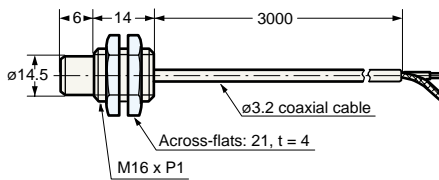

EH-422

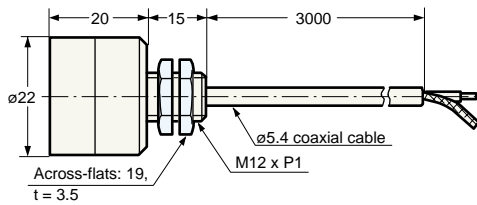

EH-430

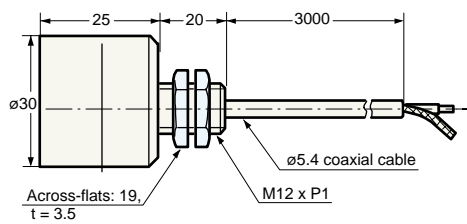

EH-440

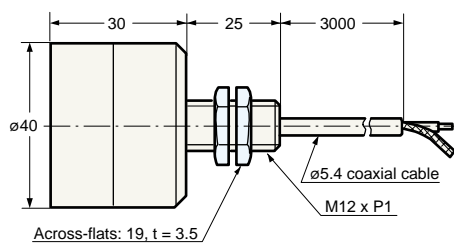

EH-614A

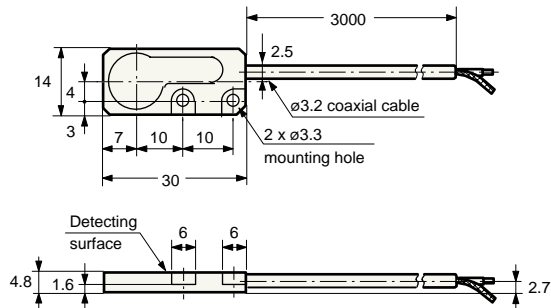

**Amplifier
ES-32DC**

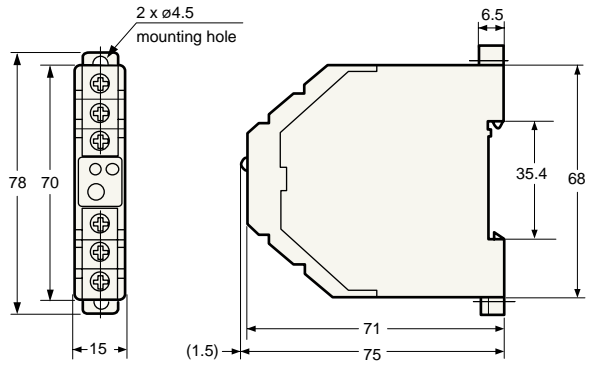

**Teflon® cap
(For protection against welding spatter)**

OP-3107 (for EH-114)

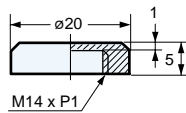

OP-3108 (for EH-110)

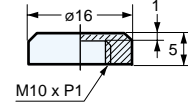

OP-3109 (for EH-308)

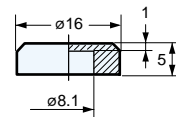

ES-X38

