

COMBIMASS®

Technical data

COMBIMASS® basic

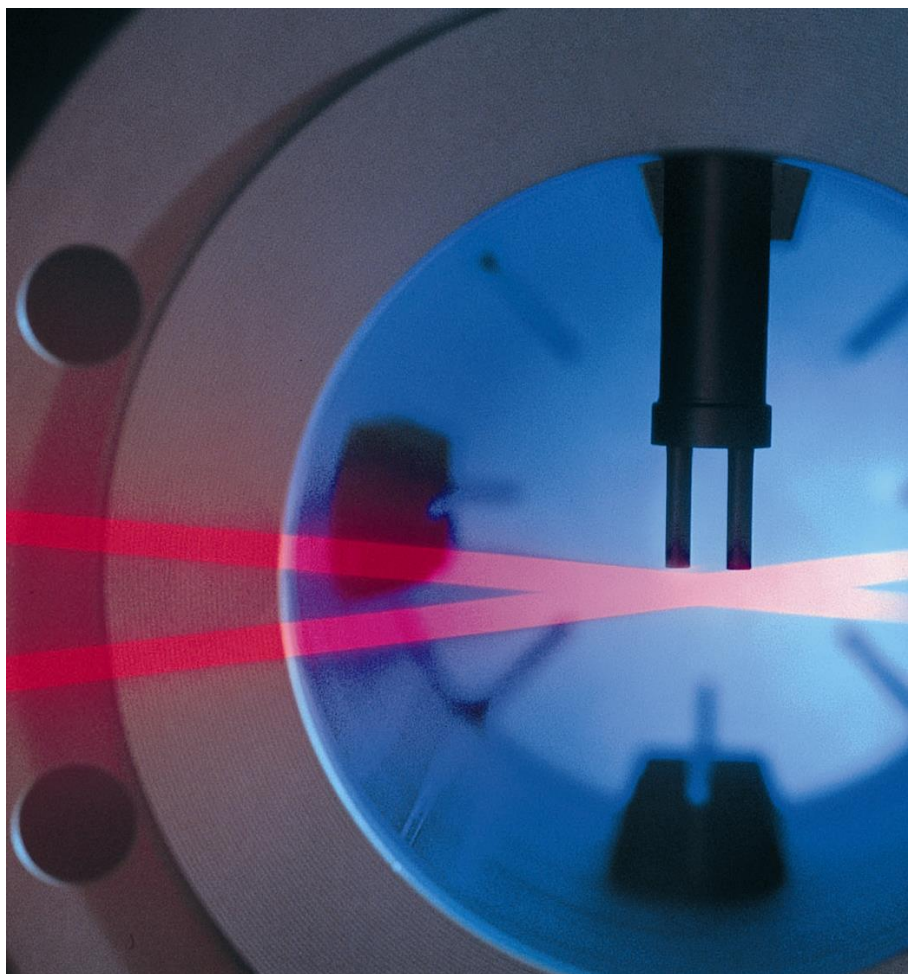

THE SYSTEM

The field transmitters of the COMBIMASS® series are suitable for flow rate measurement of compressed air and technical gases at medium temperatures up to 130°C. The flow transmitters apply thermal dispersion technology in order to measure directly the normal volumetric or gas mass flow, regardless of the operating pressure and temperature of the medium.

Even these basic flow meters of the COMBIMASS® series already perform fully digital signal processing. Important features of the transmitter electronics for the purposes of practical operation are the temperature compensation and the opportunity to select different measuring modes (choice between constant current or constant temperature principle).

The electronics of the COMBIMASS® basic is located in a compact aluminium enclosure. As an option for this type of enclosure a 8 digits LED display for indication of actual flow rate or totalized flow is available. As a low-cost version, the circuitry can also be installed in a simple ½ DIN aluminium housing. In such case installation of a LED display for field indication of the flow rate is not possible.

As an option, a remote graphic display for wall or switch cabinet installation may be installed. On this graphic display the actual flow rate as well as the totalized flow will be indicated at the same time. For transmission of the flow signal an isolated 4-20 mA analog output and a field selectable pulse output are available.

The flow transmitter can be assembled individually according to the specific application. Each flow meter will be tested prior to shipment and calibrated at our COMBIMASS® calibration Lab under actual operating conditions.

SMART FEATURES

- Thermal flow meter for direct measurement of normal volumetric or gas mass flows
- Flow rate measurement unaffected by pressure and temperature fluctuations
- Aluminium enclosure
- Excellent value for price
- Compact and rugged design for exceptional reliability
- Easy to install and service
- Unmatched accuracy due to digital signal processing
- Temperature compensated flow rate measurement
- Choice of different measuring modes
- Expandable due to modular design

APPLICATIONS

- Compressed air – flow rate measurement and balancing
- Technical gases, inert and supply gases such as N₂, Ar, He, ...

SPECIFICATIONS

Measuring principle	Gas flow measurement based on thermal dispersion technology
Applications	Compressed air, air, technical gases, inert gases, supply gases
Measured parameter	<ul style="list-style-type: none"> • Gas mass flow [kg/h] • Normal volumetric flow [Nm³/h] • Normal flow velocity [Nm/s]
Signal processing	Microprocessor based, fully digital signal processing
Measuring modes	<p>Constant current or constant temperature principle</p> <p><u>Note:</u> The measuring mode will be selected by our qualified technicians depending on the application requirements during calibration of the flow meter and may not be changed by the operator.</p>
Calibration	One calibration group with advanced temperature compensation
Enclosure	cylindrical enclosure, aluminum, Ø 50 mm
Protection class	IP 68
Ambient conditions	Ambient temperature -40° C to 80° C, relative humidity 80%
Power supply	<p>18 – 36 VDC</p> <p>Power supply via standard supply units possible</p>
Power consumption	max. 1.1 Watt
Reproducibility (electronics)	0.125% of reading
System accuracy (electronics)	0.25% of reading + 0.025% of full scale
Measuring accuracy	2.5% of reading + 0.2% of full scale (at the test bench) (depending on application and type of calibration)
Flow range	<p>0.46 – 46 Nm/s (standard)</p> <p>0.08 – 150 Nm/s (optional)</p>
Turndown ratio	10 : 1 to 100 : 1
Field display / control (optional)	<ul style="list-style-type: none"> • 8 digits, alphanumerical LED display for field indication of flow rate or totalized flow • Integrated totalizer • Control pad for field programming of the flow meter using a magnetic pin • Easy-to-use menu for transmitter set-up

SPECIFICATIONS

Graphic display (optional)	<ul style="list-style-type: none"> • Remote graphic display (wall or switch cabinet mounting) • Simultaneous indication of flow rate and totalized flow • Integrated totalizer • Touch pad for easy programming of the flow meter • Easy-to-use menu for transmitter set-up
Signal output (isolated)	<p>1 x analog output: 4-20 mA, active load < 400 Ohm 10 Bit resolution</p> <p>1 x impulse output: field selectable max. 2 impulse/s</p>
Choice of sensors	<p>Transmitter may be combined with different sensor of the COMBIMASS® series:</p> <p>Sensor geometry: 2-pin type Process temperature: max. 130°C Operating pressure: max. 40 bar Diameter of sensor rod: 12 mm, 18 mm Material: 1.4571 Approvals: PED test certificate, modules B+F or module G (optional) Certificates: 3.1B material certificate (optional) Process connection: compression fitting, 1.4571, Viton Hot tapping: manually actuated with ball valve</p>

INLET AND OUTLET STRAIGHT PIPE RUNS

General information To achieve high accuracy in flow rate measurement as specified, consideration of sufficient inlet and outlet straight pipe runs according to DIN ISO 5167-1 is crucial during installation of the flow transmitter. Reasonable measuring results can also be achieved with shortened inlet and outlet straight pipe runs according to the below specifications.

If sufficient inlet and outlet straight pipe runs are not available, please call factory. It might be possible to achieve the required measurement accuracy, if a special calibration can be carried out at our CAMASS® calibration centre by simulating the actual operating conditions, the range of flow rates and the piping.

Alternatively, the installation of a COMBIMASS® flow conditioner or the use of multiple sensors may allow to achieve accurate measuring results when space is restricted.

Reduction piece

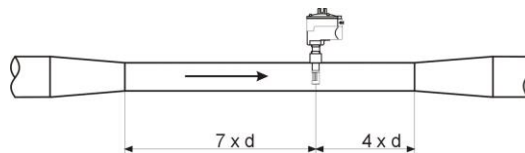

Extension piece

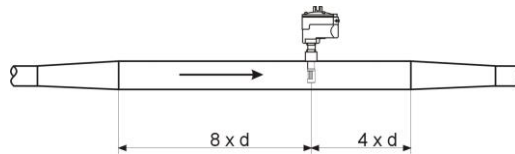

One 90° elbow

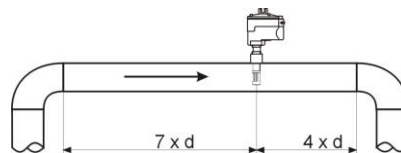

Two 90° elbows in one plane

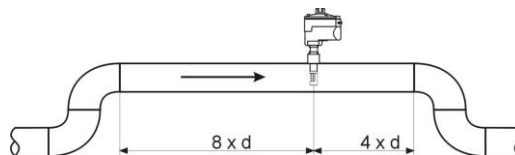

Two 90° elbows in two planes

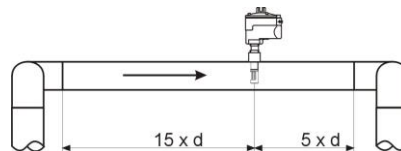

Three 90° elbows in three planes

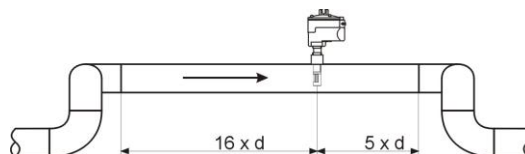

DIMENSIONS

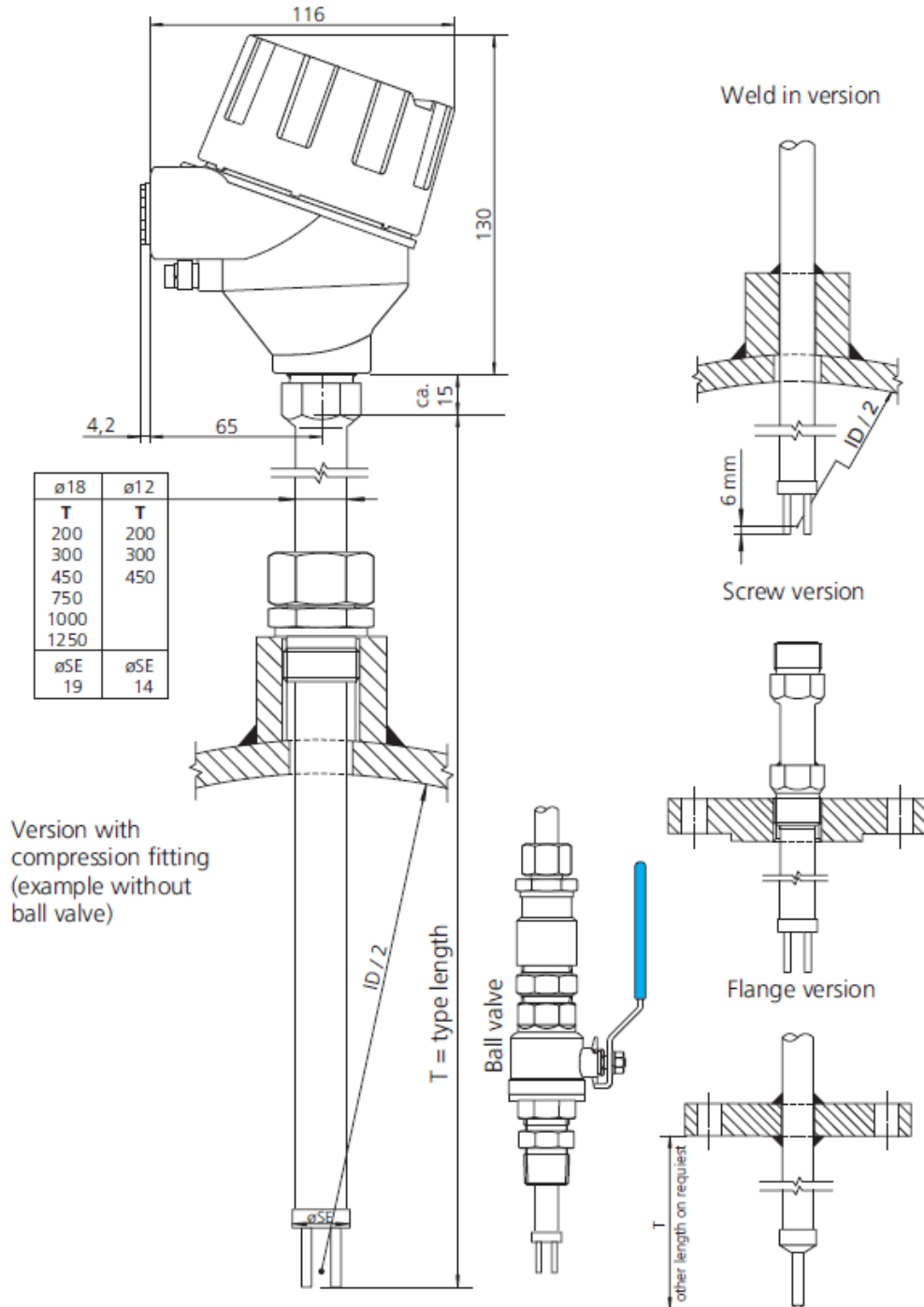

IMPRESSUM

BINDER GmbH
Buchbrunnenweg 18
89081 Ulm, Germany
Tel. +49 731 18998-0
Fax +49 731 18998-88

info@bindergroup.info
www.bindergroup.info

BIDE-M-D-COMBIMASS BASIC-EN-R07
Datenblatt COMBIMASS Basic