



**LAMANO**

Luxuria Tegulas

# LAMA GROUP LAMANO INSTALLATION GUIDE



**AUGUST 2015**



The function of this installation guide developed by Lama Group is to enable designers, specifiers, quantity surveyors, purchasers, contractors and other users to further understand Lama's installation methods and specifications. This installation manual guide applies only to roofs in Malaysia, Singapore, Brunei, Vietnam, Cambodia and Laos under the normal tropical climate conditions. Lama Roof Tiles in this document refers to the Lama ROMAN Profile.

This Installation Manual is the minimum standards for the installation standards of the Lama roof tiles but is not part of local standards or governmental requirements. In all situations where local building authority requirements are enforceable, its precedence should take place. The information and illustration provided in the Installation Manual is intended to be used with the judgement and experience of competent installers who needs to evaluate the significance and limitations of the materials contained and who will accept responsibilities for its applications. It is the duty and the responsibility of all users of this installation manual to find and obtain the latest edition of the manual, if any and must be used in conjunction with other relevant reliable standards or publications on the installation and fixing of standard concrete roof tiles.

The durability and the long term performance of a tiled roof depends to a large extend on the standards of the installation workmanship which will lead to leakages or high breakages should insufficient standards are applied. All installations using higher quality materials with higher level of insurance such as additional head lap or fastenings are allowed. Lama strongly suggests the installation of all Lama roof tiles using Lama manufactured or supplied roof accessories and cappings as these products are designed for, tested and proven to be used with our tiles, otherwise, may result in the void of warranties.

Should any unusual fixing situation arises and whereby this fixing is not illustrated in the installation manual, kindly please contact our staffs at any of our offices, branches or factories for further support.

Lama reserves the right to alter, remove or add to our product specifications as part of product or company operations improvements without prior notice. Specifications for products may differ between Malaysia and Vietnam, therefore, please obtain the correct version for your country. Lama Group disclaims any responsibility for the use of this document that directly or indirectly causes any injury towards any person or any damage in whatever manner, nor accepts any responsibility for any errors or omissions.



# Contents



CONTENTS PAGE-----	Page
1. Lamano Tile Specification -----	1
2. Roof Definition / Glossary -----	2
3. Tools Required For Installation -----	3
4. Setting Out -----	3
5. Battening and Eaves Fixing -----	4
6. Roof Pitch and Head Lap -----	5
7. Installation of Lamano Roof Tiles -----	6
8. Screwing of Roof Tiles -----	8
9. Laying and Cutting of Lamano Tiles -----	9
10. LAMANO Tile Accessories -----	10
11. Installation of Verges and Gable End Tile -----	11
12. Installation of Ridge Tile End -----	13
13. Ridge & Hip Preparation and Installation -----	13
14. Installation of Hip Starter -----	13
15. Installation of 2-way tiles -----	14
16. Installation of 3-way & 4-way apex tile -----	14
17. Installation of Valley Gutters -----	15
18. Walking on Roof -----	17
20. Weather Effects of Roof Tiles -----	17
21. Repairing & Replacement of Broken Tiles -----	18
22. Transfer, Stacking & Storage Of Roof Tiles At Site -----	18

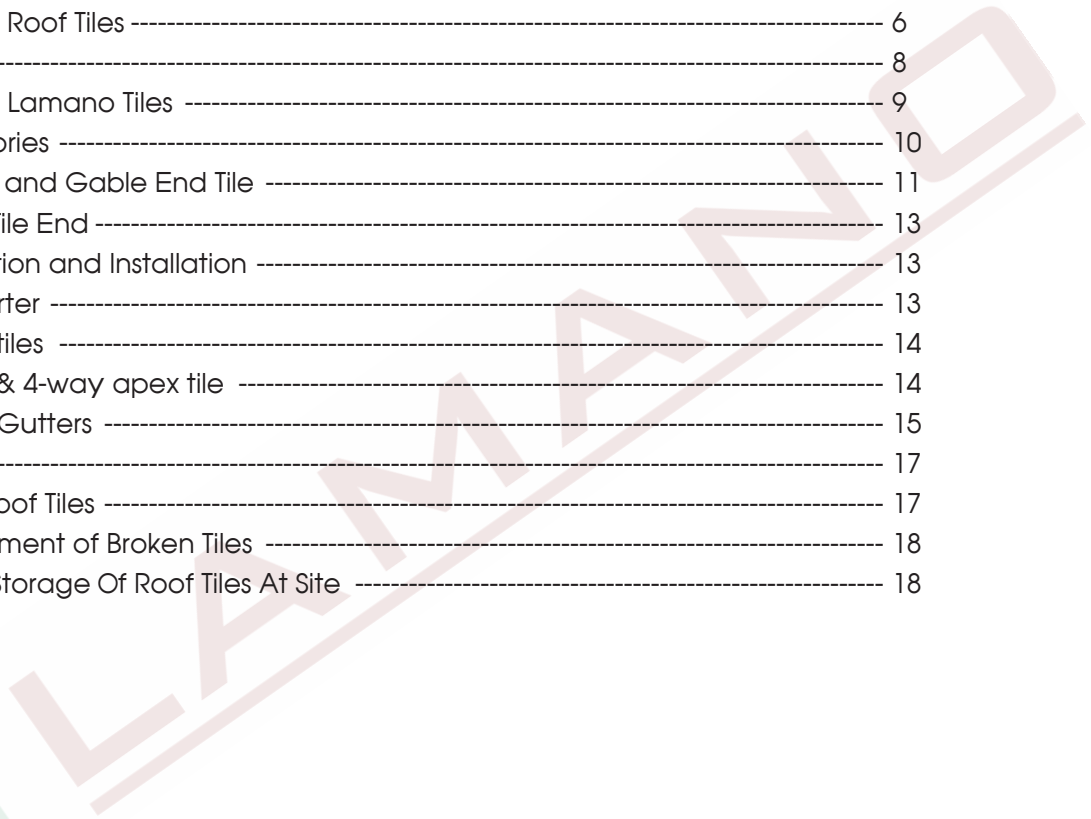



# 1. Lamano Tile Specification

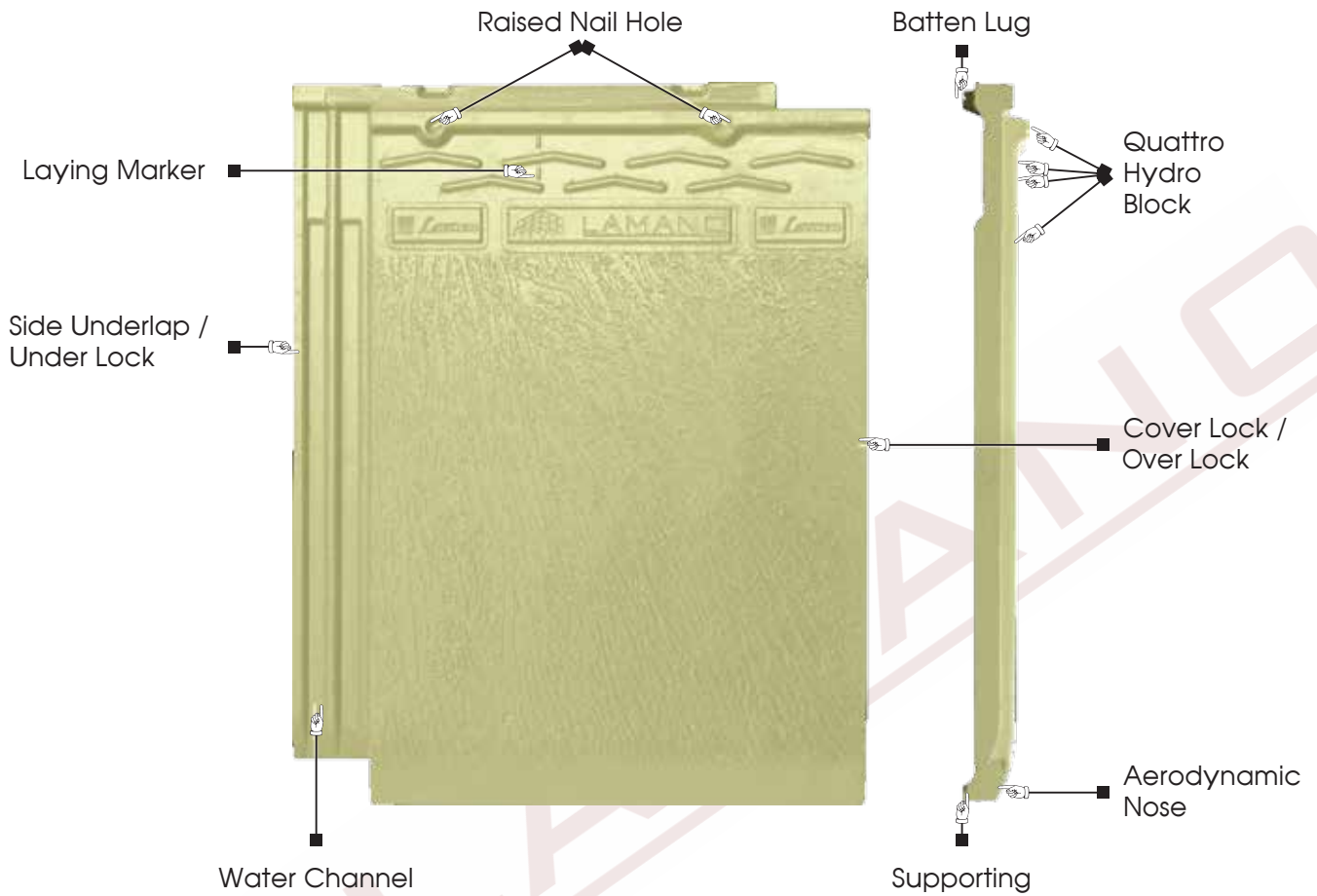

<b>Dimension (<math>\pm 1\text{mm}</math>)</b>	419mm x 347mm
<b>Batten Spacing</b>	300mm - 320mm
<b>Coverage</b>	10.4 pcs/m <sup>2</sup> (based on 100mm headlap)
<b>Material</b>	Highly Compacted Green Concrete
<b>Weight (Approx.)</b>	4.7kg
<b>Roof Pitch</b>	25° & Above As Low As 10° With Dual Layer Roofing System
<b>Laying Method</b>	Cross Bond / Staggered Only



## 2. Roof Definition / Glossary

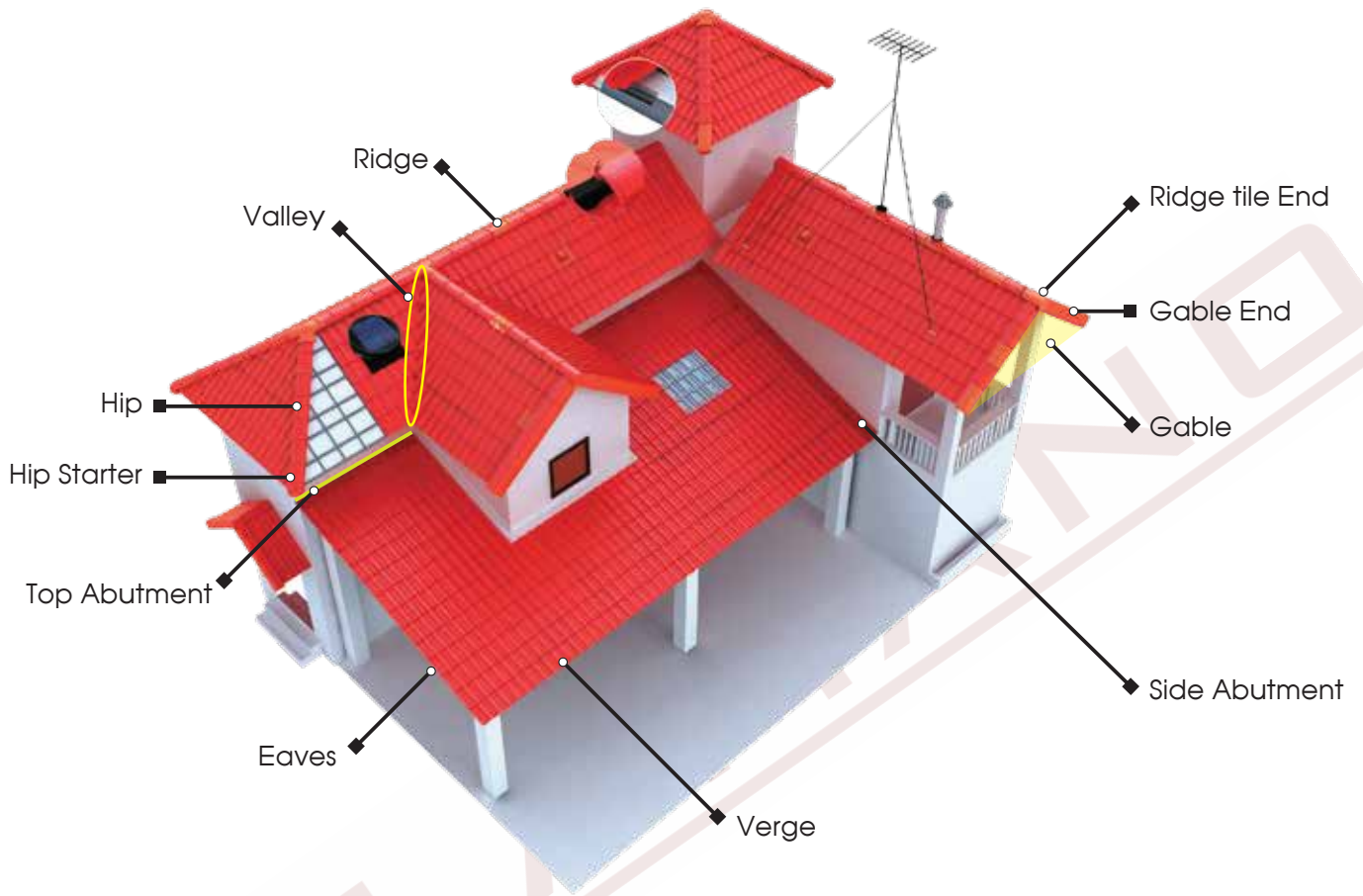



## 3. Tools Required For Installation



1. *Phillips Screwdriver*
2. *38mm screw*
3. *Lead pencil / Marker*
4. *Measuring tape*
5. *Measuring line*
6. *Phillips Wrench*
7. *Torqueable Drill*
8. *Angle Grinder with Diamond Cutting Wheel*

### INSTALLATION TIPS

#### Foundations

To have a safe, sustainable and beautiful roof, the structures and foundations of the building must meet the structural strength requirements.

#### Roof Structure Design

LAMANO Tiles are designed for straight and flat surface roofs and therefore, any roof curvatures will result in the tiles being laid unevenly with possible skewed or protruded joints, leading to leakages.

Wooden roof structures derived from good quality and matured wood are a tradition. High Quality lightweight roof systems which are designed by reputable and specialized softwares are also recommended, however, with the roof truss manufacturer's recommendations.

The tile installation shall comply with the following order:

1. Installation of the Main Tiles
2. Installation of other accessories such as:
  - 2.1. Gable End Tiles & Gable End Tile Ends
  - 2.2. Ridge Tiles & Ridge related accessories such as Hip Starter, Ridge Tile End and 2-Way Tiles
4. 3-Way & 4-Way Apex Tiles.



## 4. Setting Out



It is important that the tiler should set out the roof prior to fixing. Setting out requires planning and measuring as well as to ensure that the rafters are properly positioned and spaced. This will help to save time and avoid unequal overhangs at verges and costs in cutting tiles at the abutments.



## 5. Battening and Eaves Fixing



Note: The below illustrations are based on the minimum Headlap / Head Overlap of 4 inches or 100mm and installation using conventional wooden battens and rafters. Should lightweight roofing structures are used, please refer to roof structure manufacturer for equivalent specifications.

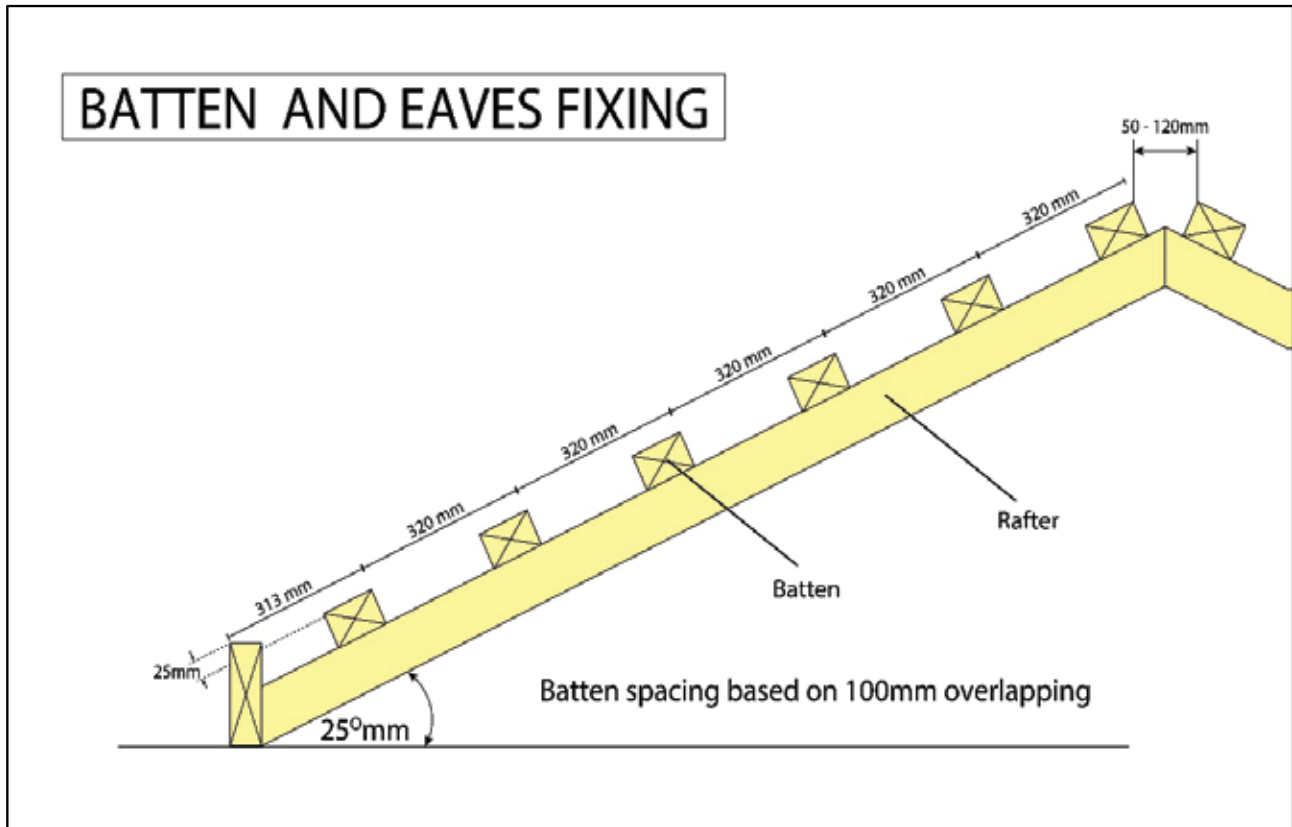

The recommended minimum Batten Size is 50mm x 25mm (2 inches x 1 inches) with up to 600mm (24 inches) Rafter centres. Batten Spacings of 320mm (12.6 inches) should be the maximum.

The type of wood used must be of good quality, straight and tandalised (kiln dried) to prevent premature roof sagging through age. Steel (hollow section) battens and Metal Trusses are increasingly used for its straightness which facilitates good tiles installation and prevents roof sagging. For safety and durability reasons, metal trusses and hollow sections of equivalent structural loading calculated from internationally approved engineering softwares can also be used.

The distance between two battens directly under the Ridge Tile shall be approximately 50mm – 120mm maximum (depending on desired headlap). The first batten nearest to the Ridge Tile is placed such as to ensure that the top course of the Lamano roof tiles would be aesthetically covered by the ridge tiles.

The last Batten at the Eave must be spaced up 25 mm higher than the previous batten (Fig. 5.1).

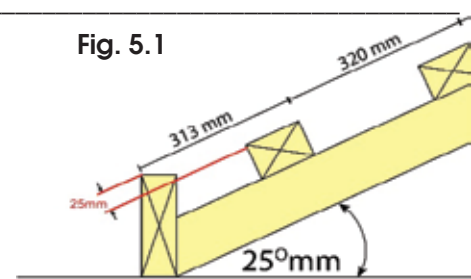

The spacing between the last Batten at the Eaves and the previous Batten is 313 mm.

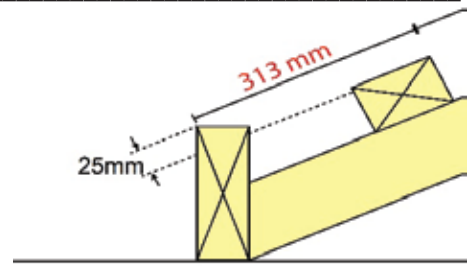

The last Batten at the Eave must be spaced up 25 mm higher than the previous batten (Fig. 5.1).

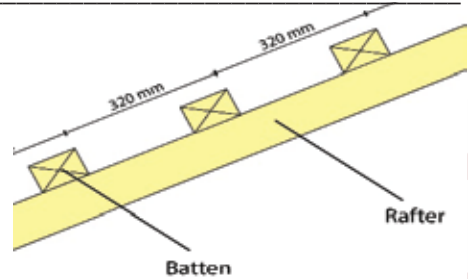

The last Batten at the Eave must be spaced up 25 mm higher than the previous batten (Fig. 5.1).

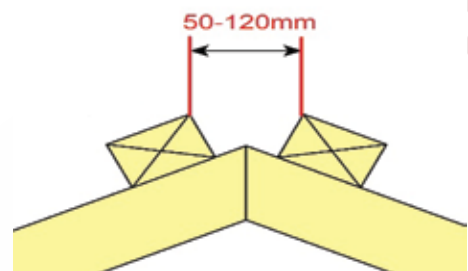

The last Batten at the Eave must be spaced up 25 mm higher than the previous batten (Fig. 5.1).



The last Batten at the Eave must be spaced up 25 mm higher than the previous batten (Fig. 5.1).



## 6. Roof Pitch and Head Lap

A minimum roof pitch of  $25^\circ$  is required for Lamano, however, Lama do not recommend to have the roof designed at minimum roof pitch. Lama recommends that roofs with rafter lengths in excess of 4.5 metres / 15 feet, be installed with an increased roof pitch of  $3^\circ$  for each additional 1 metre / 3 feet.





## 7. Installation of Lamano Roof Tiles



1) Lama LAMANO Roof Tiles recommended to lay in CROSS BOND/ STAGGERED LAYING METHOD only (Fig. 7.1).

Figure 7.1

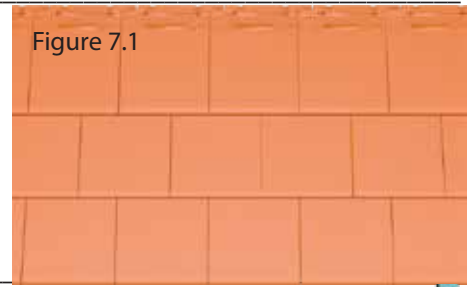

2) The tiles will have to be roofed respectively from the RIGHT to LEFT & BOTTOM to UP. Commencing from the bottom row first at the eaves, and at its farthest right (Fig. 7.2).

Figure 7.2

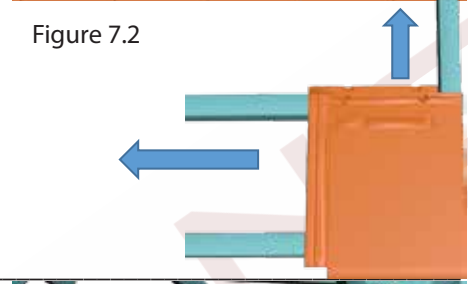

3) A Lamano Tile Starter Bracket is required for the first Lamano tile laid on every roof pane (Fig. 7.3).

If Gable End Tiles are to be installed, please ensure that the tile is installed approximately, 30mm distance from the outer Fascia Board.

Figure 7.3

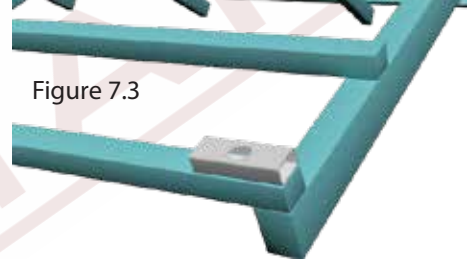

4) Lay the Lamano tile over the battens at their batten lugs, then laying the next tile along side so that it overlaps its neighbor. (Fig. 7.4). Complete laying the bottom row of the entire roof. Note that the end of each tile is to be raised by 25mm, as per Fig. 5.1 and Fig. 6.2 in Setting Out.

Figure 7.4

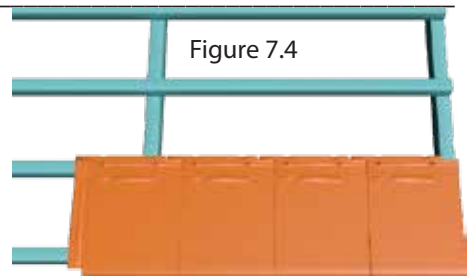

5) Using 38mm screws or equivalent Galvanised Steel Nails or Wire Nails, fasten/nail all tiles in the first row. (Fig. 7.5), (Ref: Part 8, Nailing or Screwing of Tiles – Pg. 22).

Figure 7.5

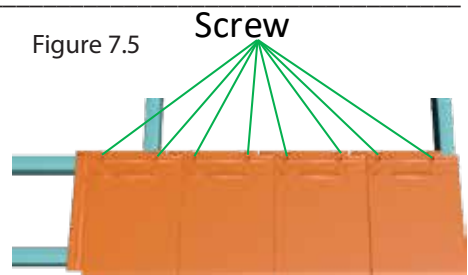

6) Second row laying start with a half tiles (150mm excluding underlock) (Fig. 7.6). Repeat this half tile laying as starter for alternate row.

Figure 7.6

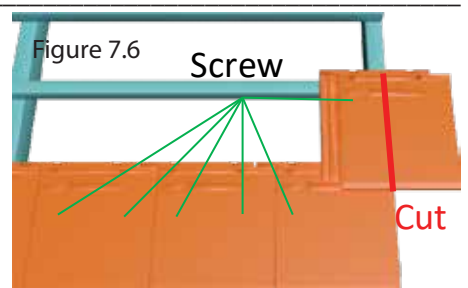

7) Laying RIGHT to LEFT & BOTTOM to UP as per mentioned in No. 1 above as Lamano Tiles have the underside of the overlap on the left (Fig. 7.7).

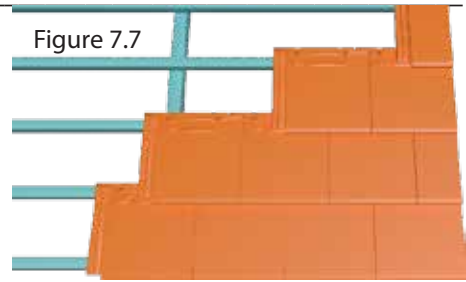

Figure 7.7

8) Tiles can be pre-placed on the roof with a crane for increased efficiency (Fig. 7.8).



Figure 7.8

9) Run a string from the peak of the roof at the ridge all the way down to the Fascia Board of the roof every 10-12 tiles to ensure that the tiles are laid straight (Fig. 7.9)..

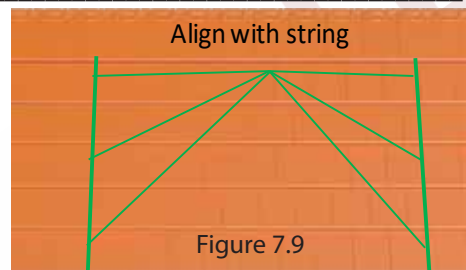

Align with string

Figure 7.9

Note: There should be a recommended shunt tolerance of 0.7mm-1.2mm Shunt clearance at the coverlock and underlock interlocking. Insufficient Shunt clearance (Shunt In of less than 0.7mm) will result in tile breakages at the cover locks when accidentally stepped upon.

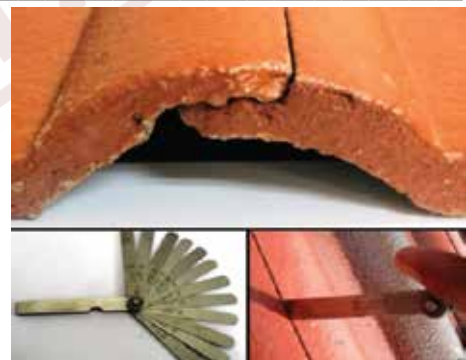



## 8. Screwing of Roof Tiles



Due to the possibility of wind uplift, Lamano Roof Tiles and Accessories laid on the roof may need to be fastened by either nails or screws. The extent and the method by which the tiles and accessories are to be fastened will depend on the location of the tile and accessories on the roof, the pitch of the roof, the span of the roof, the presence or absence of ceilings etc.

Tiles nailing or screwing is highly recommended to buildings in exposed surroundings frequented by strong gusts of wind, especially for buildings without a ceiling.

During nailing or screwing on the tile, it is important to ensure that there is no direct impact on the tile or too big a screw used as hairline fractures may appear on the tile and may cause future leakages.

Do not use nails or screws which are too large in diameter as it may easily fracture the nail holes and therefore the roof tile during installation.

The First / Lowest Row of the tiles and the Side / Outer Most Column of the tiles have the highest tendency to be blown off during extremely strong gusts of winds. Please ensure that ALL tiles mentioned here are nailed or screwed in when being applied to any buildings with the presence of strong winds regardless of roof pitch.

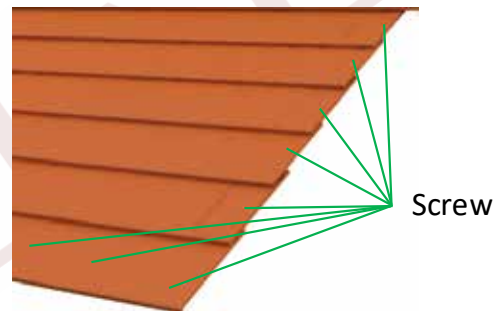

Do not overdrive the nails, there is not even any need for the nail head to come in contact with the tile - overdriving the nails risk damaging the tile (from the head of the hammer hitting the surface) - the tiles tend to be brittle and can easily be broken and may cause the nose of the tile to skew upwards thus causing breakages when being stepped on at the roof.

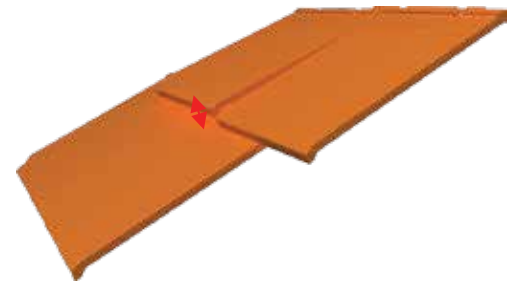

Lama recommends nailing or screwing pattern of the following for the Alternate Tile or Every Other Tile Securement: **Horizontal – 1 Tile in 4. Vertical – 1 Tile in 3.** The alternate nailing or screwing pattern should be an approximately 1 nail or screw per square metre.



## 9. Laying and Cutting of Lamano Tiles



Avoid cutting tiles whenever possible and never cut the bottom edge of the tile.

On short eaves, tiles may require cutting. Cut at tile verges should be at least half width of a full tile.

All vertical cuts should never be less than half a tile width.

On each span of the roof, tiles should be laid from the bottom up of the roof and from the right side in. Any tiles towards the wall or the hip (if any), will require cutting.

The use of a cutting tool with a diamond wheel cutting disk or any other disk which is specially designed for cutting masonry products, for the cutting separation of the tile is recommended.

Nails or Screws or cut tile clip should be used on all cut tiles

**Step 1** - Mark the Lamano tile along the line to be cut by scoring the tile with a marker (Fig. 9.1).



**Step 2** - Use a mechanical means (such as a disc cutter) for cutting concrete tiles, however, it can take a bit of practice to get a neat, clean cut using a disc cutter by freehand (Fig. 9.2).



**Step 3** - Place the roof tile onto the platform of the diamond blade cutter. Align the blade edge with the scored line of the concrete roof tile. Slowly run the blade of the saw over the tile, following the rail on the saw table to guide the blade.

**Step 4** - Run the blade over the surface of the tile, cutting it in several passes / repeated times to prevent breakage.



# 10. LAMANO Tile Accessories



**Lamano Ridge**  
Internal Angle 110 degree  
Coverage 2.7 pcs / meter run  
Approximate Weight 4 kg

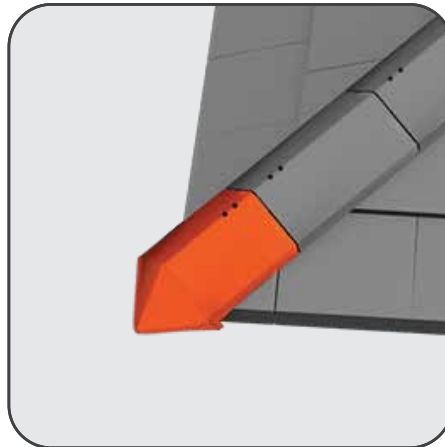

**Lamano Hip Starter**  
Approximate Weight 3.5 kg

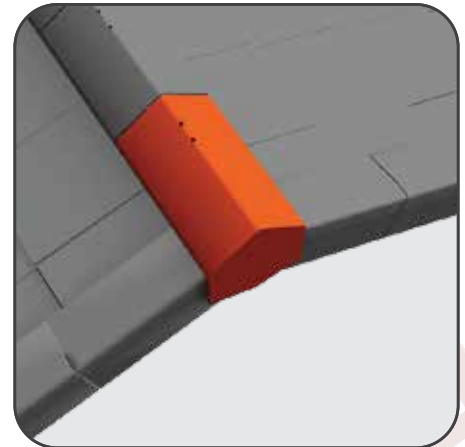

**Lamano Ridge Tile End**  
Approximate Weight 5 kg

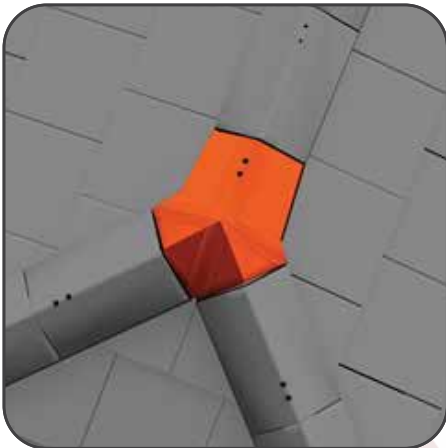

**Lamano 3-Way**  
Approximate Weight 5 kg  
Pitch Angle  
Fitment to pitches up To

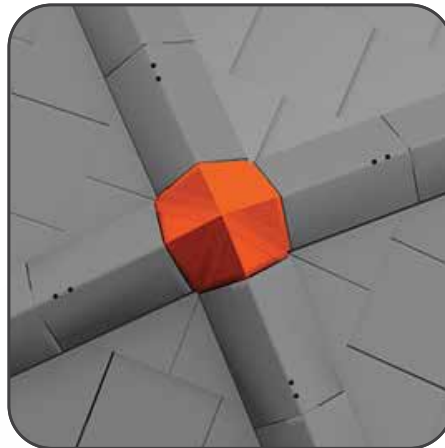

**Lamano 4-Way**  
Approximate Weight 4 kg  
Pitch Angle  
Fitment to pitches up To

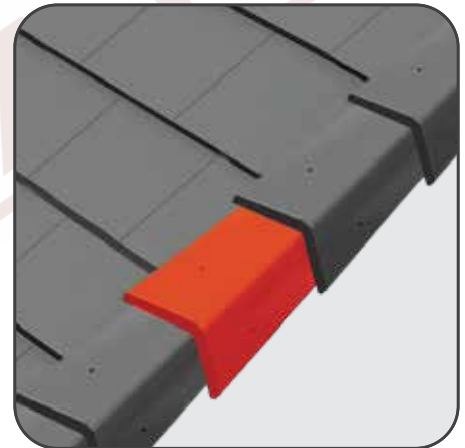

**Lamano Gable End**  
Approximate Weight  
Internal Angle  
Coverage 1 piece / main tile length

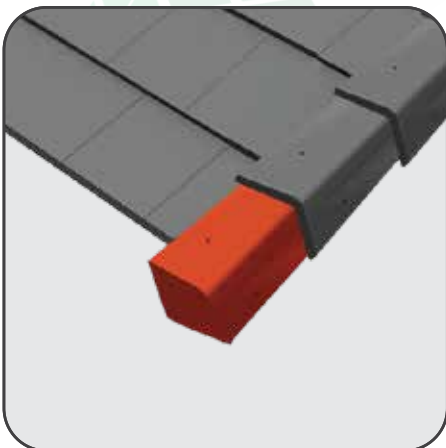

**Lamano Gable End Tile End**  
Approximate Weight



**ROMAN RADIANT BARRIERS  
ROOFING FOILS**  
Single Sided: 80 GSM @ 100 Microns, ± 10%  
Double Sided: 100 GSM @ 120 Microns, ± 10%  
Reflectivity: 95%  
Coverage: 1.22 metres width X 50 metres length



Required for the first Lamano tile laid on every roof pane.

**Lamano Tile Starter Bracket**



## 11. Installation of Verges and Gable End Tile

### PRIOR TO INSTALLING THE GABLE END TILES

Fasten every verge roof tile regardless if it is a full or cut tile. Screws are however, preferred over nails. Specialised clips may be used.

Interlocks of tiles can be removed to facilitate the fixing of external verge clips.

Verge roof tiles at the eaves should over hang by same amount as the rest of the tiling.

Cutting of tiles should be minimized by properly setting out prior. If the overhang section of the roof is too much and has to be cut, ensure that they are symmetrical at both verges. The cut verge roof tile should not exceed the outer edge of the fascia board.

### GABLE END TILE INSTALLATION

1) Each Lamano Gable End tile is designed to cover 1 length of main tiles and starts off with the Gable End "TILE END", which starts on the roof eaves of the verge.

2) Screws are preferred over nails for the installation of the Gable End tiles as the torque can be controlled with multiple tile adjustments without damaging the fascia board.

Preparation for Gable End Tile End

3) Measure the distance from the bottom of the first row eaves tile to the bottom of the second tile (Fig. 11.2).

4) Mark the length of the Gable End "Tile End". Cut off the excess of the Gable End "Tile End" at the smaller tapered end, to fit onto the first row of tile in (Fig. 11.3).

5) Align the wider tapered end of Lamano Gable End tile in line with bottom edge of LAMANO roof tile (Fig. 11.4).

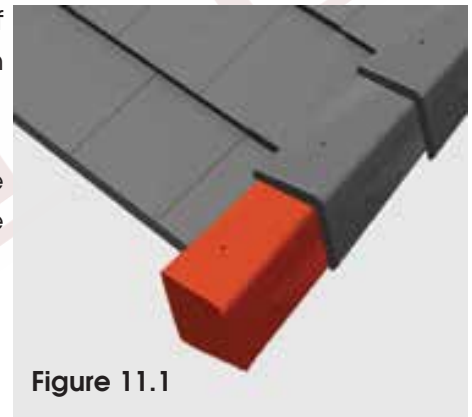

Figure 11.1

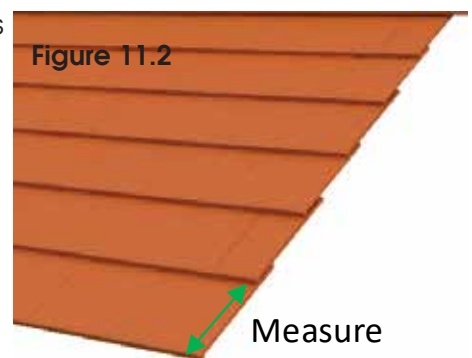

Figure 11.2



Figure 11.3

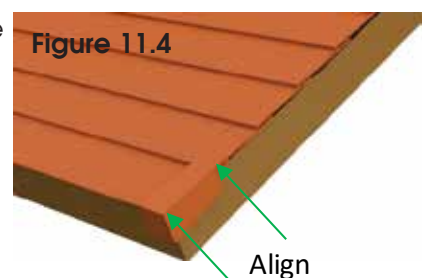
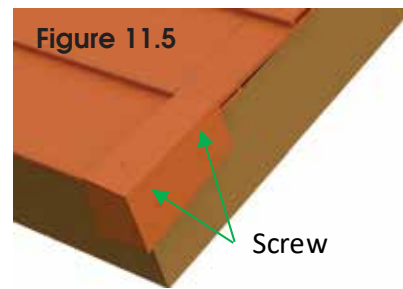
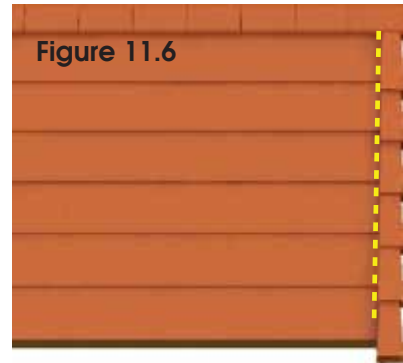

Figure 11.4

6) Install the Gable End "Tile End" first with fasteners. Screws are however, preferred over nails (Fig. 11.5).



7) Pull a string from the last ridge of the roof closest to the verge, and ensure that the Gable End Tiles are aligned properly and consistently (Fig. 11.6).



8) Ensure that each of the following Gable End tiles are wrapped around the verge and should be touching both the outer edge of the fascia board as well as the roof tile. Each of the larger taper openings of the Gable End overlaps the smaller taper ends (Fig. 11.7).



9) All LAMANO Gable End Tiles must be secured using screws on to the fascia board through the pre-punched hole markings provided. These nail hole markings are intentionally made not through, therefore, drilling the hole through will be required prior to fixing (Fig. 11.8).

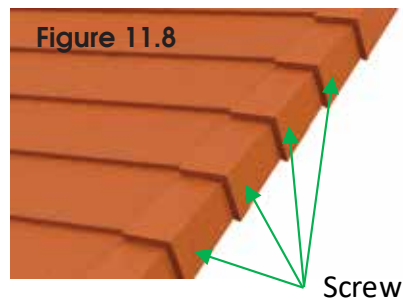

10) For Gable roofs, the last Gable End tiles from both verges should be spaced out as close as possible so that the intersection of the two edges are almost touching each other (Fig. 11.9).

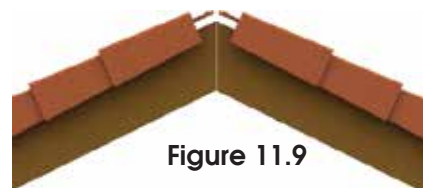



## 12. Installation of Ridge Tile End



For roofs with Gables installed with Gable End tiles, 2 section should be cut at the sides of the Ridge Tile End. The amount and shape or area to be cut will depend on the pitch of the roof

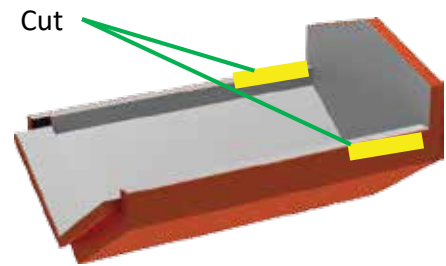

## 13. Ridge & Hip Preparation and Installation

### INSTALLATION OF DRY RIDGE AND HIP

At the ridge intersection of 2 verges (i.e. hip), use the tile cutter to cut the tiles along the ridge with minimal gaps while ensuring that all the tiles are in place. Tiles should be cut in a straight line,

keeping the cut centered on the hip board. Should the tiles be moveable, secure them with fastening, cut tile clips or adhesive (Fig. 20.1).

The ridge and hips are finished with ridge tiles. Where ridges meet (such as where a hip ridge meets a main ridge), the ridge tiles should be trimmed so that the ends of the ridge tiles are parallel when fitted (Fig. 20.2).

Extend a string from one end of the ridge verge to the other if it is a gable roof or from the hip starter to the roof apex (string to be remove after installation). Proceed to lay the rest of the ridges or hip ridge using the centre of the ridge as a reference to the extended string (Fig. 20.4).

It is highly recommended to fix every ridge tile to the ridge runner with screw.



## 14. Installation of Hip Starter



The hip starter is the first to be installed at the hip and must be attached properly (Fig. 14.1)

Install the next hip ridge after the hip starter. Making sure that the mid-points of the ridge meets up in a straight line (Fig. 21.2).

Extend a string from one end of the hip starter to the roof apex. Proceed to lay the rest of the hip ridge using the centre of the ridge as a reference to the extended string (Fig. 21.2).

It is highly recommended to fasten or fix it to ridge runner using screw (Fig.21.3).

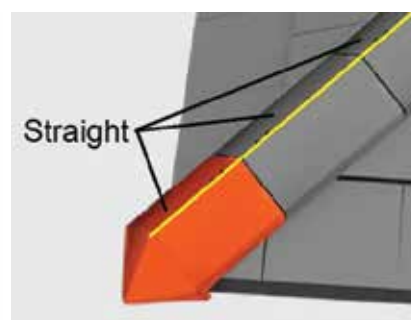





## 15. Installation of 2-way tiles

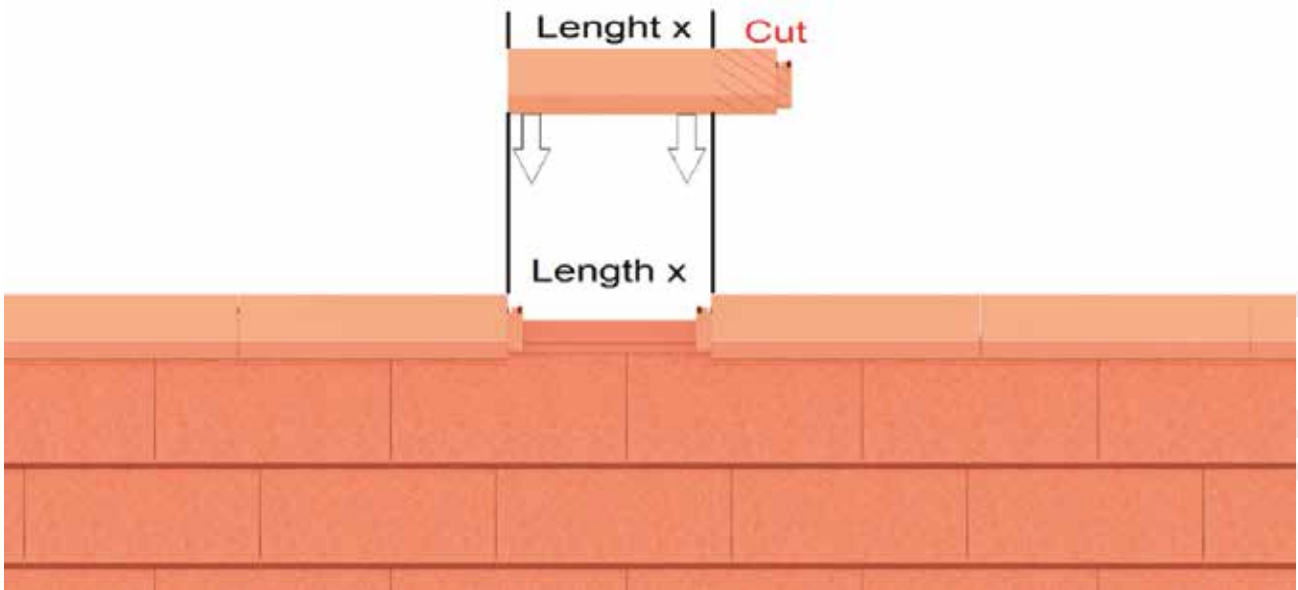

Step 1: A 2-Way tile is mostly used on a Gable roof whereby both ends of the roof are the verges, therefore, necessitating the use of two Tile Ends. In order to facilitate two tile ends, one part of the ridge will face a back to back situation whereby a 2-Way tile is required.

Step 2: Measure the length between the 2 back to back facing ridge tiles (exclude the underlock).

Step 3: Mark and trim a Lamano ridge tile to become a 2 way tile.

Step 4: Install the 2-Way tile into the mid-point of the ridge.



## 16. Installation of 3-way & 4-way apex tile

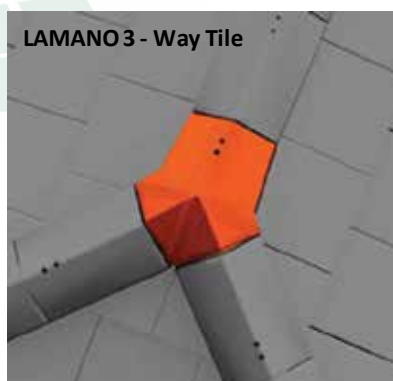

The Lamano 3-WAY and 4-WAY Apex tile is used in conjunction at the very peak of a 3 or 4 pane Hip roof.

Place the 3- WAY or 4- Way apex tile over the Lamano ridge tile. It is highly recommended to secure it with screw.



## 17. Installation of Valley Gutters

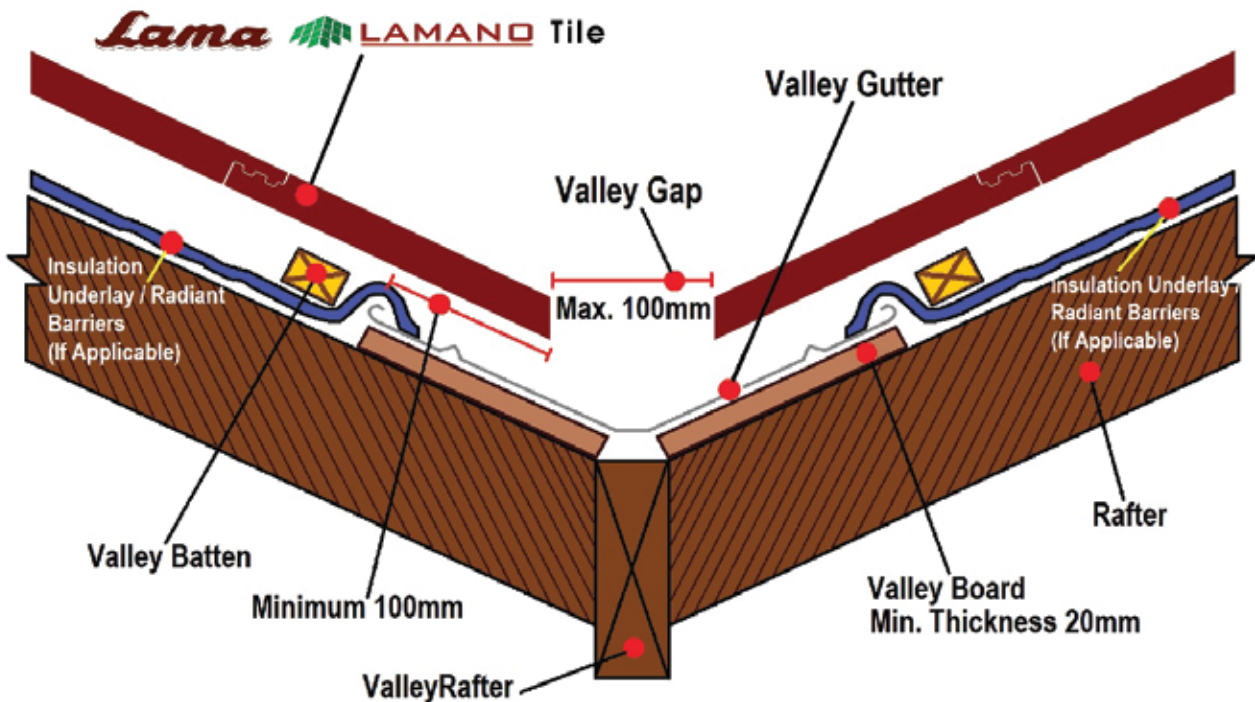

There are many different designs of valley gutters available in varying sizes (Fig. 17.2). Valley gutters are available in a variety of materials. The construction and design of the valley should follow the instructions of the valley gutter manufacturer whereby the flow of water should be as smooth as possible with minimal or no obstruction. Leakages leading to damages may occur should there be any overflow or backflow of rainwater. The eaves of the tiles should be cut in a straight line and must overlap the valley gutter by a minimum of 100mm (Fig. 17.1).

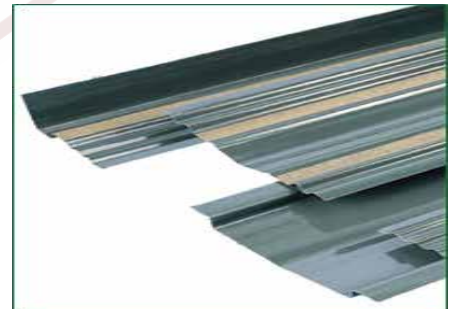

The valley gap / open channel is the gap between the cut tiles at the valley should be approximately 76mm or 3 inches but must not be more than 100mm / 4 inches (Fig. 17.1).

The gutter must be of smooth surface and must be supported along its entire length by the valley board, at least 20mm in thickness (Fig. 17.1).



The valley battens should be mitre cut and skew nailed to the edge of the valley boards with the valley boards which are mounted to the counter battens leveled at the top surface. Valley batten spacings should be made to suit the valley gutter manufacturer's specifications. In any event, the valley gutters must not obstruct the interlocking of the roof tiles. Should the batten lugs of the tiles be in the way of the valley gutter, the batten lugs shall be removed by knocking with a hammer.



The lower the roof pitch or the longer the valley, the wider or larger rain water flow capacity is required of a gutter. Most gutters with width of 125mm / 5 inches, is sufficient, however, for pitches below 35 degrees gradient or valley lengths of more than 5 metres / 16 feet, a wider gutter may be required. Valley gutters longer than 6 metres / 20 feet is not recommended.



Where Two Valleys Are To Join Into One, The Joining Must Be Correctly Done With Proper Sealing To Avoid Leakages (Fig. 17.3).

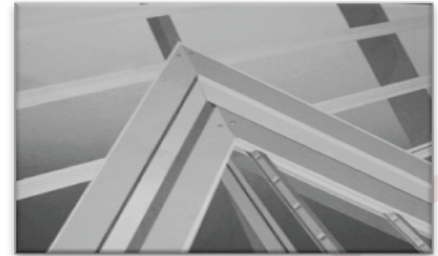

All tiles either side of the valley must be mechanically fixed by either screwing or nailing the tiles to the battens. If the tile nail hole is no longer present, they will have to be secured using specialized clip brackets or anchor hooks and even wire ties as a last resort. There should be no tiles missing from the valley sections (Fig. 17.4).



LAMM



## 18. Walking on Roof



The weight of a person standing on the roof as well as the weight of the tile itself is supported by the battens of the roof just beneath the suggested stepping point. This point is where the load is distributed to near the bearing points of the tile. Stepping on other points may result in the tile breaking, cracking or developing a hairline fracture which may cause leakages further down the line.

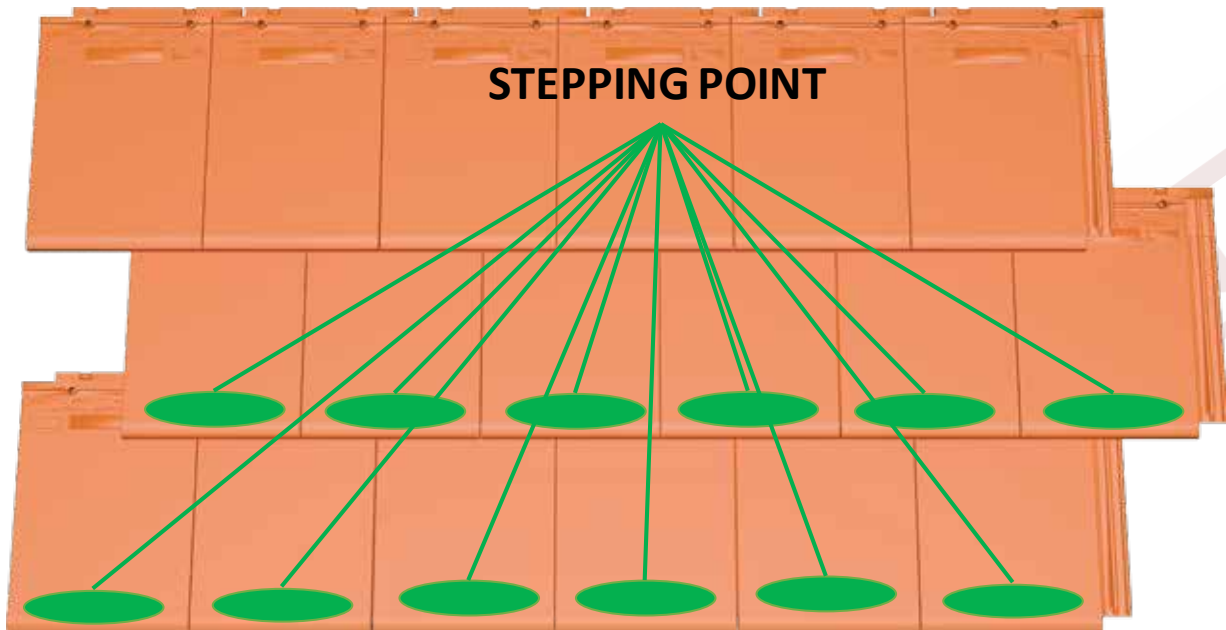

The weight of a person standing on the roof as well as the weight of the tile itself is supported by the battens of the roof just beneath the suggested stepping point. This point is where the load is distributed to near the bearing points of the tile. Stepping on other points may result in the tile breaking, cracking or developing a hairline fracture which may cause leakages further down the line.

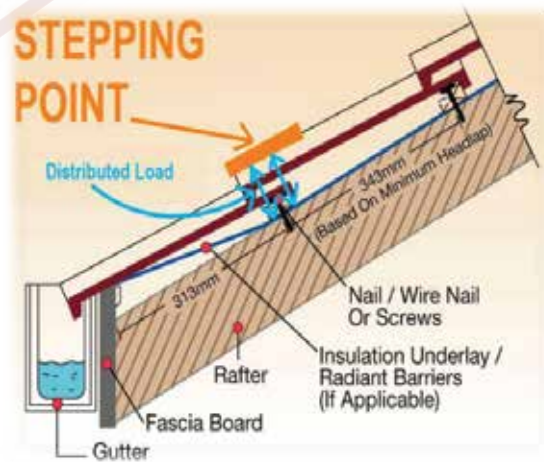

## 19. Weather Effects of Roof Tiles



Constant exposure to Ultra Violet rays from the sun, acidity of rain as well as other nature's elements causing oxidation may lighten the tile colours slightly. Through time of a few years, the gloss polymer coating applied to new tiles will eventually take on a matt appearance. The product functions however, will not be affected



## 20. Repairing & Replacement of Broken Tiles

Individual tiles or accessories that are damaged during or after installation should be replaced as soon as possible using matching units fixed in accordance with the screwing or nailing and/or clipping specification. Superficial coatings or repairs to damaged units using adhesives or other mechanical devices should not be used as their long term performance may be limited. If extensive repairs to the roof is required, sectional or complete re-tiling of that section should be considered as this may be the most practical and economic solution.



## 21. Transfer, Stacking & Storage Of Roof Tiles At Site

Caution and care against tile scratches and breakages should be taken during the transferring of tiles to the ground and/or to the roof while ensuring safety.



Ensure that each of the following Gable End tiles are wrapped around the verge and should be touching both the outer edge of the fascia board as well as the roof tile. Each of the larger taper openings of the Gable End overlaps the smaller taper ends (Fig. 35.11), (ref: Installation of Verges & Gable End Tile, Part 18 – Pg.35).



