

MAF302 series

AIR UNIT (FILTER / WATER SEPARATOR)



mindman



Symbol

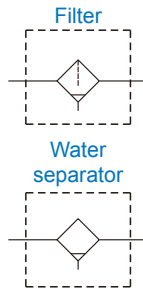

Specification

Model	MAF302		
Bore No.	8A	10A	15A
Port size	1/4	3/8	1/2
Medium	Air		
Operating pressure range (*1)	0.05~1 MPa		
Proof pressure	1.5 MPa		
Ambient temperature	- 5~+60°C (No freezing)		
Drain capacity	35 cm ³		
Filter	MAF302		
Filter element	Standard: 5μm, Option: 40μm		
Weight	335 g		
Water separator	MAF302G		
Water droplet removal ratio (*2)	99±1%		
Rated flow l/min(ANR) (*3)	550	1280	
Weight	345 g		

Order example

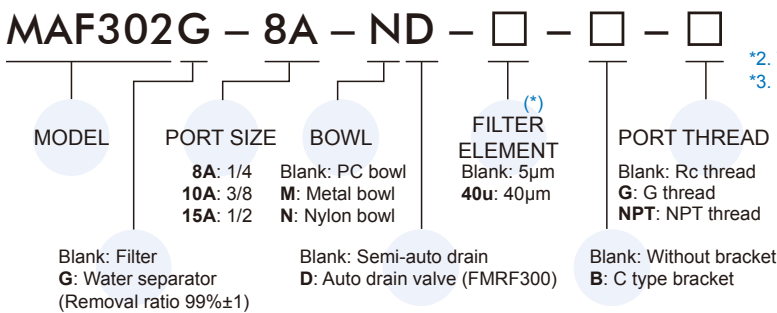

* There is not filter element in MAF302G series.

- *1. Standard unit contains semi-auto-drain function when operating pressure below 0.05 MPa. Choose auto-drain FMRF300, the pressure range is 0.15~1 MPa.
- *2. This shows the water droplet removal ratio at the rated flow.
- *3. Input pressure: 0.7 MPa. When fluid flows exceeding the rated flow, the accumulated condensate may be pulled up and may flow out to outlet side.

Water separator features

- Water droplets are removed by centrifugal force. This product can remove water droplets in the compressed air, but cannot remove moisture content (water vapor).
- Filter element is not needed. Water droplet removal ratio: 99%

Flow feature

MAF302 (Filter)

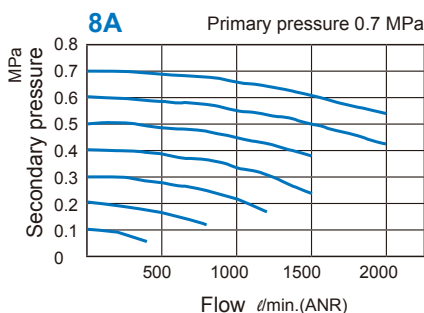

MAF302G (Water separator)

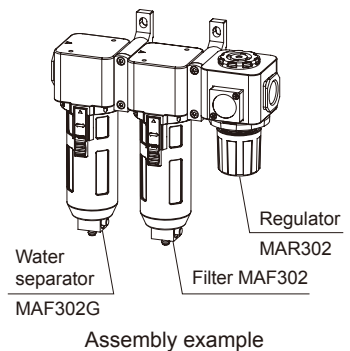
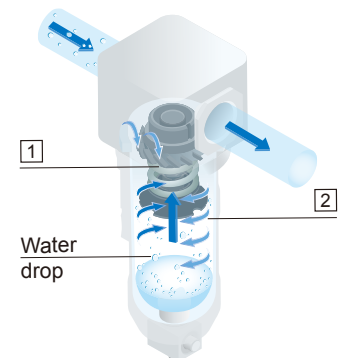
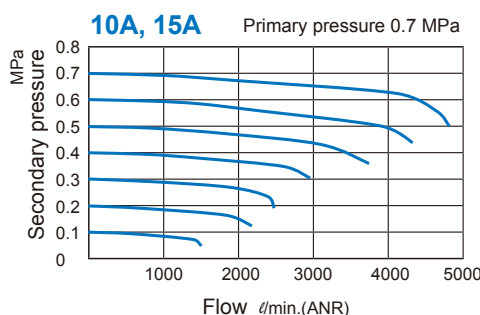
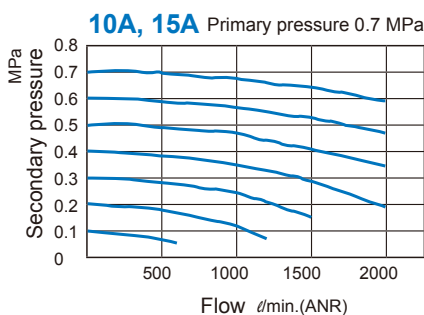
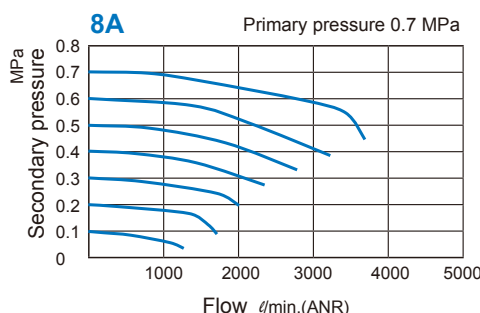

MAF302 Dimensions

AIR UNIT (FILTER / WATER SEPARATOR)

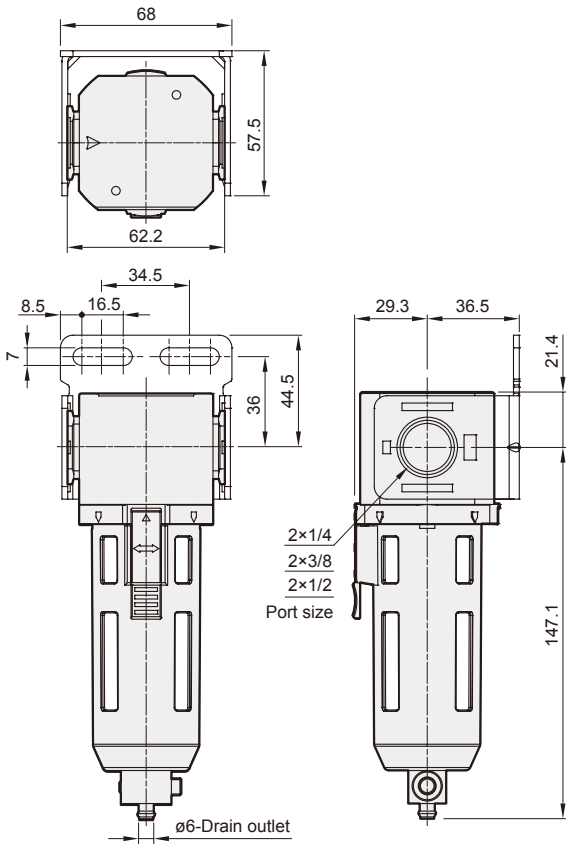

Option accessories

C type bracket

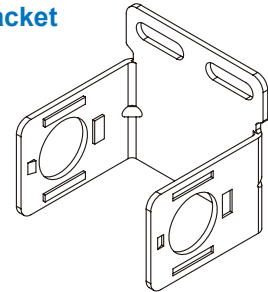

! Caution

Metal bowl

Before assembling or disassembling, push the lock plate down to the end, and confirm that it is detached from the body then rotate the bowl, otherwise the lock plate will be deformed or the body will be scratched.

1. Sliding plate down

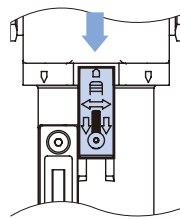

2. Rotating the bowl

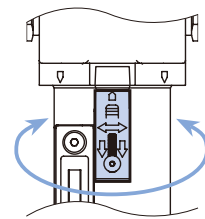

MAF302-D

Auto drain valve

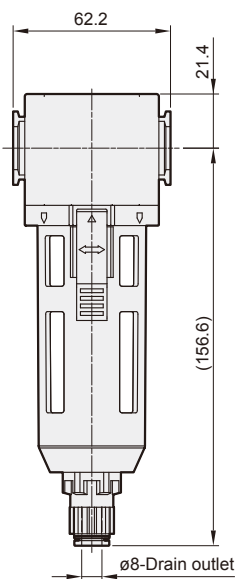

MAF302-M

Metal bowl

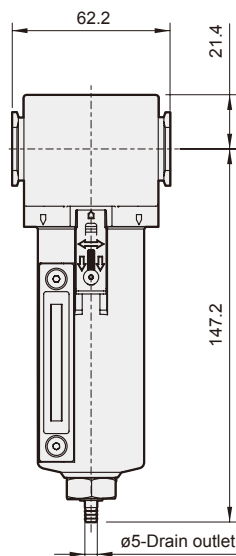

MAF302-MD

Metal bowl + Auto drain valve

