

Ultra High Purity

TUBE & PIPE BEND FITTINGS



Tube & Pipe Bend Fittings

Ordering Information

*Additional configurations available upon request.

A	B	C	-	D	Standard feature
SM	50A	EL	-	P	Optional

A Materials	
SM	316L Stainless Steel
DM	316L Stainless Steel VAR
4SS	304 Stainless Steel

B Connection Size				
ASTM Tube				
Designator	Nominal Size	Outside Diameter	Wall Thickness	
4	1/4 in.	6.35 mm	1.00 mm	
4S			0.89 mm	
6	3/8 in.	9.53 mm	1.00 mm	
6S			0.89 mm	
8	1/2 in.	12.7 mm	1.24 mm	
8S			1.00 mm	
12	3/4 in.	19.05 mm	1.65 mm	
12S			1.24 mm	
16	1 in.	25.4 mm	1.65 mm	
16S			1.24 mm	
20	1-1/4 in.	31.8 mm	1.65 mm	
24	1-1/2 in.	38.1 mm	1.65 mm	
32	2 in.	50.8 mm	1.65 mm	
40	2-1/2 in.	63.5 mm	1.65 mm	
48	3 in.	76.2 mm	1.65 mm	
64	4 in.	101.6 mm	2.11 mm	
80	5 in.	127 mm	2.77 mm	
80S			3.05 mm	
96	6 in.	152.4 mm	2.77 mm	
96S			3.05 mm	
JIS Pipe				
Designator	Nominal Size	Outside Diameter	Schedule	Wall Thickness
8A	8A	13.8 mm	SCH 5S	1.20 mm
8AS			SCH 10S	1.65 mm
10A	10A	17.3 mm	SCH 5S	1.20 mm
10AS			SCH 10S	1.65 mm
15A	15A	21.7 mm	SCH 5S	1.65 mm
15AS			SCH 10S	2.10 mm
20A	20A	27.2 mm	SCH 5S	1.65 mm
20AS			SCH 10S	2.80 mm

B Connection Size (Continued)				
JIS Pipe				
Designator	Nominal Size	Outside Diameter	Schedule	Wall Thickness
25A	25A	34.0 mm	SCH 5S	1.65 mm
25AS			SCH 10S	2.80 mm
32A	32A	42.7 mm	SCH 5S	1.65 mm
32AS			SCH 10S	2.80 mm
40A	40A	48.6 mm	SCH 5S	1.65 mm
40AS			SCH 10S	2.80 mm
50A	50A	60.5 mm	SCH 5S	1.65 mm
50AS			SCH 10S	2.80 mm
65A	65A	76.3 mm	SCH 5S	2.10 mm
65AS			SCH 10S	3.00 mm
80A	80A	89.1 mm	SCH 5S	2.10 mm
80AS			SCH 10S	3.00 mm
100A	100A	114.3 mm	SCH 5S	2.10 mm
100AS			SCH 10S	3.00 mm
125A	125A	139.8 mm	SCH 5S	2.80 mm
125AS			SCH 10S	3.40 mm
150A	150A	165.2 mm	SCH 5S	2.80 mm
150AS			SCH 10S	3.40 mm
200A	200A	216.3 mm	SCH 5S	2.80 mm
200AS			SCH 10S	4.00 mm
250A	250A	267.4 mm	SCH 5S	3.40 mm
250AS			SCH 10S	4.00 mm
300A	300A	318.5 mm	SCH 5S	4.00 mm
300AS			SCH 10S	4.50 mm
350A	350A	355.6 mm	SCH 5S	4.00 mm
350AS			SCH 10S	4.80 mm
400A	400A	406.4 mm	SCH 5S	4.20 mm
400AS			SCH 10S	4.80 mm
450A	450A	457.2 mm	SCH 5S	4.20 mm
450AS			SCH 10S	5.50 mm
500A	500A	508.0 mm	SCH 5S	4.80 mm
500AS			SCH 10S	5.50 mm
550A	550A	558.8 mm	SCH 5S	4.80 mm
550AS			SCH 10S	5.50 mm

Optional End Connection Sizes

For drop size fittings, first size the run and add the suffix "X" then a size designator for the branch. (i.e. Reducing Tee for 25A pipe connection for the main run and 1 inch tube connection for the branch would be 25AX16)







Tube & Pipe Bend Fittings







C	Body Type	
EL	90° Long Elbow	
ES	90° Short Elbow	
ELH	45° Long Elbow	
TL	Standard Tee	
TS	Standard Short Tee	
RTL	Reducing Tee	
RC	Concentric Reducer	
REB	Eccentric Reducer	
CPB	Cap	
CPR	Cap Reducer	
JTM	Joint Tee (Male)	
JTF	Joint Tee (Female)	
JRM	Joint Reducer (Male)	
JRF	Joint Reducer (Female)	
JCPM	Joint Cap (Male)	
JCPF	Joint Cap (Female)	
GTT	Teflon Gasket	
FLJ	Lap Joint Flange	
FRF	RF Flange	
FB	Blind Flange	
LJ	Lap Joint	
TMH	Multi-Header Tee	
TMHJ	Multi-Header Joint Tee	

D	Wetted Surface Grade	
	BA is standard. No part designator needed.	
P	EP	
MP	MP	
AP	AP	

Body Type

	90° Long Elbow
	90° Short Elbow
	45° Long Elbow
	Standard Tee
	Standard Short Tee
	Reducing Tee
	Concentric Reducer
	Eccentric Reducer

	Cap
	Cap Reducer
	Joint Tee (Male)
	Joint Tee (Female)
	Joint Reducer (Male)
	Joint Reducer (Female)
	Joint Cap (Male)
	Joint Cap (Female)

	Teflon Gasket
	Lap Joint Flange
	RF Flange
	Blind Flange
	Lap Joint
	Multi-Header Tee
	Multi-Header Joint Tee

Part Number Examples

	SM50ASEL-P		DM16SEL	
Material	SM	316L Stainless Steel	DM	316L Stainless Steel VAR
Connection Size	50AS	SCH10S. 50A JIS Pipe	16S	1 in. Special Tube
Body Type	EL	90° Long Elbow	EL	90° Long Elbow
Surface Grade	P	EP Grade		BA Grade (standard)

	4SS12ES-AP		SM12SES-P	
Material	4SS	304 Stainless Steel	SM	316L Stainless Steel
Connection Size	12	3/4 in. Tube	12S	3/4 in. Special Tube
Body Type	ES	90° Short Elbow	ES	90° Short Elbow
Surface Grade	AP	AP Grade	P	EP Grade

	DM16X12CPR-P		SM50AX16CPR	
Material	DM	316L Stainless Steel VAR	SM	316L Stainless Steel
Connection Size	16X12	1 in. Tube (Run) X 3/4 in. Tube (Branch)	50AX16	SCH5S. 50A JIS Pipe (Run) X 1 in. Tube (Branch)
Body Type	CPR	Cap Reducer	CPR	Cap Reducer
Surface Grade	P	EP Grade		BA Grade (standard)

	SM50AX20ARTL		DM25AX16RTL-P	
Material	SM	316L Stainless Steel	DM	316L Stainless Steel VAR
Connection Size	50AX20A	SCH5S. 50A Pipe JIS (Run) X SCH5S. 25A Pipe (Branch)	25AX16	SCH5S. 25A JIS Pipe (Run) X 1 in. Tube (Branch)
Body Type	RTL	Reducing Tee	RTL	Reducing Tee
Surface Grade		BA Grade (standard)	P	EP Grade

	4SS50AX4TMH-MP		DM32X8TMH	
Material	4SS	304 Stainless Steel	DM	316L Stainless Steel VAR
Connection Size	50AX4	SCH5S. 50A JIS Pipe (Run) X 1/4 in. Tube (Branch)	32X8	2 in. Tube (Run) X 1/2 in. Tube (Branch)
Body Type	TMH	Multi-Header Tee	TMH	Multi-Header Tee
Surface Grade	MP	MP Grade		BA Grade (standard)

EL 90° Long Elbow

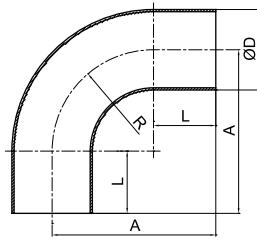

AUTO WELDING 90° ELBOW
(8A~100A) (1/4"~6")

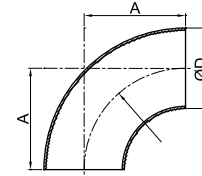

MANUAL WELDING 90° ELBOW
(125A ~ 300A)

JIS PIPE (A Size)

D	8A	10A	15A	20A	25A	32A	40A	50A	65A	80A	100A	125A	150A	200A	250A	300A
R	25.4	25.4	38.1	38.1	38.1	47.6	57.2	76.2	63.5	76.2	101.6	190.5	228.6	304.8	381.0	457.2
A	55.0	62.0	75.0	75.0	75.0	94.0	104.0	123.0	115.0	128.0	153.0	190.5	228.6	304.8	381.0	457.2
L	29.0	36.0	36.0	36.0	36.0	46.0	46.0	46.0	51.0	51.0	51.0	-	-	-	-	-

ASTM TUBE (Inch Size)

D	1/4"	3/8"	1/2"	5/8"	3/4"	1"	1-1/4"	1-1/2"	2"	2-1/2"	3"	4"	5"	6"
R	20.0	23.0	25.0	28.0	30.0	33.0	47.6	57.2	76.2	95.3	95.3	133.4	190.5	228.6
A	49.0	52.0	54.0	65.0	66.0	69.0	84.0	104.0	123.0	147.0	147.0	185.0	250.0	290.0
L	29.0	29.0	29.0	36.0	36.0	36.0	36.0	46.0	46.0	51.0	51.0	51.0	56.0	56.0

ES 90° Short Elbow

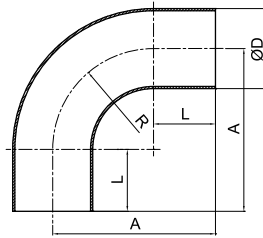
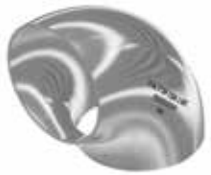

AUTO WELDING 90° ELBOW
(8A~100A)

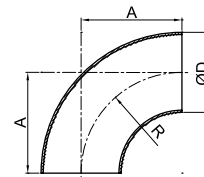

MANUAL WELDING 90° ELBOW
(125A ~ 300A)

JIS PIPE (A Size)

D	8A	10A	15A	20A	25A	32A	40A	50A	65A	80A	100A	125A	150A	200A	250A	300A
R	12.7	12.7	12.7	19.1	25.4	31.8	38.1	50.8	63.5	76.2	101.6	127.0	152.4	203.2	254.0	304.8
A	42.0	49.0	49.0	56.0	62.0	78.0	85.0	97.0	115.0	128.0	153.0	127.0	152.4	203.2	254.0	304.8
L	29.0	29.0	29.0	36.0	36.0	36.0	36.0	46.0	46.8	51.0	51.0	-	-	-	-	-

NOTE:

·Dimensions and Drawings are for reference only and are subject to change without prior notice.
·Unless otherwise specified, all dimensions are in millimeters.

ELH 45° Long Elbow

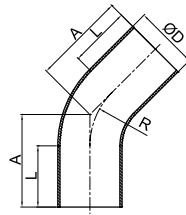

AUTO WELDING 45° ELBOW
(8A~100A) (1/4"~6")

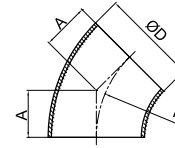

MANUAL WELDING 45° ELBOW
(125A ~ 300A)

JIS PIPE (A Size)

D	8A	10A	15A	20A	25A	32A	40A	50A	65A	80A	100A	125A	150A	200A	250A	300A
R	25.4	25.4	38.1	38.1	38.1	47.6	57.2	76.2	95.3	114.3	152.4	190.5	228.6	304.8	381.0	457.2
A	40.0	47.0	52.0	52.0	52.0	66.0	70.0	78.0	91.0	99.0	115.0	78.9	94.7	126.2	157.8	189.4
L	29.0	36.0	36.0	36.0	36.0	46.0	46.0	46.0	51.0	51.0	51.0	-	-	-	-	-

ASTM TUBE (Inch Size)

D	1/4"	3/8"	1/2"	5/8"	3/4"	1"	1-1/4"	1-1/2"	2"	2-1/2"	3"	4"	5"	6"
R	20.0	23.0	25.0	28.0	30.0	33.0	47.6	57.2	76.2	95.3	95.3	133.4	190.5	228.6
A	38.0	39.0	40.0	48.0	49.0	50.0	56.0	70.0	78.0	91.0	91.0	107.0	140.0	155.0
L	29.0	29.0	29.0	36.0	36.0	36.0	36.0	46.0	46.0	51.0	51.0	51.0	56.0	56.0

TL Standard Tee

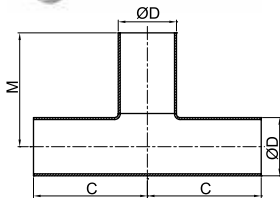

JIS PIPE (A Size)

D	8A	10A	15A	20A	25A	32A	40A	50A	65A	80A	100A	125A	150A	200A	250A	300A
C	42	49	59	65	68	88	95	102	121	130	145	123.8	142.9	177.8	215.9	254.0
M	42	49	59	65	68	88	95	102	121	130	145	123.8	142.9	177.8	215.9	254.0

ASTM TUBE (Inch Size)

D	1/4"	3/8"	1/2"	5/8"	3/4"	1"	1-1/4"	1-1/2"	2"	2-1/2"	3"	4"	5"	6"
C	35	37	39	49	52	55	59	74	77	90	97	110	140	160
M	35	37	39	49	52	55	59	74	77	90	97	110	140	160

TS Standard Short Tee

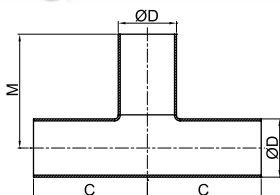

JIS PIPE (A Size)

D	15A	20A	25A	32A	40A	50A	65A	80A	100A
C	52	55	59	74	77	83	97	103	116
M	52	55	59	74	77	83	97	103	116

NOTE:
·Dimensions and Drawings are for reference only and are subject to change without prior notice.
·Unless otherwise specified, all dimensions are in millimeters.

RTL Reducing Tee

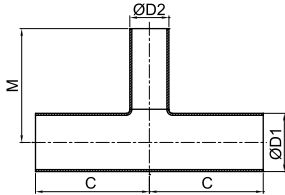

JIS PIPE (A Size)

D1	D2	C	M	D1	D2	C	M
8A	1/2", 3/8", 1/4"	42	42	125A	8A, 1/2", 3/8", 1/4"	80	110
10A	8A, 1/2", 3/8", 1/4"	47	44		25A, 20A, 15A, 10A, 1-1/4", 1", 3/4", 5/8"	100	120
15A	8A, 1/2", 3/8", 1/4"	47	44		50A, 40A, 32A, 2", 1-1/2"	120	130
	10A, 3/4", 5/8"	52	52		100A, 80A, 65A, 4", 3", 2-1/2"	140	140
20A	8A, 1/2", 3/8", 1/4"	47	47	150A	5"	160	160
	15A, 10A, 1", 3/4", 5/8"	55	55		8A, 1/2", 3/8", 1/4"	90	130
25A	8A, 1/2", 3/8", 1/4"	47	50		25A, 20A, 15A, 10A, 1-1/4", 1", 3/4", 5/8"	110	140
	20A, 15A, 10A, 1-1/4", 1", 3/4", 5/8"	59	59		50A, 40A, 32A, 2", 1-1/2"	130	150
32A	8A, 1/2", 3/8", 1/4"	57	54	200A	100A, 80A, 65A, 4", 3", 2-1/2"	150	160
	25A, 20A, 15A, 10A, 1-1/4", 1", 3/4", 5/8"	68	62		125A	170	170
40A	8A, 1/2", 3/8", 1/4"	57	57		8A, 1/2", 3/8", 1/4"	100	150
	25A, 20A, 15A, 10A, 1-1/4", 1", 3/4", 5/8"	68	65		25A, 20A, 15A, 10A, 1-1/4", 1", 3/4", 5/8"	120	160
50A	32A, 1-1/2"	77	77	50A, 40A, 32A, 2", 1-1/2"	140	170	
	8A, 1/2", 3/8", 1/4"	57	63	100A, 80A, 65A, 4", 3", 2-1/2"	160	180	
	25A, 20A, 15A, 10A, 1-1/4", 1", 3/4", 5/8"	68	71	150A, 125A, 6" 5"	180	190	
65A	40A, 32A, 2", 1-1/2"	83	83	250A	8A, 1/2", 3/8", 1/4"	110	180
	8A, 1/2", 3/8", 1/4"	61	71		25A, 20A, 15A, 10A, 1", 3/4"	130	190
	25A, 20A, 15A, 10A, 1-1/4", 1", 3/4", 5/8"	72	79		50A, 40A, 32A	150	200
	50A, 40A, 32A, 2", 1-1/2"	88	90		100A, 80A, 65A	170	210
80A	2-1/2"	97	97	150A, 125A	190	220	
	8A, 1/2", 3/8", 1/4"	61	77	200A	210	240	
	25A, 20A, 15A, 10A, 1-1/4", 1", 3/4", 5/8"	72	85	300A	8A, 1/2", 3/8", 1/4"	120	200
	50A, 40A, 32A, 2", 1-1/2"	88	96		25A, 20A, 15A, 10A, 1", 3/4"	140	210
65A, 3", 2-1/2"	103	103	50A, 40A, 32A		160	220	
8A, 1/2", 3/8", 1/4"	61	90	100A, 80A, 65A		180	230	
100A	25A, 20A, 15A, 10A, 1-1/4", 1", 3/4", 5/8"	72	98	150A, 125A	200	240	
	50A, 40A, 32A, 2", 1-1/2"	88	109	200A	220	260	
	80A, 65A, 4", 3", 2-1/2"	116	116				

ASTM TUBE (Inch Size)

D1	D2	C	M	D1	D2	C	M
3/8"	1/4"	37	37	3'	1/2", 3/8", 1/4", 8A	61	71
1/2"	3/8", 1/4"	39	39		1-1/4", 1", 3/4", 5/8", 25A, 20A, 15A, 10A	72	79
5/8"	1/2", 3/8", 1/4", 8A	47	44		2", 1-1/2", 50A, 40A, 32A	90	90
3/4"	1/2", 3/8", 1/4", 8A	47	44	4"	2-1/2", 65A	97	97
	5/8", 10A	52	52		1/2", 3/8", 1/4", 8A	61	87
1"	1/2", 3/8", 1/4", 8A	47	47		1-1/4", 1", 3/4", 5/8", 25A, 20A, 15A, 10A	72	95
	3/4", 5/8", 15A, 10A	55	55		2", 1-1/2", 50A, 40A, 32A	90	105
1-1/4"	1/2", 3/8", 1/4", 8A	47	50	3", 2-1/2", 80A, 65A	110	110	
	1", 3/4", 5/8", 20A, 15A, 10A	59	59	1/2", 3/8", 1/4", 8A	70	100	
1-1/2"	1/2", 3/8", 1/4", 8A	57	54	5"	1-1/4", 1", 3/4", 5/8", 25A, 20A, 15A, 10A	90	110
	1-1/4", 1", 3/4", 5/8", 25A, 20A, 15A, 10A	68	62		2", 1-1/2", 50A, 40A, 32A	110	120
2"	1/2", 3/8", 1/4", 8A	57	57		4", 3", 2-1/2", 100A, 80A, 65A	140	140
	1-1/4", 1", 3/4", 5/8", 25A, 20A, 15A, 10A	68	65	1/2", 3/8", 1/4", 8A	80	115	
	1-1/2", 40A, 32A	77	77	1-1/4", 1", 3/4", 5/8", 25A, 20A, 15A, 10A	100	125	
2-1/2"	1/2", 3/8", 1/4", 8A	61	63	6"	2", 1-1/2", 50A, 40A, 32A	120	135
	1-1/4", 1", 3/4", 5/8", 25A, 20A, 15A, 10A	72	71		4", 3", 2-1/2", 100A, 80A, 65A	140	145
	2", 1-1/2", 50A, 40A, 32A	90	83		5", 125A	160	160

NOTE:
 ·Dimensions and Drawings are for reference only and are subject to change without prior notice.
 ·Unless otherwise specified, all dimensions are in millimeters.

RC Concentric Reducer

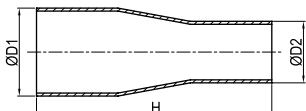

AUTO WELDING TYPE
(8A~100A)

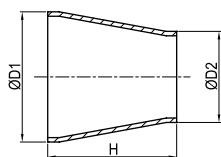

MANUAL WELDING TYPE
(125A ~ 200A)

Auto Welding Type

JIS PIPE (A Size)					
D1	D2	H	D1	D2	H
20A	15A	105	50A	40A, 32A, 25A	140
25A	20A, 15A	120	65A	50A, 40A, 32A	165
32A	25A, 20A, 15A	125	80A	65A, 50A, 40A	170
40A	32A, 25A, 20A	130	100A	80A, 65A, 50A	180

Mechanical Working Type

JIS PIPE (A Size)					
D1	D2	H	D1	D2	H
15A	3/4", 1/2"	100	32A	1-1/2", 1-1/4", 1"	125
20A	1", 3/4", 1/2"	105	40A	1-1/2", 1-1/4", 1", 3/4", 1/2", 3/8"	130
25A	1", 3/4", 1/2", 3/8" 1/4"	120	50A	2", 1-1/2", 1-1/4", 1", 3/4"	140

Manual Welding of Large DIA. Side X Automatic Welding of Small DIA. Side Type

JIS PIPE (A Size)		
D1	D2	H
125A	100A, 80A, 65A, 50A	190
150A	100A, 80A, 65A	205
200A	100A	220

Manual Welding Type

JIS PIPE (A Size)					
D1	D2	H	D1	D2	H
150A	125A	139.7	250A	200A, 150A, 125A	177.8
200A	150A, 125A	152.4	300A	250A, 200A, 150A, 125A	203.2

NOTE:

·Dimensions and Drawings are for reference only and are subject to change without prior notice.
·Unless otherwise specified, all dimensions are in millimeters.

REB Eccentric Reducer

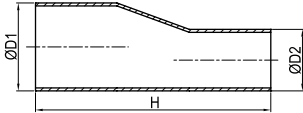

AUTO WELDING TYPE
(8A~100A)

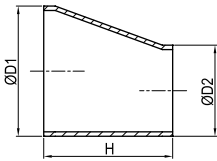

MANUAL WELDING TYPE
(125A ~ 200A)

Auto Welding Type

JIS PIPE (A Size)					
D1	D2	H	D1	D2	H
20A	15A	105	50A	40A, 32A, 25A	140
25A	20A, 15A	120	65A	50A, 40A, 32A	165
32A	25A, 20A, 15A	125	80A	65A, 50A, 40A	170
40A	32A, 25A, 20A	130	100A	80A, 65A, 50A	180

Mechanical Working Type

JIS PIPE (A Size)					
D1	D2	H	D1	D2	H
15A	3/4", 1/2"	100	32A	1-1/2", 1-1/4", 1"	125
20A	1", 3/4", 1/2"	105	40A	1-1/2", 1-1/4", 1", 3/4", 1/2", 3/8"	130
25A	1", 3/4", 1/2", 3/8", 1/4"	120	50A	2", 1-1/2", 1-1/4", 1", 3/4"	140

Manual Welding of Large DIA. Side X Automatic Welding of Small DIA. Side Type

JIS PIPE (A Size)		
D1	D2	H
125A	100A, 80A, 65A, 50A	190
150A	100A, 80A, 65A	205
200A	100A	220

Manual Welding Type

JIS PIPE (A Size)					
D1	D2	H	D1	D2	H
150A	125A	139.7	250A	200A, 150A, 125A	177.8
200A	150A, 125A	152.4	300A	250A, 200A, 150A, 125A	203.2

CPB Cap

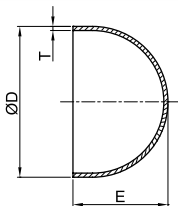

JIS PIPE (A Size)																
D	8A	10A	15A	20A	25A	32A	40A	50A	65A	80A	100A	125A	150A	200A	250A	300A
E	12.7	19.1	25.4	25.4	38.1	38.1	38.1	38.1	38.1	50.8	63.5	76.2	88.9	101.6	127.0	152.4
T	1.20	1.20	1.65	1.65	1.65	1.65	1.65	1.65	2.10	2.10	2.10	3.40	3.40	4.00	4.00	4.50

ASTM TUBE (Inch Size)												
D	1/4"	3/8"	1/2"	5/8"	3/4"	1"	1-1/4"	1-1/2"	2"	2-1/2"	3"	4"
E	12.7	12.7	12.7	12.7	19.1	25.4	38.1	38.1	38.1	38.1	38.1	63.5
T	1.00	1.00	1.24	1.24	1.65	1.65	1.65	1.65	1.65	1.65	1.65	2.11

NOTE:
·Dimensions and Drawings are for reference only and are subject to change without prior notice.
·Unless otherwise specified, all dimensions are in millimeters.

CPR Cap Reducer

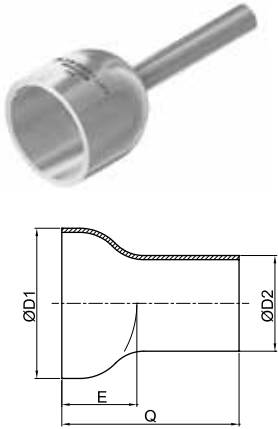

JIS PIPE (A Size)

D1	D2	E	Q	D1	D2	E	Q
15A	8A, 1/2", 3/8", 1/4"	25.4	60	125A	8A, 1/2", 3/8", 1/4"	76.2	120
	10A, 3/4", 5/8"		(67)		130		
20A	8A, 1/2", 3/8", 1/4"	25.4	60		25A, 20A, 15A, 10A, 1-1/4", 1", 3/4", 5/8"		140
	15A, 10A, 1", 3/4", 5/8"		67		(150)		
25A	8A, 1/2", 3/8", 1/4"	38.1	73	150A	8A, 1/2", 3/8", 1/4"	88.9	130
	20A, 15A, 10A, 1-1/4", 1", 3/4", 5/8"		(80)		140		
32A	8A, 1/2", 3/8", 1/4"	38.1	73		25A, 20A, 15A, 10A, 1-1/4", 1", 3/4", 5/8"		150
	25A, 20A, 15A, 10A, 1-1/4", 1", 3/4", 5/8"		80		160		
40A	8A, 1/2", 3/8", 1/4"	38.1	73	200A	8A, 1/2", 3/8", 1/4"	101.6	140
	25A, 20A, 15A, 10A, 1-1/4", 1", 3/4", 5/8"		80		150		
	32A, 1-1/2"		(90)		160		
50A	8A, 1/2", 3/8", 1/4"	38.1	73		100A, 80A, 65A, 4", 3", 2-1/2"		170
25A, 20A, 15A, 10A, 1-1/4", 1", 3/4", 5/8"	80		250A	8A, 1/2", 3/8", 1/4"	170		
40A, 32A, 2", 1-1/2"	(90)			25A, 20A, 15A, 10A, 1", 3/4"	180		
60A	8A, 1/2", 3/8", 1/4"	38.1	73	50A, 40A, 32A	190		
	25A, 20A, 15A, 10A, 1-1/4", 1", 3/4", 5/8"		80	100A, 80A, 65A,	200		
	50A, 40A, 32A, 2", 1-1/2"		(90)	300A	8A, 1/2", 3/8", 1/4"	200	
2-1/2"	(100)	25A, 20A, 15A, 10A, 1", 3/4"	210				
80A	8A, 1/2", 3/8", 1/4"	50.8	85		50A, 40A, 32A	220	
25A, 20A, 15A, 10A, 1-1/4", 1", 3/4", 5/8"	92		100A, 80A, 65A	230			
50A, 40A, 32A, 2", 1-1/2"	(110)						
100A	8A, 1/2", 3/8", 1/4"	63.5	98				
	25A, 20A, 15A, 10A, 1-1/4", 1", 3/4", 5/8"		105				
	50A, 40A, 32A, 2", 1-1/2"		115				
	80A, 65A, 4", 3", 2-1/2"		125				

ASTM TUBE (Inch Size)

D1	D2	E	Q	D1	D2	E	Q
3/4"	1/2", 3/8", 1/4", 8A	19.1	54	2-1/2"	1/2", 3/8", 1/4", 8A	38.1	73
	5/8", 10A		60		1-1/4", 1", 3/4", 5/8", 25A, 20A, 15A, 10A		80
1"	1/2", 3/8", 1/4", 8A	25.4	60		2", 1-1/2", 50A, 40A, 32A		(90)
	3/4", 5/8", 15A, 10A		67		1/2", 3/8", 1/4", 8A		73
1-1/4"	1/2", 3/8", 1/4", 8A	38.1	73	3"	1-1/4", 1", 3/4", 5/8", 25A, 20A, 15A, 10A	38.1	80
	1", 3/4", 5/8", 20A, 15A, 10A		80		2", 1-1/2", 50A, 40A, 32A		(90)
1-1/2"	1/2", 3/8", 1/4", 8A	38.1	73		2-1/2"		(95)
	1-1/4", 1", 3/4", 5/8", 25A, 20A, 15A, 10A		80		1/2", 3/8", 1/4", 8A		98
2"	1/2", 3/8", 1/4", 8A	38.1	73	4"	1-1/4", 1", 3/4", 5/8", 25A, 20A, 15A, 10A	63.5	105
	1-1/4", 1", 3/4", 5/8", 25A, 20A, 15A, 10A		80		2", 1-1/2", 50A, 40A, 32A		115
	1-1/2", 40A, 32A		(90)		3", 2-1/2", 80A, 65A		(125)

NOTE:
 ·Dimensions and Drawings are for reference only and are subject to change without prior notice.
 ·Unless otherwise specified, all dimensions are in millimeters.

JTM Joint Tee (Male)

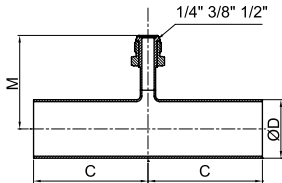

JIS PIPE (A Size)

D	8A	10A	15A	20A	25A	32A	40A	50A	65A	80A	100A	125A	150A	200A
C	45	52	52	55	59	68	68	68	72	72	72	100	110	120
M	45	47	49.5	52.5	56.5	61	64	70	78	84.5	97	110	123	148.5

ASTM TUBE (Inch Size)

D	1/4"	3/8"	1/2"	5/8"	3/4"	1"	1-1/4"	1-1/2"	2"	2-1/2"	3"	4"	5"	6"
C	43	45	45	52	52	55	59	68	68	72	72	72	90	100
M	41.5	43.5	45	46.5	48	52	55.5	58	65	72.5	78	91	104	117

JTF Joint Tee (Female)

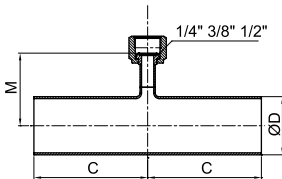

JIS PIPE (A Size)

D	8A	10A	15A	20A	25A	32A	40A	50A	65A	80A	100A	125A	150A	200A
C	45	52	52	55	59	68	68	68	72	72	72	100	110	120
M	35	37	39.5	42.5	46.5	51	54	60	68	74.5	87	100	113	138.5

ASTM TUBE (Inch Size)

D	1/4"	3/8"	1/2"	5/8"	3/4"	1"	1-1/4"	1-1/2"	2"	2-1/2"	3"	4"	5"	6"
C	43	45	45	52	52	55	59	68	68	72	72	72	90	100
M	31.5	33.5	35	36.5	38	42	45.5	48	55	61.5	68	81	94	107

JRM Joint Reducer (Male)

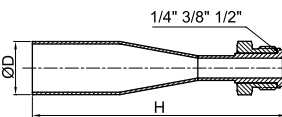

JIS PIPE (A Size)

D	8A	10A	15A	20A	25A
H	90	100	110	115	130

ASTM TUBE (Inch Size)

D	3/8"	1/2"	5/8"	3/4"	1"
H	80	85	100	110	115

NOTE:
 ·Dimensions and Drawings are for reference only and are subject to change without prior notice.
 ·Unless otherwise specified, all dimensions are in millimeters.

JRF Joint Reducer (Female)

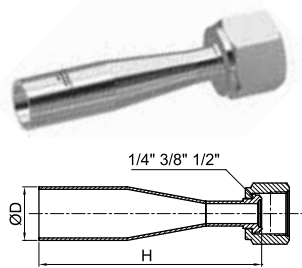

JIS PIPE (A Size)					
D	8A	10A	15A	20A	25A
H	90	100	110	115	130

ASTM TUBE (Inch Size)					
D	3/8"	1/2"	5/8"	3/4"	1"
H	80	85	100	110	115

JCPM Joint Cap (Male)

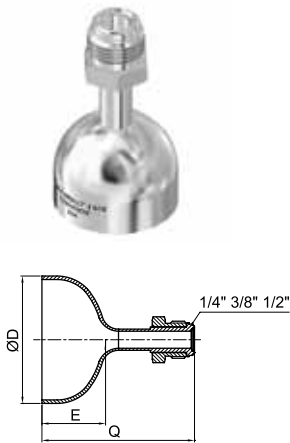

JIS PIPE (A Size)													
D	10A	15A	20A	25A	32A	40A	50A	65A	80A	100A	125A	150A	200A
E	19.1	25.4	25.4	38.1	38.1	38.1	38.1	38.1	50.8	63.5	76.2	88.9	101.6
M	58.0	65.0	65.0	78.0	78.0	78.0	78.0	78.0	91.0	104.0	117.0	130.0	143.0

ASTM TUBE (Inch Size)									
D	3/4"	1"	1-1/4"	1-1/2"	2"	2-1/2"	3"	4"	
E	19.1	25.4	38.1	38.1	38.1	38.1	38.1	63.5	
M	58	65.0	78.0	78.0	78.0	78.0	78.0	104.0	

JCPF Joint Cap (Female)

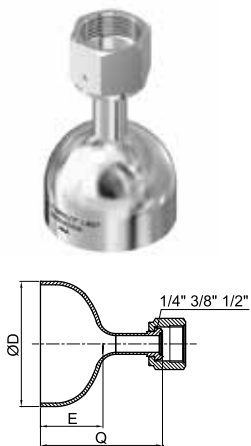

JIS PIPE (A Size)													
D	10A	15A	20A	25A	32A	40A	50A	65A	80A	100A	125A	150A	200A
E	19.1	25.4	25.4	38.1	38.1	38.1	38.1	38.1	50.8	63.5	76.2	88.9	101.6
M	48.0	55.0	55.0	68.0	68.0	68.0	68.0	68.0	81.0	94.0	107.0	120.0	133.0

ASTM TUBE (Inch Size)									
D	3/4"	1"	1-1/4"	1-1/2"	2"	2-1/2"	3"	4"	
E	19.1	25.4	38.1	38.1	38.1	38.1	38.1	63.5	
M	45	55.0	68.0	68.0	68.0	68.0	68.0	94.0	

NOTE:
 ·Dimensions and Drawings are for reference only and are subject to change without prior notice.
 ·Unless otherwise specified, all dimensions are in millimeters.

GTT Teflon Gasket

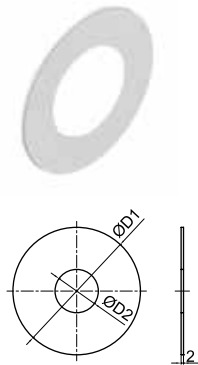

JIS PIPE (A Size)

JIS 10K

D*	10A	15A	20A	25A	32A	40A	50A	65A	80A	100A	125A	150A	200A	250A	300A
D1	53	58	63	76	84	89	104	124	134	159	190	220	270	333	378
D2	18	22	28	35	43	49	61	77	90	115	141	167	218	270	321

JIS 5K

D*	10A	15A	20A	25A	32A	40A	50A	65A	80A	100A	125A	150A	200A	250A	300A
D1	45	50	55	65	78	83	93	118	129	149	184	214	260	325	370
D2	18	22	28	35	43	49	61	77	90	115	141	167	218	270	321

ASTM TUBE (Inch Size)

D*	3/4"	1"	1-1/4"	1-1/2"	2"	2 1/2"	3"	4"	5"	6"
D1	58	63	74	84	89	104	124	144	190	220
D2	19.5	26	32.5	38.5	51.5	64	77	102.5	128	153.5

*D: Flange Size

FLJ Lap Joint Flange

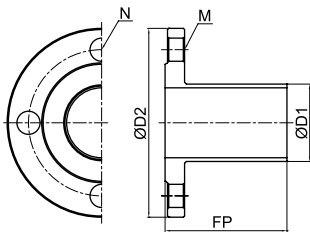

JIS PIPE (A Size)

	10A	15A	20A	25A	32A	40A	50A	65A	80A	100A	125A	150A	200A	250A	300A
D1	90	95	100	125	135	140	155	175	185	210	250	280	330	400	445
D2	100	100	100	100	100	100	100	100	100	100	200	200	200	200	200
FP	4	4	4	4	4	4	4	4	8	8	8	8	12	12	16
N	M12	M12	M12	M16	M16	M16	M16	M16	M16	M16	M20	M20	M20	M22	M22

ASTM TUBE (Inch Size)

	3/4"	1"	1-1/4"	1-1/2"	2"	2-1/2"	3"	4"	5"	6"
D1	95	100	125	135	140	155	175	195	250	280
D2	100	100	100	100	100	100	100	100	200	200
FP	4	4	4	4	4	4	4	8	8	8
N	M12	M12	M16	M16	M16	M16	M16	M16	M20	M20

NOTE:

·Dimensions and Drawings are for reference only and are subject to change without prior notice.
·Unless otherwise specified, all dimensions are in millimeters.

FRF RF Flange

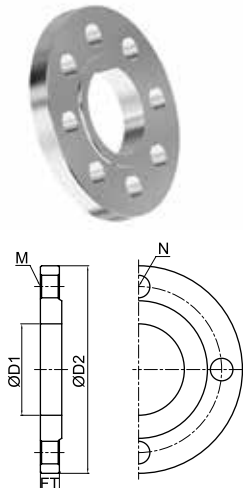

JIS PIPE (A Size)_JIS 10K

D1	10A	15A	20A	25A	32A	40A	50A	65A	80A	100A	125A	150A	200A	250A	300A
D2	90	95	100	125	135	140	155	175	185	210	250	280	330	400	445
FT	12	12	14	14	16	16	16	18	18	18	20	22	22	24	24
N	4	4	4	4	4	4	4	4	8	8	8	8	12	12	16
M	M12	M12	M12	M16	M16	M16	M16	M16	M16	M16	M20	M20	M20	M22	M22

JIS PIPE (A Size)_JIS 5K

D1	10A	15A	20A	25A	32A	40A	50A	65A	80A	100A	125A	150A	200A	250A	300A
D2	75	80	85	95	115	120	130	155	180	200	235	265	320	385	430
FT	9	9	10	10	12	12	14	14	14	16	16	18	20	22	22
N	4	4	4	4	4	4	4	4	4	8	8	8	8	12	12
M	M10	M10	M10	M10	M12	M12	M12	M12	M16	M16	M16	M16	M20	M20	M20

ASTM TUBE (Inch Size)

D1	3/4"	1"	1-1/4"	1-1/2"	2"	2-1/2"	3"	4"	5"	6"
D2	95	100	125	135	140	155	175	195	250	280
FT	12	14	14	16	16	16	18	18	20	22
N	4	4	4	4	4	4	4	8	8	8
M	M12	M12	M16	M16	M16	M16	M16	M16	M20	M20

FB Blind Flange

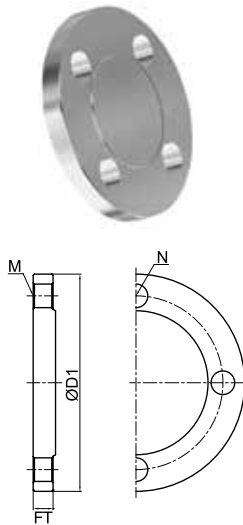

JIS PIPE (A Size)_JIS 10K

D*	10A	15A	20A	25A	32A	40A	50A	65A	80A	100A	125A	150A	200A	250A	300A
D1	90	95	100	125	135	140	155	175	185	210	250	280	330	400	445
FT	12	12	14	14	16	16	16	18	18	18	20	22	22	24	24
N	4	4	4	4	4	4	4	4	8	8	8	8	12	12	16
M	M12	M12	M12	M16	M16	M16	M16	M16	M16	M16	M20	M20	M20	M22	M22

JIS PIPE (A Size)_JIS 5K

D*	10A	15A	20A	25A	32A	40A	50A	65A	80A	100A	125A	150A	200A	250A	300A
D1	75	80	85	95	115	120	130	155	180	200	235	265	320	385	430
FT	9	9	10	10	12	12	14	14	14	16	16	18	20	22	22
N	4	4	4	4	4	4	4	4	4	8	8	8	8	12	12
M	M10	M10	M10	M10	M12	M12	M12	M12	M16	M16	M16	M16	M20	M20	M20

ASTM TUBE (Inch Size)

D*	3/4"	1"	1-1/4"	1-1/2"	2"	2-1/2"	3"	4"	5"	6"
D1	95	100	125	135	140	155	175	195	250	280
FT	12	14	14	16	16	16	18	18	20	22
N	4	4	4	4	4	4	4	8	8	8
M	M12	M12	M16	M16	M16	M16	M16	M16	M20	M20

*D: Flange Size

NOTE:
 ·Dimensions and Drawings are for reference only and are subject to change without prior notice.
 ·Unless otherwise specified, all dimensions are in millimeters.

LJ Lap Joint

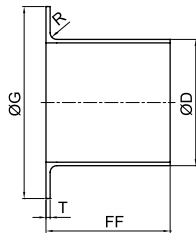

JIS PIPE (A Size)

D	10A	15A	20A	25A	32A	40A	50A	65A	80A	100A	125A	150A	200A	250A	300A	
FF	55	55	55	55	70	70	70	75	75	75	50	50	65	65	65	
G	JIS 10K	46	51	56	67	76	81	96	116	126	151	182	212	262	324	368
	JIS 5K	39	44	49	59	70	75	85	110	121	141	182	212	262	324	368
R	3	3	3	3	3	3	4	4	5	5	5	5	5	5	5	
T	2.5	2.5	2.5	2.5	2.5	2.5	2.5	2.5	2.5	2.5	5	5	7	7	9	

ASTM TUBE (Inch Size)

D	3/4"	1"	1-1/4"	1-1/2"	2"	2-1/2"	3"	4"	5"	6"
FF	55	55	55	70	70	70	75	75	85	90
G	51	56	67	76	81	96	116	136	182	212
R	3	3	3	3	3	4	4	5	5	5
T	2.5	2.5	2.5	2.5	2.5	2.5	2.5	2.5	3	3

TMH Multi-Header Tee

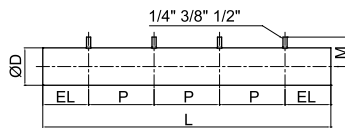

JIS PIPE (A Size)

D		8A	10A	15A	20A	25A	32A	40A	50A	65A	80A	100A	
Length at End (EL)		23	29	31	34	42	46	49	60	68	74.5	87	
Pitch(P)		125									145		
L*	Number of Branches	2	245									285	
		3	370									430	
		4	495									575	
		5	620									720	
M*	Tube-End	42	44	44	47	50	54	57	63	71	77	90	

ASTM TUBE (Inch Size)

D		1/4"	3/8"	1/2"	5/8"	3/4"	1"	1-1/4"	1-1/2"	2"	2-1/2"	3"	4"
Length at End (EL)		21.0	21.0	21.0	27.0	30.0	33.0	40.0	45.0	50.0	65.0	68.0	86.0
Pitch (P)		152.4											
L*	Number of Branches	2	304.8										
		3	457.2										
		4	609.6										
		5	762.0										
M*	Tube-End	35	37	39	44	44	47	50	54	57	63	71	87

*M: Branch Tube Height

*L: Total Length

NOTE:

·Dimensions and Drawings are for reference only and are subject to change without prior notice.
·Unless otherwise specified, all dimensions are in millimeters.

TMHJ Multi-Header Joint Tee

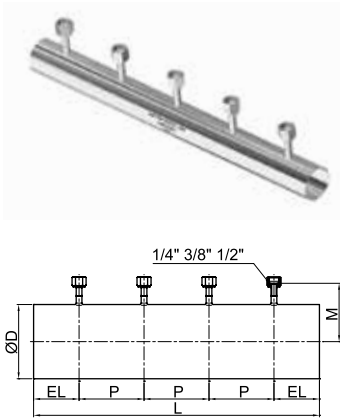

JIS PIPE (A Size)												
D		8A	10A	15A	20A	25A	32A	40A	50A	65A	80A	100A
Length at End (EL)		23	29	31	34	42	46	49	60	68	74.5	87
Pitch (P)		125								145		
L*	Number of Branches	2	245								285	
		3	370								430	
		4	495								575	
		5	620								720	
M*	Female	35	37	39.5	42.5	46.5	51	54	60	68	74.5	87

ASTM TUBE (Inch Size)														
D		1/4"	3/8"	1/2"	5/8"	3/4"	1"	1-1/4"	1-1/2"	2"	2-1/2"	3"	4"	
Length at End (EL)		21	21	21	27	30	33	40	45	50	65	68	86	
Pitch(P)		154.4												
L*	Number of Branches	2	304.8											
		3	457.2											
		4	609.6											
		5	762.0											
M*	Female	31.5	33.5	35	36.5	38	42	45.5	48	55	61.5	68	81	

*M: Branch Tube Height
*L: Total Length

NOTE:
·Dimensions and Drawings are for reference only and are subject to change without prior notice.
·Unless otherwise specified, all dimensions are in millimeters.